

CZECH TECHNICAL UNIVERSITY IN PRAGUE
Faculty of Electrical Engineering

BACHELOR THESIS

2019

Štěpán Šubík

Czech Technical University in Prague
Faculty of Electrical Engineering
Department of telecommunication engineering

Bachelor thesis

**Resource Allocation for Communication with Multi-Access Edge
Computing Exploiting Device to Device Relaying**

Štěpán Šubík

Supervisor: Ing. Jan Plachý

May 2019

Declaration

I hereby declare that I have completed this thesis independently and that I have listed all the literature and publications used.

I have no objection to the usage of this work in compliance with the act §60 Zákon č. 121/2000Sb. (copyright law), and with the rights connected with the copyright act including the changes in the act.

Prague, 24.5.2019

.....

Acknowledgement

I would like to thank my supervisor, Ing. Jan Plachý, for his guidance and all the advice he provided me during the work on this thesis. I am grateful for his support and positive attitude, which encouraged me to work on this thesis.

I. OSOBNÍ A STUDIJNÍ ÚDAJE

Příjmení: **Šubík** Jméno: **Štěpán** Osobní číslo: **459937**
Fakulta/ústav: **Fakulta elektrotechnická**
Zadávající katedra/ústav: **Katedra telekomunikační techniky**
Studijní program: **Komunikace, multimédia a elektronika**
Studijní obor: **Sít'ové a informační technologie**

II. ÚDAJE K BAKALÁŘSKÉ PRÁCI

Název bakalářské práce:

Přidělování prostředků pro komunikaci s Multi-Access Edge Computing využívající okolních zařízení pro přenos dat

Název bakalářské práce anglicky:

Resource Allocation for Communication with Multi-Access Edge Computing Exploiting Device to Device Relaying

Pokyny pro vypracování:

Seznamte se s Multi-Access Edge Computing (MEC) a metodami pro výběr komunikačních cest, včetně možnosti využití přímé komunikace (D2D) s okolními zařízeními pro doručení dat. Na základě existující literatury navrhnete algoritmus pro výběr komunikační cesty s využitím D2D komunikace. Zvolte vhodné metriky a porovnejte efektivitu navrženého řešení s existujícími řešeními.

Seznam doporučené literatury:

- [1] P. Mach, Z. Becvar, "Mobile Edge Computing: A Survey on Architecture and Computation Offloading," IEEE Communications Surveys & Tutorials 2017.
- [2] J. Plachy, Z. Becvar, P. Mach, "Path Selection Enabling User Mobility and Efficient Distribution of Data for Computation at the Edge of Mobile Network," Computer Networks, vol. 108, 2016.
- [3] Y. Li, L. Sun and W. Wang, "Exploring Device-to-Device Communication for Mobile Cloud Computing," IEEE International Conference on Communications (ICC), Sydney, NSW, 2014, pp. 2239-2244.

Jméno a pracoviště vedoucí(ho) bakalářské práce:

Ing. Jan Plachý, katedra telekomunikační techniky FEL

Jméno a pracoviště druhé(ho) vedoucí(ho) nebo konzultanta(ky) bakalářské práce:

Datum zadání bakalářské práce: **11.01.2018**

Termín odevzdání bakalářské práce: **24.05.2019**

Platnost zadání bakalářské práce: **30.09.2019**

Ing. Jan Plachý
podpis vedoucí(ho) práce

podpis vedoucí(ho) ústavu/katedry

prof. Ing. Pavel Ripka, CSc.
podpis děkana(ky)

III. PŘEVZETÍ ZADÁNÍ

Student bere na vědomí, že je povinen vypracovat bakalářskou práci samostatně, bez cizí pomoci, s výjimkou poskytnutých konzultací. Seznam použité literatury, jiných pramenů a jmen konzultantů je třeba uvést v bakalářské práci.

Datum převzetí zadání

Podpis studenta

Summary

The convergence of communication and computing led to the introduction of Multi-Access Edge Computing (MEC), which provides users with the possibility to exploit computing resources at the “edge” of the mobile network to offload processing of their applications. With the strict requirements of the mobile users on the offloading delay, Device to Device (D2D) communication can provide a way to reduce the offloading delay. In this thesis, an algorithm for selection of the communication path with D2D communication for the MEC is proposed. Using a simulation, the proposed algorithm exploiting D2D communication is evaluated and compared to communication without D2D communication. It is shown that the proposed algorithm leads to lower offloading delay and energy consumption.

Key words: Device to Device communication, Multi-Access Edge Computing, 5G, offloading delay, data rate

Anotace

Konvergence mobilní komunikace a výpočetních prostředků vedla ke vzniku Multi-Access Edge Computingu (MEC), jež umožňuje mobilním uživatelům pro zpracování dat využít výpočetní prostředky na hraně mobilní sítě. Striktní požadavky mobilních uživatelů na zpoždění při využití těchto prostředků na hraně je možno splnit pomocí Device to Device (D2D) komunikace. Tato práce se zabývá návrhem algoritmu pro výběr komunikační cesty pro MEC s využitím D2D komunikace. Navržený algoritmus je porovnán s komunikací bez možnosti využití D2D komunikace. V porovnání je ukázáno, že s použitím navrženého algoritmu dochází ke snížení komunikačního zpoždění a spotřeby energie uživatelských zařízení při využití MEC.

Klíčová slova: Device to Device komunikace, Multi-Access Edge Computing, 5G, zpoždění, datová propustnost

Contents

1.	Introduction	1
2.	Mobile networks.....	3
2.1.	Evolution of mobile networks.....	3
2.1.1.	5G mobile networks.....	4
3.	Multi-Access Edge Computing with Device to Device Relaying.....	5
3.1.	Multi-Access Edge Computing (MEC)	5
3.1.1.	Evolution of the MEC from the MCC	5
3.1.2.	Offloading procedure for the MEC	7
3.1.3.	Selection of communication paths	8
3.2.	Device to Device (D2D) communication.....	9
3.2.1.	Use cases.....	9
3.2.1.1.	Local data service.....	9
3.2.1.2.	Coverage extension	9
3.2.1.3.	Machine to Machine (M2M) communication.....	10
3.3.	MEC with D2D relaying	11
4.	Simulation models and scenarios	12
4.1.	User mobility model	12
4.2.	Path Loss (PL) models	13
4.3.	Resource allocation	14
4.4.	User data rate	15
4.5.	Energy consumption model.....	16
4.6.	Algorithm for selection of the communication path.....	17
5.	Simulation results	20
5.1.	Offloading delay.....	20
5.2.	Number of offloaded tasks	22
5.3.	The ratio of tasks offloaded with D2D relaying	22
5.4.	Number of unsuccessful offloaded tasks with D2D relaying.....	24
5.5.	Energy Consumption.....	25
6.	Conclusion.....	28
7.	References	29

1. Introduction

Mobile networks, providing users with the possibility to communicate without being fixed to one position, are continuously evolving to meet users demands on communication. Users requirements are evolving as well, due to the introduction of new services, e.g. virtual reality or augmented reality, or enhancements of the already existing ones, e.g. higher audio or video quality. As a consequence of the evolution of users demands, total data traffic in mobile networks increases rapidly. For example, between Q4 2017 and Q4 2018 total data traffic increased by 88 % [1]. Mobile networks facilitate communication not only to public users but also to many businesses like industry, medical services, transportation, entertainment or advertising. In these businesses, the novel mobile network services can accelerate their growth.

Currently deployed fourth generation (4G) mobile networks are soon to be upgraded to the next generation of mobile networks, i.e. fifth generation (5G) mobile networks. The 5G mobile networks focus on three primary areas: enhanced Mobile Broadband (eMBB), massive Machine Type Communications (mMTC) and Ultra Reliable Low Latency Communication (URLLC). The 5G mobile networks should enable peak data rates of up to 20 Gb/s and low end to end communication latencies of 1 ms or even below. Furthermore, 5G mobile networks are to provide energy and spectrum efficient communication to the densely deployed user equipments (UEs), e.g. laptops, tablets or smartphones. Apart from the high density of the UEs, mobile users with speed up to 500 km/h are to be supported as well [2].

The features of the 5G mobile networks will facilitate the expansion of smart cities, autonomous driving, industry automation, virtual reality, augmented reality, as well, as working and playing in the cloud and remote medical surgery [3]. These services do not require just a low communication delay (also known as latency) but sufficient computation power as well. The convergence of communication and computing leads to the introduction of Multi-Access Edge Computing (MEC) [4], [5], which enables computationally expensive tasks, such as games, virtual reality or augmented reality, to be offloaded, i.e. transferred to the cloud at the “edge” of the mobile network for processing (computing). Tasks offloading results in preserving UEs’ processing power for running less computationally demanding tasks and UEs’ battery savings.

The mobile UEs communicate with base stations (BSs), such as macro cell base stations (eNBs) or small cell base stations (SCeNBs). However, to decrease the communication delay for communication of the UEs, the concept of Device to Device (D2D) communication, enabling direct interaction between neighbouring UEs in proximity without eNBs or SCeNBs intervention, was brought in. D2D communication has been introduced for the 4G mobile networks in the

INTRODUCTION

Long Term Evolution – Advanced (LTE-A) standard [6]. Eventually, the D2D communication is expected to be one of the advantages of 5G mobile networks [2].

This thesis focuses on the minimisation of MEC offloading delay by the exploitation of D2D communication to avoid communication over low-quality channels. The novel approach is in deploying both the MEC and D2D communication in a single concept and showing its behaviour according to various simulation scenarios.

The rest of this paper is organised as follows. In the next chapter, the evolution of mobile networks is described. The MEC and D2D communication are elaborated in the chapter Multi-Access Edge Computing with Device to Device Relaying. In the chapter Simulation Models and Scenarios, a description of the simulation and its parameters is covered. The results of the simulation are summarised and evaluated in the chapter Simulation Results. In the last chapter, conclusion and future work are outlined.

2. Mobile networks

Connectivity to moving users, i.e. mobile users, is provided via mobile networks, also known as cellular networks. Mobile users are served by various types of BSs, which differ inter alia in their coverage areas. Two of the common BS types, based on their coverage areas, are eNBs and SCeNBs. To provide UEs access to the Internet, BSs are connected to the operator's core network using either metallic/optical conductors or wireless links. BSs use various radio technologies, providing different mobile network generations, and are deployed in many versions.

In order to achieve compatibility between BSs and mobile UEs hardware, standardisations and regulations must be done. The standardisation of mobile networks follows International Telecommunications Union's (ITU's) recommendations and standardisations, such as International Mobile Telecommunication system standards (IMT-2000, IMT-advanced, IMT-2020), specifying requirements on the mobile networks of the third, fourth and fifth generation (3G, 4G and 5G), respectively. Apart from the ITU, the standardisation is performed by European Telecommunications Standards Institute (ETSI), which standardises mobile communication for European Union and other countries, such as United States of America, Japan or the Peoples Republic of China. The ETSI is a partner in the international Third Generation Partnership Project (3GPP), which unites seven telecommunication standard development organisations. The 3GPP issues standards for cellular telecommunications network technologies including work on the radio interface, core network, security and quality of service. Third Generation Partnership Project 2 (3GPP2) is another standard body, which was formed as a competitor of the 3GPP issuing and submitting a rival standard for the 3G mobile networks to the ITU. Although there is no clear "winner" in terms of standardisation for the 3G mobile networks, in terms of the 4G mobile networks, 3GPP's standard is deployed worldwide, whereas 3GPP2 withdrew its 4G mobile networks standard proposal. The regulation of mobile networks is consequently made in each country individually by a national regulation entity.

2.1. Evolution of mobile networks

The first commercially automated mobile networks, the mobile networks of the first generation (1G) turned up in the 1980s. 1G mobile networks were based on analogue telecommunications standards. Nordic Mobile Telephone (NMT) was the standard used in Switzerland, Russia and North and Eastern Europe. Advanced Mobile Phone System (AMPS) was deployed in Western Europe, America and Australia.

MOBILE NETWORKS

The next generation of mobile networks, 2G, was launched in the 1990s. 2G mobile networks are the first digital mobile networks. The voice and message services are provided by Global System for Mobile Communication (GSM) standard from ETSI followed by the enablement of packet data transmission via General Packet Radio Service (GPRS). GPRS was then upgraded to Enhanced Data Rate for GSM Evolution (EDGE), which improved encoding and data rates.

With the deployment of the 3G mobile networks after the beginning of the new millennium, mobile networks had sped up noticeably. Universal Mobile Telecommunications Service (UMTS) standardised by 3GPP was deployed in Europe, Japan, the Peoples Republic of China and other regions predominated by GSM, whereas Code Division Multiple Access (CDMA2000) standardised by 3GPP2 was used mainly in North America and South Korea. Latest standard issued by 3GPP for the mobile networks of the third generation is Long Term Evolution (LTE), which does not comply with all the requirements on 4G mobile networks defined by ITU, and thus cannot be considered as 4G mobile networks.

The LTE-A, by 3GPP, added some improvements on top of LTE and was the first standard which met all the requirements of IMT-advanced from ITU.

2.1.1. 5G mobile networks

Recently, proposals for the 5G mobile networks are discussed, and new technologies standardised.

One of the three use cases defined for the 5G mobile networks in the Study on New Services and Markets Technology Enablers (SMARTER) by 3GPP [7], is the eMBB. The eMBB delivers three distinct attributes: 1) availability in densely populated areas, both indoors and outdoors, 2) ubiquitous access to provide consistent user experience, and 3) provision of service in moving vehicles including cars, buses, trains and planes [8]. With the URLLC, 5G mobile networks address applications which require a low end-to-end delay and high reliability, e.g. industrial control applications, remote surgery or autonomous vehicles. The third use case, the mMTC, assumes to enable more efficient communication to machines, e.g. sensors in smart cities and smart homes or e-health and smart wearables.

In order to fulfil all the mentioned goals, the state-of-the-art approaches such as D2D communication and the MEC should be implemented into 5G mobile networks.

3. Multi-Access Edge Computing with Device to Device Relaying

The emergence of the 5G mobile networks opens new services to mobile users. One of these services is the MEC, which provides UEs with computing resources at the “edge” of the mobile network. Thus, UEs can run computationally demanding tasks in the MEC, while exploiting D2D communication to improve the quality of the MEC service.

3.1. Multi-Access Edge Computing (MEC)

The state-of-the-art software and mobile applications, e.g. virtual reality or augmented reality, serve users with pervasive opportunities for education, productivity improvement and entertainment. To support these applications, UEs need to employ intensive computational resources, which results in high energy consumption of the UEs [9]. Since UEs have limited processing power, as well as battery capacity, the concept of offloading computationally demanding tasks to the Mobile Cloud Computing (MCC) [10] with abundant computing resources was introduced. The MCC supplies the UEs with computing resources located at data centres provided by the mobile operators.

3.1.1. Evolution of the MEC from the MCC

The MCC integrates the cloud computing capabilities into the mobile network (i.e. moves them closer to the UEs). The Figure 3.1 shows the structure of the mobile network with the MCC, where the UE (on the left), communicates with the MCC (on the right). Instead of exploiting data centres located far away in the Internet, with the MCC, computation of the offloaded task (i.e. computationally demanding task which is about to be offloaded) is executed in datacentres of a centralised cloud accessible via backhaul of the mobile network [11]. However, the MCC datacentres might still be located far from the UEs. Therefore, the usage of the MCC is limited by its applicability. The limitation comes from the communication delay caused by the distance between the UEs and the computing resources. Furthermore, the SCeNBs, which provide connectivity to the UEs, can be connected through a lower-quality backhaul compared to the standard optical fibre backhaul of the macro cell eNBs. This lower-quality interconnection leads to the significant offloading delay for the MCC [12].

MULTI-ACCESS EDGE COMPUTING WITH DEVICE TO DEVICE RELAYING

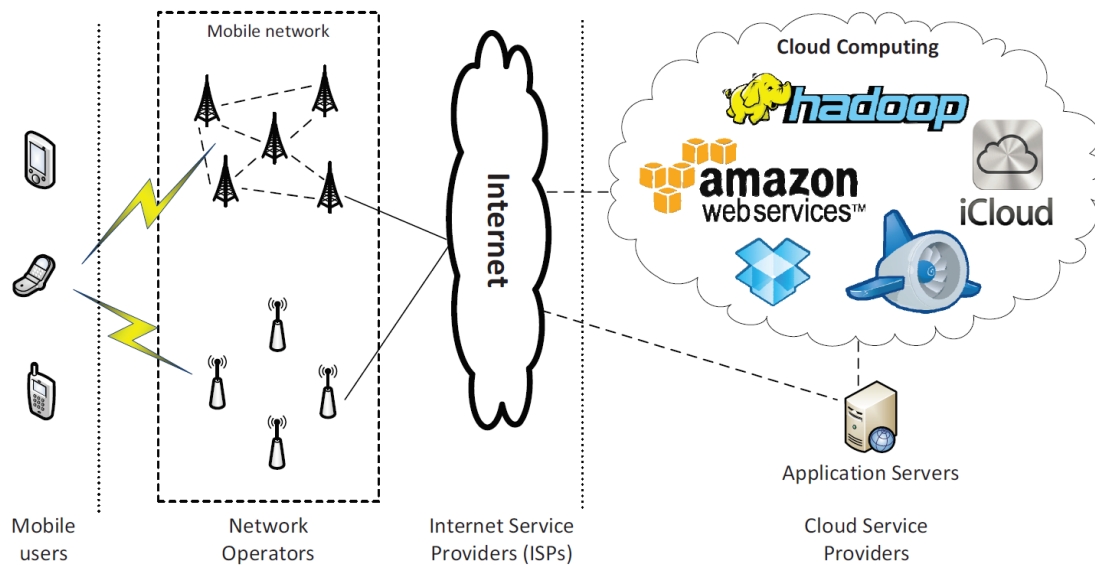

Figure 3.1 Mobile network with the MCC [13].

In order to lower the communication and offloading delay, computing resources can be moved closer to UEs, to the “edge” of the mobile network, which leads to the introduction of the MEC. The MEC processes offloaded tasks at eNBs or SCellNBs via computation resources, which are virtualised. The virtualisation exploits physical computing resources and provides them to the UEs as virtual computation resources (i.e. containers or virtual machines) [5]. An example of the MEC use case is shown in the Figure 3.2, where an AR application on the UE overlays augmented reality content onto objects viewed on the UE’s camera. Applications on the MEC server (i.e. eNBs or SCellNBs with the MEC) can provide local object tracking and local AR content caching, which minimises end-to-end delay and maximises data rate [14].

To sum up, by bringing computational resources closer to the user, the offloading delay is decreased from more than 100 ms in the MCC to tens of ms in the MEC [15] with 4G mobile networks. 5G networks expect to decrease offloading delay further to units of ms [2]. Furthermore, backhaul of eNBs or SCellNBs is less likely to be overloaded, since the communication of UEs with the MEC servers exploits mostly radio. Additionally, the MEC lowers energy consumption of UEs, in comparison to executing tasks locally in UEs [16].

MULTI-ACCESS EDGE COMPUTING WITH DEVICE TO DEVICE RELAYING

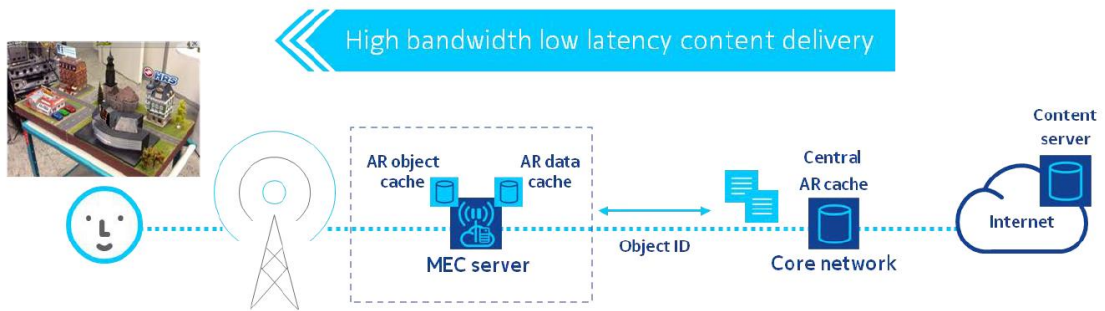

Figure 3.2 AR content delivery with the MEC [14].

3.1.2. Offloading procedure for the MEC

Offloading of user data to the MEC as well as collecting them back to the UE is a complex problem consisting of several steps. The procedure of offloading a task to the MEC goes as follows:

1) Request to process data

The UE requests to offload a computationally demanding application (offloaded task) in the MEC. Thus, the UE sends this request to the MEC orchestrator, which is the MEC managing entity [17].

2) Offloading decision process

The MEC orchestrator decides if it is beneficial to offload the requested offloaded task, and consequently where the offloaded task will be offloaded. This procedure is called an offloading decision, and it is based on the requested offloaded task's and offloading-decision-important parameters. These parameters are, for instance, the size of input and output of the offloaded task, the quality of communication link between the UE and its serving BS (i.e. channel quality for offloading and collecting), the number of instructions of the offloaded task and the available computing resources on the UE (i.e. time required to process the task on the UE) and in the MEC (i.e. time of computation in the MEC). Note, that even with the proximity of the UE and the MEC server, it is not always beneficial to offload the requested offloaded task to the MEC, as the MEC can be overloaded or the UE's channel quality is poor. Furthermore, the offloading decision can be based on additional requirements, such as the total offloading delay or offloading energy consumed by the UE by transmitting the offloaded task to the MEC and collection the processed results [4], [18]. Moreover, the offloading decision must be re-taken, to keep track of the tendency of the offloading-decision-important parameters, such as the uplink and downlink communication channels quality and

MULTI-ACCESS EDGE COMPUTING WITH DEVICE TO DEVICE RELAYING

available communication and computing resources of the MEC servers (since MEC resources are not necessarily placed at every eNB or SCellNB). The offloading decision is further complicated by the mobility of the UE and the consequent possibility of a handover occurrence.

3) *Offloading*

The requested offloaded task is offloaded if it is assessed to be advantageous for the UE according to the offloading decision. The offloading consists of transferring the input data from the UE to the MEC server via the UE's radio interface, and if necessary over the eNB's or SCellNB's backhaul if the processing is performed at another BS.

4) *Processing of the offloaded task*

The offloaded task is received by the MEC server and processed by the assigned computing resources.

5) *Collecting of the processed task*

After the offloaded task is processed, the output data are collected by the UE from the MEC server.

3.1.3. Selection of communication paths

The performance of the MEC is not only affected by the offloaded task's parameters, the quality of communication link between the UE and its serving BS, the number of instructions of the offloaded task and the available computing resources in the MEC, but also by the backhaul connection between the serving BS and the MEC in case that the MEC and BS are not collocated.

The mobile network's backhaul might be a significant bottleneck of the MEC as offloaded tasks generate additional load to the regular traffic. For this purpose, the Path Selection with Handover (PSwH) algorithm is proposed [19]. The PSwH algorithm estimates communication delay and energy consumed by the task transmission and selects the most suitable serving BS accordingly. The exploitation of the algorithm results in a reduction of the offloading delay and the UE's energy consumption. Moreover, PSwH algorithm significantly decreases backhaul load as UEs prefer to communicate with MEC servers directly than sending offloaded tasks to the MEC via backhaul.

Similar issue, with a selection of the communication path, is described in [20] for data offloading in vehicular communication. The authors provide an algorithm considering the trade-off between downloading data through pervasive but costly cellular networks and seldom but practically free WiFi access points provided by Roadside Units (RSUs). The optimal solution is analysed under the condition, that the encountering time between vehicles and RSUs follows the exponential and the Gaussian distribution. After an initial period of time, the optimal

MULTI-ACCESS EDGE COMPUTING WITH DEVICE TO DEVICE RELAYING

strategy is adjusted according to the previous experience. Eventually, it is shown using simulation experiments, that proposed algorithm increases user's satisfaction.

3.2. Device to Device (D2D) communication

The communication in mobile networks is commonly done by UE communicating with a BS. However, in 3GPP Release 12, D2D communication, enabling communication between two UEs without the need to communicate through the eNB or SCeNB, is introduced. However, until this 3GPP release, UEs could communicate directly only in unlicensed bands. These bands are used, for instance, by WiFi Direct [21] and Bluetooth [22]. The advantage of communication in unlicensed bands is the lack of regulation, which enables the use of these technologies in any way which is within the operating limits. Thus, communication in the unlicensed band should be ideally faster and cheaper in terms of cost per bit. The real drawback of the communication in unlicensed bands is the lack of interference control, which noticeably decreases quality of service (QoS) and therefore decreases communication data rate. Therefore, deployment of the D2D communication into a licensed band, i.e. mobile networks, complies with interference avoidance, which is handled by the communication resource allocation via the mobile network. Thus, low cost per bit, low communication delay, high reliability, and high data rate are ensured.

D2D communication might be applicable in various scenarios, i.e. improvement of mobile networks coverage in shadowed areas, after natural disasters, or providing location-based service such as local alerts from police or national weather service, or even during social events.

3.2.1. Use cases

The D2D communication can be exploited in multiple ways. Therefore, several use cases are provided.

3.2.1.1. Local data service

It is most likely that users in the same location, e.g. concerts, sports events, tourist information centres, share similar interests and thus enjoy the same sort of content. Then, sending data via unicast, broadcast or multicast to the UEs in a vicinity results in higher data rates and/or lower energy consumption compared to accessing these data via the conventional mobile networks. Local D2D communication utilisation is applicable during social events and networking, or in gaming, advertisement and transferring files and audio. An example of local data service is shown in the Figure 3.3, where the UE4 uses broadcast to share data with the UE3 and UE5.

3.2.1.2. Coverage extension

UEs are sometimes situated in areas with poor coverage, e.g. at the cell "edge" or in the disaster-hit area, or they are shadowed by obstacles, e.g. tree avenues, walls or vehicles. As far

MULTI-ACCESS EDGE COMPUTING WITH DEVICE TO DEVICE RELAYING

as the affected UE has a direct line of sight (LOS) to a neighbouring UE, so called D2D relaying might be used to relay affected UE's data [23], [24]. As shown in the Figure 3.3, the UE9 is shadowed by the tree avenue and thus has a worse channel quality to the base station (BS) than the UE6. Therefore, the UE6 acts like a relay for the UE9. Once the user of the UE9 wants to use mobile network services, e.g. look up something on the Internet, the creation of the D2D link UE9 – UE6 is followed by an entitlement to use the cellular link UE6 – BS for the UE9 – BS communication.

3.2.1.3. Machine to Machine (M2M) communication

M2M communication, exploiting D2D communication, provides a viable option of communication of machines, represented by sensors, controllers, actuators, as well as wearables, such as smartwatches. By exploiting D2D communication, the energy consumption of the UEs is reduced, which leads to a prolonged lifetime of the UEs [25].

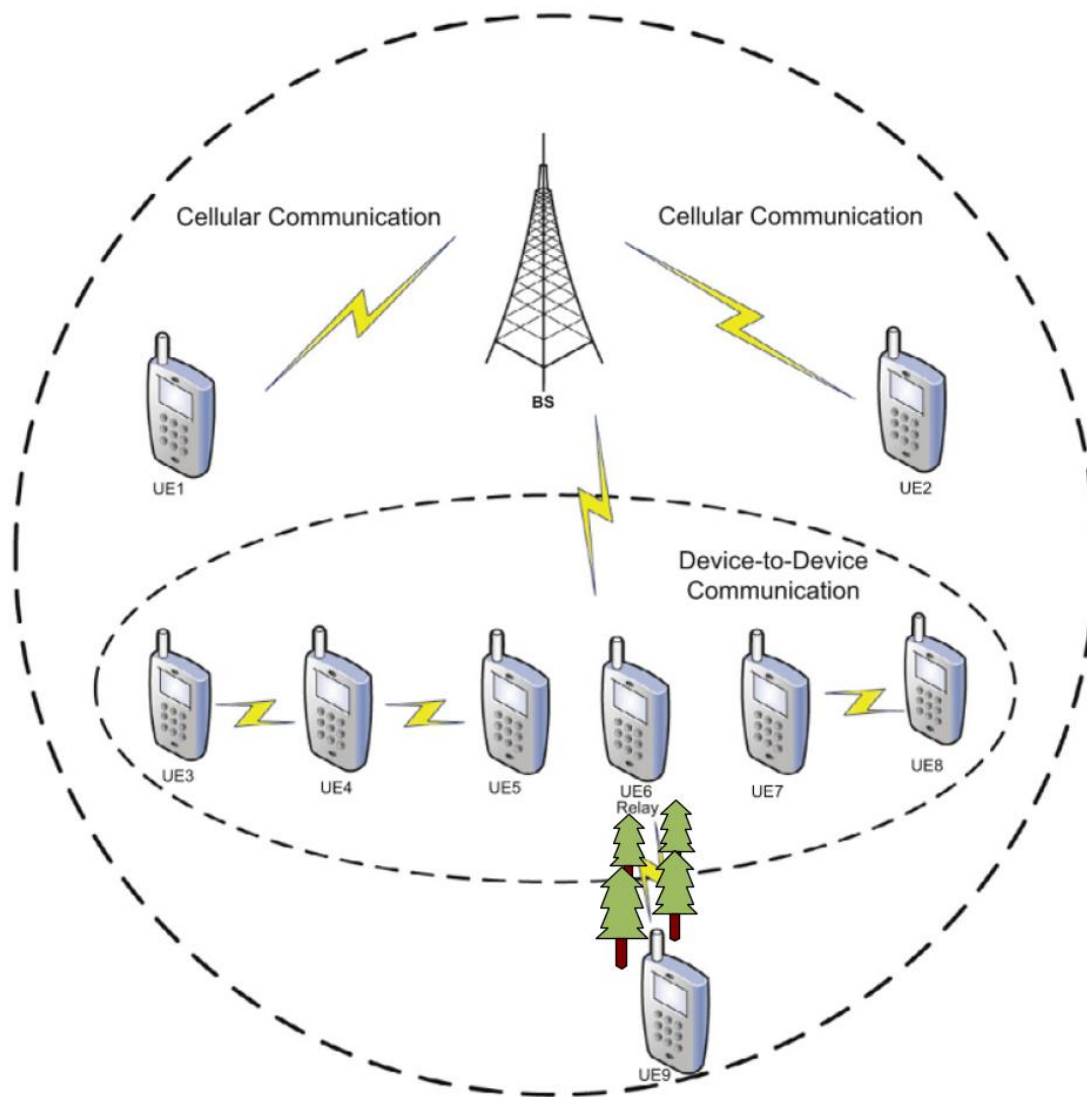

Figure 3.3 Cellular communication and D2D communication [26].

3.3. MEC with D2D relaying

Connection of the MEC and the D2D communication into one joint concept combines the advantages of each approach and results in many new opportunities for the mobile networks users.

The D2D communication in combination with the MEC [27], [28], is expected to increase 5G networks' speed, improve spectrum reuse, lower UEs' energy consumption (which is shown for an unlicensed band in [29]) and densify coverage and reduce end to end communication delay. The D2D communication can provide a way to reduce communication delay with the MEC, and also enables the UEs in the areas with poor connectivity to offload tasks to the MEC.

SIMULATION MODELS AND SCENARIOS

4. Simulation models and scenarios

The evaluation of the MEC with D2D communication and the proposed algorithm for selection of the communication path is done via Matrix Laboratory (MATLAB) language and environment. The simulations focus on the system level model, including UEs movement and multiple eNBs and SCeNBs. Thus, complex parts of the simulations are modelled via empirical models to make the simulations feasible. Main simulation parameters are shown in the Table 4.1. The simulation area is 650 x 370 meters and contains 4 eNBs, 30 SCeNBs, while the number of UEs varies between 60 and 90. To provide localities where D2D communication is beneficial, so called tree avenues with the additional path loss of 20 dB are designed in the simulation area.

Table 4.1 Main simulation parameters.

PARAMETER	VALUE
Simulation area	650 m x 370 m
Number of eNB/SCeNB	4/30
Number of UEs	60/90
Carrier frequency	2 GHz
Bandwidth for downlink/uplink	20/20 MHz
Tx power of eNB/SCeNB	27/15 dBm
Tx power of UE/UE _{D2D}	10/5 dBm
Number of sets of mutually interfering eNB/SCeNB cells	2/2
Attenuation for eNB-eNB/SCeNB-SCeNB reception due to the beam tilt	10/4 dB
Additional path loss for tree avenues	20 dB
Shadowing with log-normal distribution mean	6 dB
Handover time-to-trigger	100 ms
Handover interruption duration	30 ms
Offloading arrival rate λ	0.1/1.2/0.5/1/2 s ⁻¹
Offloaded task's input/output size	200 kB/200 kB
Offloaded task's number of instructions	1e6 instructions
Type of communication deciding coefficient K	1.1/1.3/1.5/10 ¹¹
eNB/SCeNB CPU	3300 MIPS
Speed of users	1 m/s
Simulation time/Number of simulations	3 600 s/ 10 drops
Simulation step	10 ms

In the rest of this chapter, user mobility, path loss estimation, resource allocation, user data rates computation, energy consumption model and the proposal of the algorithm for selection of the communication path are covered.

4.1. User mobility model

The simulation area is shown in the Figure 4.1 and represents a part of a city with three horizontal and four vertical stripes of buildings which are separated by streets. On each side of the street, there is a pavement for users' movement (depicted by black lines). Along each pavement, several points of interest (POIs), i.e. shops (light blue crosses), factories (magenta crosses), entertainment centres (red crosses) or flats (black crosses), can be found. The UEs are

served by eNBs (dark blue circles) and SCellNBs (green circles) with the minimal mutual distance of 65 m. The yellow stars represent entrances to the simulation area.

For the purpose of UEs movement in the simulation area, the mobility model for user movement in urban areas [30] and graph theory approach to find the shortest possible path [31] are utilised. In the mobility model, users are assigned roles which determine their movement in the simulation area, i.e. there is 30 percent of workers, 40 percent of residents, 20 percent of visitors and 10 percent of residents with dogs. Each from the workers walks from a factory to an entrance, and vice versa. When going to/from the factory, there is some probability that he or she will stop by in a shop. Furthermore, when the worker finishes the daily shift in the factory, he or she might also visit the entertainment centre. Residents stroll from entrances to their flats, and vice versa. On their way, they can drop by to supermarkets or for entertainment. Visitors come from entrances, visit one of other POIs and leave the simulation area. Residents with dogs get out of their flats, move randomly around blocks and after some time return to their flats.

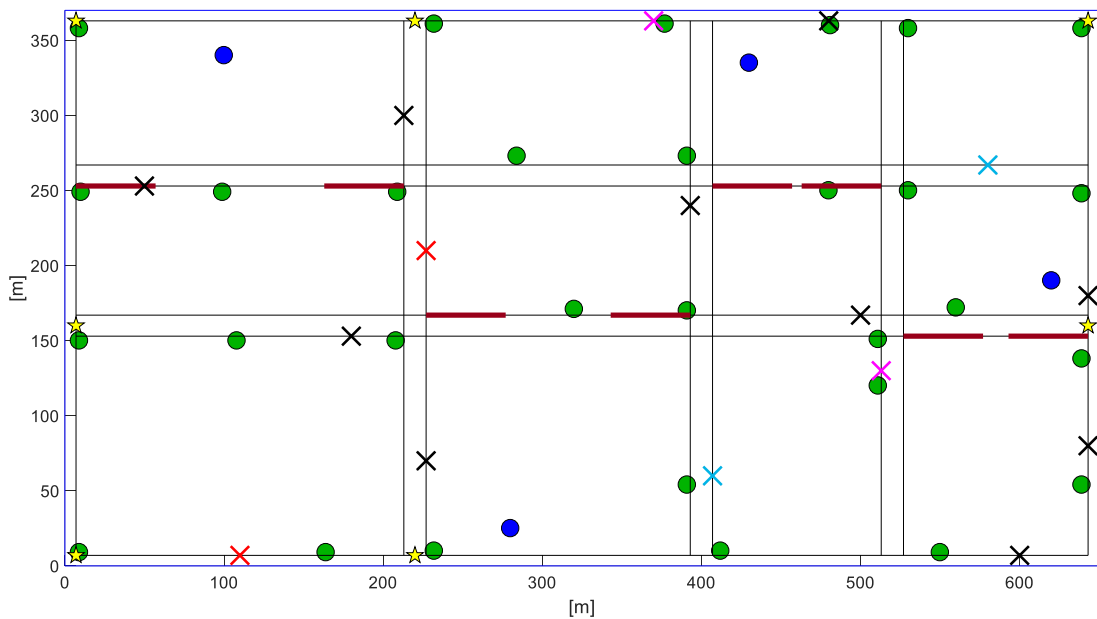

Figure 4.1 Simulation area.

4.2. Path Loss (PL) models

When a UE communicates with a BS, the difference between transmitted signal power (P_t) and received signal power depends on the communication environment, i.e. urban or rural area, shape of the streets or obstacles in the line of sight, antenna heights and the transmission power of the UE or the eNB/SCellNB. These factors define the path loss (PL) curve's shape as well as the PL models, which are used for the simulation purpose. The PL models for different types of communication, exploited in the simulations, are shown in the Table 4.2, where CASE specifies the communication elements, i.e. UE, eNB or SCellNB, then TYPE denotes the type of the

SIMULATION MODELS AND SCENARIOS

communication, and finally PATH LOSS stands for the empirical model of the PL. The simulation area represents an urban area with buildings nearly of uniform height. Therefore the model for the UE to eNB communication from [32] is used. In urban areas, UEs frequently come to the vicinity of SCeNBs. In this case, a model for the UE to SCeNB communication is selected from [33] without walls consideration, as SCeNBs are mounted on the outside of the buildings. For the purpose of the D2D communication in LOS, the maximal PL value from the formulas presented in [34] and [35] is used. When UEs do not see each other directly (NLOS), the maximal PL value from formulas introduced in [34] and [33] is used. Eventually, in areas where the pavement is followed by a tree avenue (depicted by thick dark red lines), received signal power from BSs is lowered by additional PL due to tree avenues (see the Table 4.1).

Table 4.2 Path Loss models.

CASE	TYPE	PATH LOSS (DB)
UE to eNB	Urban Macro	$PL_{dB} = 128.1 + 37.6 \log_{10} R$ R is in m
UE to SCeNB	Urban Micro, LOS	$PL_{dB} = \max(15.3 + 37.6 \log_{10} R, 38.46 + 20 \log_{10} R)$ R is in m
UE to UE	Urban Micro, LOS: D2D Relaying	$PL_{dB} = \max\left(46.4 + 20 \log_{10} R + 20 \log_{10} \frac{f}{5.0}, 40 \log_{10} R + 7.8 - 18 \log_{10} h_{UE} - 18 \log_{10} h_{UE} + 2 \log_{10} f\right)$ R is in m f is in GHz h_{UE} is the effective antenna height in m $R_{BP} < R < 5000$ m, $R_{BP} = \frac{4h_{UE}h_{UE}f \times 1000000}{c}$
UE to UE	Urban Micro, NLOS: D2D Relaying	$PL_{dB} = \max\left(46.4 + 20 \log_{10} R + 20 \log_{10} \frac{f/10^6}{5.0}, 36.7 \log_{10} R + 22.7 + 26 \log_{10} f\right)$ R is in m f is in GHz

4.3. Resource allocation

In the mobile networks, wireless communication over a range of frequencies is defined by the centre frequency and is limited on both sides by the bandwidth. The band allocation is regulated by the national regulation entity to avoid interference between the mobile operators.

In the simulation, 2 GHz carrier frequency, bandwidth (BW) of 20 MHz for uplink (from a UE to a BS) and downlink (from a BS to a UE) are selected, as shown in the Table 4.1. This means that every BS can utilise full bandwidth (resources) for the communication with the assigned UEs. All BSs divide their resources equally between all the assigned UEs which communicate in uplink or downlink, i.e. in a round robin fashion [36].

Moreover, the D2D communication exploits full duplex (i.e. relay receives and transmits data simultaneously). As a result of asymmetric uplink and downlink service loads, D2D communication is carried out in the uplink band [37]. The D2D communication is done in the uplink band and interferes with the UEs connected to other BSs.

4.4. User data rate

The data rate of the communication channel has not negligible effect on the communication delay. In this simulation, the Shannon-Hartley Capacity theorem is used. Therefore, the UE's data rate is given by the Received Signal Strength Indicator ($RSSI$), the interference from other transmitters (set I), thermal noise (NW) and the number of UEs which are assigned to the same BS and communicate (N_{UE}). Calculation of the $RSSI$ is as follows:

$$RSSI_{dBm} = Pt_{dBm} - PL_{dB}. \quad (4.1)$$

For the purpose of calculation, $RSSI$ in dBm must be converted into watts, which is done:

$$RSSI_W = \frac{10^{\frac{RSSI_{dBm}}{10}}}{1000}. \quad (4.2)$$

Signal to Interference Noise Ratio ($SINR$), which is the ratio of useful signal $RSSI_W$ (the signal from a UE or a BS) to the interference consisting from signals from other UEs or BSs $\sum_{i \in I} i_w$ and the thermal noise NW_W . $SINR$ in watts is calculated as follows:

$$SINR_W = \frac{RSSI_W}{\sum_{i \in I} i_w + NW_W}. \quad (4.3)$$

In the simulation, there are altogether four sets of BSs: two sets of eNBs and two sets of SCellNB. Only BSs from the one set interfere, i.e. set I is divided in sets I^{eNB1} , I^{eNB2} , $I^{SCellNB1}$ and $I^{SCellNB2}$. This is to limit the interference between the BSs, by exploiting different carrier frequency in each set. Knowing the $SINR$ and the N_{UE} , the data rate is calculated as follows:

$$C_{bps} = \frac{BW_{Hz}}{N_{UE}} \log_2(1 + SINR_W). \quad (4.4)$$

SIMULATION MODELS AND SCENARIOS

The resource allocation procedure is shown in the diagram in the Figure 4.2.

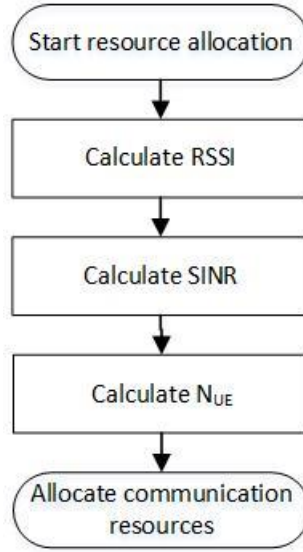

Figure 4.2 Resource allocation procedure.

4.5. Energy consumption model

The energy consumption model for the UEs is based on an empirical model defined in [38]. In the model, authors specify the power consumption of the UE being turned on as $P_{ON} = 853 \text{ mW}$, uplink communication power P_{UL} and downlink communication power P_{DL} . Both, the uplink and downlink power consumption are comprised of the signal processing parts P_{TxBB} and P_{RxBB} , radio parts P_{TxRF} and P_{RxRF} and circuitry of communication parts P_{TxON} and P_{RxON} . Power consumed in uplink and downlink communications are calculated as follows, respectively:

$$\begin{aligned} P_{UL} &= P_{TxON} + P_{TxRF} + P_{TxBB} \text{ [mW]}, \\ P_{DL} &= P_{RxON} + P_{RxRF} + P_{RxBB} \text{ [mW]}. \end{aligned} \quad (4.5)$$

Further, $P_{TxON} = 29.9 \text{ mW}$, $P_{TxBB} = 0.62$, $P_{RxON} = 25.1 \text{ mW}$ and $P_{RxBB} = 0.97R_{Rx} + 8.16 \text{ [mW]}$, where R_{Rx} is the downlink data rate in Mbit/s. P_{TxRF} is calculated as:

$$P_{TxRF} = \begin{cases} 0.78S_{Tx} + 23.6 & S_{Tx} \leq 0.2 \\ 17S_{Tx} + 45.4 & 0.2 \leq S_{Tx} < 11.4, \\ 5.9S_{Tx}^2 - 118S_{Tx} + 1195 & 11.4 < S_{Tx} \end{cases} \quad (4.6)$$

where S_{Tx} is the transmission power of the UE in dBm. P_{RxRF} is calculated as:

$$P_{TxRF} = \begin{cases} -0.04S_{Rx} + 24.8 & S_{Rx} \leq -52.5 \\ -0.11S_{Rx} + 7.86 & S_{Rx} \geq -52.5 \end{cases} \quad (4.7)$$

where S_{Rx} is the power received at the UE from the BS in dBm.

The energy consumption in uplink and downlink are then calculated by multiplying required power by transmission time:

$$\begin{aligned} E_{UL} &= P_{ON}t^{transmit} + P_{UL}t^{transmit} \text{ [J]}, \\ E_{DL} &= P_{ON}t^{receive} + P_{UL}t^{receive} \text{ [J]}. \end{aligned} \quad (4.8)$$

When energy consumption of D2D communication is calculated, the relay consumes energy in both, downlink as well as uplink, since full duplex communication is considered.

4.6. Algorithm for selection of the communication path

In this section, an algorithm for the selection of the communication path is proposed. The algorithm exploits D2D communication when it is beneficial with respect to offloading delay in the MEC.

When the UE (source) wants to offload the task, neighbouring UEs $r \in R$, where R is a set of UEs in proximity served by the same BS as the BS which serves the source UE. The decision on a communication path is done in the MEC orchestrator, which collects network information about the UEs. The orchestrator decides according to the proposed algorithm, as shown in the Figure 4.3. The algorithm selects D2D communication if the data rate via D2D relaying $\min(c_r^{relay}, c_r^{relay,MEC})$, consisting of D2D communication between the source UE and the relay r (c_r^{relay}) and between the relay r and the MEC server ($c_r^{relay,MEC}$), is higher than the direct communication of the source c^{source} multiplied by the coefficient K . Therefore, following must hold:

$$\begin{aligned} c^{source} \times K &< c_r^{relay}, \\ c^{source} \times K &< c_r^{relay,MEC}. \end{aligned} \quad (4.9)$$

According to the defined simulation model, users exploiting MEC move with respect to their role in the simulation. During their movement, they are assigned to the serving BSs based on the $SINR$, i.e. UE is served by the BS which provides the highest $SINR$. When a different BS surpasses the $SINR$ of the serving BS, so called target BS, the UE stays connected to the serving BS for an extra period of time (i.e. time-to-trigger, see the Table 4.1). If the $SINR$ of the target BS is better than $SINR$ of the serving BS for the whole time-to-trigger, handover, utilised to change the connection from one BS to another, is executed. Then, the target BS becomes the serving BS. Otherwise, the serving BS is not substituted. When it is decided to perform the handover, the UE cannot exchange its packets with the BS during the handover interruption time (see the Table 4.1) and all the offloaded task which are currently exploiting affected UE are terminated and offloading must start over again. The offloaded tasks, which were not appropriately received, i.e. offloading was interrupted, are called unsuccessful offloaded tasks.

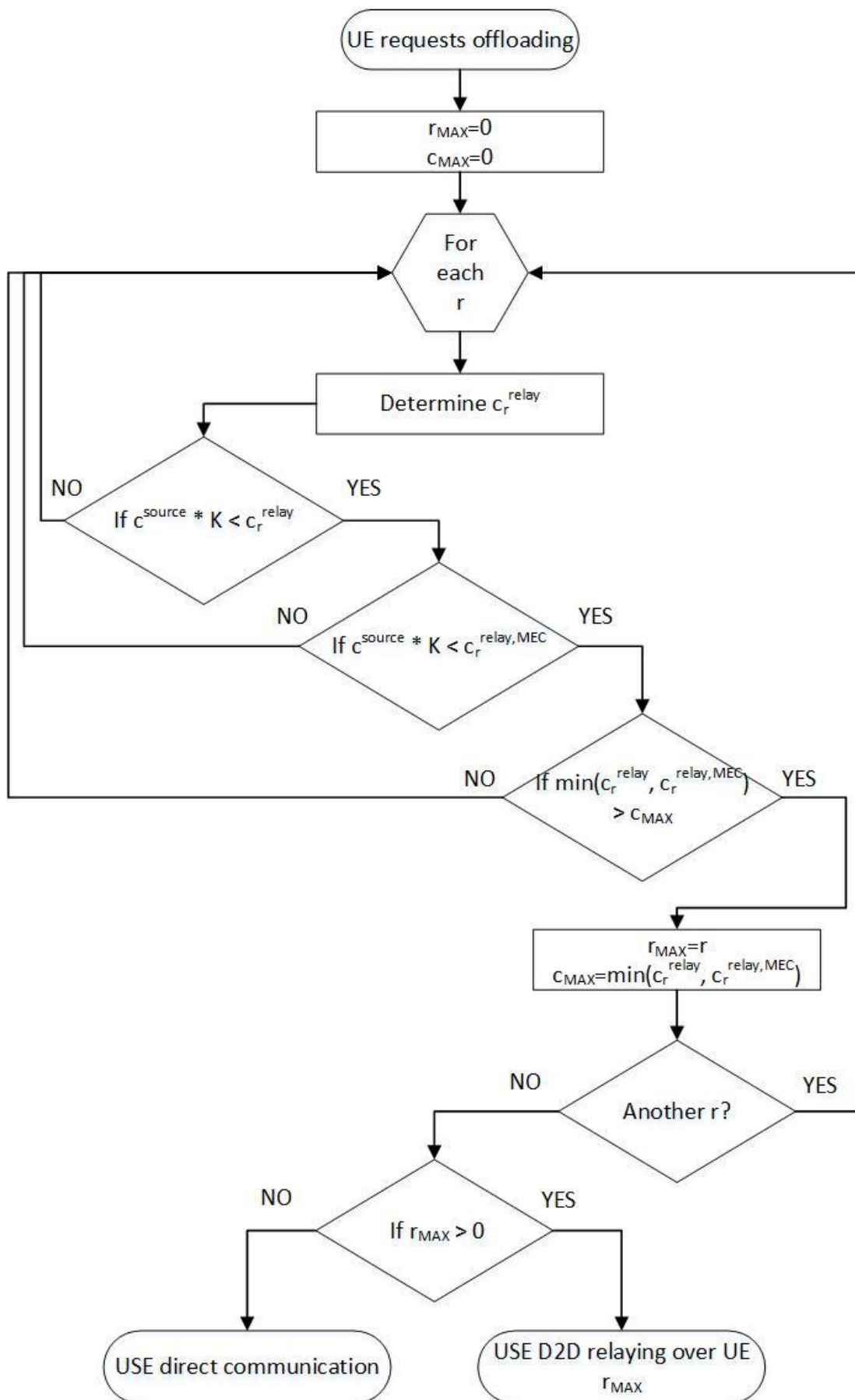

Figure 4.3 Algorithm for selection of the communication path.

SIMULATION MODELS AND SCENARIOS

Performance of the proposed algorithm for selection of the communication path is examined on the simulation model using simulation scenarios with various parameters, i.e. number of UEs, offloading arrival rate λ and coefficient K .

SIMULATION RESULTS

5. Simulation results

In this chapter, simulation results with a performance evaluation are provided. The main goal of this performance evaluation via simulations is to show, that the exploitation of D2D communication according to the proposed algorithm reduces offloading delay. Furthermore, the proposed algorithm is examined in different simulation scenarios, so results for 60 and 90 UEs, offloading arrival rate between 0.1 and 2 s⁻¹, and communication decision coefficient (K) with values of 1.1, 1.3 and 1.5, are presented. To provide a comparison with the communication without D2D communication, in this case, K is set to large enough value (10^{11}) to avoid D2D communication. In the rest of this chapter, different simulation characteristics, such as offloading delay, a ratio of the offloaded tasks exploiting D2D communication and eventually, energy consumption for the task offloading, are inspected.

5.1. Offloading delay

First, performance evaluation in terms of offloading delay is presented. The Figure 5.1 shows the offloading delay in uplink and downlink, respectively. It can be seen that offloading delay grows with increased offloading arrival rate. This is caused by increasing network load and gradual exploitation of all available resources by the offloaded tasks from the UEs. Significant improvement of the offloading delay is observed when the UEs exploit D2D communication. This trend is due to avoidance of the channels with a lower data rate. The gain of the D2D is up to 22 % (6.1 ms) for 60 UEs and 26 % (7.4 ms) for 90 UEs for all K values in uplink and up to 27 % (5.1 ms) for 60 UEs and 27 % (5.4 ms) for 90 UEs for all K values in downlink. In both uplink and downlink, the gain of the D2D communication decreases with increased offloading arrival rate, as shown in the Figure 5.1. The decrease in the gain is caused by the UEs communicating more often, i.e. offloading more frequently, and leaving fewer communication resources to be exploited by the D2D. Note that the offloading arrival rate is the same for all the UEs in the simulation, but in the real deployment, the offloading arrival rate of each UE varies, leaving resources for the D2D communication. Since D2D communication is carried out in the uplink, the mean offloading delay for offloading is up to twice as high as collecting of the processed results from the MEC in the downlink (see the Figure 5.1). This is caused by the uplink being generally of lower communication quality due to the lower transmission power of the UE in comparison to the eNB/SCeNB, and the fact that the D2D communication is carried out in the uplink.

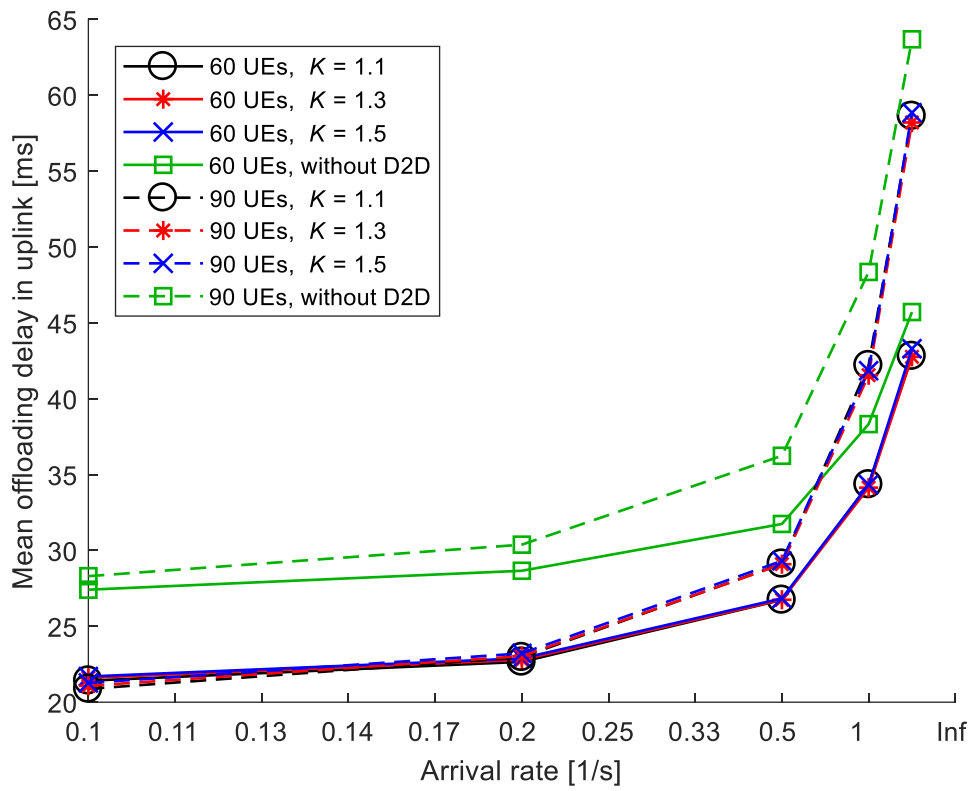

a)

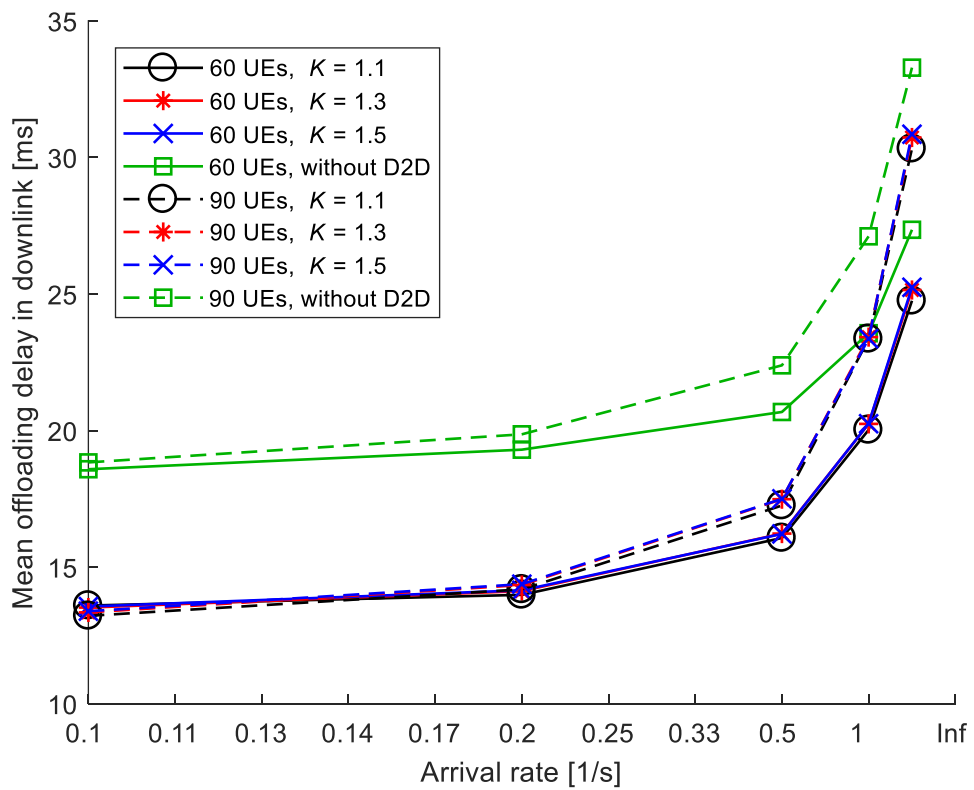

b)

Figure 5.1 Mean offloading delay per UE a) in uplink and b) in downlink.

SIMULATION RESULTS

5.2. Number of offloaded tasks

This section shows the total number of offloaded tasks per UE for various simulation scenarios. As shown in the Figure 5.2, the total number of offloaded tasks per a UE is increasing with increasing offloading arrival rate, independently on the number of the UEs or exploitation of the algorithm for communication path selection. Thus, the communication load of the network increases in the same manner. This is the reason why the gain of the D2D communication in the Figure 5.1 decreases, as it is due to a gradual lowering of the number of the available communication resources.

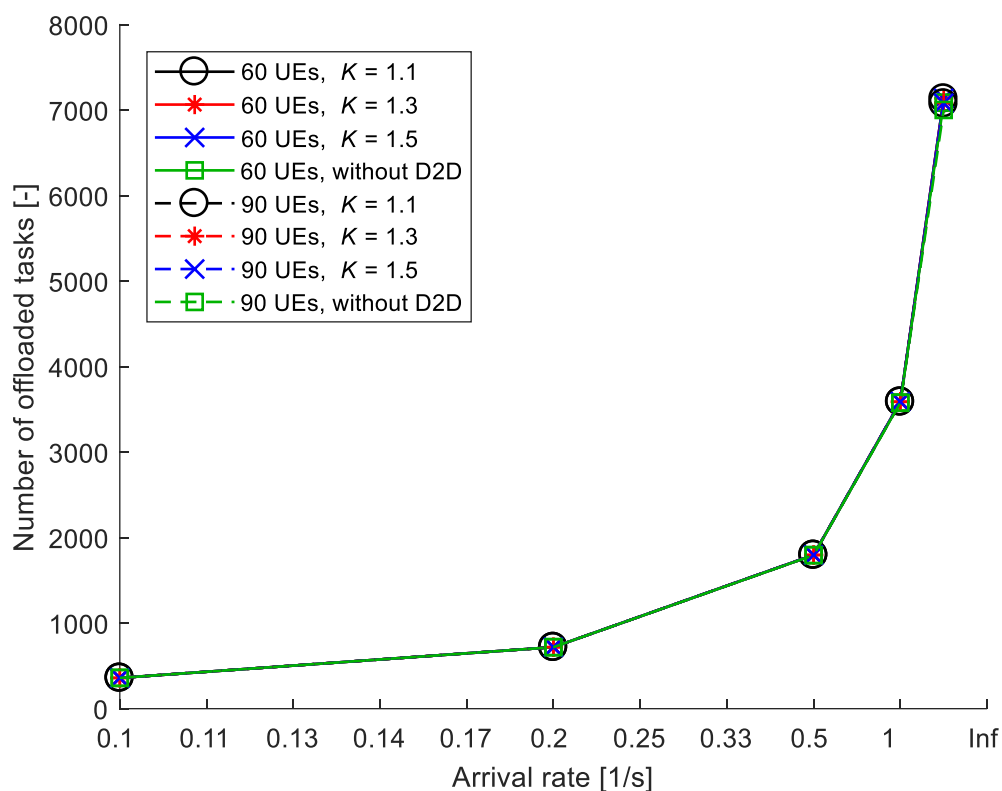

Figure 5.2 Number of offloaded tasks per UE.

5.3. The ratio of tasks offloaded with D2D relaying

The ratio of tasks offloaded with D2D relaying to all offloaded tasks is shown in the Figure 5.3. The ratio indicates how often is D2D communication used relative to all offloaded tasks. In the Figure 5.3, the ratio of the offloaded tasks exploiting D2D communication contains offloaded tasks, where the D2D communication is exploited either in uplink or downlink. All the ratios are constant for offloading arrival rates lower than 1 s^{-1} , when λ is higher, the ratio of tasks offloaded with D2D relaying descends. The decrease is caused by the communication resources being overloaded (see the Figure 5.2), leading to a lower number of communication resources to be exploited by the D2D communication. The smaller the coefficient K is, the more D2D communication is exploited for the offloading, i.e. less strict requirements on the D2D

communication are applied. Furthermore, as more UEs are placed into the simulation area, more opportunities to exploit the D2D communication are available. This is caused by more dense deployment of the UEs and leads to a higher probability of a UE being in proximity of another UE.

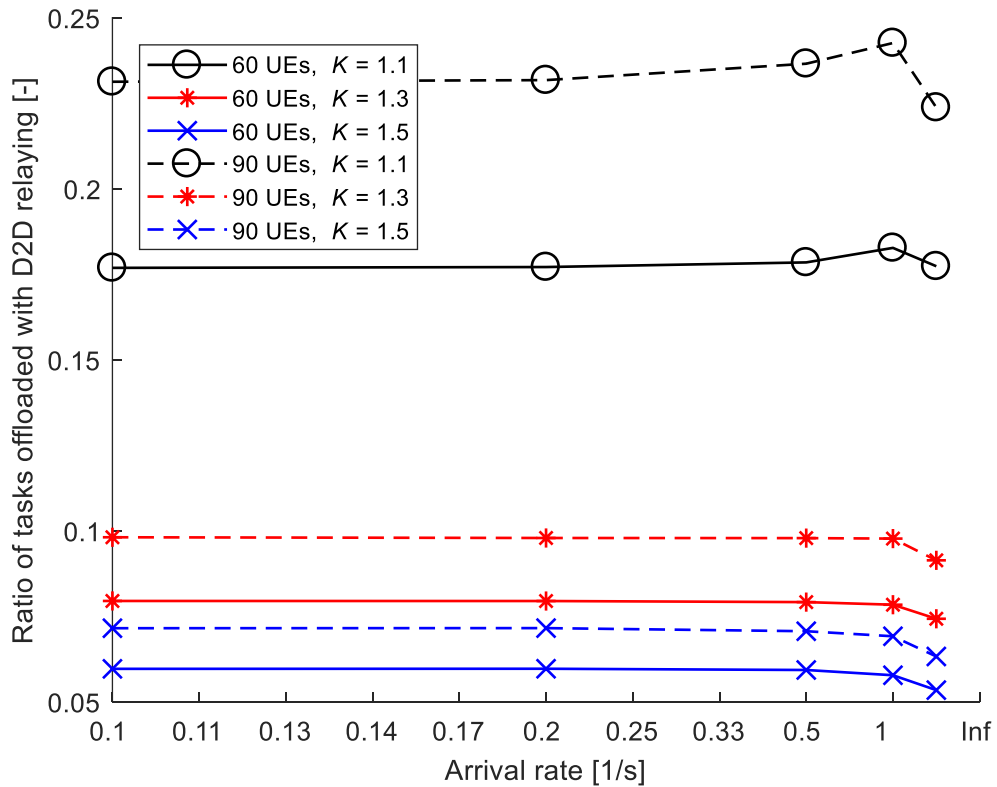

Figure 5.3 Ratio of tasks offloaded with D2D relaying.

In addition to the Figure 5.3, the ratio of the unsuccessful offloaded tasks with D2D relaying to all offloaded tasks is shown in the Figure 5.4. Until the offloading arrival rate reaches 0.5 s^{-1} , the ratios for different number of UEs and different K are slightly growing. Then, two different trends based on the density of UEs can be observed. For 60 UEs, the ratio of unsuccessful offloaded tasks starts to decrease, as UEs are more distant and thus, UEs pursue to exploit D2D communication less often. Therefore, fewer D2D relayed tasks fail to be offloaded. However, when 90 UEs are deployed, the ratio of unsuccessful offloaded tasks remains constant or even, for small K , grows. This is the consequence of having more UEs in proximity and more opportunities to exploit other UEs. For 90 UEs and K of 1.1, utilising D2D communication becomes more burdening, as it results in a significant decrease of offloaded tasks and a remarkable increase of unsuccessful offloaded tasks, compared to other simulation scenarios, as can be seen in the Figure 5.3 and Figure 5.4.

SIMULATION RESULTS

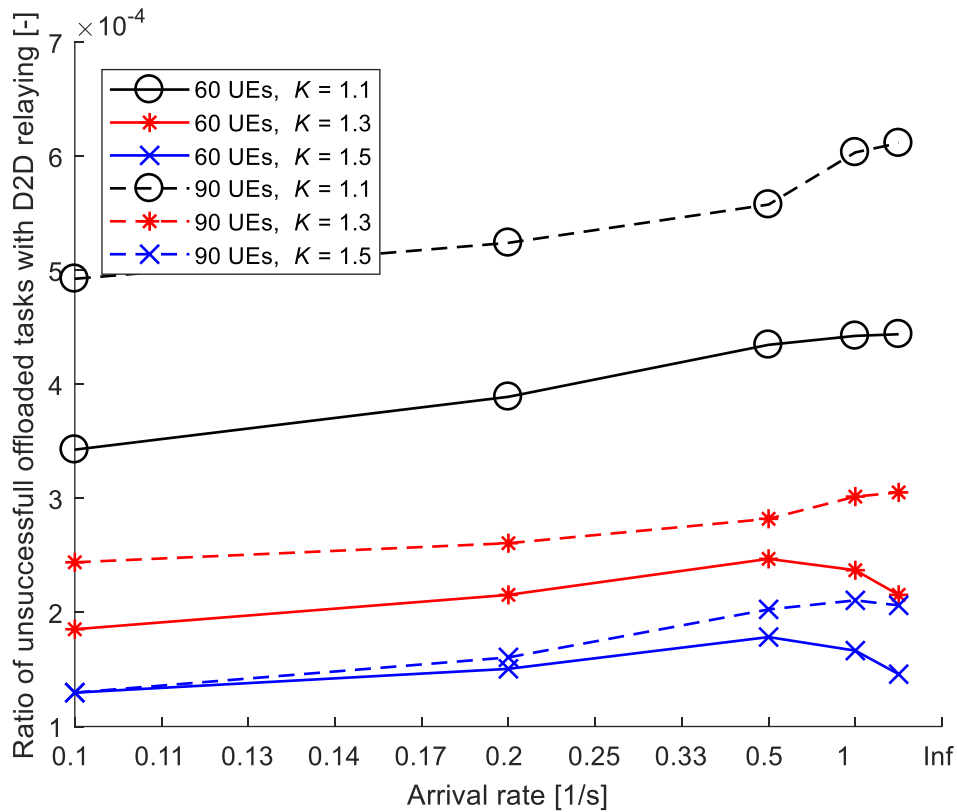

Figure 5.4 Ratio of unsuccessful tasks offloaded with D2D relaying.

5.4. Number of unsuccessful offloaded tasks with D2D relaying

In this part, the impact of various simulation parameters on the number of unsuccessful offloaded tasks exploiting D2D communication is presented. In the Figure 5.5, the number of unsuccessful offloaded tasks grows with higher offloading arrival rate. It can be seen, that increasing the UEs deployment enlarges the total number of unsuccessful offloaded tasks, due to the higher number of offloaded tasks exploiting D2D communication, i.e. more opportunities for the D2D communication. Furthermore, when the coefficient K , enabling D2D communication, is low, the number of unsuccessful offloaded tasks is increasing.

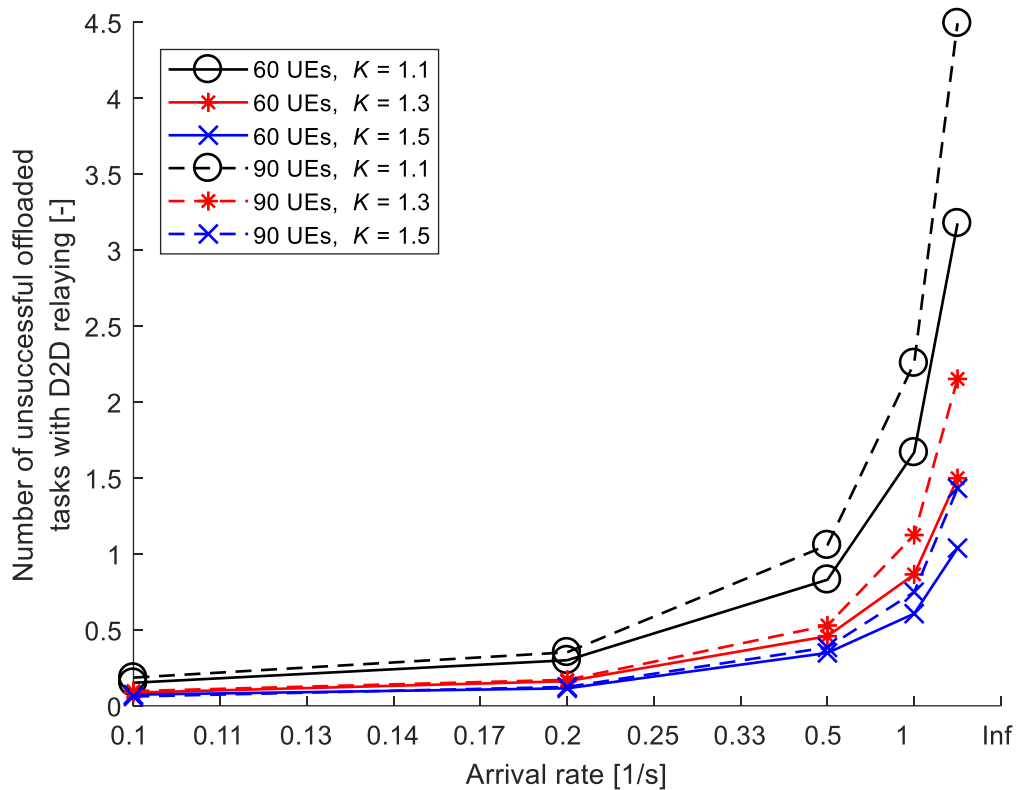

Figure 5.5 Number of unsuccessful offloaded tasks with D2D relaying per UE.

5.5. Energy Consumption

In this last section, the energy consumption per task offloading is presented. In the Figure 5.6, the mean energy consumption per the task offloading is shown for 60 UEs. The energy consumption is divided in uplink (transmit) and downlink (receive) communication. It can be seen, that energy consumption grows with increased offloading arrival rate. The enlarged energy consumption is due to the increased mean offloading delay as shown in the Figure 5.1. The higher energy consumption of transmission than the reception is due to more energy is being required for transmission than reception. The D2D communication reduces energy consumption when K is higher than 1.1 in comparison to communication without the D2D communication. The lower energy consumption is due to lower offloading delay and lower transmission power of the UEs, required for the D2D communication. The D2D relaying decreases the energy consumption by up to 13 % (4.0 mJ) for transmission and by up to 11 % (2.2 mJ) for the reception of the offloaded task and K equal to 1.5

SIMULATION RESULTS

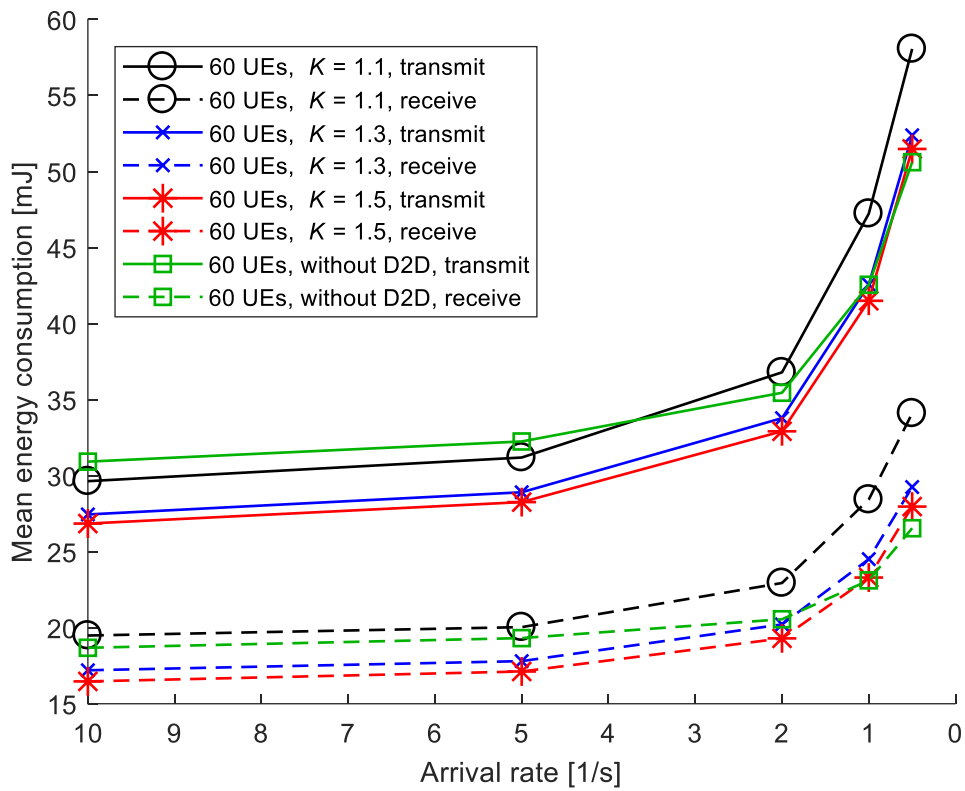

Figure 5.6 Mean energy consumption per task offloading with 60 UEs.

In the Figure 5.7 the energy consumption for 90 UEs is shown. The results are similar to the case with 60 UEs (see the Figure 5.6). The D2D relaying decreases the energy consumption by up to 17 % (5.4 mJ) for transmission and by up to 12 % (2.4 mJ) for the reception of the offloaded task and K equal to 1.5.

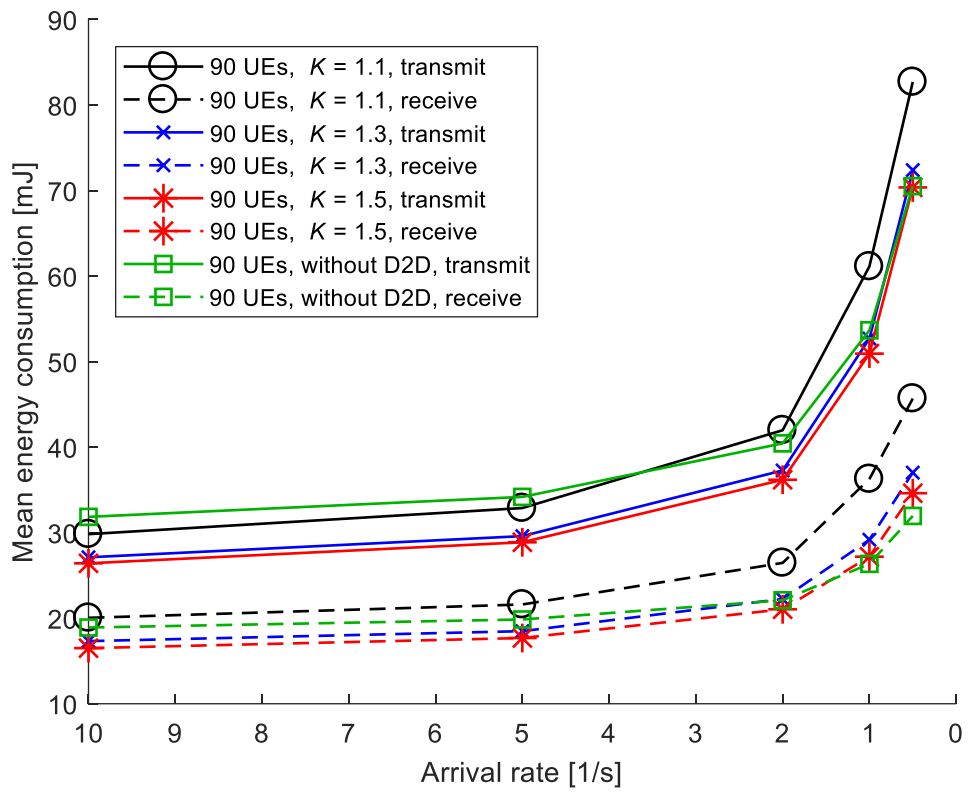

Figure 5.7 Mean energy consumption per task offloading with 90 UEs.

CONCLUSION

6. Conclusion

The main goal of this thesis is to design an algorithm for the selection of the communication path exploiting D2D communication with the MEC and to do a performance evaluation.

The proposed algorithm for selection of communication path with D2D communication exploits D2D communication if the data rate via D2D relaying is higher than communication without D2D multiplied by a decision coefficient to avoid exploiting D2D relaying when it is only slightly better than direct communication. It is shown that the proposed algorithm outperforms communication without D2D communication in terms of offloading delay and energy consumed by the UE. The D2D communication occurs in the UE's uplink communication channel resources, by re-using them to improve the efficiency of resource usage. This leads to lower offloading delay in both, uplink, where the offloaded task is transmitted from the UE to the MEC, and downlink, where the UE receives processed offloaded task from the MEC. The results show, that D2D communication is beneficial for offloaded tasks independently on the offloaded task's arrival rate.

The D2D communication can also lead to lower energy consumption, by exploiting the D2D communication when the communication data rate with the D2D communication is much higher than communication without D2D. This is in the proposed algorithm achieved via decision coefficient K . Thus, the mobile operator or even the UE can choose when to exploit D2D communication. The relay, i.e. UE which is exploited to relay data from the source UE to the MEC should be motivated to do so. The motivation can be done in multiple ways, e.g. as the relaying UE can exploit another UE in the future for relaying, it can be allocated more communication resources for its traffic or can be given some benefits from the mobile operator, as it effectively improves communication efficiency and mobile network coverage.

From the point of unsuccessfully completed tasks, the D2D communication leads to only negligible number of unsuccessful tasks, due to the exploitation of the D2D communication only when it is beneficial to the UE. It should be noted that the proposed algorithm is not limited to mobile users, but can be exploited, for example, in vehicular computing, where vehicles can provide relaying to other vehicles.

In the future, this work can be extended by exploiting the MEC not only for offloading tasks, but also for network optimization. The optimization can be done by employing the prediction of user mobility and channel quality to predict the gain of the D2D communication. Furthermore, power control of the D2D communication can lower the energy consumption of the UE exploiting the MEC by lowering the UE's transmission power.

7. References

- [1] Ericsson, "Ericsson Mobility Report Q4 Update February 2019," no. 2, p. 4, 2018.
- [2] M. Carugi, "Key features and requirements of 5G/IMT-2020 networks," 2018.
- [3] "ITU's approach to 5G." [Online]. Available: <https://news.itu.int/5g-fifth-generation-mobile-technologies/>. [Accessed: 04-Apr-2019].
- [4] "ETSI - Multi-access Edge Computing." [Online]. Available: <https://www.etsi.org/technologies/multi-access-edge-computing>. [Accessed: 16-May-2019].
- [5] T. Taleb, K. Samdanis, B. Mada, H. F. S. & Tutorials, and undefined 2017, "On multi-access edge computing: A survey of the emerging 5G network edge cloud architecture and orchestration," *IEEE Explore.Ieee.Org*, vol. 19, no. 3, pp. 1657–1681, 2017.
- [6] C. Hoymann, W. Chen, J. Montojo, A. Golitschek, C. Koutsimanis, and X. Shen, "Relaying operation in 3GPP LTE: Challenges and solutions," *IEEE Commun. Mag.*, vol. 50, no. 2, pp. 156–162, 2012.
- [7] "SA1 completes its study into 5G requirements." [Online]. Available: https://www.3gpp.org/news-events/1786-5g_reqs_sa1. [Accessed: 19-May-2019].
- [8] "What is enhanced Mobile Broadband (eMBB)." [Online]. Available: <https://5g.co.uk/guides/what-is-enhanced-mobile-broadband-emb/>. [Accessed: 19-May-2019].
- [9] X. Chen, L. Jiao, W. Li, and X. Fu, "Efficient Multi-User Computation Offloading for Mobile-Edge Cloud Computing," *IEEE/ACM Trans. Netw.*, vol. 24, no. 5, pp. 2795–2808, Oct. 2016.
- [10] H. T. Dinh, C. Lee, D. Niyato, and P. Wang, "A survey of mobile cloud computing: architecture, applications, and approaches," *Wirel. Commun. Mob. Comput.*, vol. 13, no. 18, pp. 1587–1611, Dec. 2013.
- [11] S. S. Qureshi, T. Ahmad, K. Rafique, and Shuja-ul-islam, "Mobile cloud computing as future for mobile applications - Implementation methods and challenging issues," in *2011 IEEE International Conference on Cloud Computing and Intelligence Systems*, 2011, pp. 467–471.
- [12] M. V. Barbera, S. Kosta, A. Mei, and J. Stefa, "To offload or not to offload? the bandwidth and energy costs of mobile cloud computing," *Proc. - IEEE INFOCOM*, pp. 1285–1293, 2013.
- [13] D. Yao, C. Yu, L. Yang, and H. Jin, "Using Crowdsourcing to Provide QoS for Mobile Cloud Computing," *IEEE Trans. Cloud Comput.*, no. December, pp. 1–1, 2015.

REFERENCES

- [14] A. Bezeichnung, "Mobile-Edge Computing – Introductory Technical White Paper," *ETSI White Pap.*, no. 1, pp. 1–8, 2014.
- [15] Y. Mao, C. You, J. Zhang, K. Huang, and K. B. Letaief, "A Survey on Mobile Edge Computing: The Communication Perspective," pp. 1–37, 2017.
- [16] K. Zhang *et al.*, "Energy-Efficient Offloading for Mobile Edge Computing in 5G Heterogeneous Networks," *IEEE Access*, vol. 4, pp. 5896–5907, 2016.
- [17] R. Architecture, "Etsi gs mec 003," vol. 1, pp. 1–21, 2019.
- [18] J. Oueis, E. C. Strinati, and S. Barbarossa, "Multi-parameter decision algorithm for mobile computation offloading," *IEEE Wirel. Commun. Netw. Conf. WCNC*, vol. 3, pp. 3005–3010, 2014.
- [19] J. Plachy, Z. Becvar, and P. Mach, "Path selection enabling user mobility and efficient distribution of data for computation at the edge of mobile network," *Comput. Networks*, vol. 108, pp. 357–370, 2016.
- [20] N. Wang and J. Wu, "Opportunistic WiFi offloading in a vehicular environment: Waiting or downloading now?," in *IEEE INFOCOM 2016 - The 35th Annual IEEE International Conference on Computer Communications*, 2016, pp. 1–9.
- [21] Wi-Fi Alliance, "Wi-Fi Peer-to-Peer (P2P) Technical Specification," *Specifications*, vol. 1.7, p. 201, 2016.
- [22] Bluetooth Special Interest Group, "Bluetooth Core Specification Version 5.0," *Bluetooth Core Specif. Version 5.0*, no. December, p. 2684, 2016.
- [23] M. Noura and R. Nordin, "A survey on interference management for Device-to-Device (D2D) communication and its challenges in 5G networks," *J. Netw. Comput. Appl.*, vol. 71, pp. 130–150, 2016.
- [24] M. Tehrani, M. Uysal, and H. Yanikomeroglu, "Device-to-device communication in 5G cellular networks: Challenges, solutions, and future directions," *IEEE Commun. Mag.*, vol. 52, no. 5, pp. 86–92, 2014.
- [25] I. C. Surveys, "In-Band Device-to-Device Communication in OFDMA Cellular Networks : A Survey and In-Band Device-to-Device Communication in OFDMA Cellular Networks : A Survey and Challenges," vol. 17, no. November, pp. 1885–1922, 2015.
- [26] U. N. Kar and D. K. Sanyal, "An overview of device-to-device communication in cellular networks," *ICT Express*, vol. 4, no. 4, pp. 203–208, Dec. 2018.
- [27] X. Chen, L. Pu, L. Gao, W. Wu, and D. Wu, "Exploiting Massive D2D Collaboration for Energy-Efficient Mobile Edge Computing," *IEEE Wirel. Commun.*, vol. 24, no. 4, pp. 64–71, 2017.

- [28] N. D. D. Collaboration, "D2D Fogging : An Energy-Efficient and Incentive-Aware Task Offloading Framework," *IEEE J. Sel. Areas Commun.*, vol. 34, no. 12, pp. 3887–3901, 2016.
- [29] B. Shi, J. Yang, Z. Huang, and P. Hui, "Offloading Guidelines for Augmented Reality Applications on Wearable Devices," *Proc. 23rd ACM Int. Conf. Multimed.*, pp. 1271–1274, 2015.
- [30] Z. Becvar, M. Vondra, and P. Mach, "Dynamic Optimization of Neighbor Cell List for Femtocells," in *2013 IEEE 77th Vehicular Technology Conference (VTC Spring)*, 2013, pp. 1–6.
- [31] J.-C. Fournier, *Graph theory and applications with exercises and problems*. ISTE, 2009.
- [32] TSGR, "TR 136 931 - V9.0.0 - LTE; Evolved Universal Terrestrial Radio Access (E-UTRA); Radio Frequency (RF) requirements for LTE Pico Node B (3GPP TR 36.931 version 9.0.0 Release 9)," vol. 0, pp. 0–28, 2011.
- [33] T. Specification, G. Radio, A. Network, and P. L. Aspects, "3gpp tr 36.814," vol. 1, no. Release 9, pp. 1–31, 2009.
- [34] P. Kyösti *et al.*, "IST-4-027756 WINNER II, WINNER II Channel Models," *Part I Channel Model.*, vol. 1.2, no. June 2014, pp. 1–82, 2008.
- [35] I. Conference and D. Hutchison, *Analytical and Stochastic Modelling Techniques and Applications*, vol. 9081, no. July. 2015.
- [36] R. V. Rasmussen and M. A. Trick, "Round robin scheduling – a survey," *Eur. J. Oper. Res.*, vol. 188, no. 3, pp. 617–636, Aug. 2008.
- [37] Jiaheng Wang, Daohua Zhu, Chunming Zhao, J. C. F. Li, and Ming Lei, "Resource Sharing of Underlying Device-to-Device and Uplink Cellular Communications," *IEEE Commun. Lett.*, vol. 17, no. 6, pp. 1148–1151, Jun. 2013.
- [38] M. Lauridsen, Noël, Laurent, T. B. Sørensen, and P. Mogensen, "An Empirical LTE Smartphone Power Model with a View to Energy Efficiency Evolution," *Intel Technol. J.*, vol. 18, no. 1, pp. 172–193, 2014.