

C

SO 101

ČVUT ČESKÉ VYSOKÉ UČENÍ TECHNICKÉ V PRAZE			FAKULTA STAVEBNÍ KATEDRA SILNIČNÍCH STAVEB Thákurova 7/2077 166 29 Praha 6 Dejvice
NÁZEV DIPLOMOVÉ PRÁCE: Rekonstrukce silnice II/304 Bohuslavice - Opočno			VEDOUcí DIPLOMOVÉ PRÁCE: Ing. Petr Pánek, Ph.D. katedra silničních staveb Fakulta stavební
SO 101	Komunikace a zpevněné plochy		VYPRACOVAL: Bc. Aneta Škorpilová 
ČÍSLO PŘÍLOHY: 05	NÁZEV PŘÍLOHY: Příčné řezy	FORMÁT: 50xA4 MĚŘÍTKO: 1:200	DATUM: 01/2019

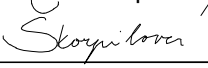

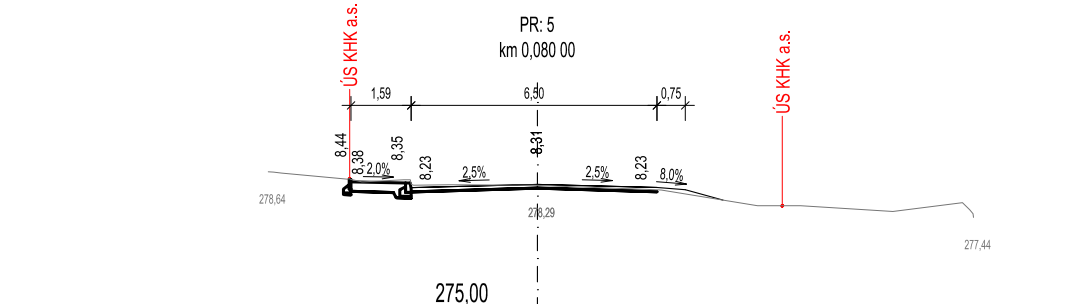
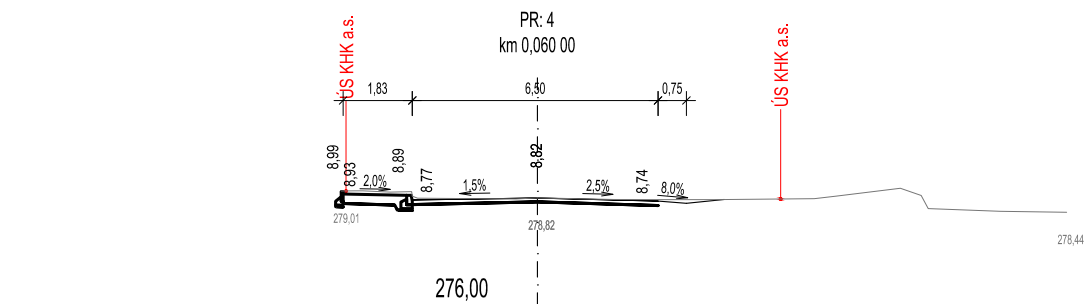
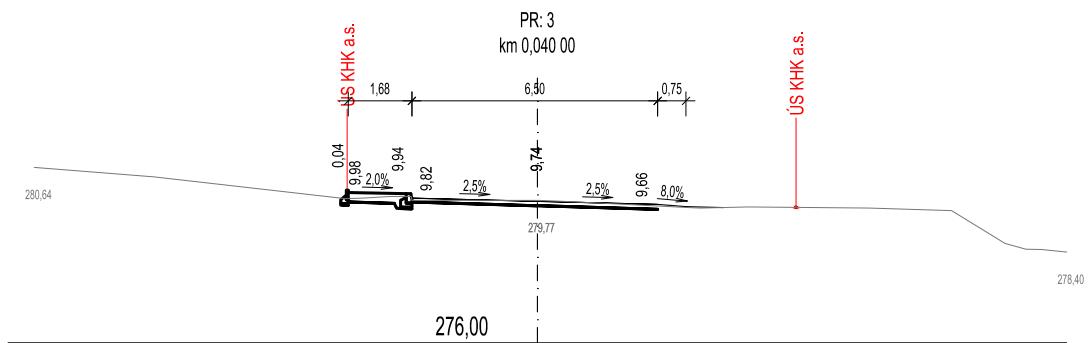
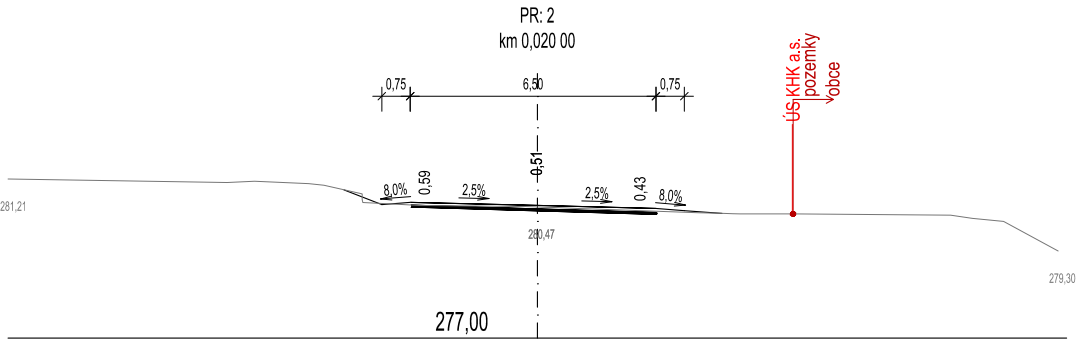
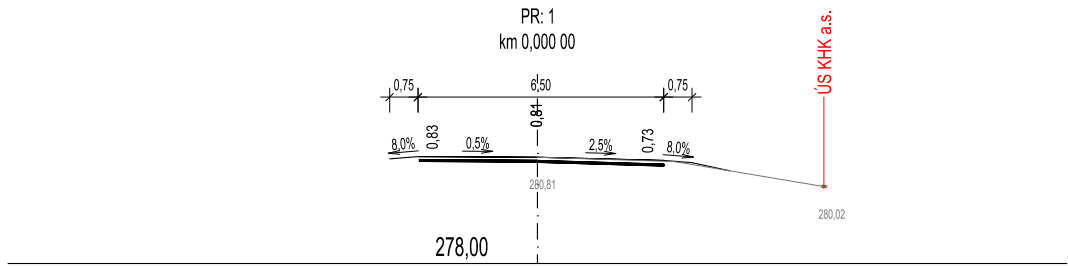
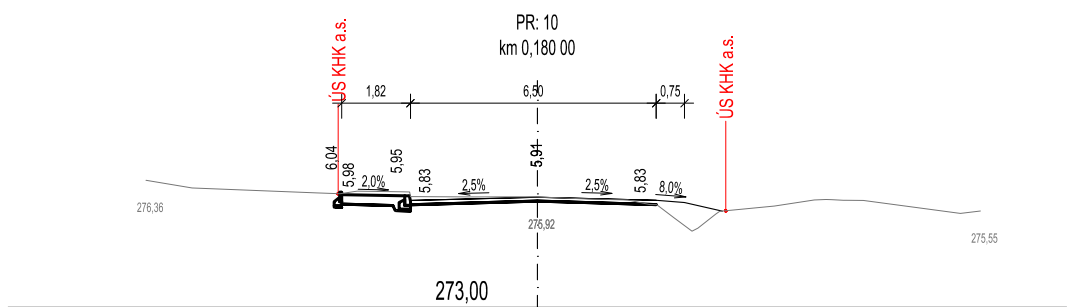
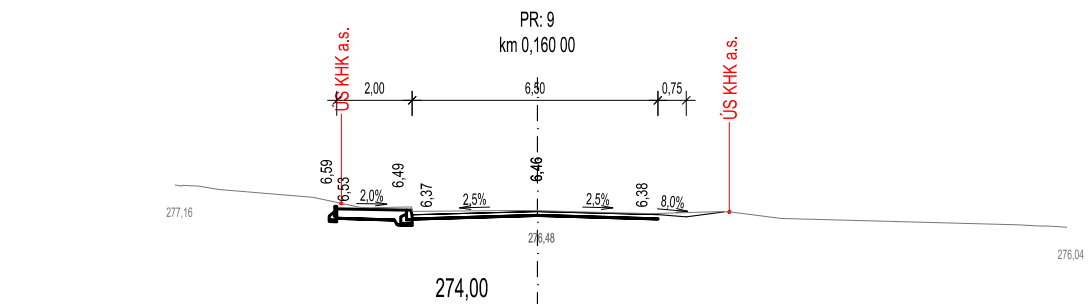
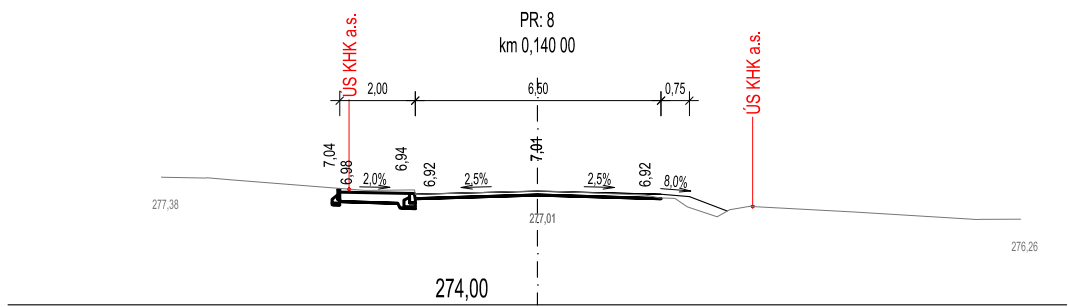
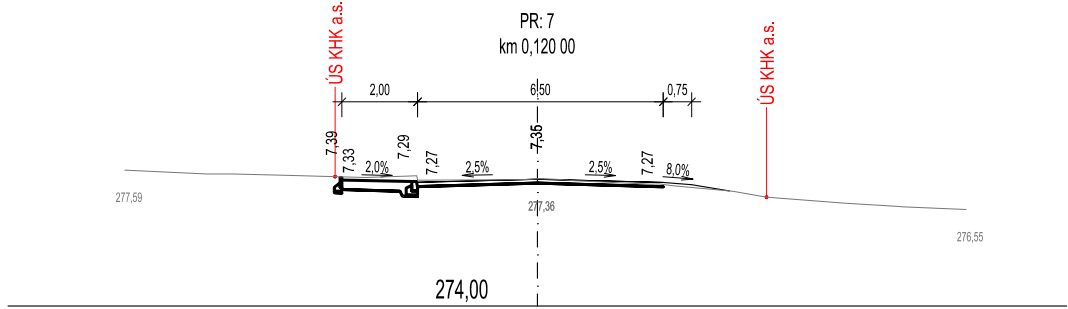
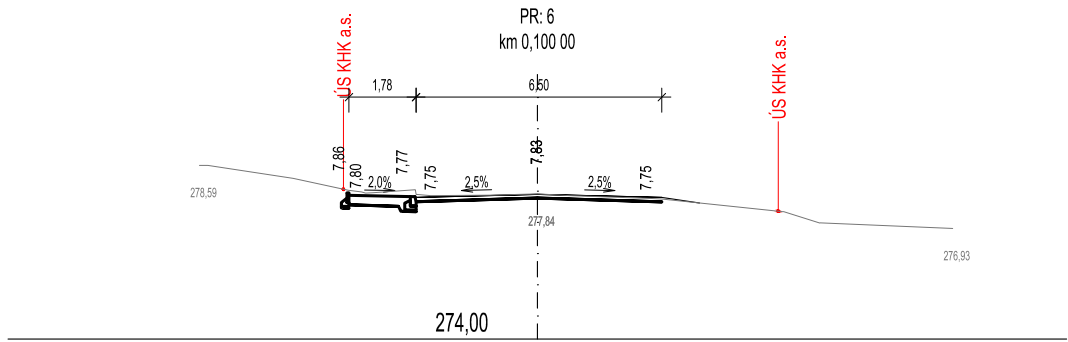

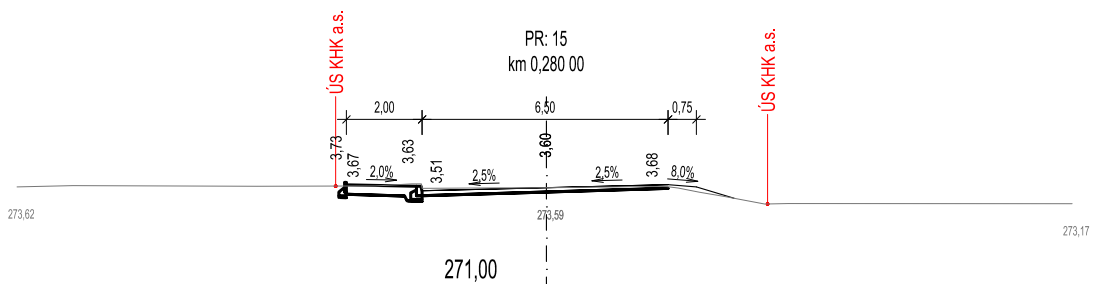
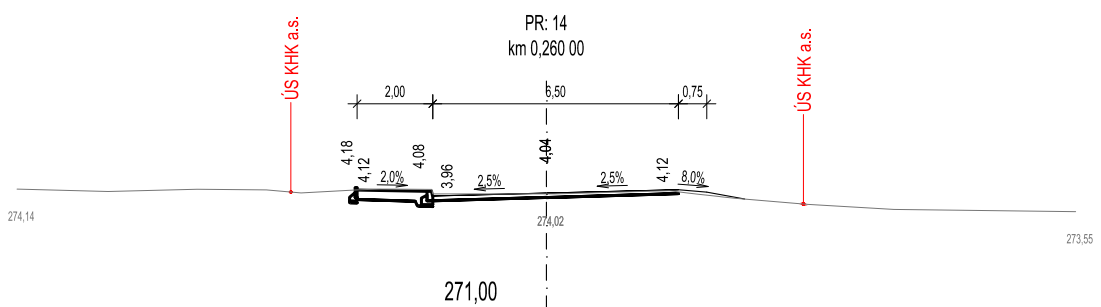
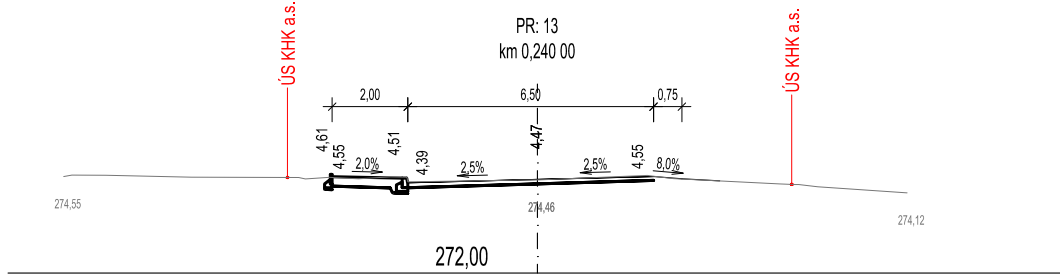
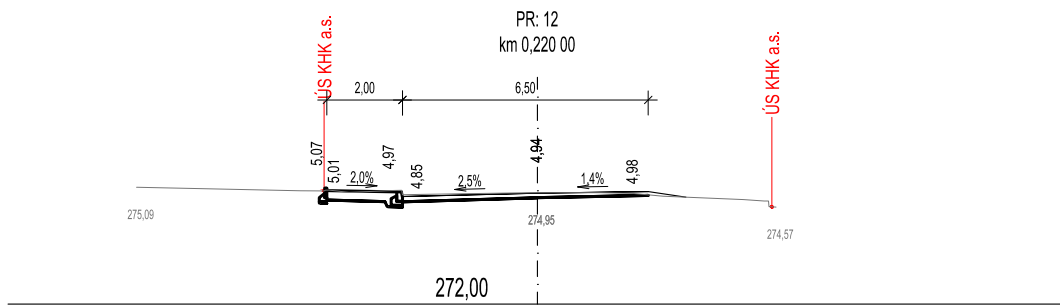
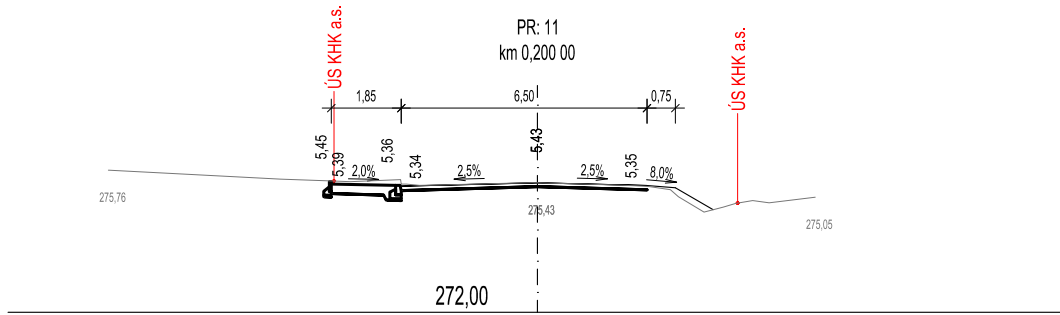

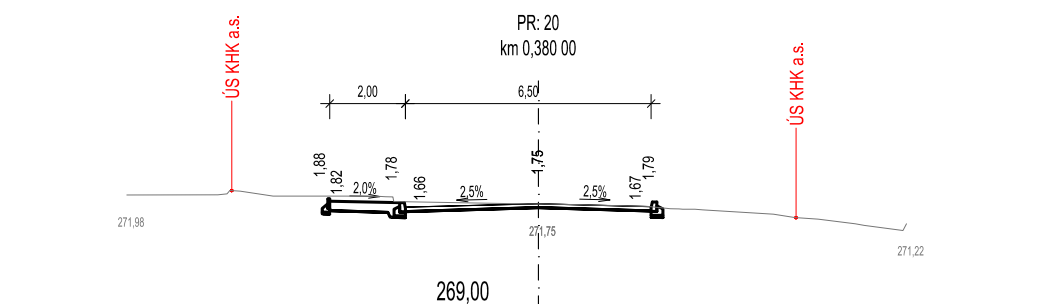
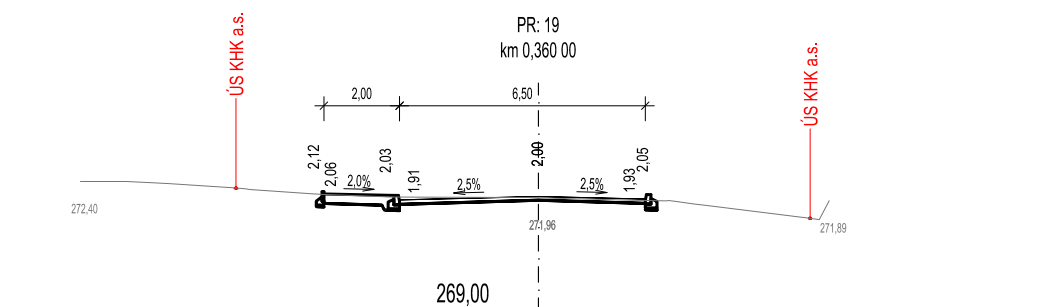
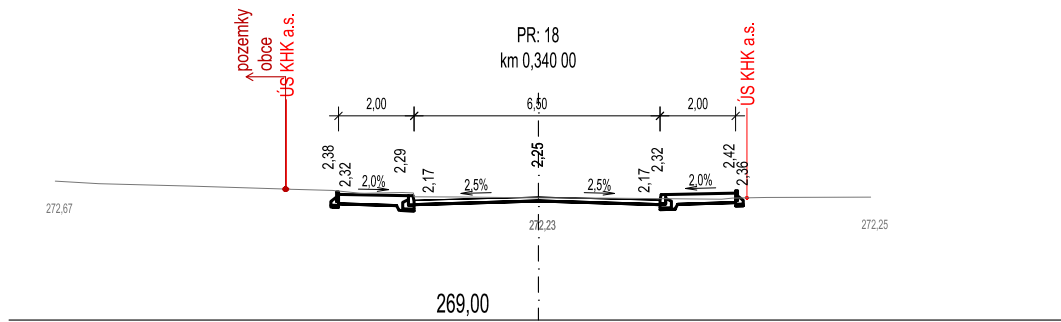
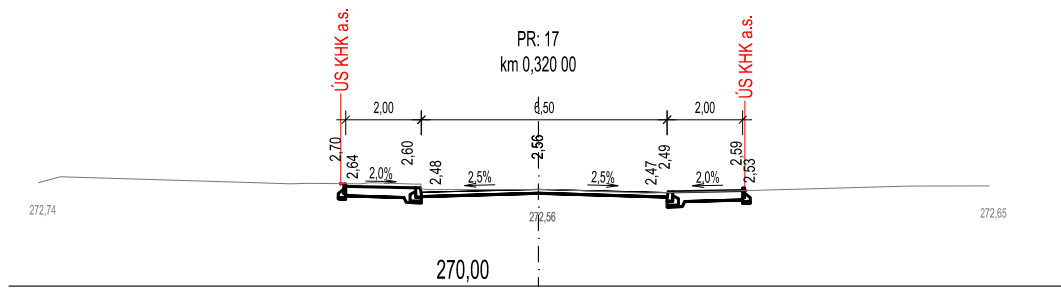
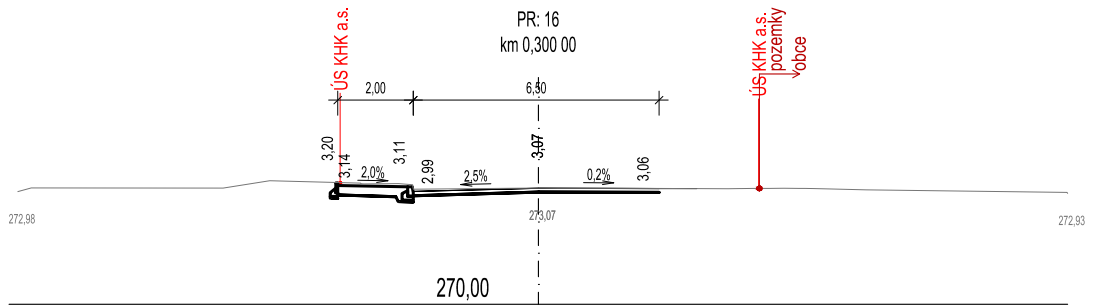

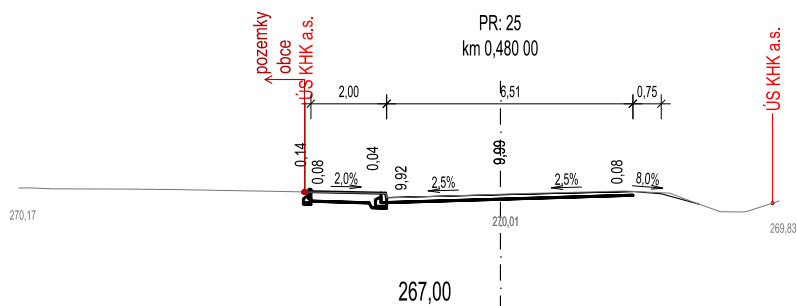
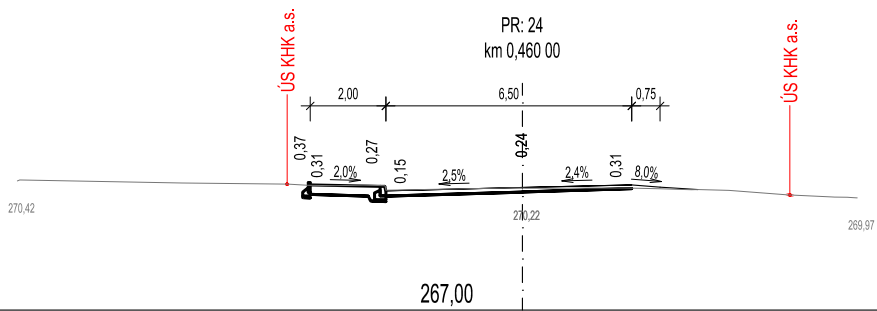
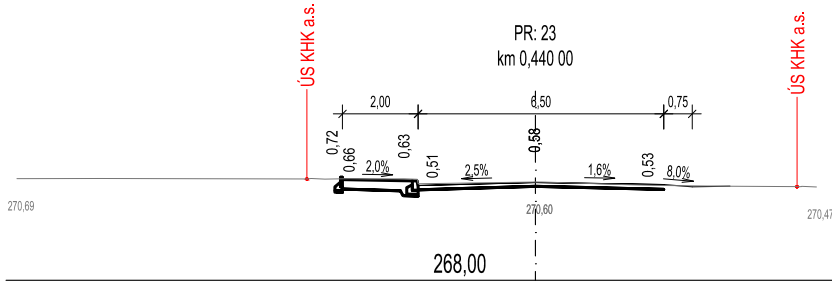
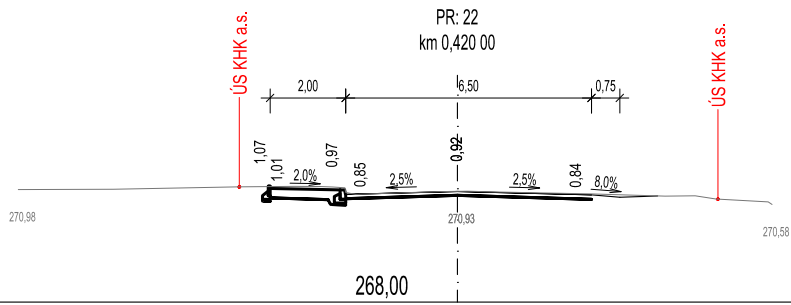
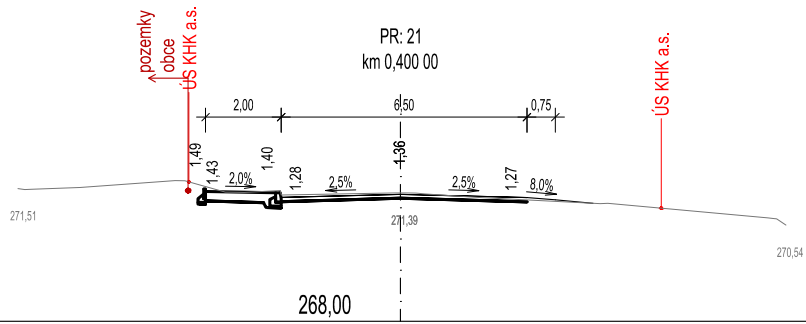

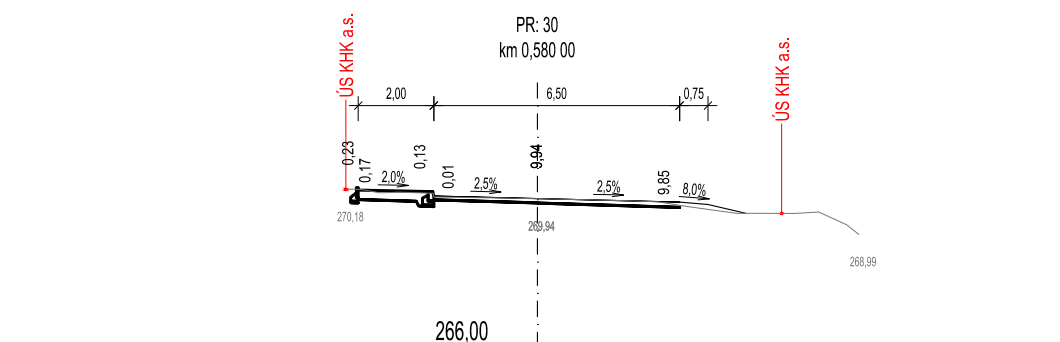
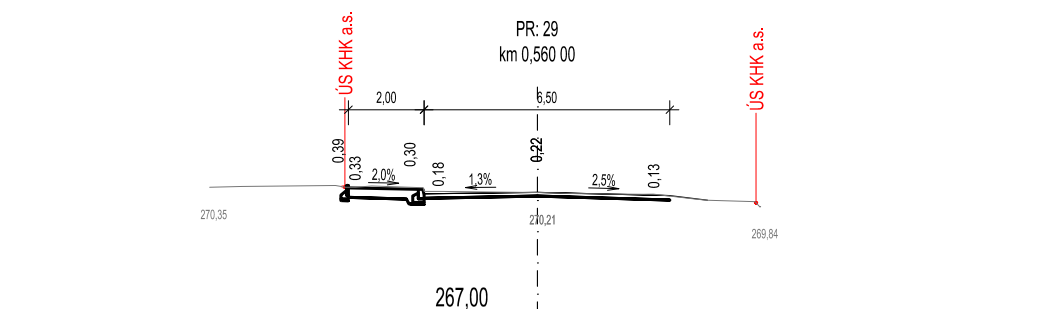
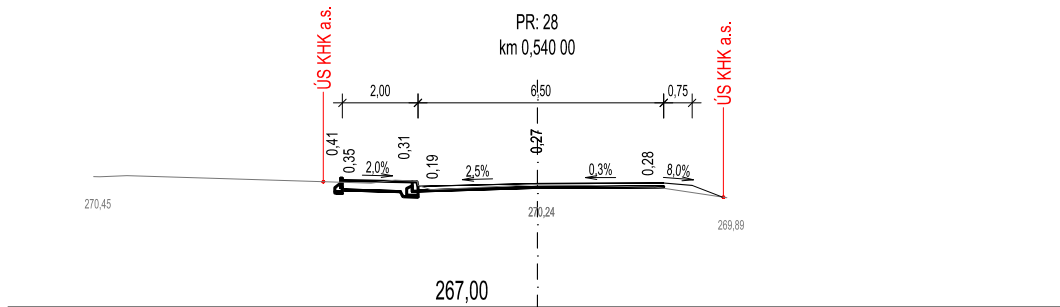
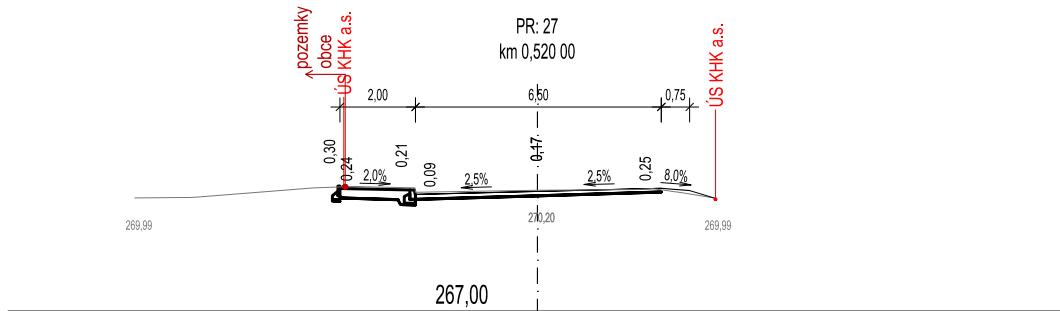
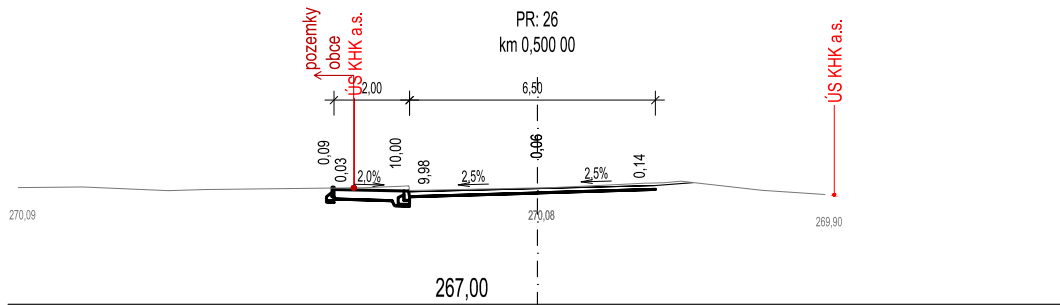

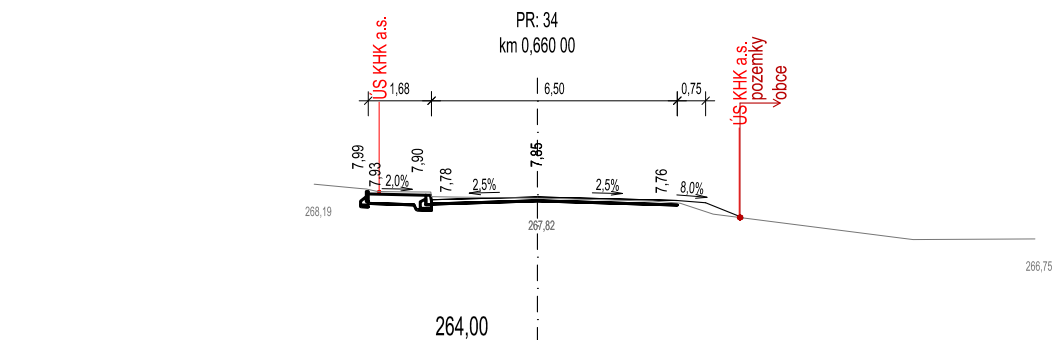
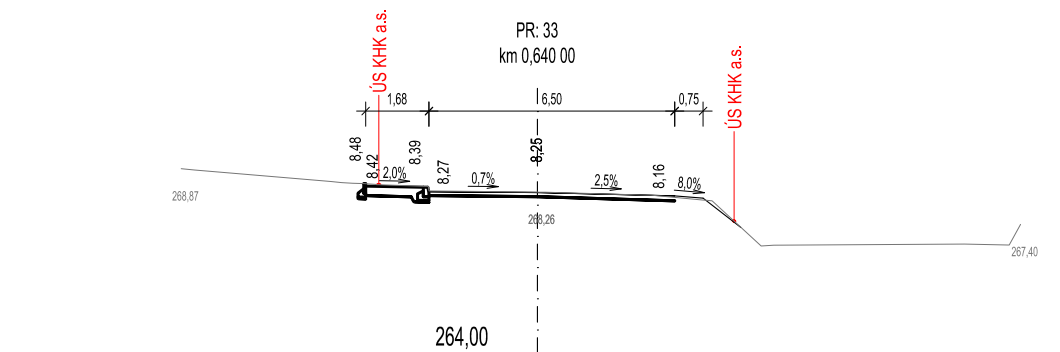
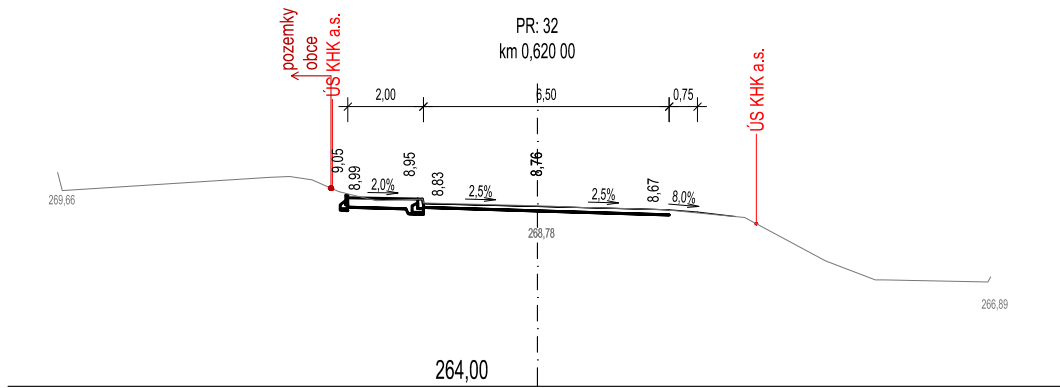
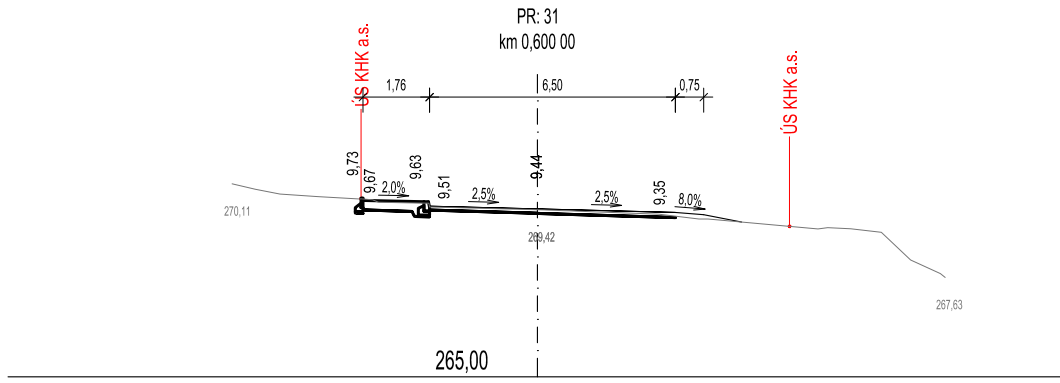

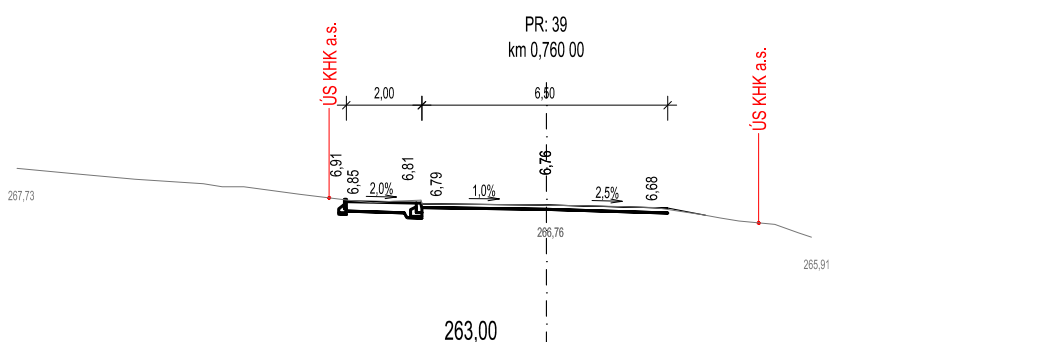
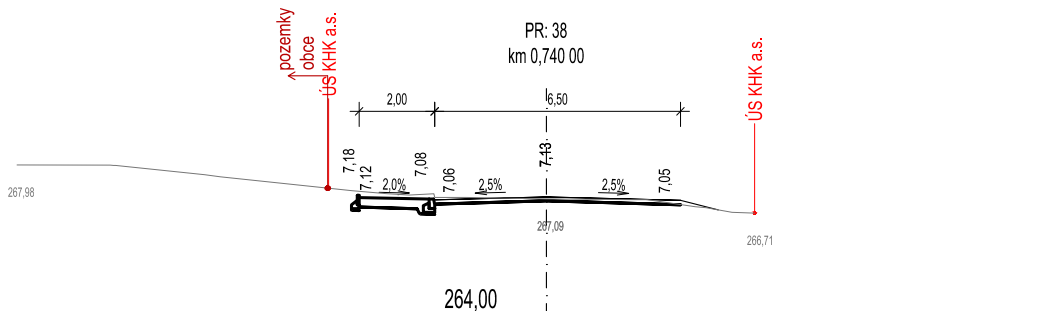
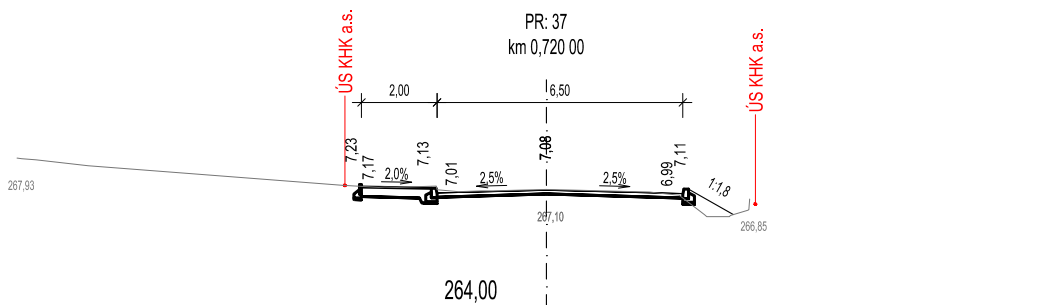
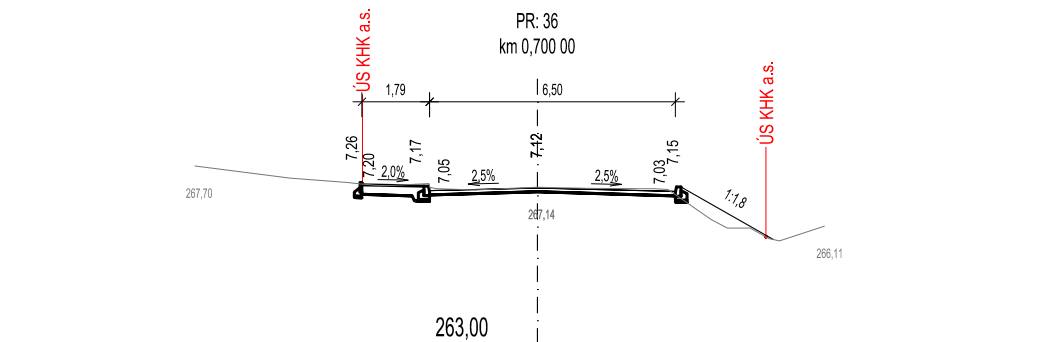
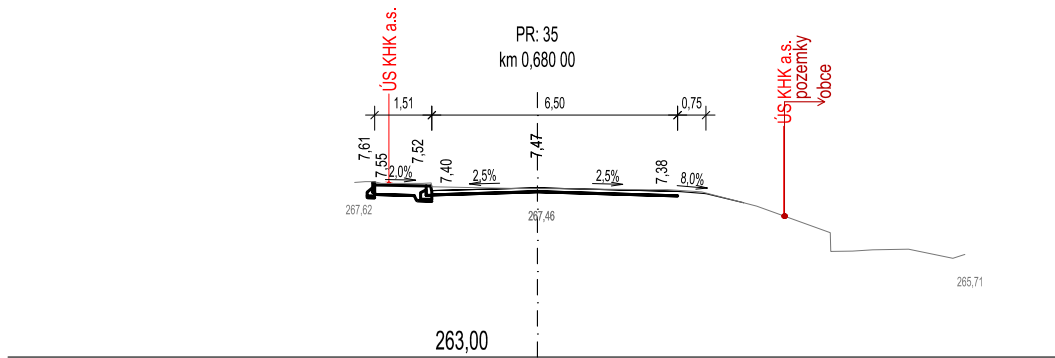

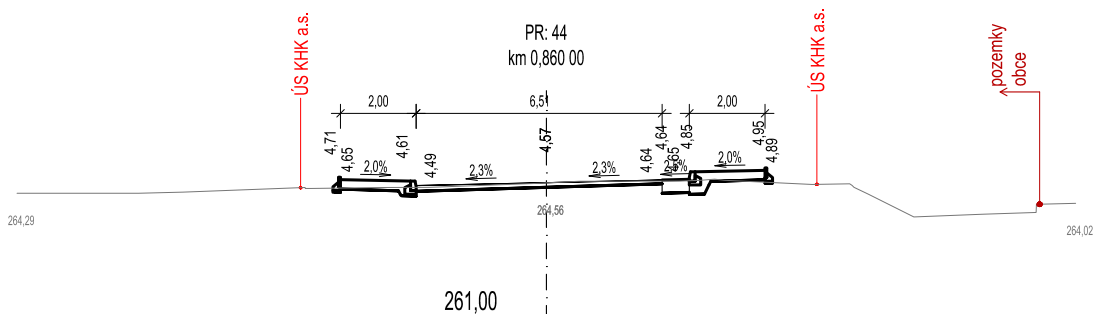
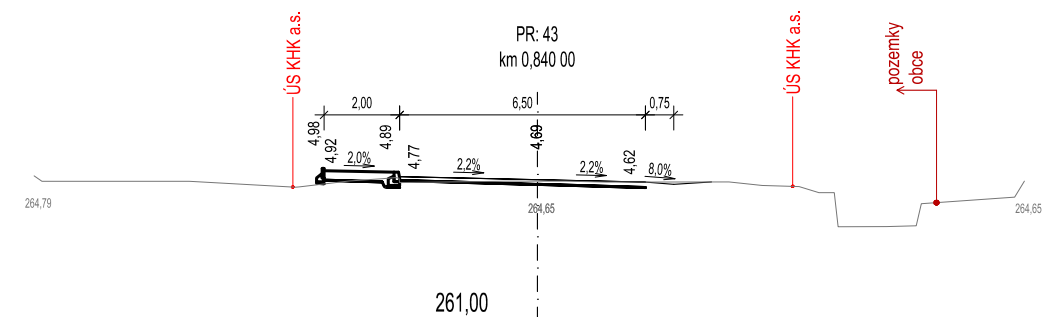
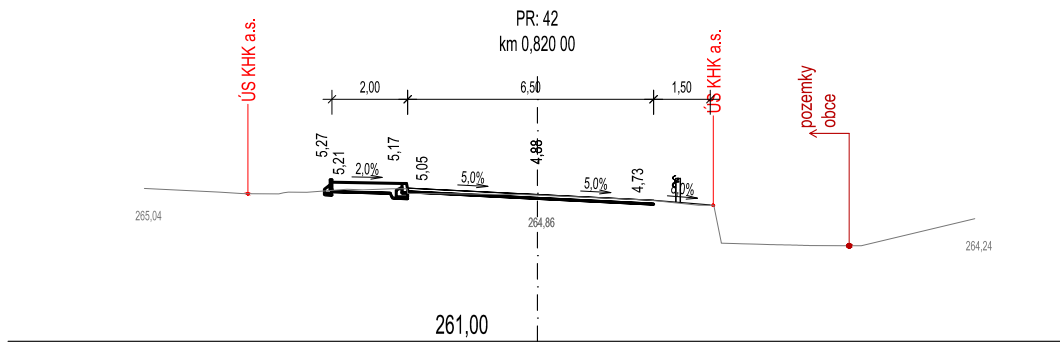
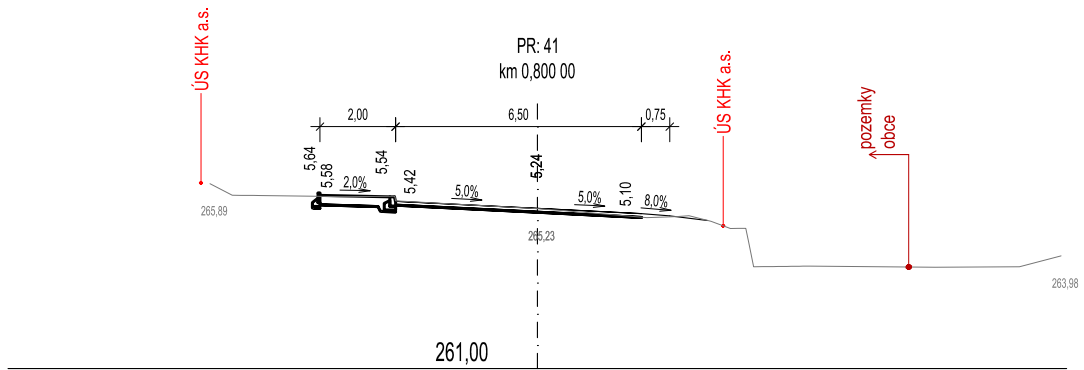
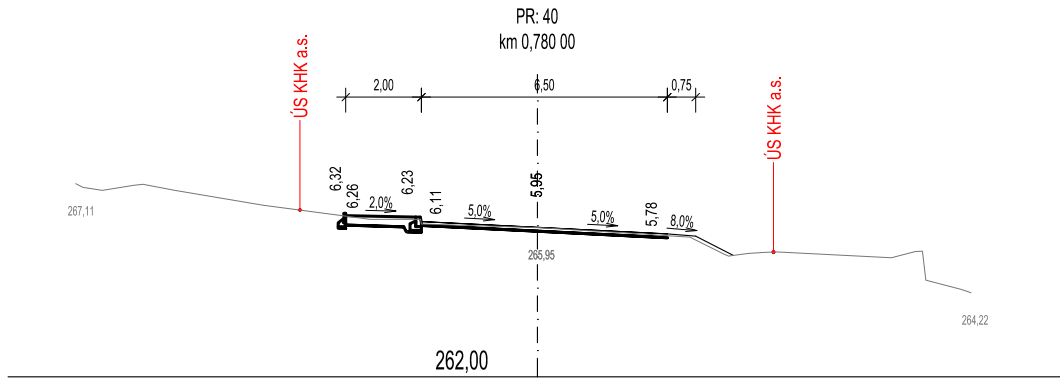

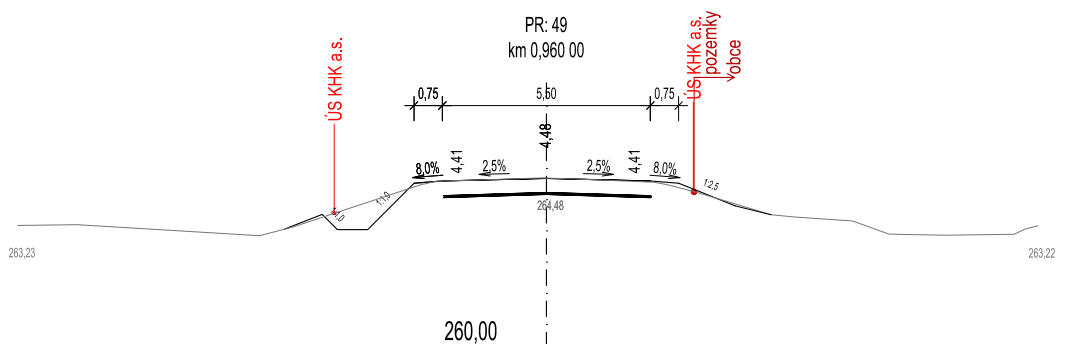
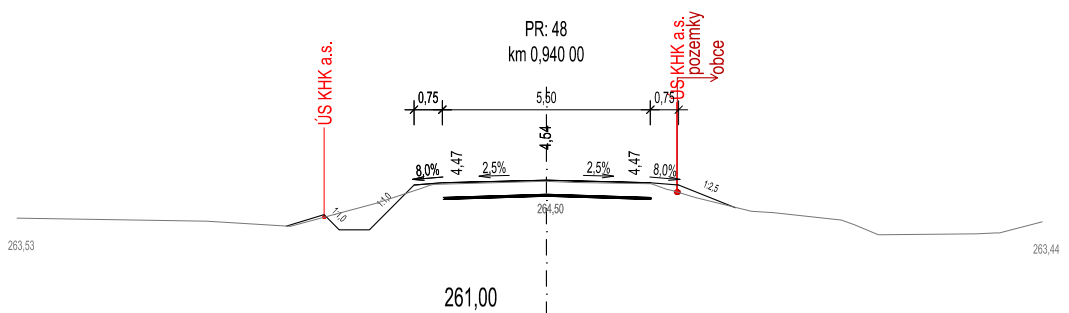
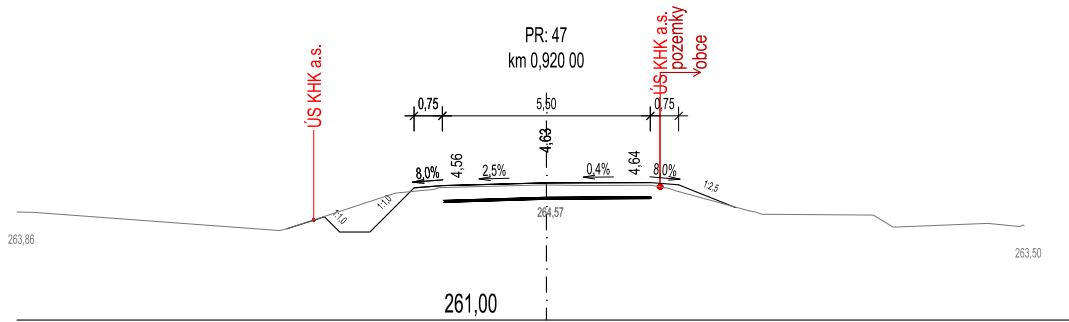
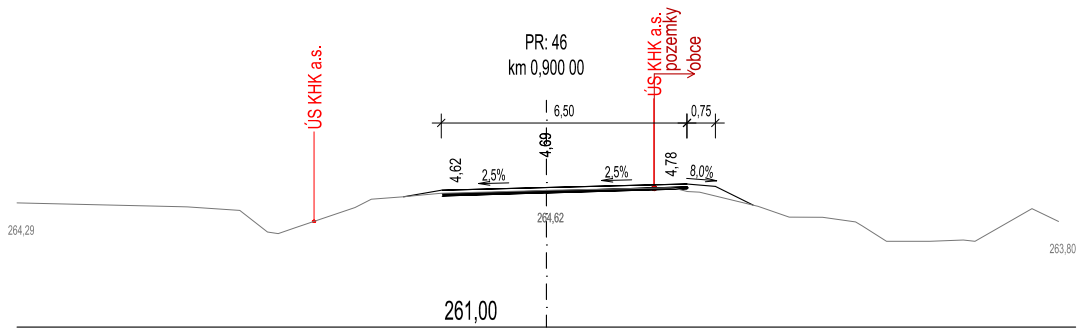
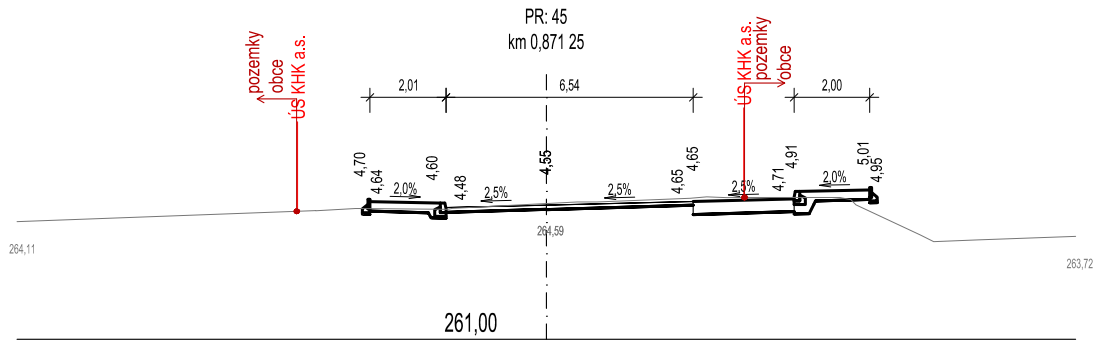

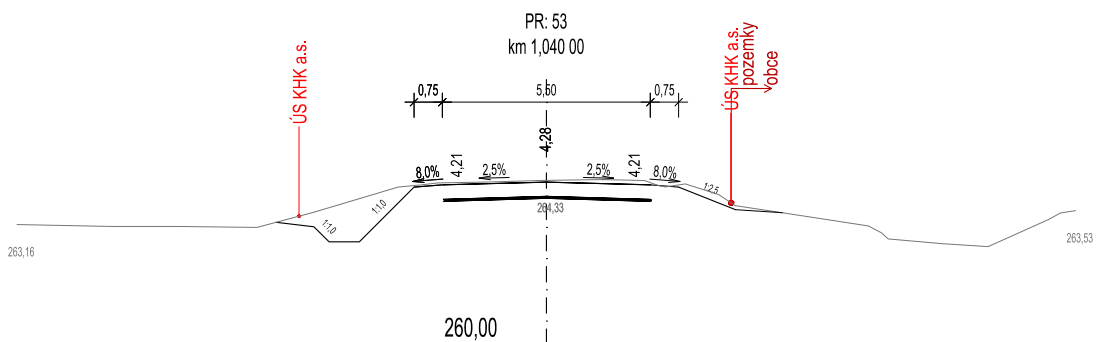
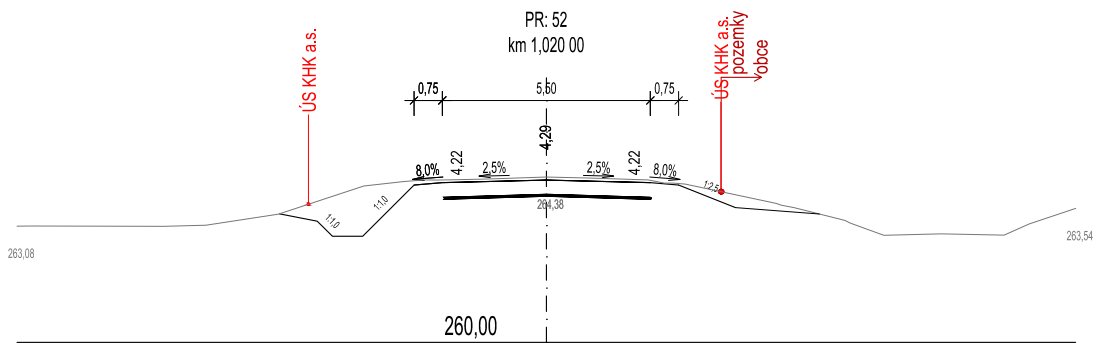
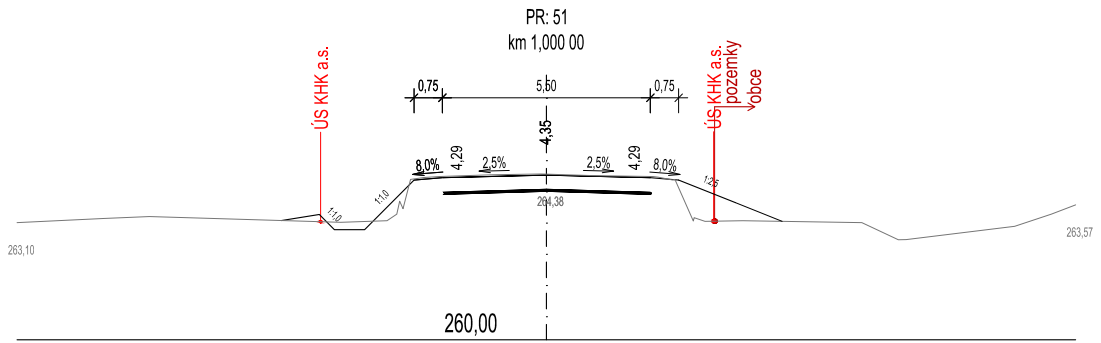
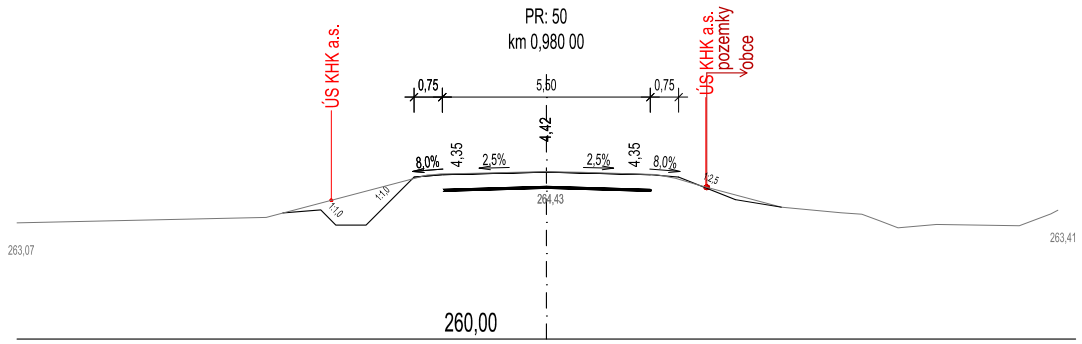

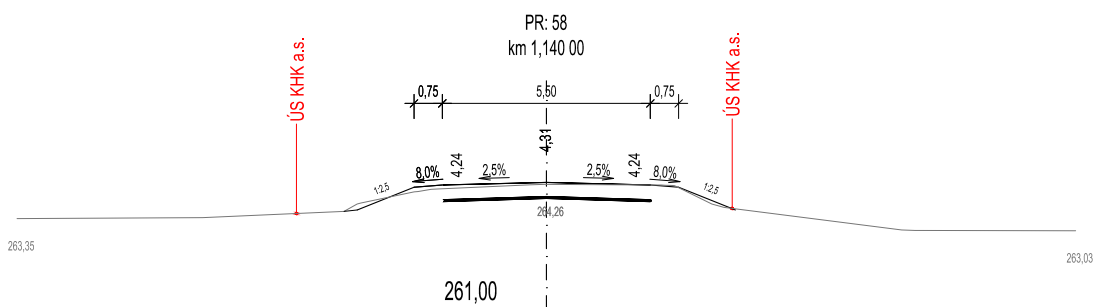
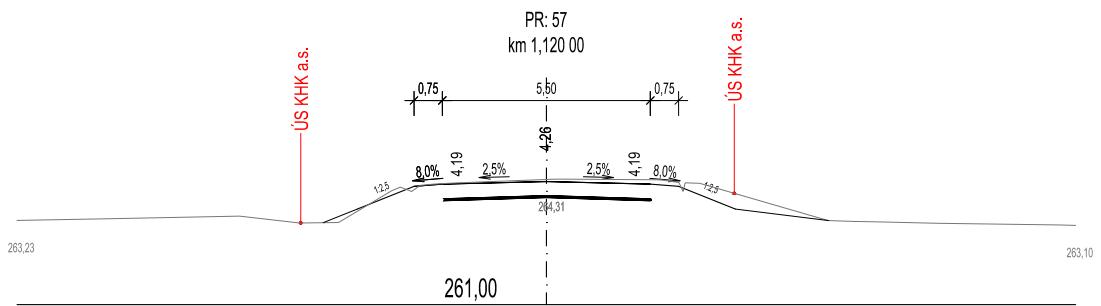
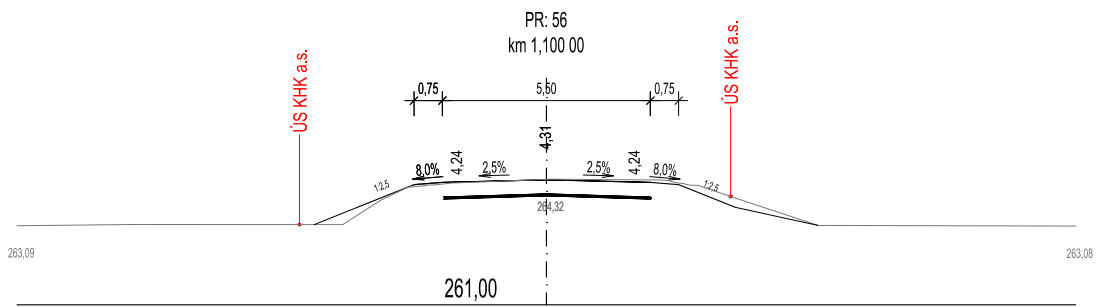
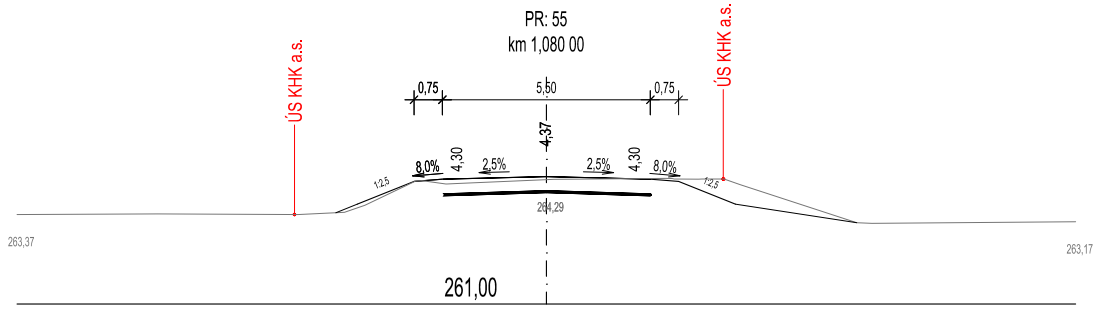
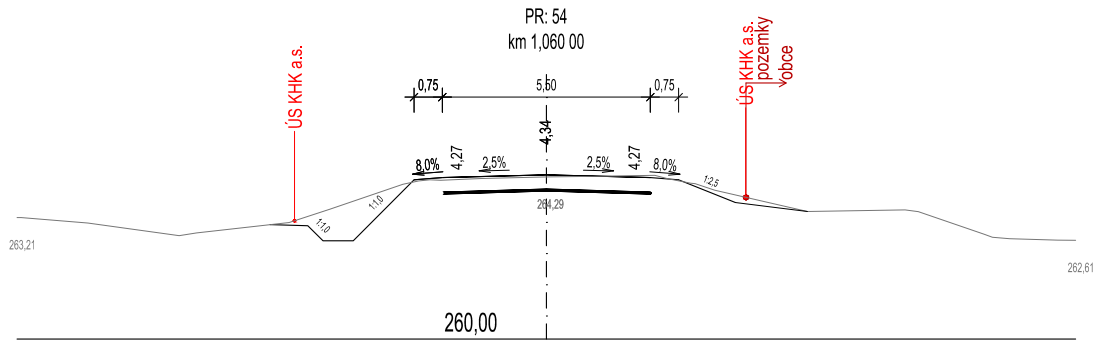

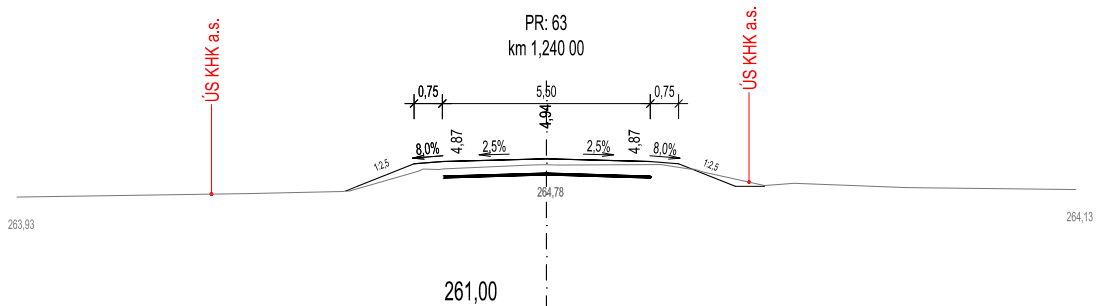
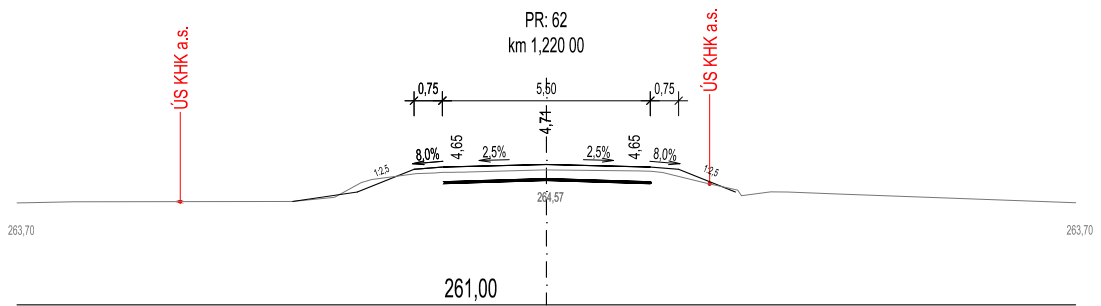
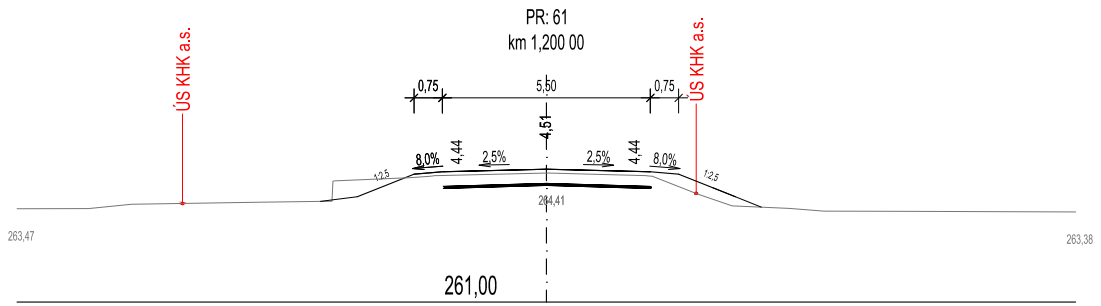
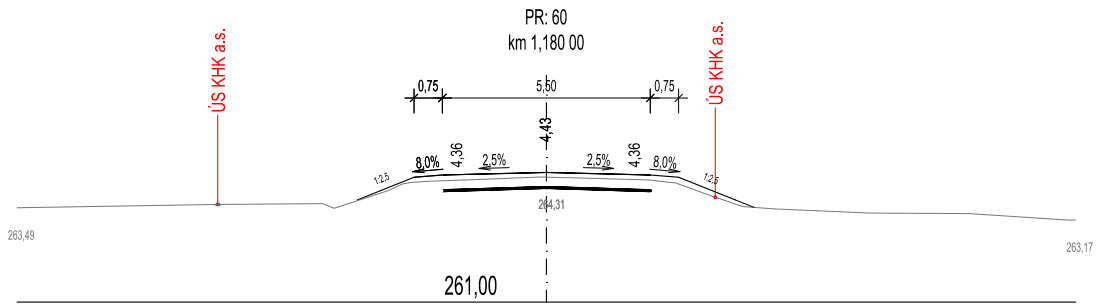
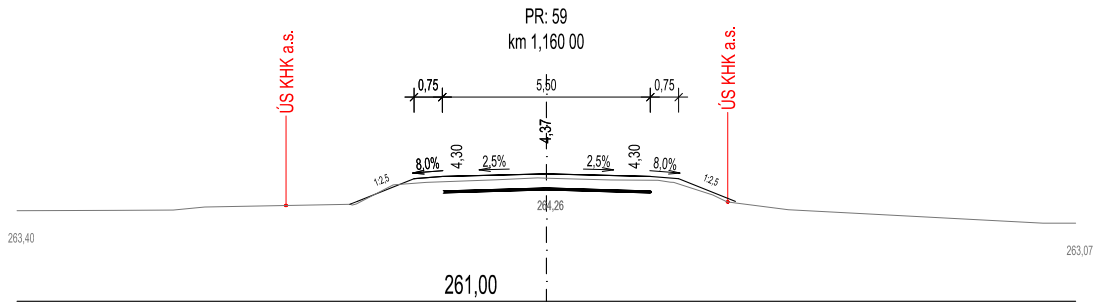

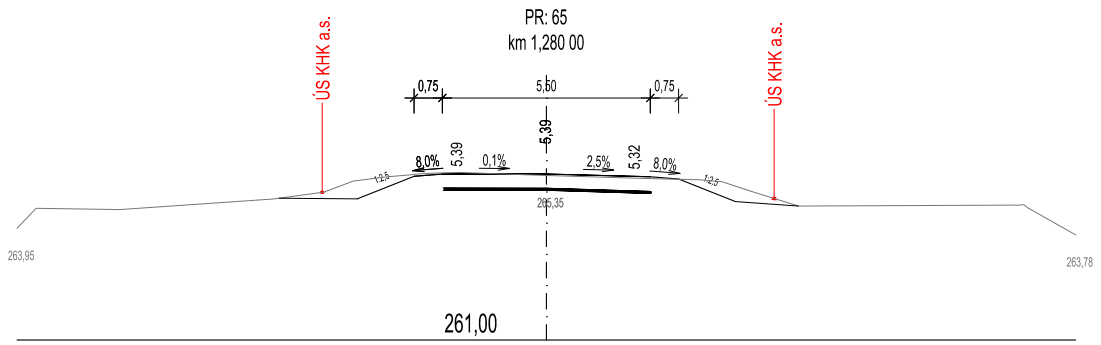
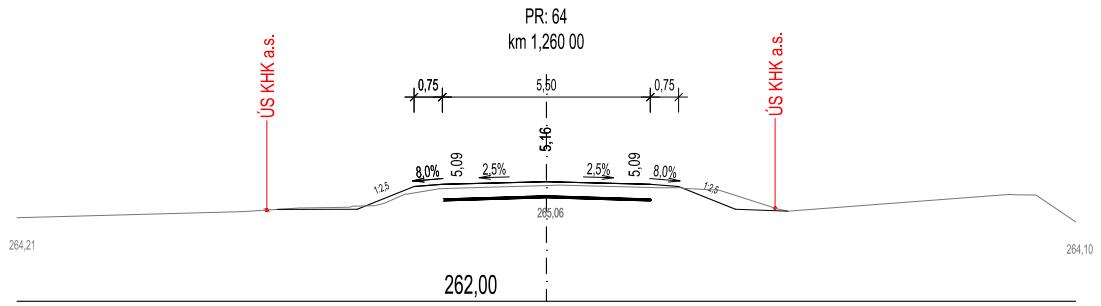

PR: 66
km 1,300 00 - stávající most

