

*DESERT*  
*HABITAT*  
**SIWA**  
**OASIS**

*Bc. Jakub Fišera*

# content

- 01** **DESERT OVERVIEW**
- 02** **SAHARE TRADE**
  - Trans sahara trade route
  - Winds of Sahara
- 03** **DESERTIFICATION**
- 04** **LOCATION OF THE PROJECT**
  - geogrphy
  - hydrogeology
  - Siwa Oasis
  - Traditional architecture
- 05** **TECHNOLOGY**
- 06** **UBRAN DESIGN**
  - design methodology
  - project documentation
- 07** **CLUSTER 2 - ARCHITECTURAL DESIGN**
  - architectural concept
  - project documentation

## **Bibliography**

Siwa Oasis - Actions for a sustainable development, Politecnico di Bari, ISBN 978-8895006-13-0

Architecture of emergence, Michael Wienstock, ISBN 978-0-470-06632-1

Abd El-Aziz El-Rahman Aldumairy, Siwa past and present, Alexandria, 2005

Vivian C., The Western Desert of Egypt, 2000

other research papers are listed for each chapter or theme



01

# DESERT

## Overview

Deserts have been defined and classified in a number of ways, generally combining total precipitation, number of days on which this falls, temperature, and humidity, and sometimes additional factors. A non-technical definition is that deserts are those parts of the Earth's surface that have insufficient vegetation cover to support a human population

*Deserts are sometimes classified as hot or cold, semiarid or coastal*

### HOT

high temperatures in summer  
greater evaporation than precipitation usually exacerbated by high temperatures  
strong winds  
lack of cloud cover

Winter temperatures vary considerably between different deserts and are often related to the location of the desert on the continental landmass and the latitude. Daily variations in temperature can be as great as 22 °C (40 °F) or more, with heat loss by radiation at night being increased by the clear skies

### COLD

occur at higher latitudes than hot deserts, and the aridity is caused by the dryness of the air. Some cold deserts are far from the ocean and others are separated by mountain ranges from the sea and in both cases there is insufficient moisture in the air. The largest of these deserts are found in Central Asia

Polar deserts are a particular class of cold desert. The air is very cold and carries little moisture so little precipitation occurs and what does fall, usually as snow, is carried along in the often strong wind and may form blizzards, drifts and dunes similar to those caused by dust and sand in other desert regions

### *Based on precipitation alone*

#### HYPERARID

This deserts receive less than 25 mm of rainfall a year; they have no annual seasonal cycle of precipitation and experience twelve-month periods with no rainfall at all

#### ARID

Arid deserts receive between 25 and 200 mm in a year

#### SEMIARID

Semiarid deserts receive between 200 and 500 mm in a year

However, such factors as the temperature, humidity, rate of evaporation and evapotranspiration, and the moisture storage capacity of the ground have a marked effect on the degree of aridity and the plant and animal life that can be sustained

#### COASTAL

Coastal deserts are mostly found on the western edges of continental land masses in regions where cold currents approach the land or cold water upwellings rise from the ocean depths. The cool winds crossing this water pick up little moisture and the coastal regions have low temperatures and very low rainfall, the main precipitation being in the form of fog and dew



*the sahara desert*

*Deserts are also classified, according to their geographical location and dominant weather pattern*

**trade wind, mid-latitude, rain shadow, coastal, monsoon**

**TRADE WIND**

Trade wind deserts occur either side of the horse latitudes at 30° to 35° North and South. These belts are associated with the subtropical anticyclone and the large-scale descent of dry air moving from high-altitudes toward the poles - **Sahara**



*the tengger desert*

**MID-LATITUDE**

occur between 30° and 50° North and South. They are mostly in areas remote from the sea where most of the moisture has already precipitated from the prevailing winds - **Tengger, Sonoran desert**



*the thar desert*

**MONSOON**

differences occur between sea and land. Moist warm air rises over the land, deposits its water content and circulates back to sea. Further inland, areas receive very little precipitation - **The Thar desert**

**RAIN SHADOW EFFECT**

Geographic lift occurs as air masses rise to pass over high ground. In the process they cool and lose much of their moisture by precipitation on the windward slope of the mountain range. When they descend on the leeward side, they warm and their capacity to hold moisture increases so an area with relatively little precipitation occur - **Taklamakan desert**



*the taklamakan desert*

**MONTANE DESERT**

arid places with a very high altitude. Many locations within this category have elevations exceeding 3,000 m, and the thermal regime can be hemiboreal. These places owe their profound aridity (the average annual precipitation is often less than 40 mm) to being very far from the nearest available sources of moisture and are often in the lee of mountain ranges - **Tibetan Plateau**

**POLAR DESERT**

ice-free because of the dry katabatic winds that flow downhill from the surrounding mountains - **McMurdo Dry Valleys**



# DESERT

## climate

### *Köppen climate classification*

There are usually two or three variations of a desert climate: a hot desert climate (BWh), a cold desert climate (BWk) and, sometimes, a mild desert climate (BWh/BWn). An area that features this climate usually experiences from 25 to 200 mm (7.87 inches) per year of precipitation

### **HOT DESERT CLIMATE**

typically found under the subtropical ridge where there is largely unbroken sunshine for the whole year due to the stable descending air and high pressure aloft. These areas are located between 30 degrees south and 30 degrees north latitude. Hot desert climates usually feature hot, sometimes exceptionally hot, periods of the year. In many locations featuring a hot desert climate, maximum temperatures of over 40 °C. During colder periods of the year, night-time temperatures can drop to freezing or below due to the exceptional radiation loss under the clear skies. Hot desert climates can be found in the deserts of North Africa such as the wide Sahara Desert, the Libyan Desert or the Nubian Desert; deserts of the Horn of Africa such as the Danakil Desert or the Grand Bara Desert; deserts of Southern Africa such as the Namib Desert or the Kalahari Desert; deserts of the Middle East such as the Arabian Desert, the Syrian Desert or the Lut Desert; deserts of South Asia such as the Thar Desert; deserts of the United States and Mexico such as the Mojave Desert, the Sonoran Desert or the Chihuahuan Desert

deserts of Australia such as the Simpson Desert or the Great Victoria Desert and many other regions. Only one region in Europe has a hot desert climate, Province of Almeria, Province of Alicante and Province of Murcia in South Eastern Spain

### **COLD DESERT CLIMATE**

Cold desert climates (BWk) sometimes feature hot and dry summers, though summers typically are not quite as hot as summers in hot desert climates. Unlike hot desert climates, cold desert climates sometimes feature cold winters with marginal snow. Cold desert climates are typically found at higher altitudes than hot desert climates, and are usually drier than hot desert climates. A cold desert climate is typically found in temperate zones, almost always in the rain shadow of high mountains which restrict precipitation from the westerly winds, or in the case of Central Asia, from the monsoon. The Gobi desert in Mongolia is a classic example of a region with a cold desert climate. Though hot in summer, it shares the very cold winters of the rest of Central Asia. The Kyzyl Kum and Taklamakan deserts of Central Asia and the drier portions of the Great Basin Desert of the western United States are other major examples of BWk climates. The Ladakh region, lying in the Great Himalayas in India, also has a cold desert climate

### **MILD DESERT CLIMATE**

Mild desert climates (BWh or BWn) are usually found along the west coasts of continents at tropical or near tropical locations, or at high altitudes in areas that would otherwise feature hot desert climates. In South America, this climate is found adjacent to the Pacific Ocean in sections of the Atacama Desert, especially along the central and southern coast of Peru

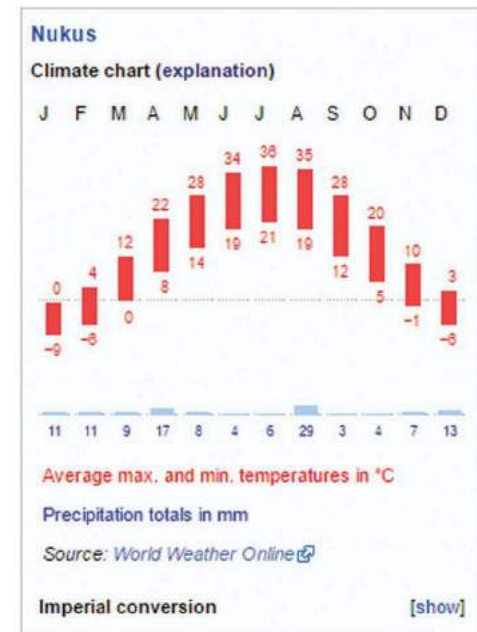
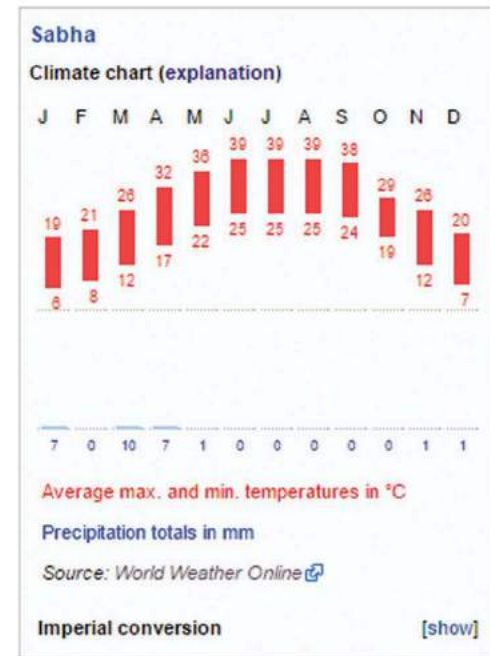



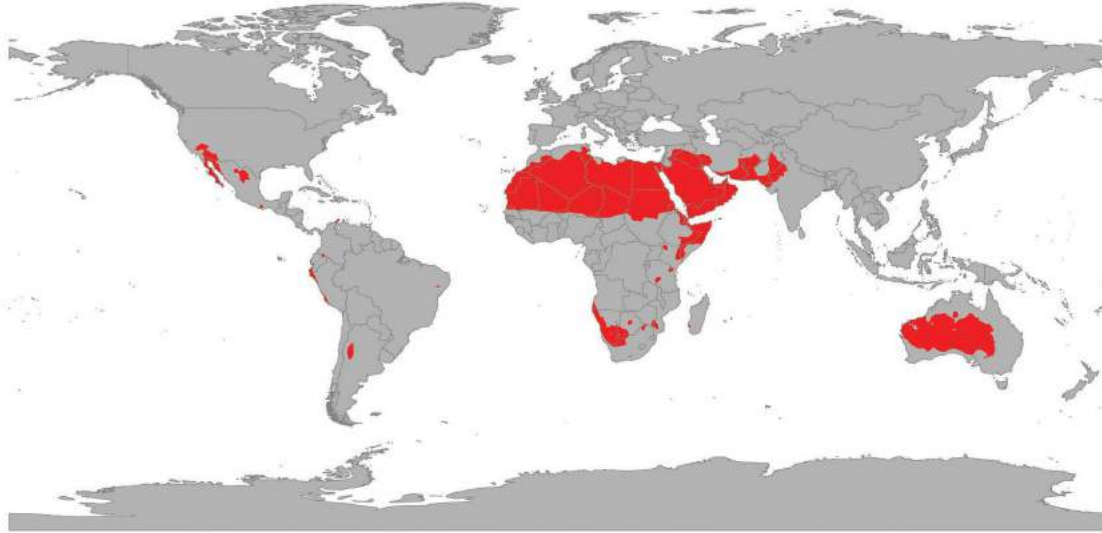

Af	<b>BWh</b>	Csa	Cwa	Cfa	Dsa	Dwa	Dfa	ET
Am	BWk	Csb	Cwb	Cfb	Dsb	Dwb	Dfb	EF
Aw	BSh	Cwc	Cfc	Dsc	Dwc	Dfc		
	BSk			Dsd	Dwd	Dfd		

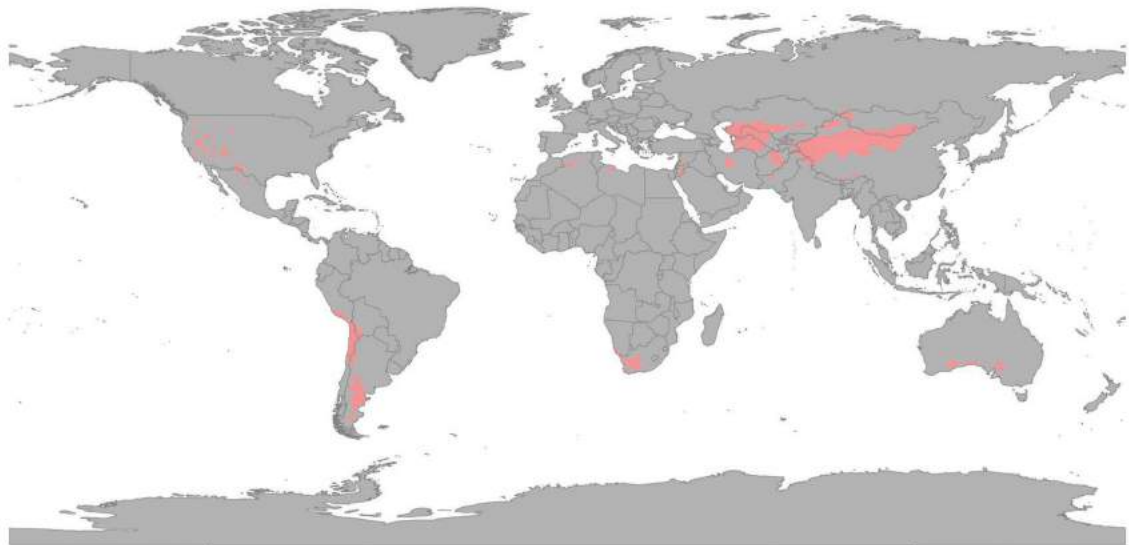

Af	BWh	Csa	Cwa	Cfa	Dsa	Dwa	Dfa	ET
Am	<b>BWk</b>	Csb	Cwb	Cfb	Dsb	Dwb	Dfb	EF
Aw	BSh	Cwc	Cfc	Dsc	Dwc	Dfc		
	BSk			Dsd	Dwd	Dfd		

# DESERT

## features

Across the world, around 20% of desert is sand, varying from only 2% in North America to 30% in Australia and over 45% in Central Asia. Where sand does occur, it is usually in large quantities in the form of sand sheets or extensive areas of dunes

A sand sheet is a near-level, firm expanse of partially **consolidated particles** in a layer that varies from a few centimeters to a few meters thick. The structure of the sheet consists of thin horizontal layers of coarse silt and very fine to medium grain sand, separated by layers of coarse sand and pea-gravel which are a single grain thick. These larger particles **anchor** the other particles in place. Small ripples form on the sand sheet when the wind exceeds 24 km/h (15 mph). They form perpendicular to the wind direction and gradually move across the surface as the wind continues to blow. The distance between their crests corresponds to the average length of jumps made by particles during saltation

### SAND DUNES

Sand dunes are accumulations of windblown sand piled up in mounds or ridges. They form downwind of copious sources of dry, loose sand and occur when topographic and climatic conditions cause airborne particles to settle. As the wind blows, **saltation and creep** take place on the windward side of the dune and individual grains of sand move uphill. When they reach the crest, they cascade down the far side. The upwind slope typically has a gradient of 10° to 20°

while the lee slope is around 32°, the angle at which loose dry sand will slip. As this wind-induced movement of sand grains takes place, the dune moves slowly across the surface of the ground. Dunes are sometimes solitary, but they are more often grouped together in dune fields. When these are extensive, they are known as sand seas or **ergs**

*A large part of the surface area of the world's deserts consists of flat, stone-covered plains dominated by wind erosion*

In "eolian deflation", the wind continually removes fine-grained material, which becomes wind-blown sand. This exposes coarser-grained material, mainly pebbles with some larger stones or cobbles, leaving a desert pavement and the ground becomes stable. Evaporation brings moisture to the surface by capillary action and calcium salts may be precipitated, binding particles together to form a desert conglomerate. In time, bacteria that live on the surface of the stones accumulate a film of minerals and clay particles, forming a shiny brown coating known as desert varnish

### DESERT VARNISH

**Desert varnish or rock varnish is an orange-yellow to black coating found on exposed rock surfaces in arid environments. Desert varnish is usually around one micrometer thick**

Other non-sandy deserts consist of exposed outcrops of bedrock, dry soils or aridisols, and a variety of landforms affected by flowing water, such as alluvial fans, sinks or playas, temporary or permanent lakes, and oases

**A hamada** is a type of desert landscape consisting of a high rocky plateau where the sand has been removed by aeolian processes

Other landforms include plains largely covered by gravels and angular boulders, from which the finer particles have been stripped by the wind. These are called "reg" in the western Sahara, "serir" in the eastern Sahara





## WATER

One of the driest places on Earth is the Atacama Desert. It is virtually devoid of life because it is blocked from receiving precipitation by the Andes mountains. precipitation in the Chilean region of Antofagasta is just 1 mm. Evidence suggests that the Atacama may not have had any significant rainfall from 1570 to 1971. Nevertheless, there is some plant life in the Atacama, in the form of specialist plants that obtain moisture from dew and the fogs

### the Llaireta

The Llaireta is highly resistant to abiotic stress; for example, its cushion body allows to modify the physical characteristics of their environment, reducing wind speed and controlling the temperature differences. It grows at a height between 3000 and 5000 meters above sea level, in nutritionally poor and any measure pH soils, and has the ability to survive under drought, high temperature and solar radiation. The plant grows at a rate of approximately one millimeter per year. At this growth rate, many plants at this site would be about 850 years old, and occasional individuals could be as old as 3000 years

### *Syntrichia caninervis*

Tiny fibres attached to the tips of the moss leaves, known as awns, allow *S. caninervis* to harvest fog and mist droplets. four modes: nucleation of water droplets and films on the leaf hair from humid atmospheres; collection of fog droplets on leaf hairs; collection of splash water from raindrops; and transportation of the acquired water to the leaf itself

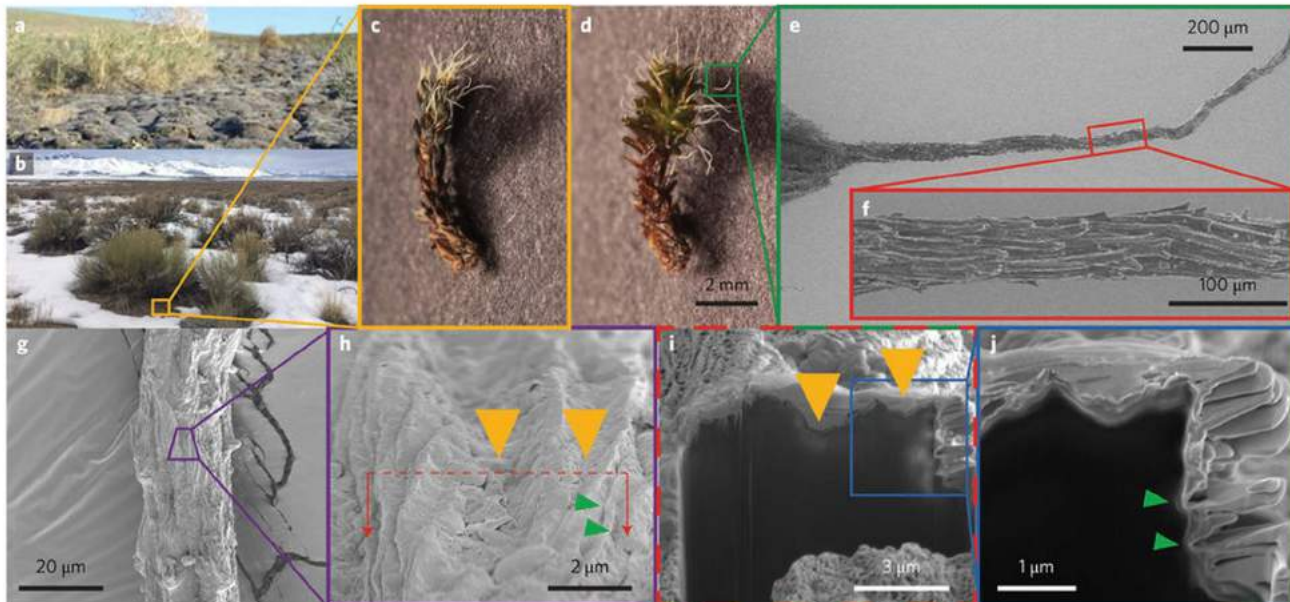

# DESERT

## sand dunes

*In physical geography, a dune is a hill of loose sand built by wind or the flow of water. Dunes occur in different shapes and sizes, formed by interaction with the flow of air or water. Although the most widely distributed dunes are those associated with coastal regions, the largest complexes of dunes are found inland in dry regions and associated with ancient lake or sea beds*

### AEOLIAN DUNE SHAPES

#### Crescentic or transverse

Crescent-shaped mounds are generally wider than they are long. The slipfaces are on the concave sides of the dunes. These dunes form under winds that blow consistently from one direction, and they also are known as barchans, or transverse dunes. Some types of crescentic dunes move more quickly over desert surfaces than any other type of dune. A group of dunes moved more than 100 metres per year between 1954 and 1959 in China's Ningxia Province

#### Lunettes

Fixed crescentic dunes that form on the leeward margins of playas and river valleys in arid and semiarid regions in response to the direction(s) of prevailing winds. They may be composed of clay, silt, sand, or gypsum, eroded from the basin floor or shore, transported up the concave side of the dune, and deposited on the convex side

#### Linear

Straight or slightly sinuous sand ridges typically much longer than they are wide are known as linear dunes. They may be more than 160 kilometres (100 miles) long. Some linear dunes merge to form Y-shaped compound dunes. Many form in bidirectional wind regimes

#### Star

Radially symmetrical, star dunes are pyramidal sand mounds with slipfaces on three or more arms that radiate from the high center of the mound. They tend to accumulate in areas with multidirectional wind regimes. Star dunes grow upward rather than laterally. They dominate the Grand Erg Oriental of the Sahara

#### Dome

Oval or circular mounds that generally lack a slipface. Dome dunes are rare and occur at the far upwind margins of sand seas

#### Parabolic

U-shaped mounds of sand with convex noses trailed by elongated arms are parabolic dunes. These dunes are formed from blow-out dunes where the erosion of vegetated sand leads to a U-shaped depression. The elongated arms are held in place by vegetation. These dunes often occur in semiarid areas where the precipitation is retained in the lower parts of the dune. Most parabolic dunes do not reach heights higher than a few tens of metres. In plan view, these are U-shaped or V-shaped mounds of well-sorted, very fine to medium sand with elongated arms that extend upwind

#### Longitudinal (Seif) dunes

Longitudinal dunes (also called Seif dunes, after the Arabic word for "sword"), elongate parallel to the prevailing wind, possibly caused by a larger dune having its smaller sides blown away. Seif dunes are sharp-crested and are common in the Sahara. They range up to 300 m (980 ft) in height and 300 km (190 mi) in length. Seif dunes are thought to develop from barchans if a change of the usual wind direction occurs. **Simple** parabolic dunes have only one set of arms that trail upwind, behind the leading nose. **Compound** parabolic dunes are coalesced features with several sets of trailing arms. **Complex** parabolic dunes include subsidiary superposed or coalesced forms, usually of barchanoid or linear shapes

#### Reversing dunes

Occurring wherever winds periodically reverse direction, reversing dunes are varieties of any of the above shapes. These dunes typically have major and minor slipfaces

### COASTAL DUNES

Dunes form where the beach is wide enough to allow for the accumulation of wind-blown sand, and where prevailing onshore winds tend to blow sand inland. Obstacles tend to slow down the wind and lead to the deposition of sand grains. Models of coastal dunes suggest that their final equilibrium height is related to the distance between the water line and where vegetation can grow

#### NABKHA DUNES

small dune anchored by vegetation. They usually indicate desertification or soil erosion

1 A ripple or dune advances by the movements of individual grains of sand. The whole form moves forward slowly as sand erodes from the windward slope and is deposited on the leeward slope.

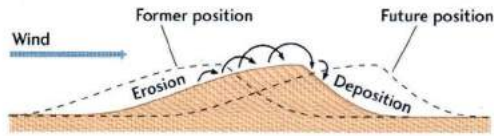

2 Particles of sand arriving on the windward slope of the dune move by saltation over the crest,...



3 ...where the wind velocity decreases and the sand deposited slips down the leeward slope.



4 This process acts like a conveyor belt that moves the dune forward.

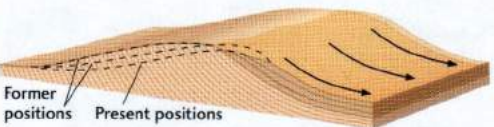

5 The dune stops growing vertically when it reaches a height at which the wind is so fast that it blows the sand grains off the dune as quickly as they are brought up.

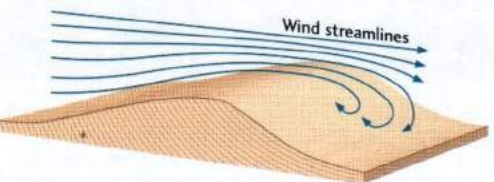
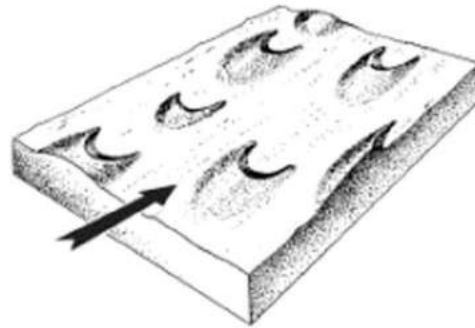
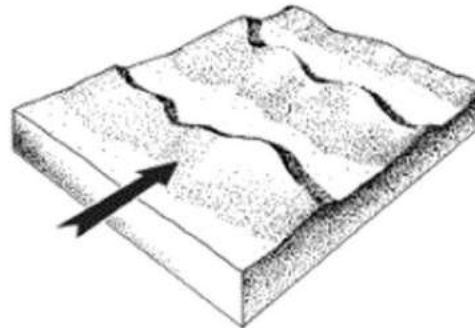

FIGURE 19.11 ■ Sand dunes grow and move as wind transports sand particles by saltation.



BARCHAN DUNES. Arrow shows prevailing wind direction.



BARCHANOID RIDGE. Arrow shows prevailing wind direction.

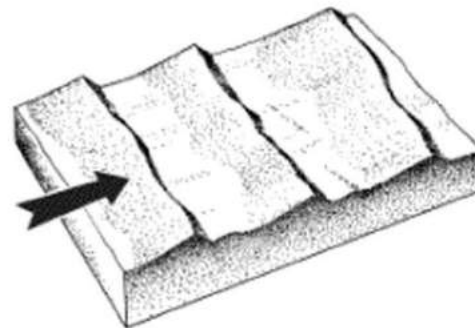

TRANSVERSE DUNE. Arrow shows prevailing wind direction.

Figure 3. From McKee, 1979

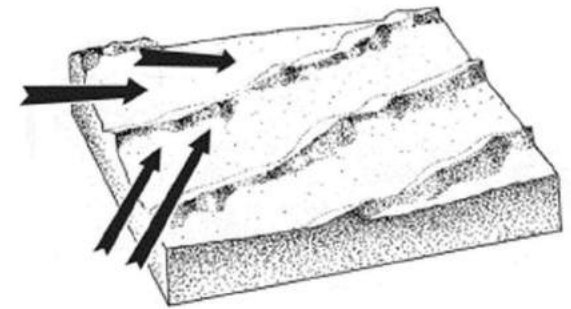

LINEAR DUNES. Arrows show probable dominant winds.

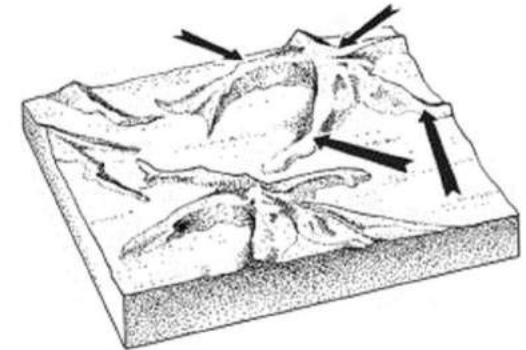

STAR DUNES. Arrows show effective wind directions.

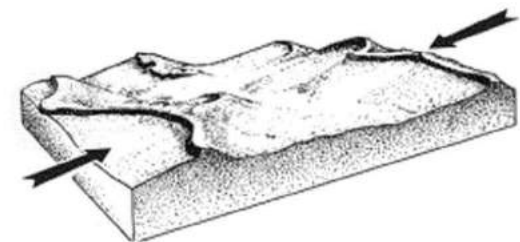

REVERSING DUNES. Arrows show wind directions.

Figure 4. From McKee, 1979

## DESERT

### landformrs from wind

*deflation hollows are an example of wind erosion causing deflation yet these depressions also tend to collect rainwater and hold this water for a time depending on evaporation rates through the stones*

#### DEFLATION HOLLOWLS

Dune deflation hollows are where wind has removed sand down to a level where a layer of particles too heavy for the wind to move (an armoured surface) stabilises the sand and prevents the surface being lowered further. They often form between a series of sand dunes and when the dunes move further inland they enlarge the terminal deflation hollow behind. Initially the hollows are colonised by small plants such as sand sedge (*Carex pumila*), *Zoysia pauciflora*, and remuremu (*Selliera radicans*) and then by progressively taller plants over time such as knobby club rush (*Ficinia nodosa*). This system may grade into damp sand plains where the water table is permanently near the surface. Dune deflation hollows can be the most species rich sites within the larger sand dune system

#### The Qattara Depression

depression in the north west of Egypt in the Matruh Governorate and is part of the Western Desert. It lies below sea level and is covered with salt pans, sand dunes and salt marshes The Qattara Depression contains the second lowest point in Africa at  $-133$  metres ( $-436$  ft) below sea level, the lowest being Lake Assal in Djibouti

The depression covers about 19,605 square kilometres (7,570 sq mi), a size comparable to Lake Ontario or twice as large as Lebanon. Due to its size and proximity to the Mediterranean Sea shore, it has been studied for its potential to generate hydroelectricity

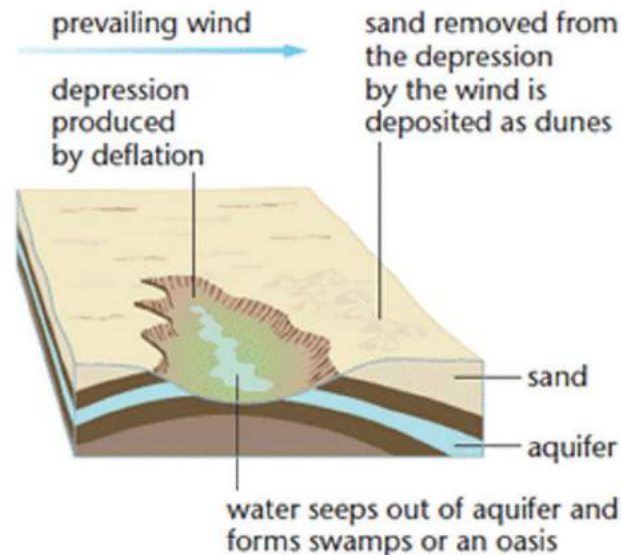
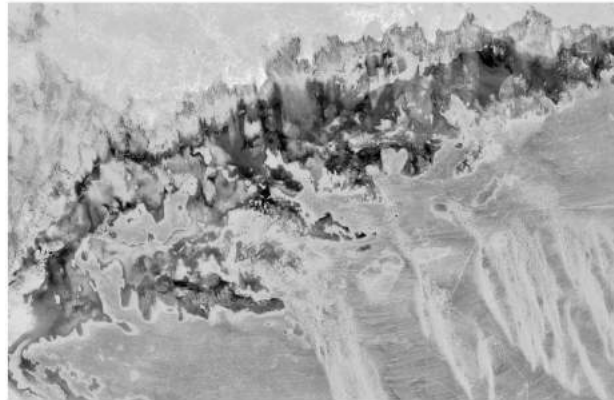

#### ZEUGEN

Tabular masses which have a layer of soft rocks lying beneath a surface layer of more resistant rocks. Difference in erosional effect of the wind on soft & resistant rock surfaces, carve them into weird looking ridge & furrow landscape. Mechanical weathering initiates their formation by opening up joints of the surface rocks. Wind abrasion further eats into underlying softer layer so that deep furrows are developed

The hard rocks then stand above the the furrows as ridges or Zeugen. Continuous abrasion by winds gradually lowers the Zeugen & widens the furrow



## YARDANGS

streamlined protuberance carved from bedrock or any consolidated or semiconsolidated material by the dual action of wind abrasion by dust and sand, and deflation which is the removal of loose material by wind turbulence.[1] Yardangs become elongated features typically three or more times longer than wide, and when viewed from above, resemble the hull of a boat. Facing the wind is a steep, blunt face that gradually gets lower and narrower toward the lee end.[2] Yardangs are formed by wind erosion, typically of an originally flat surface formed from areas of harder and softer material. The soft material is eroded and removed by the wind, and the harder material remains. The resulting pattern of yardangs is therefore a combination of the original rock distribution, and the fluid mechanics of the air flow and resulting pattern of erosion

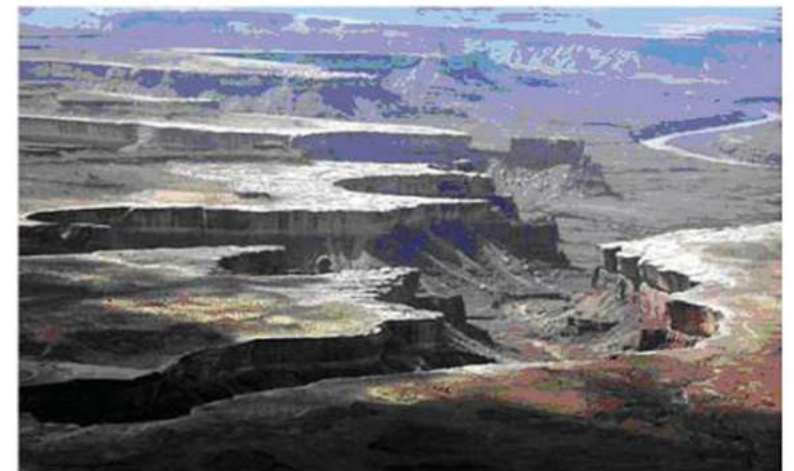
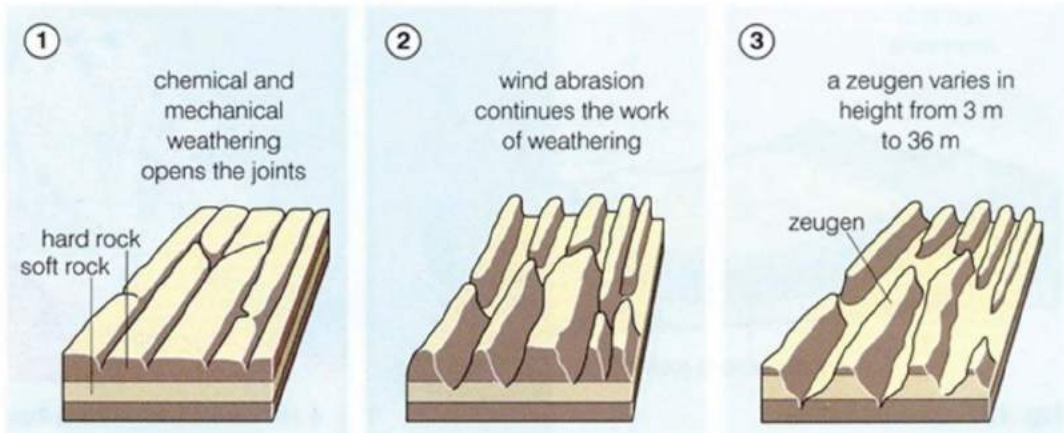
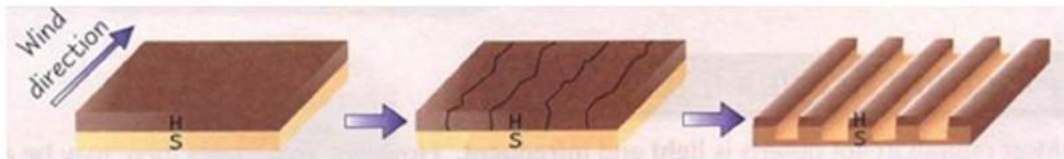
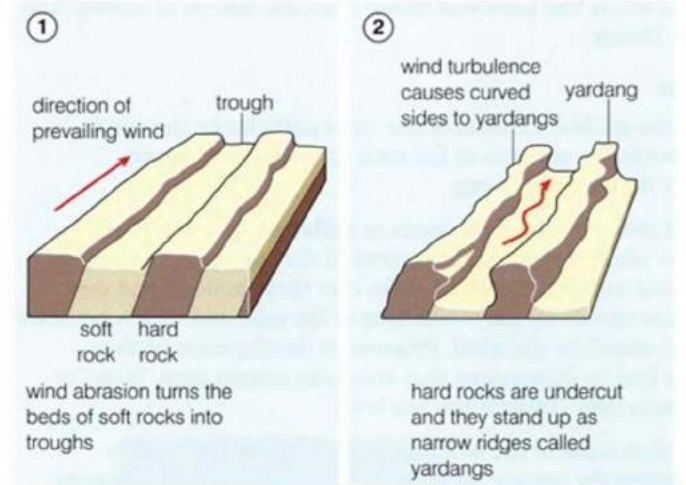
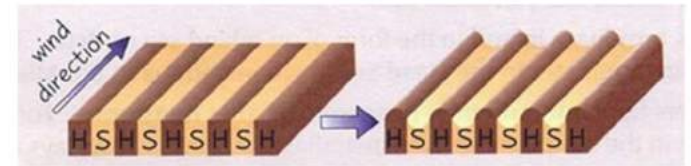





02

# TRANS-SAHARAN TRADE ROUTE

SOURCE: The third Nordic conference on Middle Eastern Studies  
<https://org.uib.no/smi/paj/Masonen.html>  
Joensuu, Finland, 19-22 June 1995

*In spite of her vast geographical dimensions and natural extremes, the Sahara has never been a barrier which had completely isolated Black Africa from other civilisations, in the same sense as the Atlantic Ocean separated the New World from the Old.*

The trans-Saharan trade was not merely an economic phenomenon, but it connected Western Africa to the Mediterranean world on the intellectual level, too. The regular commercial and cultural exchange between Western Africa and the Mediterranean world did not start properly until the 8th century AD. Yet the beginning of trans-Saharan trade was not such a sudden and dramatic event like the coming of Europeans to America, but it had a long history of sporadic encounters for more than 1000 years. There is also some archaeological evidence of the early contacts of West Africans with the classical world. Some Roman objects, dated to the 3rd century AD.

The real initiators of trans-Saharan trade were the Berber nomads who frequently crossed the desert with their camel flocks. The nomads, who resided at southern edge of Sahara, left to the north in the beginning of the rainy season, returning back by the eve of the dry season. In Sub-Saharan Africa there was a rich resource of gold. The gold was carried to the north, where it was probably used for payment of dates, corn and such handicrafts which the nomads could not produce themselves. The nomads may have bought also some luxury objects made in the Roman world, which they bartered for gold in the south.

The conditions of trans-Saharan trade changed remarkably after Northern Africa became a part of the Islamic world in the late 7th century AD. The vast Umayyid caliphate, reaching from the slopes of Pyrenees to the banks of Indus, formed a solid market area the monetary system of which was based on gold. There were three basic routes (There were seven primary north-south routes, six principal forest routes, and two west-east routes.) across the Sahara: the "western", leading from Sijilmasa to Awdaghust; the "central", and the most important, leading from Ifriqiya to the Niger bend; and

*the "Egyptian", leading from Egypt to the Niger bend via Siwa and Kufra.*

During the 500-1590 period, routes rose and declined in importance depending on the empire in power and the amount of security it could maintain for traders and trade routes.

In Western Africa, the contact zone was limited to the desert edge cities, where North African traders were isolated for their own quarters, lying usually outside the local dwelling. The principal reason why the North African traders were willing to accommodate in the local conditions in Western Africa, was the same as in the case of Europeans in China: it was the only way to continue the profitable trade. Before the European discovery of America, West African mines were the most important single source of gold both for Northern Africa and Europe.

The voluntary traffic of West Africans to the north began with the adoption of Islamic faith. Pilgrimage to Mecca is one of the five pillars of Islam, and in principle an obligation for all Muslims.

## Pattern of Trade.

By the eleventh century a typical caravan included one thousand camels. It might, for example, set out from Sijilmasa loaded with salt from Taghaza, foodstuffs, cloth, perfumes, and other goods from the Maghrib. Its next stop was Wadan, an oasis in the present-day nation of Mauritania, where some of the goods were sold and new items purchased; then the caravan went to Walata or Tichitt on the southern edge of the Sahara, and finally it went on to Timbuktu. From there the salt and other products would likely be taken by canoe to Niani or Djenné, where the salt was broken into smaller pieces and carried into the forest areas via the slave porters and donkeys of the Dyula-Wangara. These itinerant merchants traded the salt and other items from the north for forest gold, kola nuts, animal hides, and other products and then returned to Djenné, Niani, and Timbuktu. The number of camels on a return journey to Sijilmasa was typically less than half the number that arrived in Timbuktu because gold and other forest products were less bulky and much lighter in weight than the blocks of salt. The caravans would be guided by highly paid Berbers who knew the desert and could ensure safe passage from their fellow desert nomads. The survival of a caravan was precarious and would rely on careful coordination. Runners would be sent ahead to oases so that water could be shipped out to the caravan when it was still several days away, as the caravans could not easily carry enough with them to make the full journey.

The African Union and African Development Bank support the Trans-Sahara Highway from Algiers to Lagos via Tamanrasset which aims to stimulate trans-Saharan trade. The route is paved except for a 200 km section in northern Niger, but border restrictions still hamper traffic.

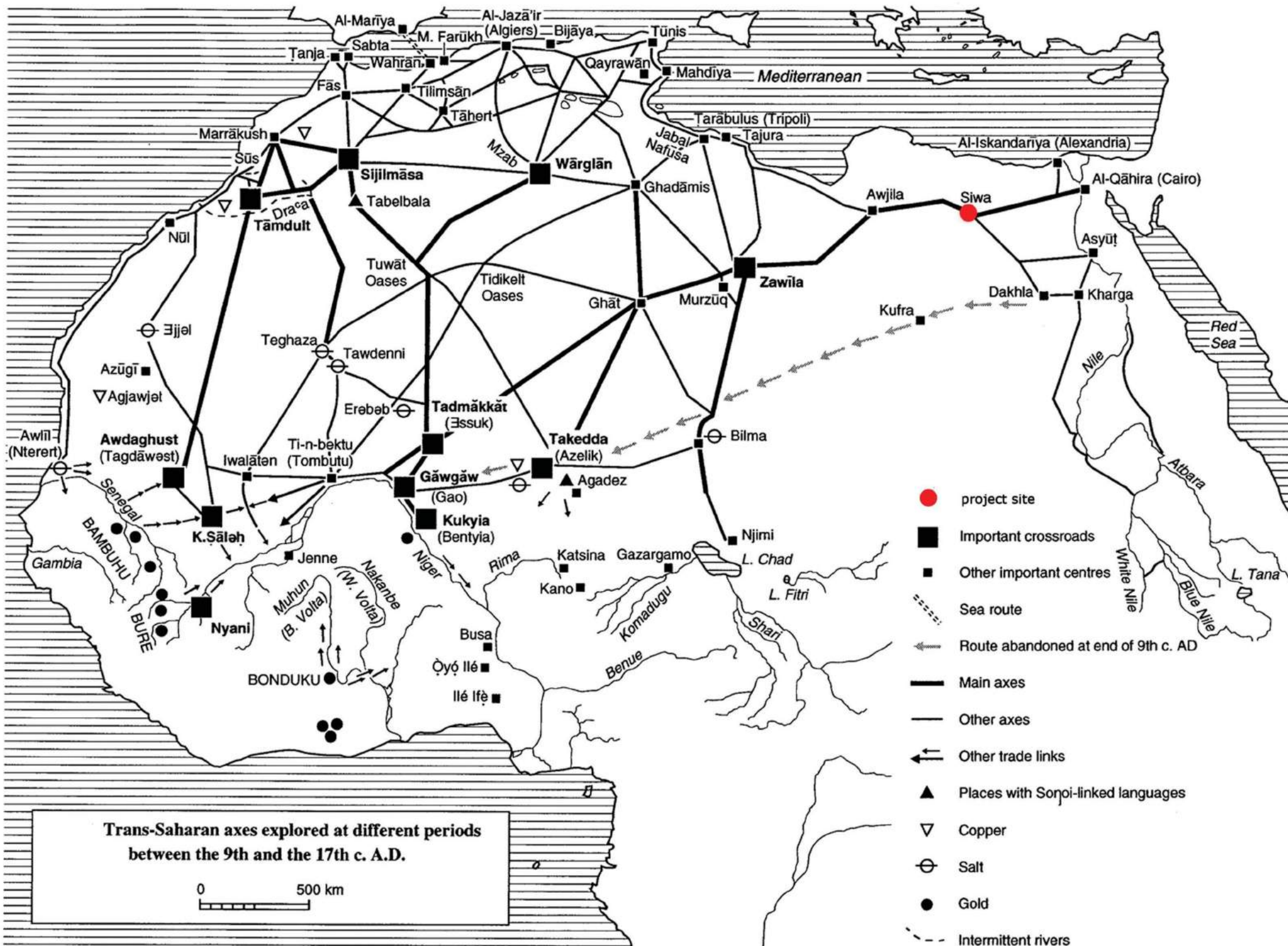

Trans-Saharan axes explored at different periods between the 9th and the 17th c. A.D.

0 500 km

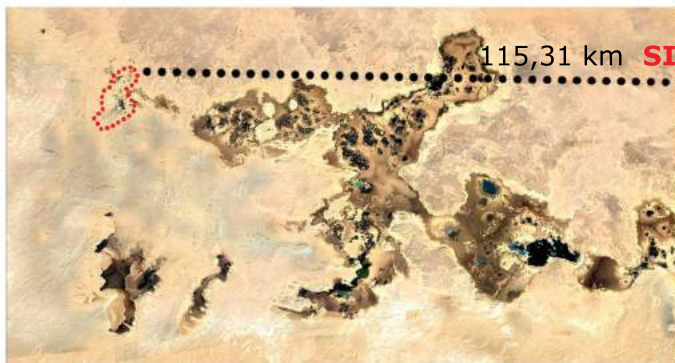

### Al Jaghub Oasis

The Al Jaghub Oasis is located on the northern edge of the Libyan Desert in a deep depression that is sunk about 10 m (33 ft) below sea level. To the north of the oasis are escarpments where the Al Jaghub Formation dating to the Middle Miocene is exposed. At Al Jaghub it is about 120 m (400 ft) thick and consists of white to yellow limestone, clay, marl and sandstone. It has **population about 2,800 inhabitants** The Siwa Oasis in western Egypt lies about 100 km to the southeast in a similar depression.



### Bahariya Oasis

It is approximately 370 km away from Cairo. The roughly oval valley extends from north-east to south-west, has a length of 94 km, a maximum width of 42 km and covers an area of about 2000 km<sup>2</sup>. Bahariya consists of many villages of which El Bawiti is the largest and the administrative center. It has **population about 30,000 inhabitants**. Located in Giza Governorate, the main economic sectors are agriculture, iron ore mining, and tourism. The main agricultural products are guavas, mangos, dates, and olives.

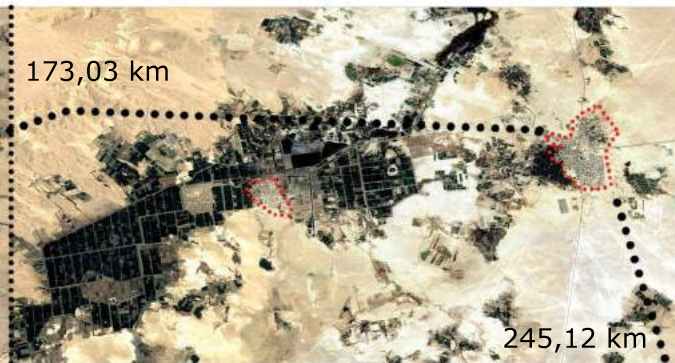

### The Farafra depression

It is the second biggest depression by size in Western Egypt and the smallest by population. Farafra has an estimated **5,000 inhabitants (2002)** mainly living in the town of Farafra and is mostly inhabited by the local Bedouins. Parts of the town have complete quarters of traditional architecture, simple, smooth, unadorned, all in mud colour. Due to its geographical location and geological formation it has more than 100 wells spread out over the lands of the Farafra, many of which natural. Most of these wells are used in aggregation of the cultivated land in the oasis.

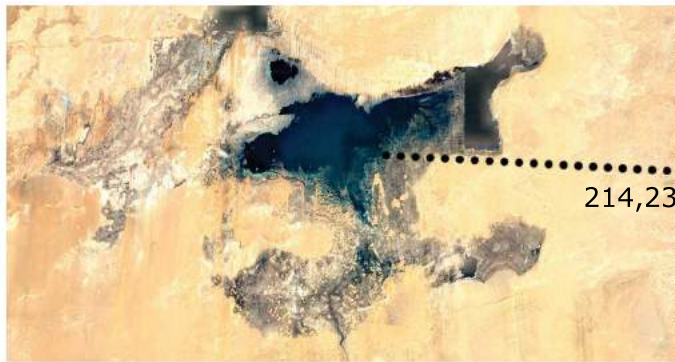

### Toshka Lakes

The Aswan High Dam, constructed in Egypt in 1964-1968, created Lake Nasser, with a maximum water level of 183 metres (600 ft) above sea level. In 1978 Egypt began building the Sadat Canal NW from Lake Nasser through Wadi Toshka to allow water levels higher than 178 metres (584 ft) to be drained off into a hollow at the south end of the Eocene limestone plateau. The Toshka Hollow lies within the seismically active Nubian Swell. The Egyptian government is developing the surrounding region, also known as the **"New Valley Project"**. The plan is to extend the waterway to the Kharga oasis.

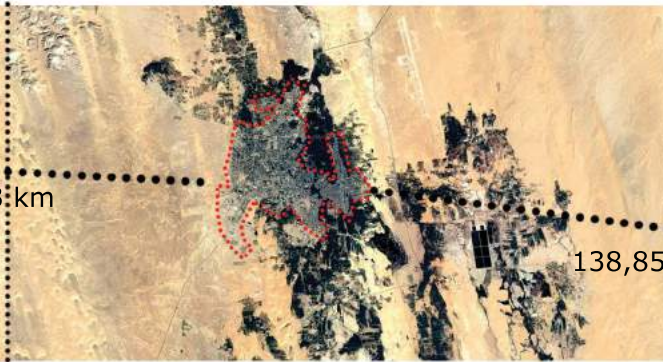

### The Kharga Oasis

It is the southernmost of Egypt's five western oases. It is located in the Western Desert, about 200 km (125 miles) to the west of the Nile valley. "Kharga" or "El Kharga" is also the name of a major town located in the oasis, the capital of New Valley Governorate. The oasis, which was known as the 'Southern Oasis' to the Ancient Egyptians, is the largest of the oases in the Libyan desert of Egypt. It is in a depression about 160 km (100 miles) long and from 20 km (12 miles) to 80 km (50 miles) wide. Its **population is 67,700 (2012)**

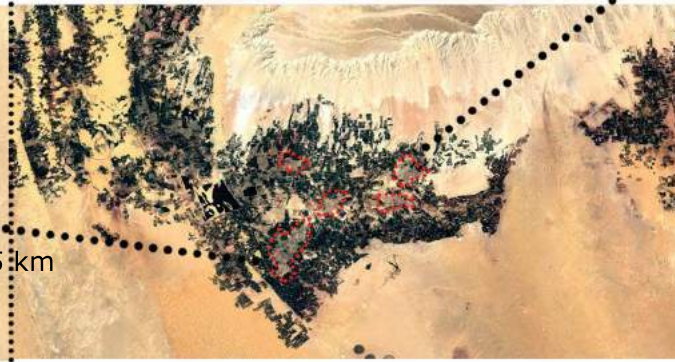

### Dakhla Oasis

It measures approximately 80 km (50 mi) from east to west and 25 km (16 mi) from north to south. It has **population about 75,000**. Dakhla Oasis consists of several communities, along a string of sub-oases. The main settlements are Mut (more fully Mut el-Kharab and anciently called Mothis), El-Masara, Al-Qasr, Qalamoun, together with several smaller villages. Some of the communities have identities that are separate from each other. Qalamoun has inhabitants that trace their origins to the Ottomans.



- ★ National capital
- ⊙ Governorate capital
- Town, village
- ✈ Major airport
- Cistern, spring, well
- International boundary
- - - Governorate boundary
- == Dual highway
- Main road
- - - Secondary road
- - - Track
- +— Railroad

## 1 week desert tour

Cairo \_\_\_\_\_ Al Bawiti(Bahariya Oasis) \_\_\_\_\_ **Siwa** \_\_\_\_\_ Sid Barani \_\_\_\_\_ Al Alemein \_\_\_\_\_ Alexandria



## 5 day desert tour

Cairo \_\_\_\_\_ Al Bawiti(Bahariya Oasis) \_\_\_\_\_ **Siwa** \_\_\_\_\_ Great sand sea \_\_\_\_\_ white desert



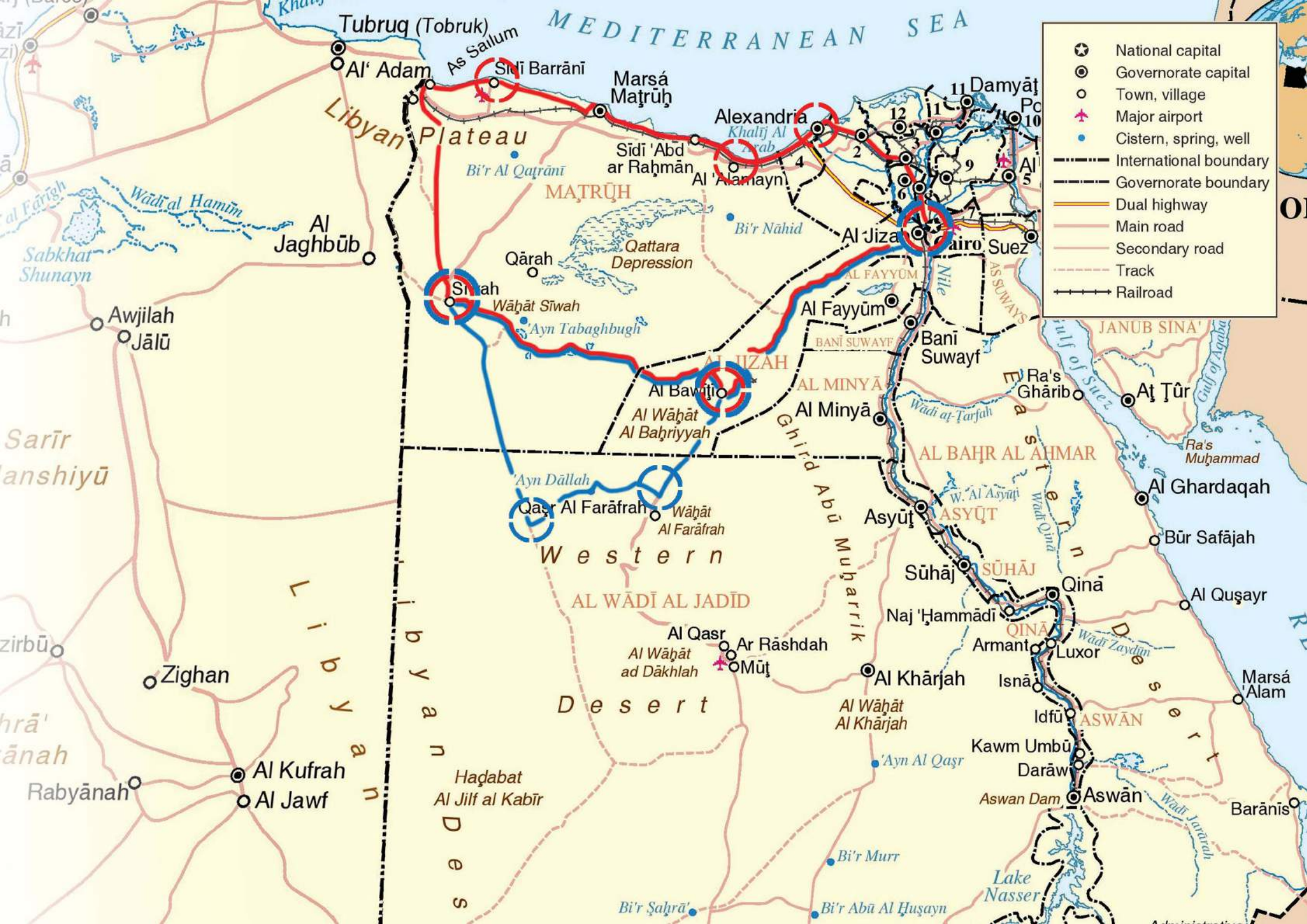

- ★ National capital
- ⊙ Governorate capital
- Town, village
- ✈ Major airport
- Cistern, spring, well
- International boundary
- - - Governorate boundary
- == Dual highway
- Main road
- - - Secondary road
- - - Track
- +— Railroad

Tubruq (Tobruk)

MEDITERRANEAN SEA

Libyan Plateau

MAṬRŪḤ

Alexandria

Damyāt

Al Jaghbūb

Qārah

Al Jiza

Cairo

Suez

Awjilah  
Jālū

Siwah  
Wāḥāt Siwah

Al Fayyūm

Banī Suwayf

Sarīr  
anshiyū

AL IJZAH

AL MINYĀ

Banī Suwayf

JANUB SINĀ'

Al Bawrijīo  
Al Wāḥāt  
Al Bahriyyah

AL MINYĀ

Banī Suwayf

Ra's Ghāribō

Western

AL WĀDĪ AL JADĪD

AL BAḤR AL AḤMAR

Al Ghardaqaḥ

Ayn Dāllah  
Qaṣr Al Farāfrāh

Wāḥāt  
Al Farāfrāh

Asyūṭ

Sūḥāj

Al Ghardaqaḥ

zīrbū

Zighan

AL WĀDĪ AL JADĪD

Asyūṭ

Sūḥāj

Al Ghardaqaḥ

hrā'  
ānah

Rabyānah

Al Kufrah  
Al Jawf

Al Qaṣr  
Al Wāḥāt  
ad Dākhlah

Ar Rāshdah  
Mūṭ

Al Khārjah

Naj 'Hammādī

Al Ghardaqaḥ

Haḡabat  
Al Jilf al Kabīr

Al Khārjah

Al Khārjah

Al Ghardaqaḥ

Idfū

Al Ghardaqaḥ

Idfū

Al Ghardaqaḥ

Aswān

Al Ghardaqaḥ

Barānis

Bi'r Ṣaḡrā'

Bi'r Murr

Bi'r Abū Al Ḥuṣayn

Aswān

Al Ghardaqaḥ

Aswān

Al Ghardaqaḥ

Al Ghardaqaḥ





03

# DESERTIFICATION

SOURCE: Food and agriculture organization  
[http://www.fao.org/docrep/v0265e/V0265E01.htm#Definition and general approach to the problem](http://www.fao.org/docrep/v0265e/V0265E01.htm#Definition%20and%20general%20approach%20to%20the%20problem)  
Sustainable development of drylands and combating desertification.

## General approach

*"The sum of the geological, climatic, biological and human factors which lead to the degradation of the physical, chemical and biological potential of lands in arid and semi-arid zones, and endanger biodiversity and the survival of human communities."*

This definition is close to approved by the 1977 UN Conference on Desertification, in Nairobi:

*"... intensification or extension of characteristic desert conditions; the process entails a reduction in biological activity and plant biomass, in livestock-carrying potential of land, in agricultural yields and a decline or degradation in man's living conditions."*

### desertification risk

assessed by measuring land vulnerability in combination with current and future demographic and agricultural pressures. To use such criteria means considering desertification processes as evolving according to changing human and climatic factors. As a consequence, each country needs to have ways of analysing these processes on the basis of globally accepted criteria

### main causes

desertification as previously defined can only occur on land prone to desertification processes. The vulnerability to desertification of land is determined by current **climate, relief, and the state of the soil and vegetation**. Climate has a major influence through three factors **rainfall, solar radiation** and **wind**, which all affect physical and mechanical erosion phenomena and chemical and biological degradation.

**Relief** acts mainly to exacerbate water erosion. **The state of the soil**, in terms of its texture, structure and chemical and biological status, is a predominant factor in dry subhumid zones, where climate has less impact; it plays a crucial role in vulnerability to desertification through human activities. The same applies to the state of the **natural vegetation**. Because of their longevity and powerful root systems, trees are a primary source of protection from soil degradation and their absence, too often caused by human action.

*Human activities are the main factors triggering desertification processes on vulnerable land. These activities are many and vary by country, society, land-use strategies and the technologies applied.*

cultivation of soils that are fragile, or exposed to erosion by wind or water;  
reduction in the fallow period of soils, and lack of organic or mineral fertilizers;  
overgrazing - often selectively - of shrubs, herbs and grasses;  
overexploitation of woody resources, in particular for fuelwood;  
uncontrolled use of fire for regenerating pasture, for hunting, for agricultural clearing, or for settling certain social conflicts;  
agricultural practices that destroy the soil structure, especially the use of unsuitable agricultural machinery;  
agricultural practices that result in the net export of soil nutrients, leading to loss of the soil fertility, such as cash-cropping;  
diversion of rivers to create irrigation schemes;  
irrigation of soils prone to salinization, alkalinization or even waterlogging

### consequences

The consequences of desertification - the phenomenon of land degradation - depend on four factors that vary by region, country and year:

the seriousness and extent of land degradation;  
the severity of climatic conditions at the time (especially annual rainfall);  
the number and diversity of affected populations; and  
the level of development of the country involved.

Desertification should be viewed as a breakdown of the fragile balance that allowed plant, human and animal life to develop in arid, semi-arid and dry subhumid zones.

This breakdown of the equilibrium and of the physical, chemical and biological processes that sustain it, represents the start of a process of self-destruction for all elements of the life system. Thus soil vulnerability to wind and water erosion, the lowering of the water-table, the impairment of the natural regeneration of vegetation, the chemical degeneration of soils - themselves all immediate results of desertification - worsen the situation. Desertification feeds on itself.

*Forced to attend to the most urgent things first, populations resort to survival strategies that unfortunately make desertification worse and prevent any development.*

The most immediate and generally widespread of these survival strategies is to intensify over-exploitation of the most readily available natural resources, but at the cost of enormous effort. The second strategy is to sell off everything owned, including agricultural equipment, to cope with the monetary needs of development (e.g. schooling, social services, contributions to pump maintenance), or food crises (buying food). The third strategy is increasing rural migration: this may simply involve men and young people leaving for a seasonal or longer-term job in other areas of the country, particularly the towns, or going to other countries; or the migration may take on the proportions of a population exodus in search of better living conditions.

Micro-projects undertaken in many places over the last 15 years have resulted in a wealth of knowledge and some practical techniques. *Belonging to the rural peoples, whose wish to appropriate land and organize themselves into groups, cooperatives, village development associations, autonomous local associations, etc., is evolving and augurs well for the future.*

# Desertification Vulnerability

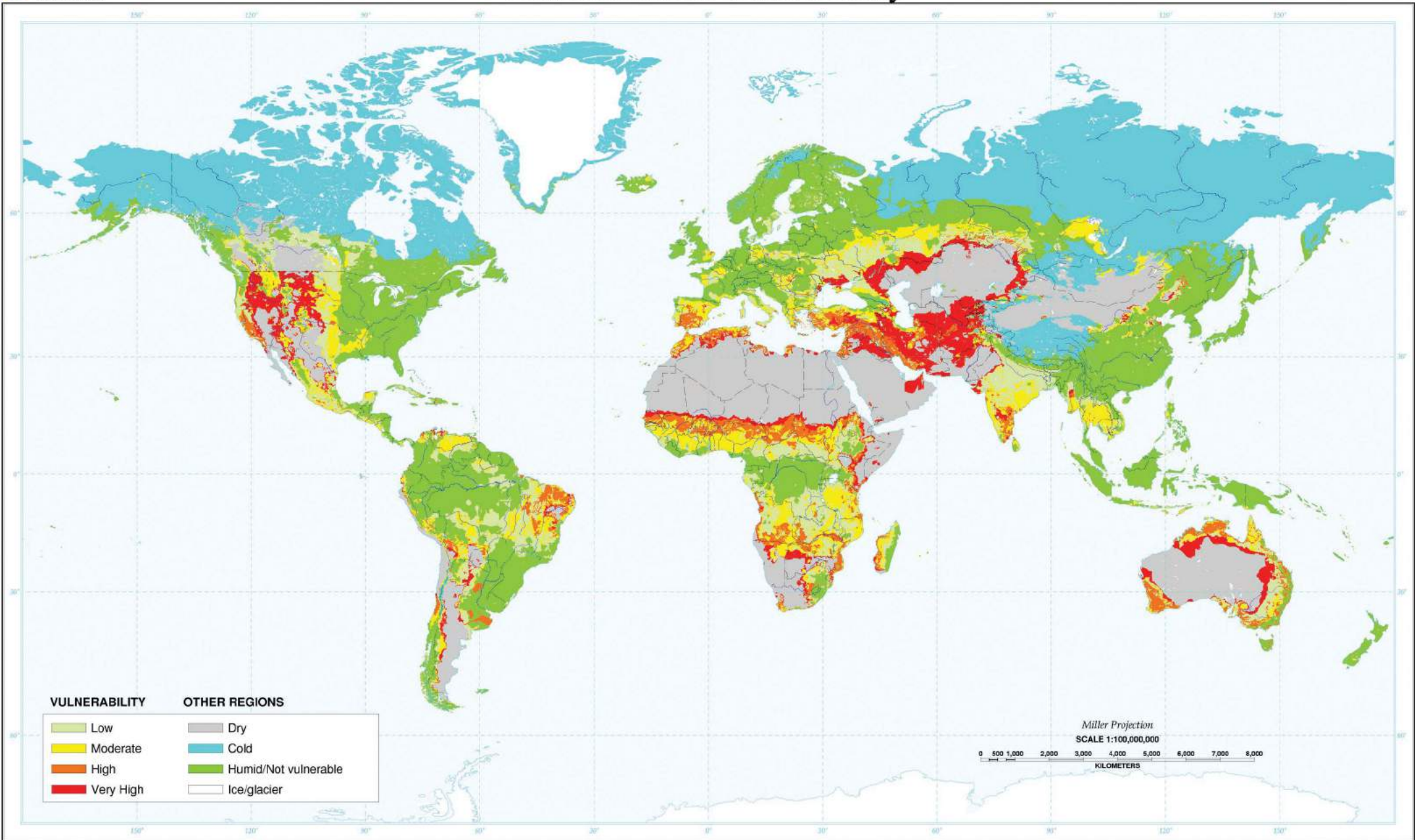

# DESERTIFICATION

SOURCE: United Nations

<http://www.unccd.int/Lists/SiteDocumentLibrary/Publications/Desertification-EN.pdf>

Convention for combating desertification

## Strategy for combating

Best Practice approaches focus on:

- Sustainable Land Management (SLM) technologies, including adaptation;
- capacity-building and awareness-raising at various levels;
- desertification, land degradation and drought, and SLM monitoring and assessment/research;
- knowledge management and decision support;
- the policy, legislative and institutional framework;
- funding and resource mobilization; and
- participation, collaboration and networking.

### increase Population resilience

Preventing land degradation is obviously essential where it is possible, and where it is not recovery and rehabilitation are good options. Mainstreaming sustainable land management, drought-risk management and biodiversity considerations into the design, implementation and monitoring of adaptation action at local, national and regional levels is clearly central to any attempt to slow the progress of desertification.

Supporting science-driven agriculture is clearly essential, as it is the way to enable farmers to take advantage of up-to-date developments and best practice which has worked elsewhere. Rainwater harvesting, drought-resistant crop varieties, agro-forestry and efficient energy use will all contribute to sustainable land management and improved ways of managing drought risk.

Further, it is well established that the dry areas and threatened areas are overpopulated, therefore unable to support human and livestock populations. One of the main keys is to reduce the dependence on these lands via creating jobs in other sectors not based on cultivation, or on range or forest lands.

### Improve Land management

To combat desertification it is necessary to restore and fertilize the land. Nutrients such as nitrogen, phosphorus, calcium, magnesium etc. must be in the soil for plants to grow.

*Intensive agriculture is one of the main reasons for the soil to degrade, and once that has happened it is necessary to re-establish soil fertility by using either synthetic fertilizers or natural compost.*

There is also a cultural aspect linked to land management and the challenge of overgrazing. It can be hard to convince local farmers to adopt the ideas of giving land time to recover and reducing herd numbers. In many countries the amount of livestock is a source of pride and honour for the owner, their family or clan.

### Diversify production

Diversifying crop and animal production allows better use of land resources and prevents over-production of a single species or crop. A plot can sustain different plants and animals over long periods, since their nutritional needs vary and the resources they remove from the land are complementary.

### Restore land

Land degradation need not be permanent. To restore degraded lands, crop techniques should be improved by stabilizing the soil while enriching it with organic matter, and selecting different crop varieties. Even the slightest water levels can be used to irrigate and make unproductive soil productive. It is also important to combat marked soil salinity by employing the most effective system of irrigation.

Experience shows that reforestation is a very effective approach to restoring land. It requires the creation of nurseries to nurture young plants from local species selected for their rapid growth and adaptation to the harsh climate. In rangelands, rehabilitation through shrub planting or seeding of appropriate species is also an effective means of land restoration.

### Trees play several roles:

- they fix soil particles and prevent erosion by water and wind;
- act as obstacles to the wind and so protect crops;
- enhance soil fertility since many trees produce nitrogen that fertilizes and increases soil productivity;
- facilitate water penetration in the soil during rain and contribute to maintaining humidity for long periods;
- provide shade for animals and people;
- supply nutrients because fruit trees diversify food sources and provide fodder for livestock
- provide a source of firewood and construction materials.

### Control Erosion

To prevent desertification or to restore the productivity of damaged soil, erosion control is essential. A number of simple mechanical means alleviate the effects of wind and prevent the displacement of sand and dust. These include:

- the construction of fences or barriers from local plant species, woven palms, planted hedges or metal sheeting around villages and crops;
- planting vegetation whose roots protect and fix the soil;
- prohibiting livestock from grazing to protect the plantation areas.

### USE Non-wood energy sources

All human societies use energy, which is vital for their proper functioning and development. Today, a large number of populations use wood as their major source of energy, which contributes to worsening desertification through deforestation and also increases the greenhouse effect by releasing carbon dioxide.

### Solar energy

Given the right technology, the bright, sunny conditions characteristic of arid and semi-arid regions, can satisfy energy needs in these areas.

Ideally solar energy would be the obvious choice, and could be used in many ways, for instance:

- greenhouses integrated into the dwelling structure with panels that store energy from the sun in batteries (to supply hot water);
- parabolic mirrors to help cook food and produce steam for running steam turbines;
- photo-voltaic panels to transform the sun's rays into electricity. The electric current is stored in batteries and can be used day or night; and
- the evaporation power of the sun can produce distilled, salt-free water by means of a solar distiller.

## Wind

Wind turbines need to be set on open exposed areas with high average wind speeds (at least 20 km/h). However, wind energy is growing rapidly because it can provide more energy on a large scale than solar power. In drylands with frequent winds, this form of energy could be an important complement in the long term. For example, wind energy can facilitate irrigation and water supplies for livestock.

One of the greatest advantages of wind energy is that it is plentiful. It is also widely distributed, cheap, does not emit toxic gases, and avoids uncontrolled tree-felling or fuelwood collection.

## Biogas

Natural gas and biogas are in essence the same fuel but from different origins. While natural gas is a fossil fuel, biogas is a renewable fuel produced through the fermentation of organic materials such as household or agricultural waste. The high temperatures in the drylands are beneficial to biogas creation. Biogas has several advantages. For one thing it is cheap to produce and can be used for lighting, cooking or to drive motors. It can also be produced in small installations, especially in regions where agriculture and cattle rearing coexist. In developing countries, over 500 million households still use traditional biomass for cooking and heating.

Elsewhere 25 million households already cook and light their homes with biogas and a growing number of small industries, including agricultural processing, obtain process heat and motive power from small-scale biogas digesters. Biogas is an example of a stationary use application thought to have particularly good potential as a renewable energy source with good greenhouse gas savings, especially when waste is used. Nevertheless, when energy crops are used for biogas, ecological and land use concerns need to be considered.

## Find alternative solutions biochar

Land has an unparalleled capacity to hold carbon and to act as a sink for greenhouse gases. It is therefore imperative to focus on activities that enhance the rehabilitation, protection and sustainable management of degraded lands. Conventional means to increase soil carbon stocks depend on climate, soil type and site-specific management.

Biochar is charcoal created by a process called biomass pyrolysis (the decomposition or transformation of a compound by heat), and differs from charcoal only in that its primary use is not for fuel but for but for improving agricultural soils. Biochar was added to soils in the Amazon basin several hundred years ago with the affect of improving agricultural production.

Biochar is of increasing interest because of concerns about climate change caused by carbon dioxide and other greenhouse gas emissions. The pyrolysis or carbonization process is well known and can be implemented on a small scale (a cooking stove) as well as on a large scale (e.g. a biorefinery). About 50 per cent of the carbon can be captured when biomass is converted to biochar.

Some types of biochar can improve soil texture, thereby increasing its ability to bind and retain fertilizers and release them gradually. It naturally contains many micronutrients needed by plants and is safer than other "natural" fertilizers such as manure or sewage, having undergone high-temperature disinfection. Because it releases nutrients slowly, it poses much less risk of water table contaminations.

## Zero-tillage farming

Zero-tillage farming (also called no-till or no-tillage) is a method of plowing or tilling a field in which the soil is disturbed as little as possible by, essentially, not plowing the field. The crop is planted directly into a seedbed which has not been tilled since the harvest of the previous crop. This way farmers can increase the amount of water in the soil and decrease erosion. It may also increase the amount and variety of life in and on the soil, but may require increased herbicide usage. Zero-tillage also improves the structure of the soil by maintaining soil cover. It implies leaving the residues of the previous season's crops on the farmland, which can increase water infiltration while reducing evaporation as well as wind and water erosion.

- Conservation of soil moisture;
- Reduction of soil erosion by the wind since the crop residue cover isn't plowed under the soil;
- Reduction of farm labour (i.e. time actually spent tilling the field, fuel consumption) thereby reducing farm expenses;
- Increased planting and harvesting timelines, since time spent tilling and preparing the field required;
- Earthworms, and other biological organisms, are left alone to live and manipulate the soil by creating tunnels, which otherwise would be created by tilling. This allows for good movement of water and air throughout the soil for good plant growth;
- Reduced soil compaction. Many years of tilling lead to a very hard, densely packed soil; and
- Increased soil organic means better soil structure and more available nutrients for plant growth. Tilling 'burns' organic matter away. Increasing soil organic helps to sequester the soil.

# DESERTIFICATION

SOURCE: United Nations  
<http://www.unccd.int/Lists/SiteDocumentLibrary/Publications/Desertification-EN.pdf>  
 Convention for combating desertification

## in context

Best Practice approaches focus on:

- Sustainable Land Management (SLM) technologies, including adaptation;
- capacity-building and awareness-raising at various levels;
- desertification, land degradation and drought, and SLM monitoring and assessment/research;
- knowledge management and decision support;
- the policy, legislative and institutional framework;
- funding and resource mobilization; and
- participation, collaboration and networking.

## Climate Change

Desertification is exacerbated by climate change and vice versa. As severe weather events increase in frequency and severity due to climate change, dryland degradation tends to increase. Worse still, desertification and climate can form a 'feedback loop' with the loss of vegetation caused by desertification reducing carbon sinks and increasing emissions from rotting plants. The result is more greenhouse gases in the atmosphere, and a continuation of the vicious cycle involving climate change and desertification. In Africa alone, a total of more than 650 million people are dependent on rain-fed agriculture in environments that are already affected by water scarcity and land degradation, which will be further exacerbated by climate change.

While soil degradation emits greenhouse gases, soil restoration prevents such emissions and even creates storage capacities for greenhouse gases already in the atmosphere. Carbon sequestration is the process by which carbon sinks (both natural and artificial) remove CO2 from the atmosphere, primarily as plant organic matter in soils. Organically managed soils can convert CO2 from a greenhouse gas into a food-producing asset.

## Water scarcity

Water availability affects domestic life as well as the development of certain agricultural techniques. In drylands more than anywhere else, water availability is often critical. These areas are characterized by a high evaporation rate and surface waters such as rivers and lakes tend to disappear relatively quickly.

While irrigation could improve food production, its inefficient application can also be a risk, especially in terms of salinization. For example, about 10 per cent of the world's irrigated land has been damaged by salt, compounding the threats to food security. Salinization is reducing the world's irrigated area by 1-2 per cent every year (FAO 2002).

## Water

Number of people without access to improved drinking water

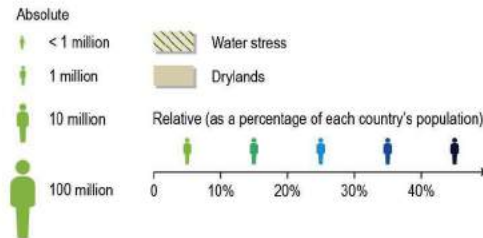

**Definition of water stress:**  
 Domestic, Industrial and Agricultural water demand per available water supply per grid cell along river network. This indicator is also known as Relative Water Demand (RWD).  
 (→ [www.unesco.org/water/wwap/wwdr/indicators](http://www.unesco.org/water/wwap/wwdr/indicators))

Land degradation in the drylands can have direct consequences on the water cycle. If there is low rainfall, drought ensues: groundwater reserves do not refill, water sources become depleted, wells run dry, plants and animals die and humans have to migrate to more hospitable regions. Conversely, during periods of high rainfall, the ensuing floods kill people and animals, notably in regions where the vegetation cover is reduced or totally destroyed. The torrential rainfall causes a substantial loss of soil, which is flushed out by the rains and when the land dries again, a hard crust forms on the surface making it impermeable, and reducing water infiltration.

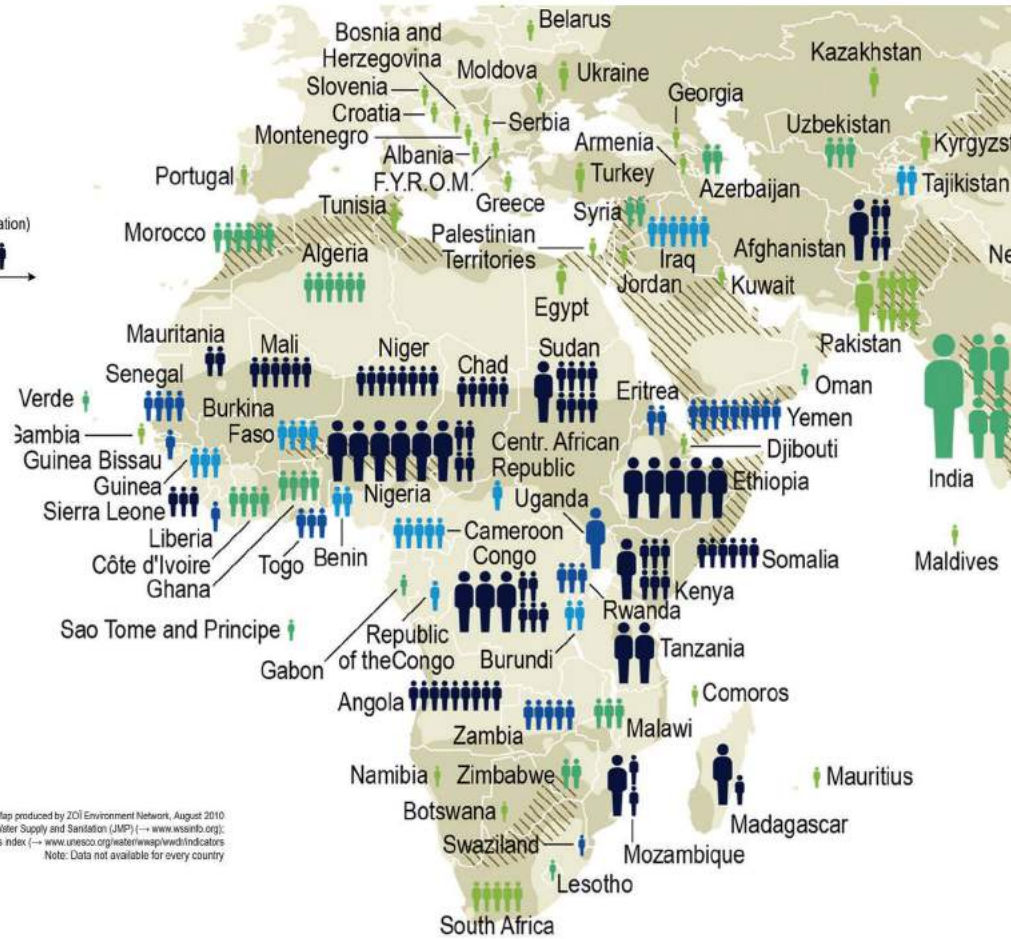

Map produced by ZOI Environment Network, August 2010  
 Source: WHO / UNICEF - Joint Monitoring Programme for Water Supply and Sanitation (JMPS) (→ [www.wssinfo.org/](http://www.wssinfo.org/));  
 UNESCO - World Water Development Report Indicators, water stress index (→ [www.unesco.org/water/wwap/wwdr/indicators](http://www.unesco.org/water/wwap/wwdr/indicators))  
 Note: Data not available for every country

## Environmental Migration

Desertification is a global issue, which threatens development, sparking an exodus from the affected regions because when land becomes uneconomic to farm, people are often forced into internal or cross-border migration. This can further strain the environment and cause social and political tensions and conflicts.

In some countries, land degradation has led to massive internal migrations, forcing whole villages to flee their farms for already overcrowded cities. Fifty million people are at risk of displacement in the next ten years if desertification is not checked (UNU 2007).

Problems occur in the urban environment as well as in rural areas still unaffected by land degradation, but which receive new migrants. Desertification can drive whole communities to migrate towards cities or regions where survival conditions are initially more promising but grow increasingly difficult and threaten social stability and cultural identities. The makeshift dwellings, which are insanitary and illegal, are sometimes sources of ethnic or religious conflict. Desertification also causes political instability and has played a part in sparking off some of the armed conflicts currently underway in the drylands.

## Loss of Biodiversity

Drylands are often seen as being devoid of life, but in fact they contain an incredible diversity of species that are well adapted to the difficult climatic conditions. The biodiversity we see today is the result of thousands of millions of years of evolution, shaped by natural processes and, increasingly, the influence of humans.

Biodiversity underpins many livelihoods in drylands, including pastoralism, agriculture and tourism. Nature-based tourism is a particularly important source of income for people living in sub-Saharan Africa where community management of biodiversity yields positive benefits both for biodiversity conservation and sustainable use, as well as for sustainable livelihoods.

As a consequence of land degradation, animal species that are dependent on vegetation have to migrate to other areas to find sufficient resources or they risk disappearing altogether. Their loss is significant because animal and plant species from the drylands are particularly well adapted to this extreme environment. They act as indicators of environmental conditions and their disappearance is a sign of significant habitat degradation.

Taking all these factors into account, desertification reduces the natural capital available to drylands species and people, making them more vulnerable to change. The loss of dryland biodiversity also limits the extent to which drylands can recover from temporary reductions in productivity.

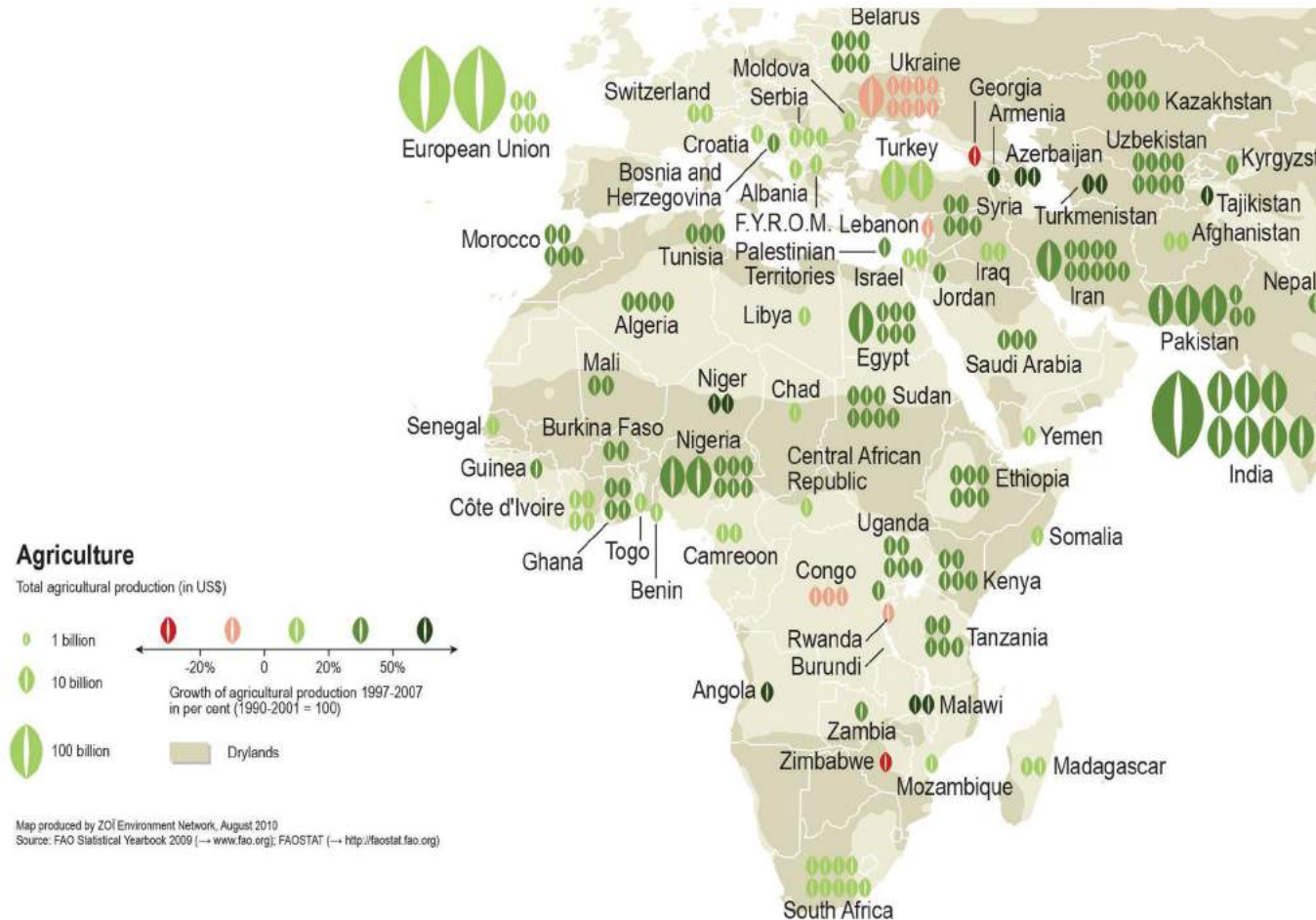

# DESERTIFICATION

SOURCE: United Nations  
<http://www.unccd.int/Lists/SiteDocumentLibrary/Publications/Desertification-EN.pdf>  
Convention for combating desertification

## in context

### Deforestation

Deforestation and desertification adversely affect agricultural productivity, the health of humans as well as of livestock, and economic activities such as ecotourism. Forests and tree cover combat land degradation and desertification by stabilizing soils, reducing water and wind erosion and maintaining nutrient cycling in soils. The sustainable use of goods and services from forest ecosystems and the development of agroforestry systems can, therefore, contribute to poverty reduction, making the rural poor less vulnerable to the impacts of land degradation.

A key factor on how deforestation triggers desertification is linked to a drastic change in microclimates where vegetation is removed. For instance, if shrubs and trees are felled, the noonday sun will fall directly on formerly shaded soil;

The problem of developing arid lands and improving the well-being of the people dependent on them, is vast and complex. Forestry has a major role to play in any strategy to tackle it:

- it plays a fundamental role in the maintenance of the soil and water base for food production through shelterbelts, windbreaks, and scattered trees, and soil enrichment;
- contributes to livestock production through forest pastoral systems, particularly by the creation of fodder reserves or banks in the form of fodder trees or shrubs to cushion droughts;
- produces fuelwood, charcoal, and other forest products through village and farm woodlots;
- contributes to rural employment and development through cottage industries based on raw materials derived from wild plants and animals and the development of wildlife-based tourism;
- provides food from wildlife as well as from plants in the form of fruits, leaves, roots, and fungi.

### Poverty Eradication

The majority of people who are directly affected by desertification live below poverty line and without adequate access to fresh water. Poverty drives populations to over-exploit the remaining natural resources, triggering a vicious cycle of accelerating land degradation and greater poverty. Poverty is thus both a cause and a consequence of desertification.

The occurrence of desertification and prolonged drought reduces national food production and increases the need to turn to foreign products. Moreover, food aid can eventually lead to a reduction in local agricultural production, especially if it becomes more costly to produce locally than to resort to imports that

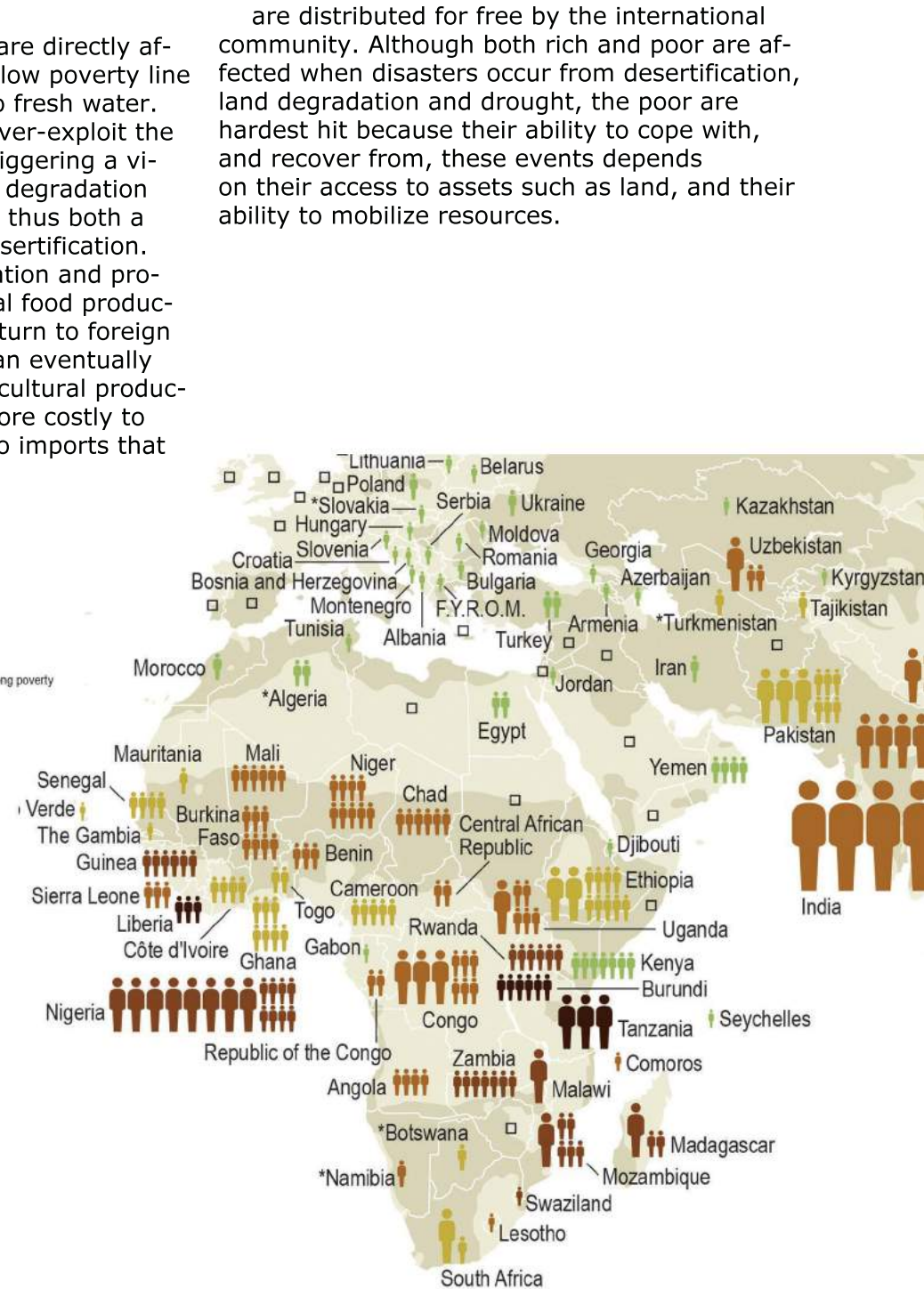
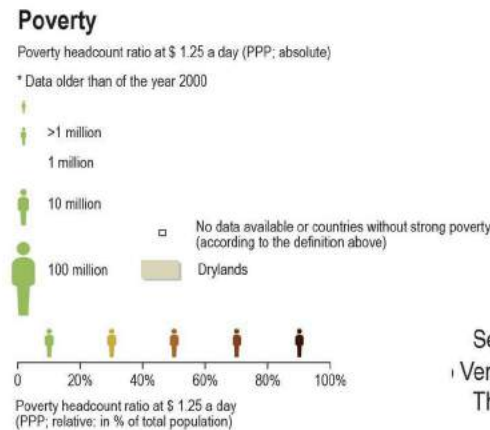

are distributed for free by the international community. Although both rich and poor are affected when disasters occur from desertification, land degradation and drought, the poor are hardest hit because their ability to cope with, and recover from, these events depends on their access to assets such as land, and their ability to mobilize resources.



### Food security

One of the reasons why desertification is considered a major global environmental issue is the link between dryland degradation and food production. Meeting the food demand for the projected population increase by 2050 (which will be mostly urban and richer) will be difficult to achieve even under favourable circumstances. If desertification is not stopped and reversed, food yields in many affected areas will decline. Malnutrition, starvation, and ultimately famine may result. Meeting global food targets and sustaining a breakthrough in terms of yield will require more land and therefore more water, or at least more production per unit area or volume of water.

Farmers will need to adapt, possibly by using new technologies and crops to be more frugal in their water use. A movement towards an increased utilization of drought- and heat-tolerant crops could be extremely important. Food security can ultimately be put at risk when people already living precariously face severe droughts and other environmental disasters. Famine typically occurs in areas that also suffer from poverty, civil unrest, or war. Drought and land degradation often help to trigger a crisis, which is then made worse by poor food distribution and inability to buy what is available.

### Loss of Biodiversity

Drylands are often seen as being devoid of life, but in fact they contain an incredible diversity of species that are well adapted to the difficult climatic conditions. The biodiversity we see today is the result of thousands of millions of years of evolution, shaped by natural processes and, increasingly, the influence of humans.

Biodiversity underpins many livelihoods in drylands, including pastoralism, agriculture and tourism. Nature-based tourism is a particularly important source of income for people living in sub-Saharan Africa where community management of biodiversity yields positive benefits both for biodiversity conservation and sustainable use, as well as for sustainable livelihoods.

As a consequence of land degradation, animal species that are dependent on vegetation have to migrate to other areas to find sufficient resources or they risk disappearing altogether. Their loss is significant because animal and plant species from the drylands are particularly well adapted to this extreme environment. They act as indicators of environmental conditions and their disappearance is a sign of significant habitat degradation.

Taking all these factors into account, desertification reduces the natural capital available to drylands species and people, making them more vulnerable to change. The loss of dryland biodiversity also limits the extent to which drylands can recover from temporary reductions in productivity.

### Food insecurity

Number of people undernourished 2004 - 2006  
 Note: data not available for every country

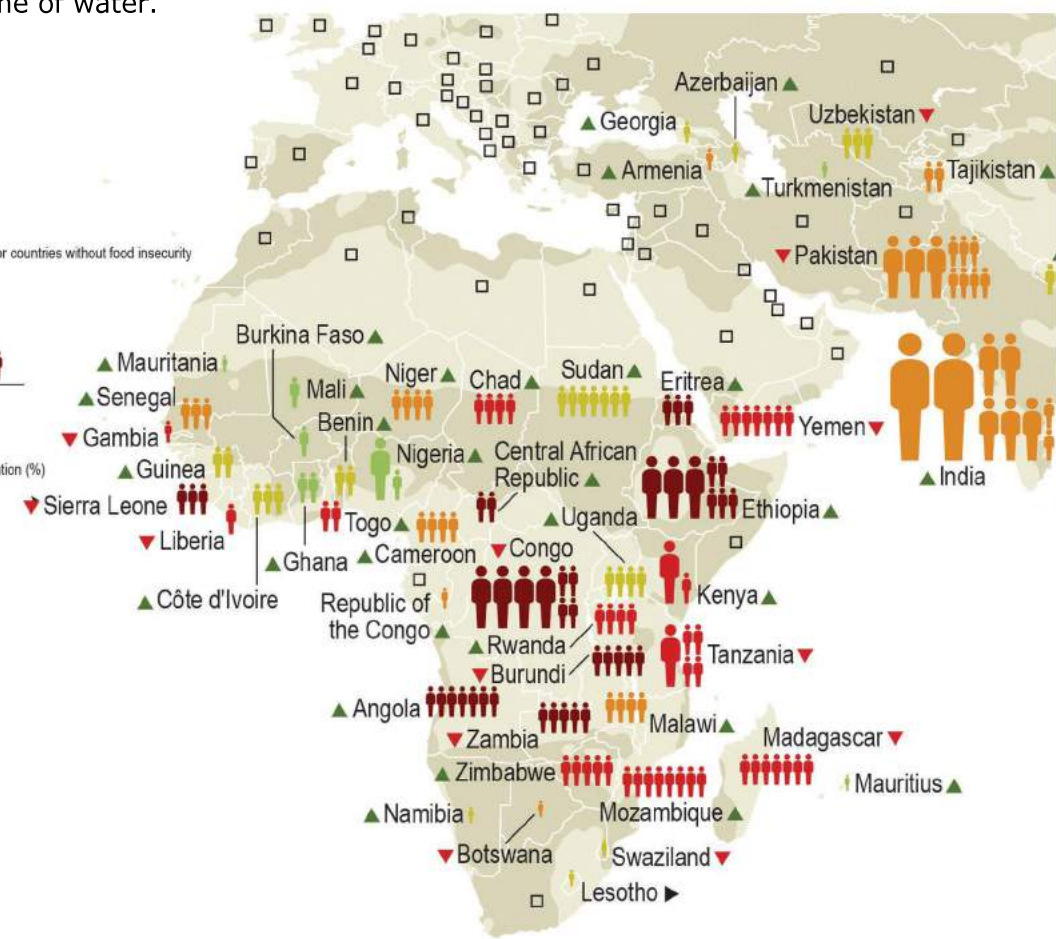
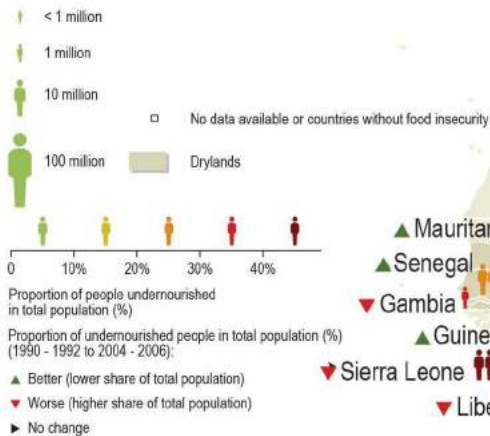

# DESERTIFICATION

SOURCE: Food and agriculture organization

[http://www.fao.org/docrep/v0265e/v0265E01.htm#Definition and general approach to the problem](http://www.fao.org/docrep/v0265e/v0265E01.htm#Definition%20and%20general%20approach%20to%20the%20problem)

Sustainable development of drylands and combating desertification.

## Strategy for combating

*"Human beings are at the heart of the desertification problem, either as actors or victims. The fight against desertification is a fight for survival."*

### Guiding principles

*The principle of integration* aims primarily at integrating the immediate, medium- and long-term needs of the population. The immediate needs are food, health, education and financial income while the medium- and long-term needs include the defence, rehabilitation and management of available natural resources. Satisfying immediate needs will be risky and provisional if land resources are not improved and rehabilitated; land and resource management will be hampered if immediate needs are unfulfilled

*The consultation principle* is based on people's participation, even more so than the integration principle.

*The principle of planned spatial approach* is fundamental to securing coherent action. To imagine regional and national development as an extension of local land management would be dangerous, for three main reasons.

It is not possible to operate effectively in all land areas at the same time, and thus it is necessary to proceed stage by stage.

Each community is itself part of a much larger whole. Therefore the community should maintain relations with other communities through regional and national organizations that support development in a certain technical, social and economic environment.

The need to act within the regional framework of the test area is also justified in order to reduce development gaps between the test and other areas by the latter being enabled to apply the lessons of the test area. Therefore the global approach is also practiced in a second spatial setting, that of the region where the test area is located

*The principle of decentralization* of decision-making and modalities of action is essential to success. The global and participatory approach should be implemented within an organizational framework of integration, consultation, planning, management and action. This framework ensures essential analytical and conceptual functions, but more specifically training, coordination and implementation of methods and action. The basic organizational unit is the village or community. At the regional level, the global approach programme has two interdependent functions: a technical and management function and a consultative and decision-making function. These two decentralized functions should be linked to a national organization.

*the principle of duration and flexibility of assistance to activities* is obvious in rural development and desertification control. The duration requirement means that governments and donors need to affirm their support on a long-term basis and implement it in financial phases that match national planning cycles if they exist.

### Strategic objectives

Strategic objective of combating desertification, the sustainable development of arid, semi-arid and dry subhumid zones must confront three challenges:

**using preventive measures, to check or prevent desertification of land slightly or not yet degraded**

**to regenerate, through corrective measures, the productivity of moderately degraded land**

**to restore the productivity of seriously degraded land, using rehabilitation and repair measures.**

The April 1991 FAO/Netherlands Conference on Agriculture and Environment took this position and concluded that rural sustainable development policies should aim at operating so that agricultural and rural sectors:

meet the basic nutritional needs of present and future generations;

supply rural people with long-term employment, adequate income and decent living and working conditions;

maintain, if necessary after rehabilitation, the productive capacity of natural resources; and mitigate the agricultural sector's vulnerability to hostile natural and socio-economic factors and other hazards.

**There are two main strategic components of action for the sustainable development of arid areas:**

International components  
**the international community should supply the financial and technical aid necessary to help poor developing countries**

National components  
**policies for developing rural service centres should be undertaken so that rural people have available:**

facilities for transport, storage and marketing of agricultural products;

access to supply sources for seeds, pesticides, medicines, etc.;

access to rural credit;

access to technologies adapted to the needs of preserving and rehabilitating land productivity and the diversification of plant and animal production;

facilities for developing craft industries and appropriate micro-industries, particularly by allowing access to renewable energy sources;

**land management and planning policies should be implemented so as to develop global outlines, incorporating vulnerability and risk as essential components of planning decisions;**

**policies of agricultural diversification and development of different activities, sources of income and food, such as fisheries and aquaculture, apiculture and processing of forestry products, should be pursued thoroughly.**

### **Operational implementation**

The territorial approach (the living area of a rural community being identified - but not exclusively - with a village's land) is important in sustainable development and in combating desertification. It offers a geographical setting where the dynamic relationships between local desertification factors can be faced in a coordinated and programmed way. This framework may be split into micro-catchment or cropping areas, providing a small but nevertheless significant sample that could be used as a starting-point for work on a total-territory basis. Conversely, this framework may be expanded to incorporate the physical, particularly hydrographic, factors at work on the lands of several communities. The territorial

approach also supplies a socio-economic setting, that of the community with knowledge and authority over its land. It is within this socio-economic setting, often steeped in cultural values, that the community can be organized and can defend and manage the rehabilitation of the productive natural resources of its land. This setting also makes it easier to understand the place and role of the community's various components, especially women and children, and to support their promotion and needs.

Having recognized that rural communities have the capacity to organize the sustainable management of their own territory, this should be supported, and neither denied nor diverted by development projects and services. Such assistance is needed to introduce

**March 1984 (dry)**



**September 1982 (wet)**





04

# GEOGRAPHY

## Egypt

**Official Name** | Arab Republic of Egypt

**Continent** | Africa

**Lat Long** | 25 00 N, 31 00 E

**Area** | 1 010 407 sq km

Water (%) - 0.632

**Population** | 92 741 000 2016 estimate

Density\_90/km2

**Capital** | Cairo

**Largest City** | Cairo

**Official Languages** | Arabic

**Major Religion** | Muslim (official; virtually all Sunni)

90 %, **Christian** (orthodox 9 % other christian 0,7%, Hindu <.1, Jewish <.1, folk religion <.1, unaffiliated 0.2%, other <.1)

**Form of Government** | Unitary semi-presidential republic

**President** | Abdel Fattah el-Sisi

**Prime Minister** | Sherif Ismail

**Currency** | Egyptian pound (EGP)

**GDP** | \$1,105 trillion 2016 estimate

Egypt located in northeastern Africa, with a small portion of its territory stretching across the Isthmus of Suez into southwestern Asia. Egypt has coastline along the Mediterranean Sea in the north, with the Gulf of Suez, the Gulf of Aqaba, and the Red Sea to the west. The extreme majority of the population lives in the region around the Nile River, its valley and delta, as much of the rest of the country contains sandy deserts. The Libyan Desert covers the west of Egypt, with the Eastern Desert from the Nile Valley to the coast. The Eastern Desert features mountains, including the Red Sea Hills. The Sinai Peninsula contains Egypt's highest point in its mountain ranges, at Mount Catherine, which stands 2,642 meters (8,668 feet) above sea level).

The Nile River has three sources. The Blue Nile comes from Ethiopia's Lake Tana and supplies the majority of the water to the Nile in Egypt. The White Nile flows from Uganda's Lake Victoria, through Juba in South Sudan and Khartoum in Sudan. The Atbara River is the shortest of the sources, flowing from Ethiopia to Khartoum and into Sudan.





**The Great Sand Sea** stretches for a length of about 650 km from north to south and a width of 300 km from east to west. On satellite images this desert shows a pattern of long sand ridges running in a roughly north-south direction. However, despite the apparent uniformity the Great Sand Sea has two large areas with different types of megadunes. The Egyptian sand sea lies parallel to the Calanshio Sand Sea of Libya, with which it is contiguous in the north. The dunes of the Great Sand Sea cover about 10% of the total area of the Egyptian Western Desert.

*Siwa* is an oasis located in Egypt, about 50 km (30 mi) east of the Libyan border, in the eastern part of the Great Sand Sea or Egyptian Sand Sea.



**White Desert** (known as Sahara el Beyda, with the word sahara meaning a desert) — a national park of Egypt and 45 km (28 mi) north of the town of *Farafra* (due to its geographical location and geological formation it has more than 100 wells spread out over the lands of the Farafra, many of which natural. Most of these wells are used in aggregation of the cultivated land in the oasis), the main draw of which is its rock type colored from snow-white to cream. It has massive chalk rock formations that are textbook examples of ventifact and which have been created as a result of occasional sandstorm in the area. The Farafra desert is a typical place visited by some schools in Egypt, as a location for camping trips

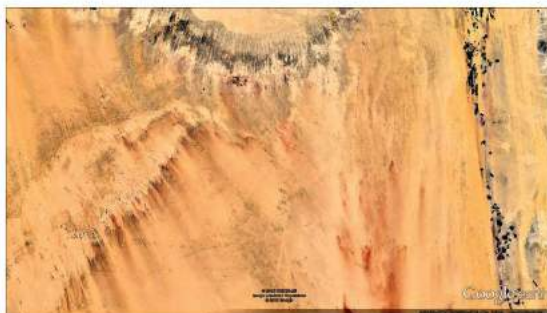

**The Western Desert of Egypt** is an area of the Sahara which lies west of the river Nile, up to the Libyan border, and south from the Mediterranean sea to the border with Sudan. The Western Desert is mostly rocky desert, though an area of sandy desert, known as **the Great Sand Sea**, lies to the west against the Libyan border. The desert covers an area of 262, 800 sq miles (680,650 km<sup>2</sup>) which is two-thirds of the land area of the country. Its highest elevation is 3,300 ft (1000m) in the **Gilf Kebir plateau** to the far south-west of the country, on the Egypt-Sudan-Libya border.

The area is also the location of a series of oases created where the land dips sufficiently to meet the aquifer. These lie in an arc from *Siwa* in the north-west near the Libyan border, to *Bahariya*, *Farafra*, *Dakhla*, then Kharga in the south. Further to the east, near the Nile, another depression gives rise to the *Fayyum Oasis*, a heavily populated area separate from the main Nile valley.

In the south-west, near the point where the borders of Libya, Sudan and Egypt meet, is an area of desert glass, thought to have been formed by a meteorite strike at Kebira, over the border in Libya.



**The Eastern Desert** is the section of Sahara Desert east of the Nile River, between the river and the Red Sea. it extends from Egypt in the north to Eritrea in the south, and also comprises parts of Sudan and Ethiopia.

The Eastern Desert's main geographic features are the western Red Sea coastline—with the "Red Sea Riviera"—and the Eastern Desert mountain range that runs along the coast, the highest peak of which is Shaiyb al-Banat (2,187 m). Other notable ecological areas are Wadi Gamal National Park and Gebel Elba. The Eastern Desert is a popular setting for safaris and other excursions.

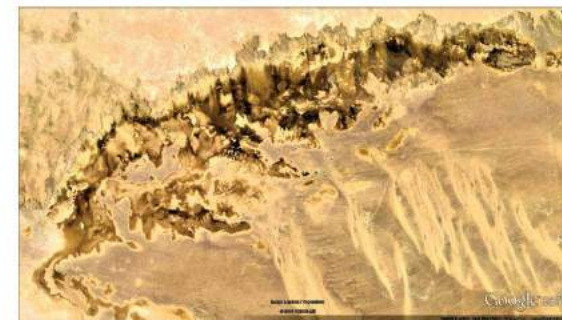

**Qattara Depression** - The region was created by the interplay of salt weathering and wind erosion. The Qattara Depression contains the second lowest point in Africa at -133 metres (-436 ft) below sea level, the lowest being Lake Assal in Djibouti. The depression covers about 19,605 square kilometres (7,570 sq mi), a size comparable to Lake Ontario. It has been studied for its potential to generate hydroelectricity. Within the Depression are salt marshes, under the northwestern and northern escarpment edges, and extensive dry lake beds that flood occasionally.

**Sinai peninsula desert** - The southern side of the peninsula has a sharp escarpment that subsides after a narrow coastal shelf that slopes into the Red Sea and the Gulf of Aqaba. The elevation of Sinai's southern rim is about 1,000 m. Moving northward, the elevation of this limestone plateau decreases. The northern third of Sinai is a flat, sandy coastal plain, which extends from the Suez Canal into the Gaza Strip and Israel. Similar to the desert, the peninsula contains mountains in its southern sector that are a geological extension of the Red Sea Hills, the low range along the Red Sea coast that includes Mount Catherine (Jabal Katrihah), the country's highest point, at 2,642 m.



# HYDROGEOLOGY

British geological survey

[http://earthwise.bgs.ac.uk/index.php/Hydrogeology\\_of\\_Algeria](http://earthwise.bgs.ac.uk/index.php/Hydrogeology_of_Algeria)

## Egypt

*Estimated population* in 2013 | **82,056,378**

*Rural population* (% of total) | **57.0%**

*Total surface area* | **995 450 sq km**

*Agricultural land* (% of total area) | **3.6%**

*Annual freshwater withdrawal* (2013) | **68,300 million m3**

*Annual freshwater withdrawal for agriculture* (2013) | **86.4%**

*Annual freshwater withdrawal for domestic use* (2013) | **7.8%**

*Annual freshwater withdrawal for industry* (2013) | **5.9%**

*Rural pop. with access to improved w. source* (2012) | **98.8%**

*Urban pop. with access to improved w. source* (2012) | **100%**

Source: World Bank

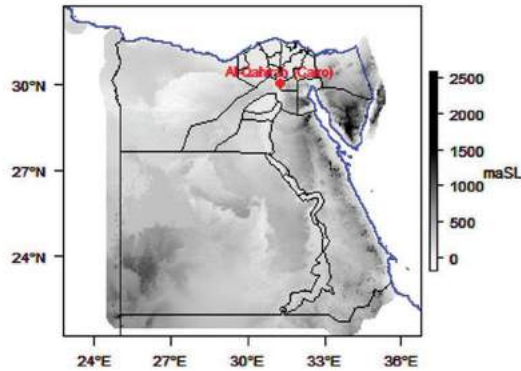

Egypt. Map developed from USGS GTOPOPO30; GADM global administrative areas; and UN Revision of World Urbanization Prospects.

### Climate

The prevailing wind to the Mediterranean Sea continuously blows over the northern coast without the interposition of an eventual mountain range and thus, greatly moderates temperatures throughout the year. Because of the

effect, average low wind[1] vary from 9.5 °C (49.1 °F) in wintertime to 23 °C (73.4 °F) in summertime and average high temperatures vary from 17 °C (62.6 °F) in wintertime to 32 °C (89.6 °F) in summertime. Though temperatures are moderated along the coasts, the situation changes in the interior of the country which are away from the moderating northerly winds. Thus, in the central and the southern parts, daytime temperatures are hotter, especially in summers where average high temperatures can exceed 40 °C (104 °F) in cities and places such as Aswan, Luxor, Asyut or Sohag which are located in the deserts of Egypt. Some mountainous locations in Sinai, such as Saint Catherine, have cooler night temperatures, due to their high elevations.

Every year, sometime from March to May, an extremely hot, dry and dusty wind blows from the south or the southwest. This wind is called khamasīn. When the flow of dry air continuously blows over vast desert regions, it picks up fine sand and dust particles and finally results in a dusty wind which is generally felt in the periphery of the desert. When this wind blows over Egypt, it causes high temperatures to soar temporarily at dangerous levels, usually over 45 °C (113 °F), the relative humidity levels to drop under 5%. The khamasīn causes sudden, early heat waves and the absolute highest temperature records in Egypt. Egypt receives between 20 mm (0.79 in) and 200 mm (7.87 in) of annual average precipitation along the narrow Mediterranean coast, but south to Cairo, the average drops to nearly 0 mm (0.00 in) in the central and the southern part of the country. The cloudiest, rainiest places are in and around Alexandria and Rafah. The sunshine duration is high all over Egypt, ranging from a low of 3,300 hours along the northernmost part in places such as Alexandria to reach a high of over 4,000 hours farther in the interior, in most of the country.

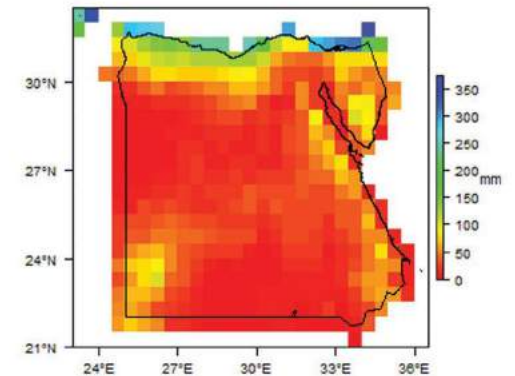
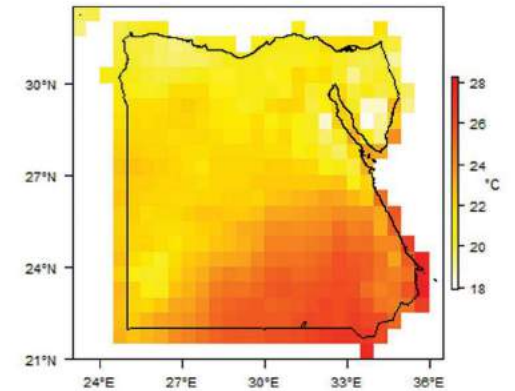
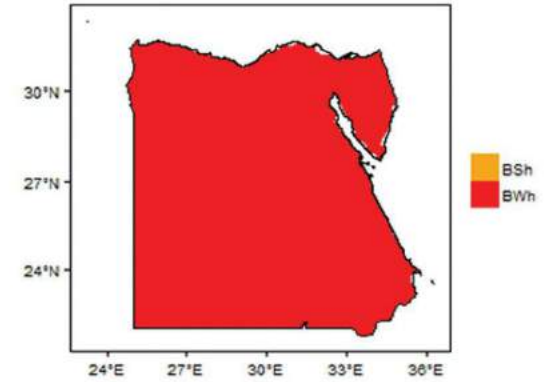
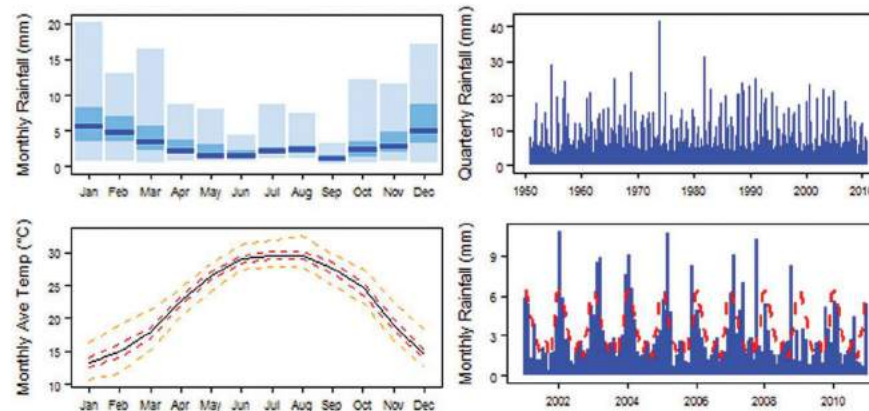



## Water resources

Egypt depends for 97% of its water supply on the Nile. Rainfall is minimal at 18 mm per year, occurring mainly during autumn and winter time. The 1959 Nile waters treaty between Egypt and Sudan allocates 55.5 billion cubic meter of water per year to Egypt, without specifying any allocation for upstream riparians besides Sudan (18.5 billion cubic meter per year). Actual water use by Egypt is widely believed to be in excess of the allocation under the 1959 agreement. There is no water sharing agreement among all ten riparian countries of the Nile. However, the riparian countries cooperate through the Nile Basin Initiative.

Satellite view of the Nile near Qena in Upper Egypt  
Egypt has four main groundwater aquifers: the Nile Aquifer, the Nubian Sandstone Aquifer, the Moghra Aquifer between the West of the Nile Delta and the Qattara Depression, and coastal aquifers on the North-Western coast. The Nile Aquifer, the Moghra Aquifer and the Coastal Aquifer are renewable. The Nubian Sandstone Aquifer System which contains 150,000 billion m<sup>3</sup> of freshwater, equivalent to almost 3,000 times the annual flow of the Nile, is non-renewable. It is shared with Sudan, Chad and Libya.

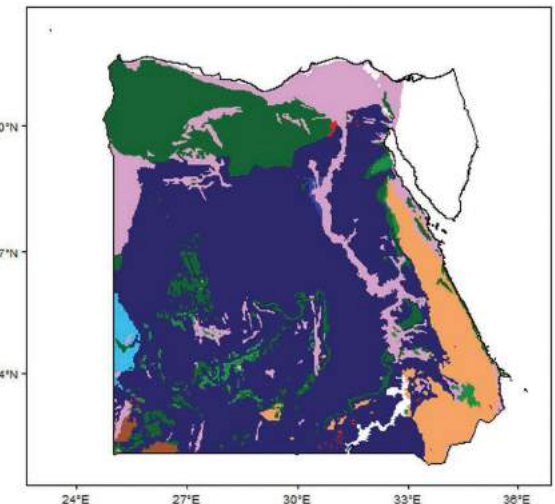
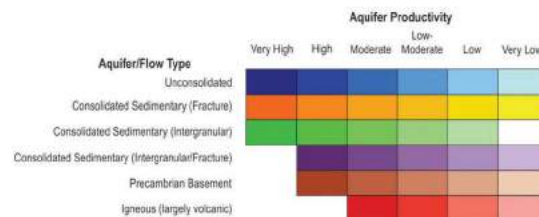
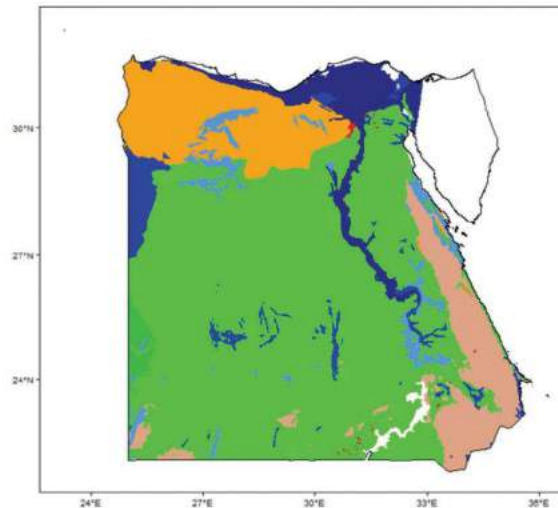
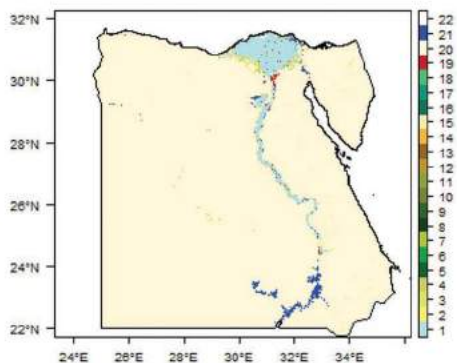
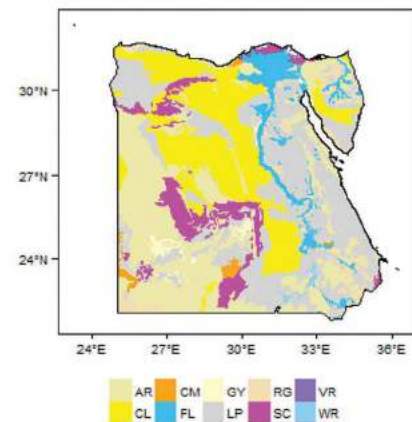
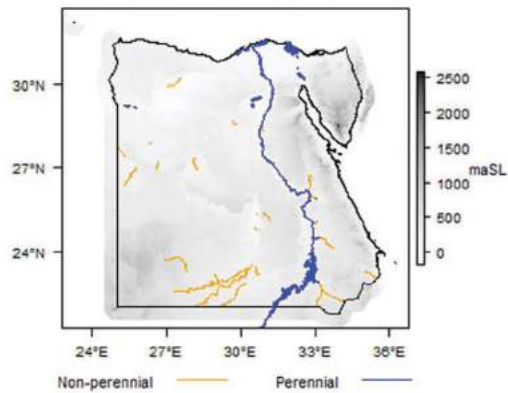



# SIWA OASIS

Location in Egypt  
29°11'N|25°33'E

*With a population of about 23,000, Siwa, the most inaccessible of all Egypt's oasis until very recently, is also one of the most fascinating, lying some 60 feet below sea level. On the edge of the Great Sand Sea, its rich history includes a visit from Alexander the Great to consult the Oracle of Amun in 331 BC. Archaeologists, such as Liana Soutvallsis implied that the great military leader was buried here, but no real evidence has come from this. The King of Persia lead a 50,000 man army to the area to destroy the*

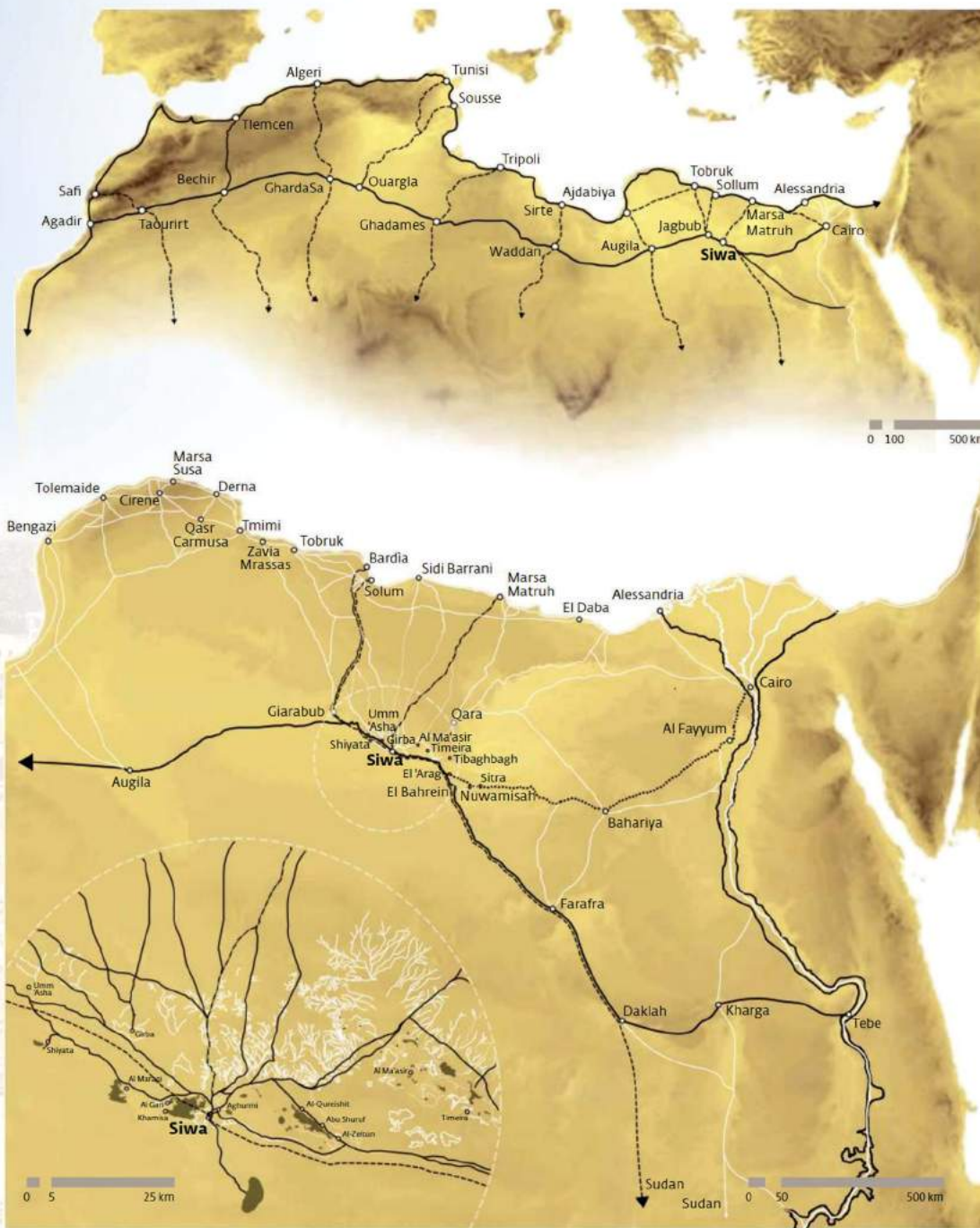
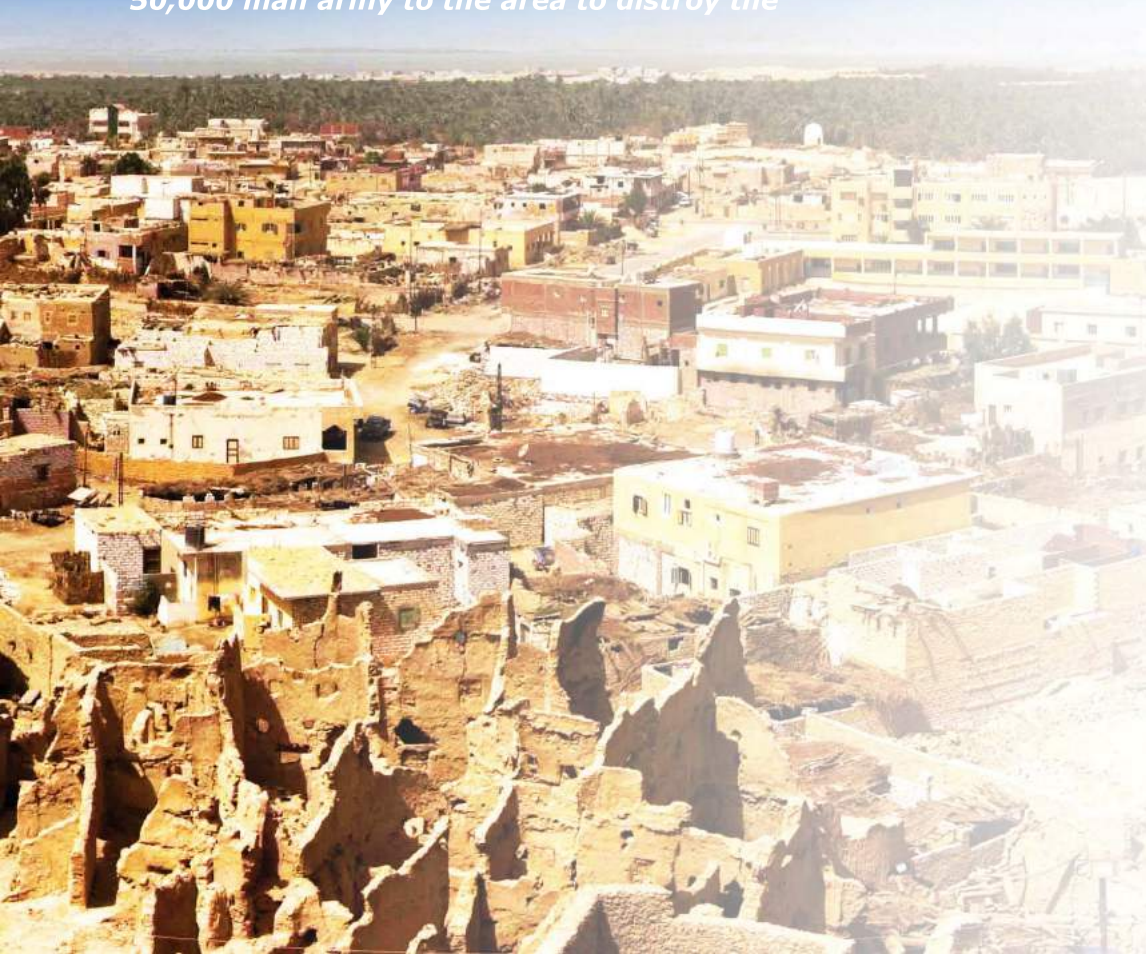

# SIWA OASIS

## history

It was occupied as early as Paleolithic and Neolithic times, and some believe it was the capital of an ancient kingdom that may have included Qara, Arashieh and Bahrein. The Siwan people are mostly Berbers, the true Western Desert indigenous people, who once roamed the North African coast between Tunisia and Morocco. They inhabited the area as early as 10,000 BC, first moving towards the coast, but later inland as other conquering invaders arrived.

*"Siwa is more North African sometimes than Egyptian and their language, traditions, rites, dress, decorations and tools differ from those of the other Western Oasis."*

There is almost nothing known of the Siwa Oasis during Egypt's ancient history. There have been no monuments discovered dating from the Old, Middle or New Kingdoms. It may have been colonized during the reign of Ramesses III, but evidence only exists beginning with the 26th Dynasty that it was part of the Egyptian empire. It was then that the Gebel el-Mawta Necropolis was established, which was in use through the Roman Period. Some sources maintain that it remained an independent Sheikdom ruled by a Libyan tribal chief until Roman times. The two temples that we know of, both dedicated to Amun.



It was the Greeks who made the Siwa Oasis notable. After having established themselves in Cyrene (in modern Libya) they discovered and popularized the Oracle of Amun located in the Siwa Oasis. Almost immediately after taking Egypt from the Persians and establishing Alexandria, Alexander the Great headed for the Siwa Oasis to consult the now famous Oracle of Amun.

Bayle St. John says that in fact the Temple of the Oracle was actually turned into the Church of the Virgin Mary. This is understandable given that along with political prisoners, the Romans banished church leaders to the Western Oasis, including, Athanasius tells us, to Siwa. In fact, we find that during the Byzantine era it probably belonged to the dioceses of the Libyan eparchy. However, no real record, or for that matter, archaeological evidence

exists to support Christianity in the Oasis. By 708 AD, Islam came to the Oasis. Though earlier than some of the other Western Oasis, it had little success at first. The Siwans may have been Christian at this point, but regardless, they withdrew to their fortress and fought valiantly against the invading forces of Musa Ibn Nusayr, finally repelling his army. Next came Tariq Ibn Ziyad of Spain, but his army was also defeated. Though some sources disagree, it was probably not until 1150 AD that Islam finally took hold in the Siwa Oasis.

However, by 1203 we are told that the population of the Siwa Oasis had declined to as low as 40 men from seven families due to constant attacks and particularly after a rather viscous Bedouin assault. In order to found a more secure settlement, they moved from the ancient town of Aghurmi and established the present city called Shali, which simply means town. This new fortified town was built with only three gates. An Islamic historian, Maqrizi, explains that soon after there were 600 people living in the Oasis. At this point the Siwa may have been an independent republic. He goes on to say that it was populated by strange and fearsome animals and that the people were plagued by unusual diseases. However, he also says of the Siwa that its fertility was legendary, citing an "orange-tree as large as an Egyptian sycamore, producing fourteen thousand oranges every year". The Siwa exported crops to Egypt and Cyrene.



One of the main historical references we have on the Siwa Oasis is called the "Siwan Manuscript" which was written during the middle ages and serves as a local history book. It tells us of a benevolent man who arrived in the Oasis and planted an orchard. Afterward, he went to Mecca and brought back thirsty Arabs and Berbers to live in the Oasis, where he established himself, along with his followers in the western part of Shali.

Unfortunately, there seems to have almost immediately been problems between the original inhabitants, who were later known as the Easterners, and the new families western families who to this day are proud to be described as "The Thirsty". The Siwans could not get along with each other, they must surely have had trouble accepting outsiders. The first European we know of to visit the Siwa Oasis was W. G. Browne, who accompanied a date caravan and disguised himself as an Arab. Then came Frederick Hornemann, a German with the African Association. Also accompanying a date caravan in disguise, he managed to fool the locals for eight days. However, he was found out and chased through the desert.

When, in 1819, Muhammad Ali, the founder of modern Egypt, began his conquest of the Western Oasis, he sent between 1,300 and 2,000 troops to the Siwa Oasis under the the commander, Hassan Bey Shamashurghi. The ensuing battle lasted for three hours, but the Siwans this time were no match for modern artillery. They had to yield to this superior force.

However, matters were not settled in the Oasis as for the distant rule of Muhammad Ali. It seems there was a repetition of him sending troops, the people of the Siwa resisting, then giving in and agreeing to pay tribute, but once the troops were gone, reneging and refusing to allow strangers into their community, so Muhammad Ali would once again send troops. Finally, in 1829, the Pasha sent 600 to 800 soldiers who conquered the Siwa, along with a ruthless governor by the name of Hasan Bey. He had eighteen Sheikhs executed and twenty others banished. He increased the tribute, and confiscated money, slaves, dates and silver as payment for the back debt. He was also responsible for building the first markaz, a government office, behind Qasr Hassuna.

In 1869 and again in 1874, Gerhard Rohlfs visited the oasis and discovered the reason why the Siwans continued to have troubles with Cairo. It turns out that the Sanusi, a power force within the Libyan desert made up of a religious order established by Al-Sayyid Muhammad bin Ali al-*Sanusi* Khatibi al-Idrisi al-Hasani, had told the Siwans not to pay their taxes. The Sanusi continued to dominate the Oasis for many years, and it was a popular crossing for their caravans, particularly those transporting slaves from Kufra. The locals helped in this endeavor, and many of the slaves remained in the Siwa, where many of their descendents remain today.

Within the 20th Century, the first Egyptian ruler to visit the Siwa Oasis was Abbas II, but even he had to disguise his Austrian wife as an Egyptian army officer. He received a warm welcome from the residence, who meet him waving palm branches while musicians played and banners fluttered. To honor his visit, the local Khedive even laid the foundation for a new mosque. It would seem that the Siwa was finally becoming a part of modern Egypt.

The Siwa was really caught up between opposing forces during World War I. Now, the Siwans found themselves in the middle of the Italians who had colonized Libya and the Sanusi, who they were most sympathetic to and who had sided with the Turks on the one hand, and the British who had colonized Egypt on the other.

During World War II, Siwa again played an important role. Most of that war saw the Siwa occupied with Allied troops consisting mainly of British, Australians and New Zealanders. It was closed to none military visitors. However, it was bombed by the Italians who had occupied Libya, killing 100 people (and a donkey, we are told), and later, the Germans had their turn in the Oasis. Even Field Marshal Rommel visited, but it was later retaken by the Allies. Afterwards, visitation to the Siwa was restricted for a number of years.





Map showing Siwa Oasis, Egypt

[https://commons.wikimedia.org/wiki/File:Siwa\\_Oasis.jpg](https://commons.wikimedia.org/wiki/File:Siwa_Oasis.jpg)

▲ 121

▲ 114

▲ 120

▲ 151

▲ 51

▲ 40

▲ 105



There are many desert paths that lead in to and out of the Siwa, but most of them remain inaccessible by modern vehicles. All of these tracks wind through passes in the escarpment, though most are not really clearly visible. The passes through which these tracks pass are known as Naqbs. Beginning in the northwest, the major ones are called Naqb Sharik, Naqb Mazura (Pass of the Measure), Naqb Qirba (Pass of the Waterskin), Naqb Migahhiz (Pass that is Prepared), Naqb Abu Beirah (Pass of the Banner), Naqb al-Baqar (Pass of the Cow, Naqb al-Mughbara, Naqb al-Barn (Pass of the Horn) and Naqb Tibaghburgh (Pass of Bubbling Water).

## The geography of the Siwa

In the Siwa Oasis, the actual desert tracks are called Masrabs, rather than darbs, as they are called in other desert oases. Beginning in the northwest, Masrab al-Ikhan, the Road of the Brothers named for the Sanusi, begins at Bahag al-Din, where it separates from the main route to the west. It ascends through the escarpment at Naqb Sharik and then leads on to the Jaghub Oasis in Libya.

Masrab al-Rukhba also begins at Bahag al-Din, but then leads north and climbs through the Naqb Mazuha. This path then drops back into the depression and joins the Masrab al-Ikhan. These two tracks sometimes collectively known as the Masrab Haramiya, or Thieves' Roads, were actually the major routes between Egypt and Libya, and were among the most traveled in the Western Desert during the late nineteenth and early twentieth centuries. They were the routes of the Sanusi, and in fact, the routes began in Cairo or Alexandria, worked their way through Wadi Natrun or the northern coast across Qattara through Qara, and into the Siwa. After passing by the Siwa and through the Jaghub Oasis, they then crossed through Kufra and Zuila, where they joined the north-south slave routes going north to Tripoli or south to Lake Chad. Just north of Zuila, the road is paved with what might be Roman milestones. There are also several tracks to Sallum on Egypt's north coast bordering Libya. The first is Masrab al-Shaqqa, which is also sometimes known as the Masrab Diqnash. This path runs for 310 kilometers, beginning in the western section of the depression. It runs over the escarpment and then turns due north to Sallum. The second one is Masrab Sheferzen, which cuts off from the main road, which is the Masrab al-Istabl, north of Siwa. Two other roads, known as the Masrab al-Khamsa, or Road of the Five (because there were five wells along the path), and Masrab al-Qatrani, known as the Road of Tar, both go to Sidi Barrani on the north coast of Egypt. Most people heading to the Siwa probably take the most important route, known as the Masrab al-Istabl, or Stable Road.

It begins along the northern coast at Mersa Matruh, and travels south by way of Wadi al-Raml, Bir Gueifire and the Naqb al-Hanayis to the halfway point called Bir Fuad al-Awwal, or Bir al-Nuss. From there, it continues south to Ras al-Hamraya, and enters the depression at Naqb Migahhiz. Along the way, another path cuts south to join Masrab Khidida to the Qara Oasis, while further along the track, another path cuts northwest and leads to Gazalah on the coast. Also, on the eastern edge of the oasis, Masrab Khidida climbs its way out of the depression and heads toward the Qara Oasis by way of Naqb Abyad,



Naqb al-Ahmar and Naqb Khamsa. After passing through Qara it then leads to Gazalah. Another famous route, and one that some travelers like to use today, though it is highly controlled by the military, is the Masrab Bahariya, which links this oasis with the Bahariya Oasis (where it is called Darb Siwa). The reason people like this road is because it travels through the Areg, Bahrein and Sitra Oasis, where some ruins can be found (particularly at Areg). It runs about 300 kilometers, and was only recently paved. Within the Oasis The main city in the Siwa is the city of Siwa itself, where most of the inhabitants of the Oasis live. The ancient city was Aghurmi, which is to the north of the modern one, while just to the south of the modern city center is Shali, a more recent fortified town built with only three gates, probably in about 1203 AD.

There are also other small districts and villages within the Siwa, most of which run along the main tracks to the Bahariya Oasis on the northern side of Birket Zaytun and along the road leading around Birket Siwa that eventually branches off at Bahaj al-Din into Masrab al-Rukhba. Along the latter road, leading east are Gahayba, Gari, Maraqi, Balad al Rum and Bahaj al-Din. To the south, above Birket Zaytun, leading east are Quruyshat, Avu Shuru and Zaytun. The area in the western part of the Oasis around Gari and Gahayba is some of the most fertile parts of the Siwa, with the best olive gardens and other crops, while nearer to Balad al-Rum is also good, but known more for its pasture land. However, the gardens around Al-Zaytun are the most famous of the oases, and probably the richest.



Siwa represents the last virgin oasis in the western desert of Egypt. Recently, serious environmental changes pertaining to the invaluable groundwater resources, such as soil salinity and expansion in surface lakes have developed due to excessive uncontrolled groundwater discharge associated with land development for agriculture. The optimum pumping should be close to 520,000 m<sup>3</sup>/day with important disturbances in the pressure head encountered between Bahei ElDin Lake and Zeitoun Lake. This aquifer stress is capable of lowering the pressure head to stop artesian flow and in consequence saves large water quantities draining daily to the lakes through natural flow and mitigates the waterlogging problems. In addition, minimal changes are observed in the eastern part of the modeled area suggesting additional production wells to tap the aquifer system at this barren area and initiate new development projects. Such results demonstrate the potential.



## Water Resources

Over the past century, the total population of Egypt increased from 11 million in 1907 to 73.4 million in 2004, while the area of cultivated land has only increased from 2.25 million to around 3.5 million ha (Abdulaziz et al. 2009). As a consequence, the area of land per capita has fallen from 0.2 to 0.05 ha during the same period (FAO 2005). To accommodate the increasing demands for food, attentions are usually paid to reclaiming the desert, but the success of such agricultural projects is entirely restricted to the availability of sustainable water resources. This is probably the reason behind the development programs of the "New Valley Project" and the "South Egypt Development Project," great projects of land reclamation around the oases of the Western Desert and south Egypt respectively.

*The New Valley Project* or Toshka Project consists of building a system of canals to carry water from Lake Nasser to irrigate part of the sandy wastes of the Western Desert of Egypt, which is part of the Sahara Desert. In 1997 the Egyptian government decided to develop a new valley (as opposed to the existing Nile Valley) where agricultural and industrial communities would develop. It has been an ambitious project which was meant to help Egypt cope with its rapidly growing population. The canal inlet starts from a site 8 km to the north of Toshka Bay (Khor) on Lake Nasser. The canal is meant to continue westwards until it reaches the Darb el-Arbe'ien route, then northwards along the Darb el-Arbe'ien to the Baris Oasis, covering a distance of 310 km.

*Sahara Desert into land for agricultural and industrial development and secondarily to promote economic activity that would reduce high rates of unemployment amongst Egypt's youth. Extensive hydrographic and hydraulic analyses were undertaken to choose the best location for the project and its intake feeders. Planners chose Toshka, East Oweinat and the New Valley oases as the best location for the new development; these areas already had pristine land that supported crops and the idea was to expand them.*

*The South Valley Development project, an attempt to relocate up to 6 million Egyptians was started in the 1980s to convert one million "feddans" (1.038 million acres) of the*

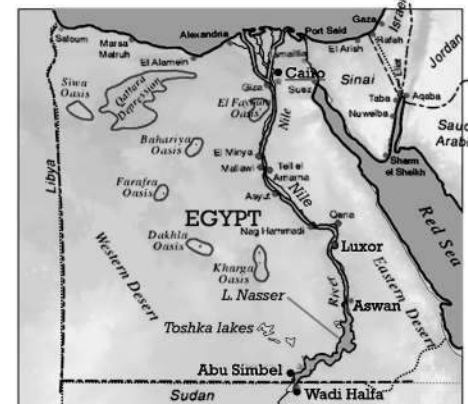



While the agricultural land reclamation of the New Valley Project initiated in 1960 is based exclusively on groundwater from the Nubian Sandstone aquifer, the south Egypt development project commenced in 1995 is based on the conjugated use of groundwater from the same aquifer and surface water pumped from Nasser Lake (Ebraheem et al. 2004). Nubian Sandstone is Cambrian to Late Cretaceous and is predominantly continental sediments extending over 2,000,000 km<sup>2</sup> underneath the eastern Sahara with confinement condition prevailing to the north of latitude 25° N. Hydrologically unsteady aquifer over the past thousands of years, is known to be fossil water and its abstraction is un-renewable. Calculated inplace groundwater of the Nubian Sandstone aquifer is arguable about 28,000 km<sup>3</sup> (Ebraheem et al. 2002). The estimated age of groundwater from the Nubian Sandstone aquifer has been 25,000–40,000 years (Heinl and Brinkmann 1989) using Carbon14.

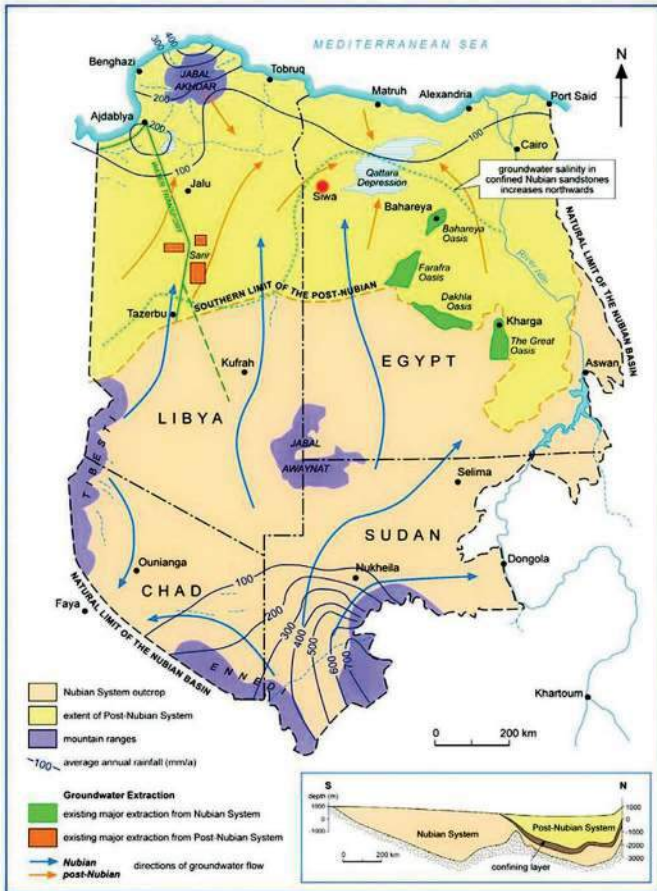

The recharge to the fractured carbonate aquifer underneath Siwa Oasis is largely disputable between local recharge from the deep Nubian Sandstone aquifer and surface recharge at a faraway catchment area near Gebel Akhdar, Libya. Large-scale land development usually associates serious ecological and socioeconomic problems, such as water-logging phenomenon, rapid falling water level and groundwater depletion, salt water intrusion, and disturbance to the overall groundwater system. The situation becomes worse if high natural discharge of poor-quality groundwater through natural springs and/or uncontrolled dug wells is involved, which is recognized in Siwa Oasis.

Siwa represents the smallest oasis located in the Egyptian part of the extensive Libyan Desert and depends exclusively on groundwater resources and drainage water reuse. Recently, farmers started to experience the challenging rising water level in the soil zone together with the groundwater salinity and the escorted waterlogging and soil salinization, especially in the topographically low lands at the proximity of the drainage lakes.

**Studies indicated that more than 50 % of the naturally flowing groundwater through natural springs or wells tapping the confined aquifers is dispensed into salt ponds through the poor drainage system.**

Through an action plan over the past few years, 80,000 m<sup>3</sup>/day discharged through 180 critical well was managed and terminated to save approximately 40 % of the disposed groundwater.

### site description

Siwa Oasis occupies an EW elongated depression in the northwest part of the western, 300 km from Mersa Matruh, between latitudes 29°05'00" N and 29°25'00" N and longitudes 25°05'00" E and 26°06'00" E, with an area of approximately 1,200 km<sup>2</sup>. Topographically, five local depressions are easily recognized in Siwa Oasis, the area lying below the zero elevation contours, and vary in altitude between 01 and -18 m above the mean sea level. These depressions host the important lakes recognized from west to east as Maraqi, Siwa, Aghourmy, and Zeitoun lakes. The important activity in Siwa is farming that showed a surplus increase from 2,000 acres in 1962 to 12,000 acres in 2012 and the main crops are dates and olives. At the environs of Siwa Oasis, the Middle Eocene chalky limestone (75 m) is exposed and overlain by quartzitic gravel and silicified wood west of Timeira. In subsurface, the Moghra Formation, a clastic fluvio-marine deltafront sequence of Early Miocene that grades laterally to marine facies, unconformably overlies the Upper Eocene. At the depression, a 94m thick Marmarica Formation of the Middle Miocene forms the

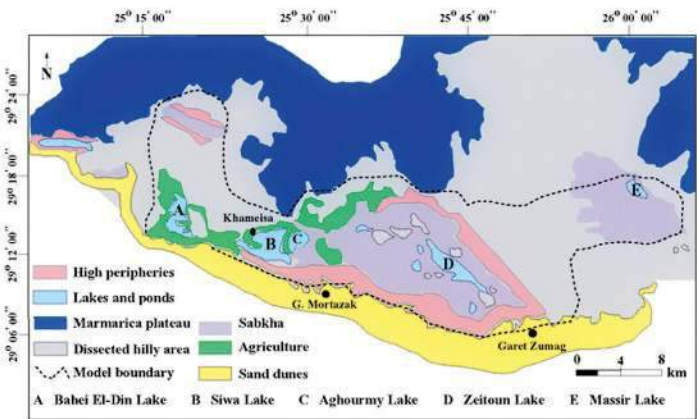

greater part of Siwa Oasis and comprises mainly limestone, dolomite, and shale. It mainly forms the northern scarp (78 m height) and many of the hills at Gebel EIDakrou, Martazak, Zomag, ElMawta, and Khameisa. Tertiary rocks are covered by the Quaternary alluvium and eolian deposits that constitute 2–3 m soil zone that is replaced by salt or sabkha at the proximity of the lakes. The tectonic evolution in Siwa area indicates a complicated geologic history of uplift and subsidence with developed folds, horsts, and grabens.

Water wells and springs are the only water supply available in Siwa Oasis with the majority tapping the shallow carbonate aquifer at depths between less than 10 and 120 m and few deep wells (±1,000 m) that pump a total of 400,000 m<sup>3</sup>/day to meet the water demands for agriculture and municipal uses. Most of these wells, especially the shallow and the hand-dug wells, are poorly designed and lack casing and discharge valves to control the artesian flow. Given that irrigation wells and springs are usually supplemented by water storage tanks to store the irrigation water of salinity between 1,200 and 7,000 ppm, it is common to encounter a localized waterlogging nearby these tanks at each farm.

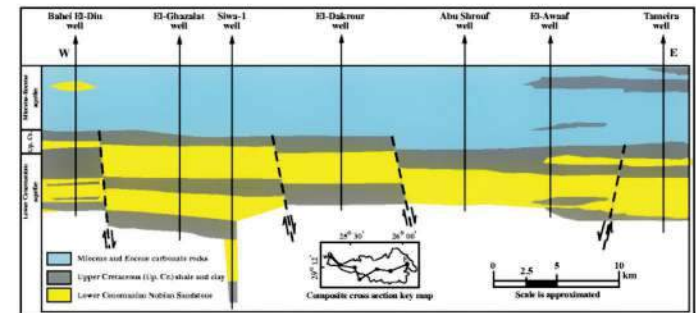

**In the present study, a threedimensional finite difference model was developed to simulate groundwater flow in the Nubian Sandstone and carbonate aquifers underneath Siwa Oasis. This model results demonstrate the potential of groundwater flow modeling in water resources management to define the optimum pumping scenarios capable to mitigate environmental problems.**

*3D view of the 13 deep wells together with their lithological succession (upper) used in building solids of Siwa model and map view (lower) showing their spatial distribution (black circles). The blue hexagons in the lower map represent the location of the six monitoring stations*

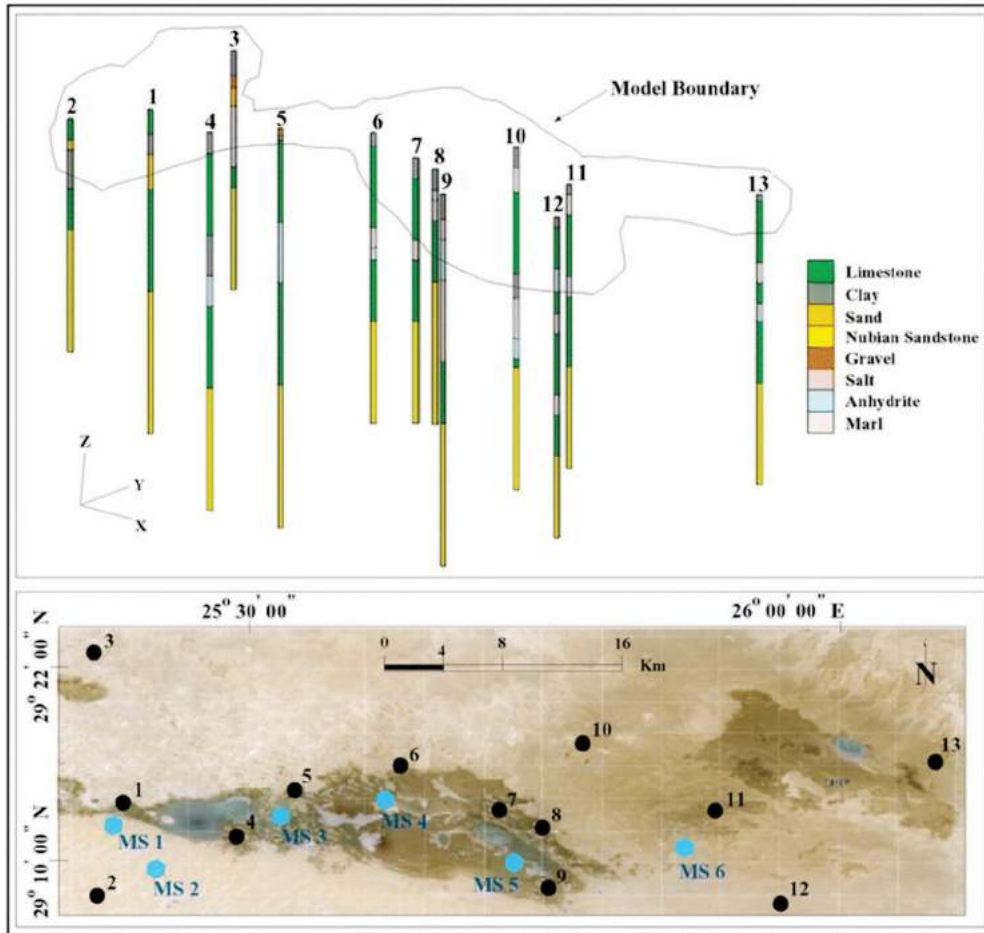

## Study results

Theoretically, several strategies can be adapted to groundwater development in Siwa region, but the selected strategy should remain a practical methodology (Farid and Tuinhof 1991). Three main groundwater development strategies were developed for evaluation using drawdown in head against groundwater abstraction over 50-year period. These strategies include low (400,000 m<sup>3</sup>/day), intermediate (500,000 and 600,000 m<sup>3</sup>/day), and relatively high (800,000 m<sup>3</sup>/day) pumping stresses.

The calibrated groundwater flow model of Siwa Oasis provides a detailed description to the configuration of the hydrogeological system and spatial distribution of the groundwater level in the consecutive layers of the important aquifers, carbonate and Nubian Sandstone, associating the different proposed scenarios. The average reported pressure head in the artesian flowing deep wells in Siwa varies between 70 m a.m.s.l. in areas of great aquifer discharge, the area between Bahei EL Din Lake and Zeitoun Lake, and 120 m a.m.s.l. in the south eastern area. Alternatively, the groundwater head in the carbonate aquifer varies in average between 50 and 60 m a.m.s.l. that shows a considerable difference to the pressure head in the Nubian Sandstone aquifer. Such a hydrologic setting favors a dominant local recharge to the carbonate aquifer via the upward leakage from the Nubian Sandstone aquifer through fault plains and the developed fracture system.

The dominant groundwater flow in Siwa area follows WNW direction with two major local flow systems encountered at the vicinity of Maraqi and Siwa lakes. These local flow systems are associated to discontinuity in the hydrostratigraphic units that correlate with the extensional faulted bedrocks, and such setting strongly supports the theory that the area is a structurally controlled tectonic depression. This hydrogeological setting together with high groundwater discharge through natural springs and/or uncontrolled dug wells may ultimately lead to further extension in the surface area of the lakes; for example, the surface extension of the lake Siwa has increased from 5.82 in 1987 to 25.97 km<sup>2</sup> in 2003.

3D view of the gridded solid (lower) and east-west cross section (upper) showing the complex distribution of the different units in Siwa model. The yaxis follows the north direction; figures are not to scale

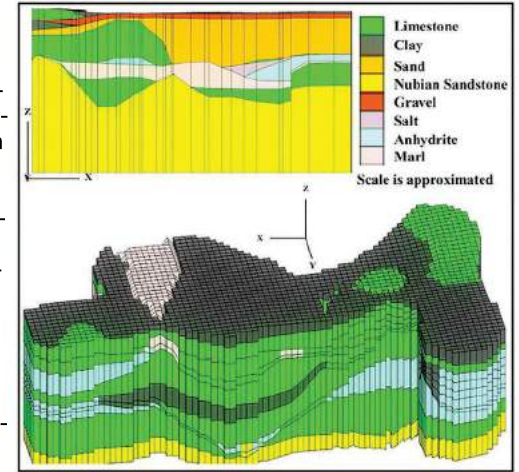

Furthermore, the tectonic history not only controlled the groundwater flow toward the topographic depressions occupied by the lakes but also configured the orientation of the lakes (Knetsch and Yallouze 1955) toward the NW following the normal faults while the coupled slip movements may dissect large lakes into parts such as the NE trending regional fault dislocating Massir Lake from Zeitoun Lake.

Monitoring the ground water levels in shallow and deep wells throughout Siwa Oasis indicated direct hydraulic interaction between the Nubian Sandstone aquifer and the overlying carbonate aquifer. This stands true for settings at the proximity of high vertical hydraulic conductivity and/or where the aquitards are thin or extinct; otherwise, such interaction seems unclear as observed in evaluating the present model output. The pressure head in the different layers of the steady-state and transient models indicated that the head in the upper two layers (layers 2 and 5) of the carbonate aquifer is almost identical, except for the middle part where the separating marl layer is well developed. Such similarity indicates hydraulic continuity and uniform distribution of the confining pressure through the two layers and therefore can be denoted as the upper carbonate aquifer.

This obviously indicates the direct groundwater replenishment of both shallow clastic and carbonate aquifers through the vertical leakage from the deeper Nubian Sandstone that widely extends throughout Egypt and part of Libya. To evaluate the feasibility of various exploitation plans for the groundwater resources in Siwa Oasis, the calibrated transient model is utilized to evaluate the impact of a total discharge of 400,000, 500,000, 600,000, and 800,000 m<sup>3</sup>/day from both carbonate and Nubian Sandstone aquifers. In addition, the results may help to indicate the optimum pumping rate that controls the natural flow from springs and untapped shallow handdug wells.

Detailed water budget analysis for different layers through the different scenarios indicated that there is more than 320,000–570,000 m<sup>3</sup>/day of groundwater abstracted from the carbonate aquifer, particularly layers 5 and 7 of the upper carbonate aquifer. While considerable volume of the additional pumping stress targeted the lower parts of the model, layers 9 and 10, 2535% the total stress was assigned to the upper carbonate aquifer. In addition, the simulation results of various pumping stresses indicate that the recommended pumping scenario should fall between 500,000 and 600,000 m<sup>3</sup>/day and such increase in groundwater abstraction should be gradual. These values are defined by marked fall in groundwater head of the shallow aquifers that considerably reduce the natural flow of the hand dug wells and springs tapping them. Accordingly, several trial runs have been tested to define the optimum pumping rate that preserves the groundwater system balance under the current boundary conditions. The model run that best fits the above criteria has adopted a total abstraction of 520,000 m<sup>3</sup>/day from the carbonate and Nubian Sandstone aquifers. This total abstraction is expected to save large water quantities draining daily to the different lakes and mitigate the waterlogging problems in Siwa Oasis. Furthermore, additional production wells should tap the area east of Zeitoun Lake that seems suitable to host new development projects. Finally, it is recommended to continue the monitoring programs of groundwater level and soil salinity to update the model input and apparently test the reliability of the model output.

Layer	Daily pumping rate scenarios (<math>\times 1,000 \text{ m}^3/\text{day}</math>)			
2	40	40	40	40
5	145	150	160	170
7	170	190	220	300
9	20	40	70	100
10	25	80	110	190
Total	400	500	600	800

*Simulation of impact of present and future groundwater extraction scenarios from the nonreplenished carbonate and Nubian Sandstone Aquifers in Siwa Oasis indicated the presence of local flow systems at the vicinity of Bahei ELDin Lake and Siwa Lake, interrupting the regional WNW groundwater flow system. These local flow systems are tectonically dependent and generally associate zones of significant high vertical hydraulic conductivity that match the development of normal faults. The multilayer model simulations indicated that most shallow wells will cease artesian flow if the total abstraction increases to 500,000 m<sup>3</sup>/day while phenomenon of natural flow would disappear if the pumping rate increased to 800,000 m<sup>3</sup>/day. The optimum pumping rate that best fits the aquifer potentiality and controls the artesian flow was found close to 520,000 m<sup>3</sup>/day from the carbonate and Nubian Sandstone aquifers. The insignificant disturbances in pressure head with various pumping stress in the eastern part of the modeled area are attributed to the few production wells and lack of important human activities. The gleaned information represents the importance of multilayer*

Plane view to the head distribution in upper carbonate aquifer (layer 5), lower carbonate aquifer (layer 7), and Nubian Sandstone aquifer at the end of the 50-year time span due to different pumping stresses: 600,000 m<sup>3</sup>/day, and 800,000 m<sup>3</sup>/day

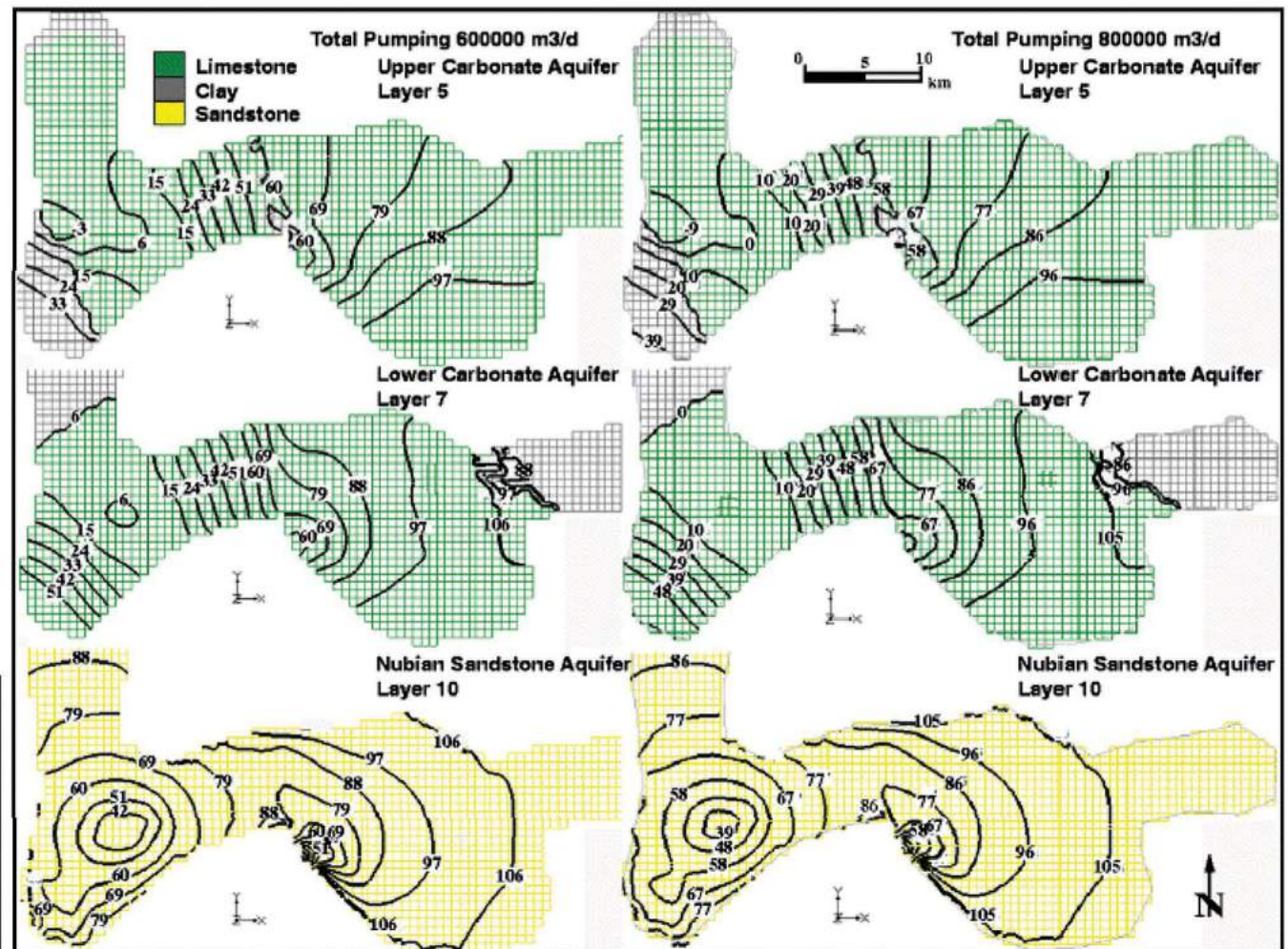

# climate

Siwa Oasis, Egypt is at 29°12'N, 25°29'E, 13 m (43 ft).

Siwa Oasis has a subtropical desert / low-latitude arid hot climate (Köppen-Geiger classification: BWh)

According to the Holdridge life zones system of bioclimatic classification Siwa Oasis is situated in or near the subtropical desert biome.

The average temperature is 21.7 degrees Celsius (71 degrees Fahrenheit). See the temperatures page for a monthly breakdown and the fixed scale graph.

Average monthly temperatures vary by 17.8 °C (32°F). This indicates that the continentality type is oceanic, subtype truly oceanic.

Total annual Precipitation averages 9 mm (0.4 inches) which is equivalent to 9 Litres/m<sup>2</sup> (0.22 Gallons/ft<sup>2</sup>).

Were you to burrow down through the centre of the Earth from Siwa Oasis you would pop up nearest to the climate station at Rurutu, French Polynesia.

Climate data for Siwa													[hide]
Month	Jan	Feb	Mar	Apr	May	Jun	Jul	Aug	Sep	Oct	Nov	Dec	Year
Record high °C (°F)	29.3 (84.7)	34.6 (94.3)	41.6 (106.9)	44.8 (112.6)	48.0 (118.4)	48.2 (118.8)	45.2 (113.4)	46.2 (115.2)	42.8 (109)	41.9 (107.4)	37.5 (99.5)	29.0 (84.2)	48.2 (118.8)
Average high °C (°F)	19.3 (66.7)	21.5 (70.7)	24.5 (76.1)	29.9 (85.8)	34.0 (93.2)	37.5 (99.5)	37.5 (99.5)	37.0 (98.6)	34.6 (94.3)	30.5 (86.9)	25.0 (77)	20.5 (68.9)	29.3 (84.7)
Daily mean °C (°F)	12.1 (53.8)	14.0 (57.2)	17.3 (63.1)	21.9 (71.4)	25.8 (78.4)	29.2 (84.6)	29.9 (85.8)	29.4 (84.9)	27.1 (80.8)	22.8 (73)	17.3 (63.1)	13.2 (55.8)	21.7 (71.1)
Average low °C (°F)	5.6 (42.1)	7.1 (44.8)	10.1 (50.2)	13.7 (56.7)	17.8 (64)	20.4 (68.7)	21.7 (71.1)	21.4 (70.5)	19.5 (67.1)	15.5 (59.9)	10.2 (50.4)	6.5 (43.7)	14.1 (57.4)
Record low °C (°F)	-2.2 (28)	-1.3 (29.7)	0.3 (32.5)	5.7 (42.3)	7.5 (45.5)	14.0 (57.2)	17.5 (63.5)	15.9 (60.6)	11.7 (53.1)	7.8 (46)	2.9 (37.2)	-0.7 (30.7)	-2.2 (28)
Average precipitation mm (inches)	2 (0.08)	1 (0.04)	2 (0.08)	1 (0.04)	1 (0.04)	0 (0)	0 (0)	0 (0)	0 (0)	0 (0)	2 (0.08)	1 (0.04)	9 (0.35)
Average precipitation days (≥ 1.0 mm)	0.3	0.1	0.1	0.2	0	0	0	0	0	0	0.1	0.2	1.0
Average relative humidity (%)	56	50	46	38	34	33	37	41	44	50	56	59	45.3
Mean monthly sunshine hours	230.7	248.4	270.3	289.2	318.8	338.4	353.5	363.0	315.6	294.0	265.5	252.8	3,540.2
Source #1: NOAA <sup>[24]</sup>													
Source #2: Climate Charts <sup>[25]</sup>													
Climate data for Siwa Oasis / Markaz Siwa													[show]

The prevailing wind to the Mediterranean Sea continuously blows over the northern coast without the interposition of an eventual mountain range and thus, greatly moderates temperatures throughout the year. Because of the effect, average low wind[1] vary from 9.5 °C (49.1 °F) in wintertime to 23 °C (73.4 °F) in summertime and average high temperatures vary from 17 °C (62.6 °F) in wintertime to 32 °C (89.6 °F) in summertime.

Every year, sometime from March to May, an extremely hot, dry and dusty wind blows from the south or the southwest. This wind is called khamasīn. When the flow of dry air continuously blows over vast desert regions, it picks up fine sand and dust particles and finally results in a dusty wind which is generally felt in the periphery of the desert. When this wind blows over Egypt, it causes high temperatures to soar temporarily at dangerous levels, usually over 45 °C (113 °F), the relative humidity levels to drop under 5%. The khamasīn causes sudden, early heat waves and the absolute highest temperature records in Egypt.

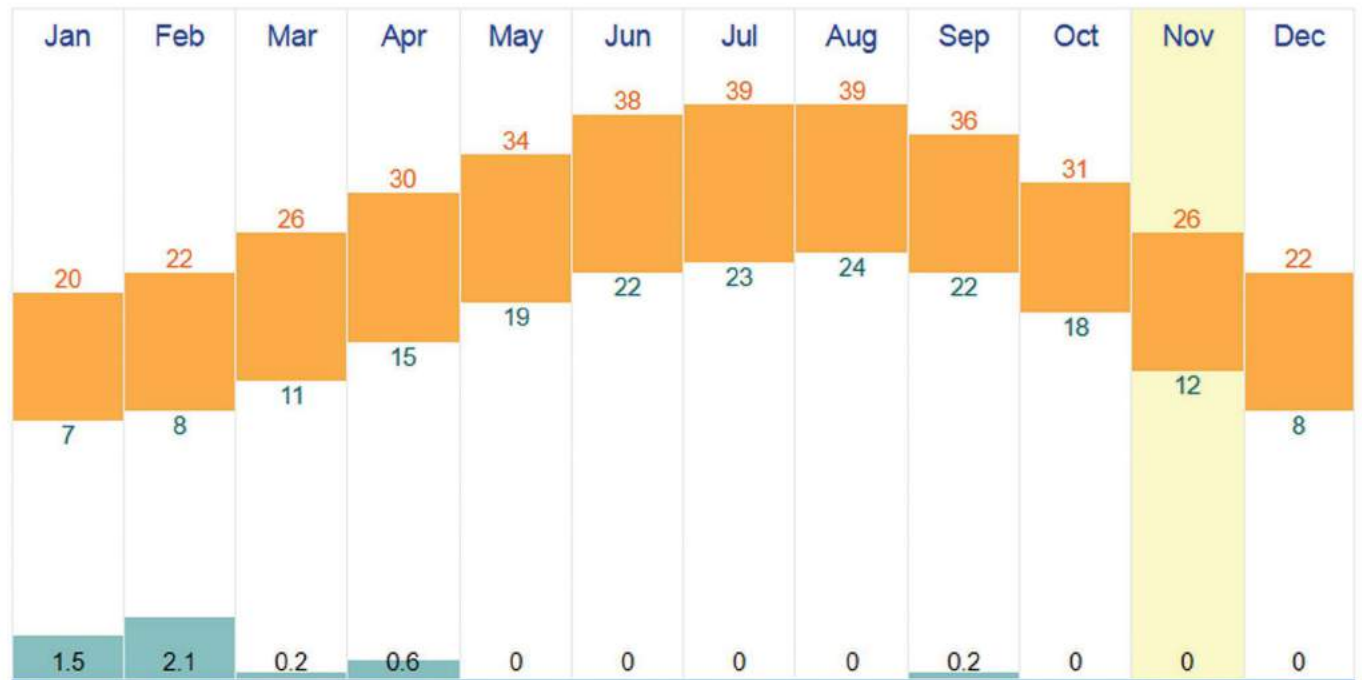

## Architecture

### The Siwan House

Traditional Siwan houses are very economical, as all the building materials are culled from our own gardens or from the salt lakes. Houses are built with **karsheef**, a stone made of a mixture of clay, salt and fine sand that forms at the shores of the salt lakes. When bonded with clay, karsheef walls become a single, solid unit and are quite sturdy. Ceilings and doors are made of **palm wood**, and mud and olive leaves help strengthen the roof against the rain.

Most houses have two floors and a roof top terrace, where we sleep in the summer or sit in the evening for dinners and chats in the open air. The second floor has bedrooms, a sitting room and a kitchen. The first floor usually has one room called the **winter room**, or "gharfit nshtee." It's a very

warm room because it's small, down below and has small windows. On the cold winter evenings, the whole family sits around a heath called "al kor" – a plate of glowing hot olive wood coals placed in the middle of the room.

Behind the house is the home **bakery**, or "stah." A canopy of palm fronds or reeds provides some shade, otherwise the area is open to allow the smoke from the clay oven to escape. The clay oven, or "tabunna," is used for baking bread and is fueled with palm branches. Most homes also have two "amunsees," smaller clay ovens used for regular cooking, although now most people use butane stovetops.

This house doesn't cost the Siwan, just his personal labor in the garden. This house is suit

able for him year round. It's almost completely perfect in all seasons, but there is one problem. Although the karsheef stones are strong and dry, and insulate against the heat and cold, and wards off flies and insects – unfortunately it cannot withstand **strong rain**, which rarely comes to Siwa, but destroy houses. It destroys them completely, as in 1930, 1970 and 1985. Also, the problem the with the palm tree wood – **termites**. The cellulose of the palm wood is the preferred food of the white ant. These ants grow in some houses, which makes many people to leave these houses because it was the reason of them falling down. It makes them start to build modern houses from white stone, changing the view of Siwa Oasis.

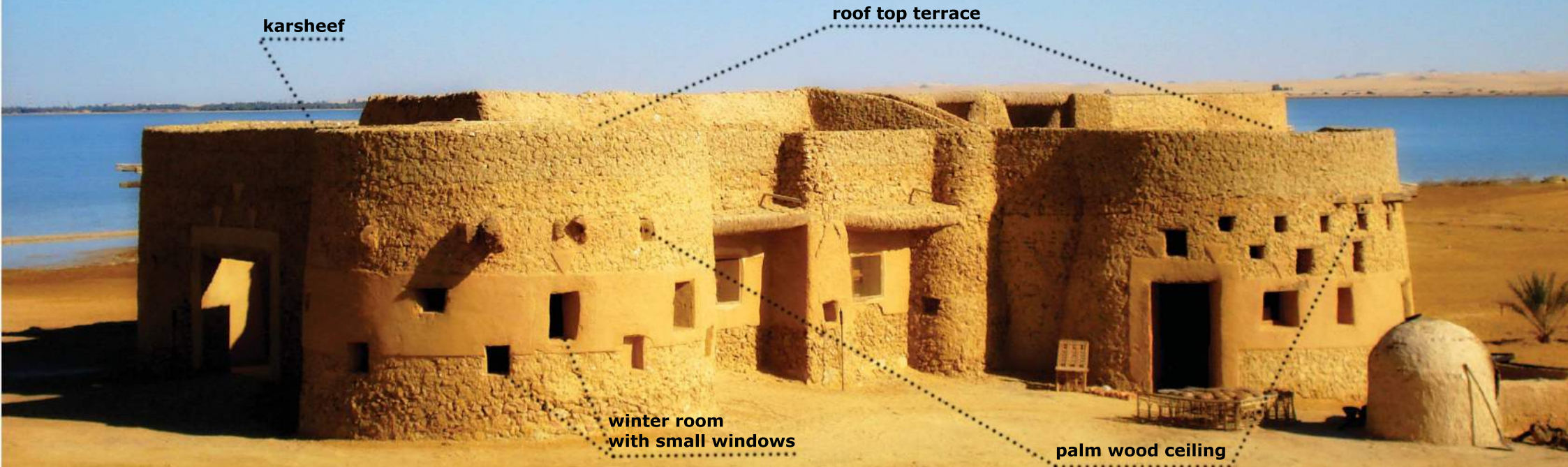

## architecture

SOURCE: R.M. Ahmeda research paper

### Lessons Learnt from the Vernacular Architecture of Bedouins in Siwa Oasis, Egypt

The Bartlett School of Graduate Studies, University College London, UK

*study of three vernacular buildings, in order to identify the best practice and the most appropriate systems for climatic responsive low-carbon buildings.*

Siwa oasis is considered to be one of the ancient oases since pharaohs' days, called the oasis "mercy islands" as they represented the resting place for travelling tribes in the desert. The ancient Egyptian name of Siwa was "Sekht-am" which means the palm land. It is one of the few Egyptian oasis communities that have managed to retain most of its traditional characteristics. Dwellings were built side-by-side along steep, narrow and winding dirt roads, yet largely abandoned and left to collapse. Recently, heavy unusual rains damaged the dwellings, leading the population to abandon Shali. As a natural response to adapt to the harsh conditions of Siwa's arid desert environment, dwellings are generally characterised by being compact in shape for minimizing the amount of building surface exposed to the direct radiation of the sun and the alleys in between are narrow and often covered and shaded streets to avoid the heat of the sun and extreme brightness and provide ventilation shaft. Another natural technique was used for cooling the air during the hot summer

*13th century urban structure within the Siwa - high density of dwellings that provides shade.*

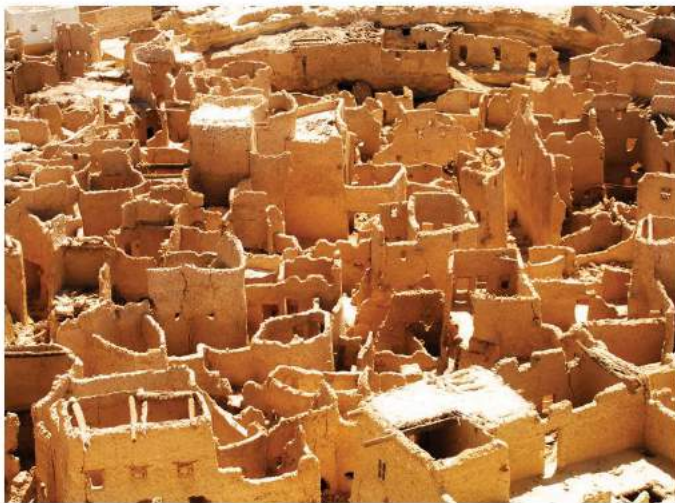

*Plan of the 13th century urban structure within the Siwa Oasis (drawings courtesy of the following authors: Calvano S., Loconte P., Pizzolante S., Ricupero P. and Vitulli A.).*

is the use of vegetation beside the openings and hence improving cooling the air before passing through the windows. Moreover, wind towers and atriums were used inside the houses. Also the windows were oriented opposite to each other's for creating cross ventilation. The construction technique are connected to the natural resources with **Karsheef blocks, salt** from the salt rich soli was dehydrated via leaving it in a direct sun exposure. Then '**Tlakht**' is used as the filling material which is again fermented wet mud from the salty soil left for one week or two to dry. Buildings normally don't exceed 5 meters high. Thickness of walls is normally 50cm starting from the first row in the ground reaching 30 cm thick in the last row. Currently, Karsheef building technique is abundant owing to the high moisture content in the soil, so it determined insulation before the workers immense in the building. Nevertheless, during the construction phase, the builders had to build layer by layer after making sure that the sand Karsheef blocks get dried. Hence, recently Siwans have started to replace their traditional Karsheef buildings with typical white blocks and cement as a mean by they save time.

### House of a Siwan: Haj Ali

The house of Haj Ali, occupying around 350 m<sup>2</sup>/ floor and 10 meters height. The building has been selected as it is one of the typical Siwans' Karsheef built houses which are in a good condition up to date. The building has two storeys connected by a central staircase also serving as a ventilation shaft, and a backyard sitting area for men 'khos', a guest room 'almarbouaa' for visitors who visit the family on more frequent basis located close to the main entrance with a separate door from outside to insure privacy for the family member. The external walls are painted for emitting the solar radiations. Inside the house, a small entrance lobby welcomes the visitors; family members pass through this area to access their private area upstairs. Storage room is located in the area between the entrance lobby and the kitchen, followed by the family living area. Interestingly enough, the stair case tower is used as lighting pipe where mirrors have been installed on the walls to reflect the sun light inside the house as shown on the diagram below, beside acting as a cooling tower as well.

*External view of Haj Ali's house*

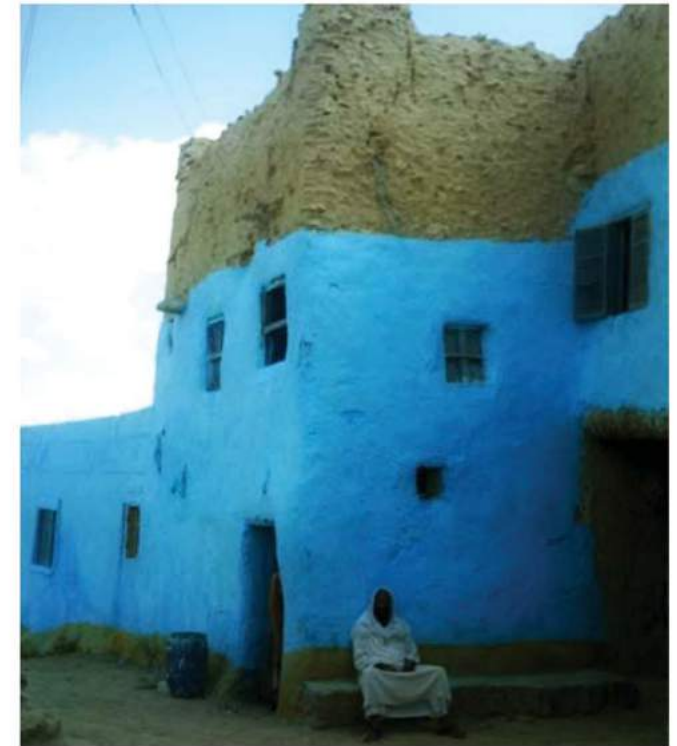

On the upper floor, bedrooms are located with a central living area in which the family member gather, eat and discuss the family issues. Besides, the bedrooms are separated in to roofed rooms for sleeping in winter and non-roofed for sleeping in summer to replace the use of any mechanical modes for cooling during the hot summer. On a similar basis, another un-roofed kitchen is located on the upper floor in addition to the one in the ground floor. The upper kitchen 'Tabent' is actually the one sued for cooking, equipped with a built-in Kershef cooker for minimising the use of electricity as well. house was built first with 50 cm high concrete wall on the ground floor level, which is not costly to build for isolating the ground water from the Kershef blocks. Then they determined the areas of the room and afterwards they started building with the thick Kershef blocks until they reached the desired height. They repeated this for each single room. Following, they supported their walls with palm wood trunks connections on roofs to achieve straight endings of the building's walls, which was used as decorative element for interior design as well.

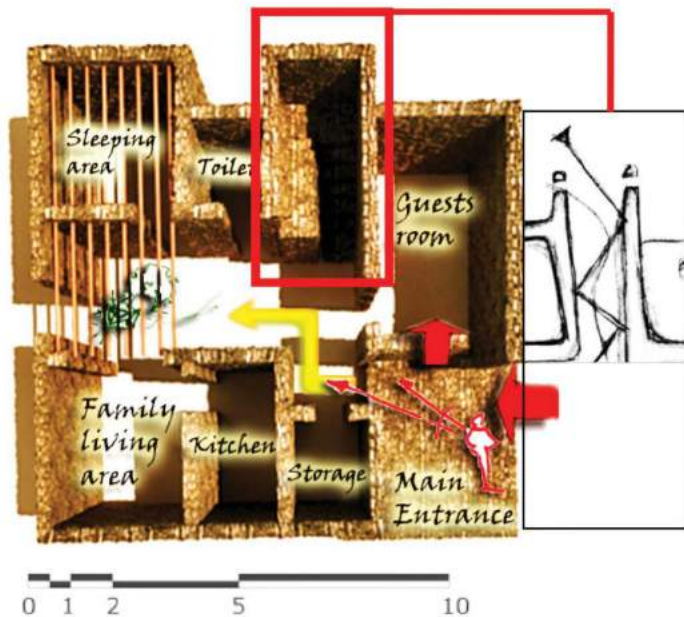

Left: Ground floor plan of Haj Ali house comprises of: L-shape entrance, 1 guest room, 2 storage, family living area, open roof sleeping area, toilet and a stair case leading up stairs to the bedrooms

Right: the stair case acting as a lighting pipe

### low cost climatic responsive building techniques adopted by the traditional Siwans' houses

*Best utilisation of the local material for climatic responsive zero carbon emission building, while using the local material for building the cooker to minimise the electrical devices.*

*Using the stair case tower as an atrium for passive ventilation.*

*Creating an affordable lighting pipe for maximum the use of sunlight sheded on the house for long hours during the day.*

*Orienting the windows in a way to promote cross ventilation as a replacement for air conditioners.*

*Designing the main entrance in L-shape and locating the private rooms at the back of the house for conserving the local culture and traditions of keeping the privacy of the family and segregation between females and males.*

*Designing a beautiful yet robust palm tree trunk ceilings, matching with the layout of Kershef building and also as a material for climatic responsive zero carbon emission material.*

*Encouraging social interaction among the family members by providing central gathering areas.*

*Encouraging interaction among the members of the society by providing outdoor sitting area for men 'khos'.*

### Shali Lodge and its extension Al Baben Shali

Shali Lodge and its extension Al Baben Shali were constructed as the first eco-tourism lodges in Siwa. Shali lodge is situated few meters from the village in Siwa and built with the local Kershef. Interestingly, no electricity was used. The building technique adopted relied mostly on best utilizing the available resources. For instance; both buildings were built with Kershef and the interior walls exposed to the sun were painted in light colors for emitting solar radiations. Also, open air atrium between the rooms has been created for passive ventilation, where we can see wide opening arches are surrounding the atrium for enhancing the wind speed. Alcoves were grooved on the walls for storage or decorative purposes inspired by the old Siwan vocabularies. Very important, since the project determined construction using the local materials, was to establish a contracting company for kershef to carry out the building work where not many Siwans were skilled for the task. As a result, further demand in kershef building techniques occurred afterwards; creating more job opportunities for many Siwans. Due to a project management of this building awerness between locals was raised, land reclamation was significantly limited by agriculturalists to become 25,000 acres after it was from 250,000 while also water depletion was prevented.



### Shali and Albabin Shali lodges helped achieve:

*Enhancing passive cooling via separating the building with narrow alleys for creating wind currents, besides cross ventilation replaced the use of air conditioners.*

*Promoted the awareness of less energy consumption among the society.*

*Workshops for the community to raise the awareness for climatic responsive architecture, as a result land reclamation was significantly limited for instance.*

*Encouraging local trades inspired by the traditional building techniques like constructing a Kershef factory, and palm tree roof construction for creating more job opportunities to the society.*

*Creating a new and unique practice of dehydrating the salt furniture and lighting units inspired by the best utilization of the natural environment.*



# architecture

SOURCE: L. Rovero, U. Tonietti, F. Fratini, S. Rescic research paper  
**The salt architecture in Siwa oasis – Egypt (XII–XX centuries)**  
Dipartimento di Costruzioni, Università di Firenze, Italy  
ICVBC, Firenze, Italy

## Building techniques

*The spring waters are used to irrigate the palm and olive plantations and are then drained into the salt lakes. Nevertheless more and more deep wells have been drilled in recent years causing a rise of the water table which now is close to the surface level. This upraise causes the formation of wide-spread salt efflorescences on the topsoil, on walls of buildings and on rock outcrops as well.*

### The constructive features of Shali

The abandon of Shali dates back to the thirties of the 20th century, only few remains are left like the shreds of the big and articulated city walls, in really bad condition of conservation compared to what represented in the few pictures and drawings of the travellers of the past century. Today the citadel looks like an incredible succession of ruins, walls that rise up isolated to be about to fall down, houses that can be distinguished only by few crossing of walls and little windows. In this context some remains of the city walls stand up moulded according to the morphology of the hill and giving rise to a wavy strip that makes them so evocative. It is evident that unfortunately the whole complex is in an unstable equilibrium with continuous movements due to external actions like rain water and rock falls along the slopes of the hill. Such accidents seem to be hindered by thin walls, often damaged, all of them realised with a masonry based on salt blocks "kersheef", bounded a salty mud.

### MATERIAL \_ KARSHEEF

An unusual material made of NaCl salt crystals with impurities of clay and sand. The blocks of irregular shape taken from the salt crust that surrounds the salty lake, are cut in smaller blocs and utilised in the masonry with a mud mortar very rich in salt obtained from two different clays, tafla or tiin. During the drying process of this particular kind of mortar, a strong connection is established between the salt blocks and the mortar due to the crystallisation of NaCl inside the mortar itself, giving rise to a sort of **monolithic** conglomerate. Kersheef blocks are directly extracted from the salt crust without any attempt of regularization. Their shape is similar to an irregular "ball" and they cannot be rectified because of its tendency to break. The building structures are realised through the assemblage of the different walls elements until completing the masonry boxes; within this organisation a leading role is played by the palm trunks which constitute the supporting structure of the floors at the different

levels and by other wood insertions (olive wood) with a function of connection.

### LOAD BEARING WALLS

Those of wide thickness with important **structural function**, mainly coincident with the outer walls of the citadel, are made by a badly ordered and selected internal nucleus of kersheef blocks, bound by a scanty mortar, and by two external facings. Such tall and strong kind of wall is larger at the base, where the width is almost 2 m, and decreases with the height. Often, when the external wall is close (and more or less parallel) to the back rock profile, a variation occurs: only the outer regularized "brickwork" can be observed while the internal nucleus and the necessary filling material are quite undistinguished inside.

Those characterised by a prevalent **partition role**. Their width is smaller (between 30 and 60 cm); they are made by quite homogeneous size karshif pieces, cemented with abundant salty mud mortar. In such walls the constructive technique is simplified;

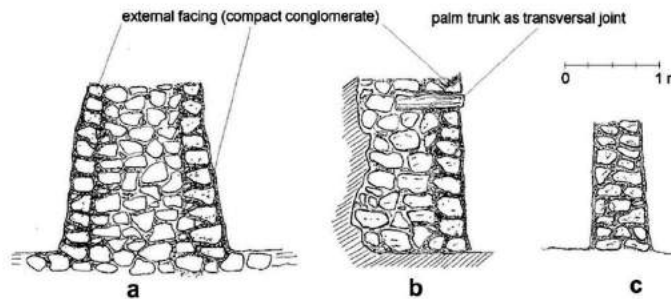

Different typologies of wall: wide thickness (a, b) and partition wall (c)

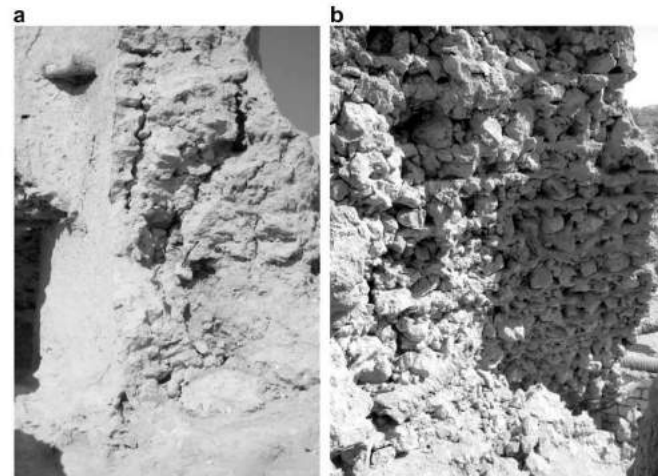

Whenever an outer wall is founded at a lower level than the trample level (normally the first storey level is some meter taller) we can observe a succession of breaches opened into the walls, mostly in correspondence of the corners–edges, from which a lot of debris comes out formed by irregular karshif pieces, placed inside the walls as filling materials. The Siwan building technique has internal frailties that came to light starting from the abandon of the citadel and the masonries were exposed to unexpected and injurious actions.

A further element that let us identify the hearth of the problem is the recurrence – inside the great supporting walls – of wooden pieces or trunks, plentifully distributed and therefore certainly essential in the stability strategy pursued by Siwan masons.

### WOODEN INSERTS

Beams and rods laid along the wall surface. They are utilised with the aim to aid and to structure the changing in curve direction of the walls from convexity to concavity both in the horizontal and in vertical direction jointing the different wall portions. In the case of different orientation between the lower and the higher parts, it is possible to obtain a rise of curved surfaces and consequently to conquer strength by shape.

Wood inserts laid inside the wall thickness in order to improve the jointing between the external and the internal parts, especially where the walls are wide (in this case with the function of transversal joints).

*Both typologies of wood inserts can be observed in the undulated wall located near the North Door of the fortress.*

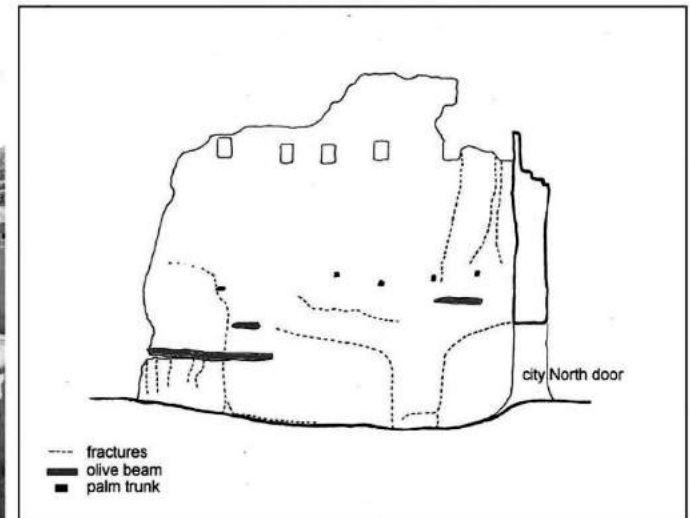



An observation of the external surface of the wall made it possible to evaluate the recurrence of such uses, the importance of the insertion of transversal joints, the different static role assigned to different wood types (the olive tree with a more structural task, i.e. as a beam, while the palm tree with a constructive task).

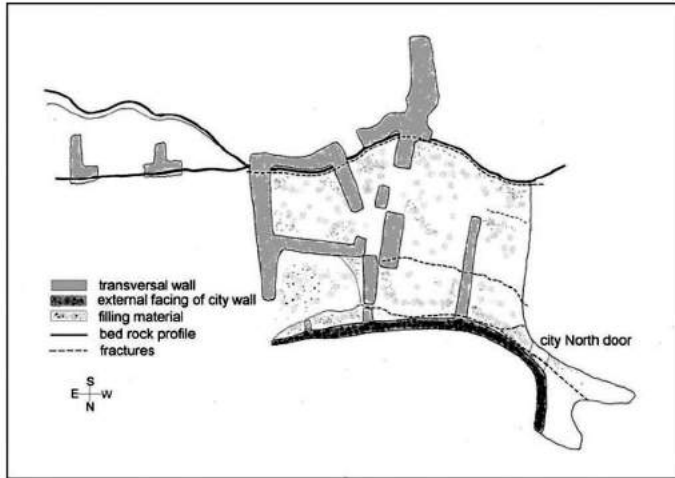

### The constructive features of minor buildings

Brittleness of siwan buildings (fractures of bulfings are spread everywhere within historic town) should be considered as a part of the structural system. First concerns is the use of wooden beams, their efficiency and their relation with the masonry walls. It is well known that **palm wood** is a very deformable material and it exhibits great vertical displacements even in presence of small loads. frequently palm is used with its trunk separated longitudinally into two halves, in order to employ the halves turned out in respect to the original symmetry axe. This kind of setting makes it easy the laying of the upper plank floor. Nevertheless the elastic movements might be heavy in this case too, as pointed out by the constant presence of fractures under the point of support in the wall. However the most interesting remark concerns the cracks pattern distribution. Very often the orthogonal walls are detached near the corners.

We must remember that the wall are made by mixing karsheef blocks (in irregular pieces) and salty mud. One of the concerns, that can not be regulated is drying up time of the mud. this mortar quickly hardens and crystallises, at most the setting can be delayed wetting the masonry. The discontinuities are a problem; in fact, whenever there is a stop in the construction site (due to the different phases of the building process), an interruption shall occur.

### cracks - origin and consequences

*The cracks due to a loss of the filling material in the large external Shali walls. In such event a lot of joint-causes play a role: some movements of the bed rock that thrust on the walls; the loss of cohesion of the internal filling material due to the exposition to rain; the collapse of some transversal walls that represented an important restraint for the remaining structure.*

*The cracks noticed near the corner-edges. They are possible because there is a real building weakness near the corners of the box. The different phases of building process that make impossible a strong joint where a discontinuity, of time or space, occurs. In order to avoid such discontinuities wooden rods are employed.*

*The cracks under the palm beam or near a concentration of load. These fractures are a consequence of the loss of specific loads distribution devices.*

At the end of the constructive process a building is only apparently a monolithic structure: behind the external crystallised surface there are inside conglomerate blocks joined in different ways. A good quality (and duration) of the joint depends on the quantity of salt mortar that penetrate into the hollows: it shall be excellent for the vertical superposition but very poor for the horizontal discontinuities.

### materials of architecture

Following materials can be found: *salt blocks* utilised as ashlars, *salty mud mortar*, *palm and olive tree trunks*.

The salt blocks, called **karsheef**, are made of NaCl crystals with a little amount of clay and sand and are taken from the shore around the salty lakes. They are evaporitic deposits which form through precipitation of NaCl and other



*Fractures under the palm beams in the walls.*

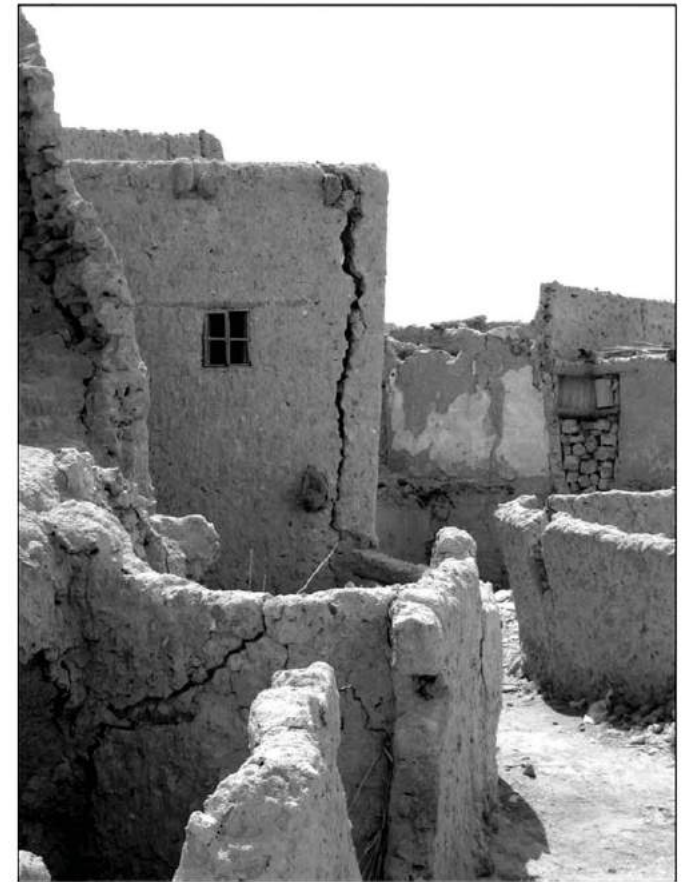

the salty lakes. During this process, in occasion of sandstorms, minerals like quartz, feldspar calcite and clay minerals can be included as impurities in the salt.

Until the XIXth century the masonry mortar was realised utilising tiin as binder, an **argillite** present in layers inside the Mamura Formation of Miocene age. This formation outcrops extensively on the hills around and inside the oasis. The argillite, in the outcrop, is characterised by a brown greenish colour and by the presence of levels and fissures filled by gypsum crystals. Exactly these levels rich in gypsum were selected to produce the mortar as testified by the aspect of the old masonries the argillite was disaggregated in salty water for about 10 days in order to rehydrate and to acquire a plastic behaviour. At present in the traditional karsheef architecture the mortar is realised with **tafla**, a clay that can be found under the salt crust around the salty lakes. This clay is mixed with salty water until reaching the suitable workability and utilised directly without adding aggregate.

# architecture

SOURCE: Nicola Scardigno

## Toward an A Priori Sustainable Architecture

Politecnico di Bari, Department of Science and Civil Engineer  
<http://www.mdpi.com/2076-0752/3/1/15/htm>

### A priori concept of sustainability

The idea of eco-sustainability represented by practices of "urban greening", that nature can camouflage architecture represents new ideological scheme in "experimental urban aesthetics". The contemporary model of environmental sustainability seems as a stereotyped discipline, where the design process is materialized through standardized ideology and technology, that produce universal architecture. A priori model of sustainability aiming to preserve, through dutiful upgrading, the language and identity of place. A model that recognizes formal connections between building products and environment

*"It is representative of an adaptable sustainability, where both typomorphological and technological choices evolve, in the form of upgrading, from an inherited technical-constructive knowledge."*

Such an idea of "adaptive sustainability" allows one to enhance a designer's critical-interpretative skills and, so, to develop building production characterized by a multiplicity of alternatives. In other words, the idea of sustainable research aimed to obtain energetic performances through generalized and ahistorical architectural solutions contrasts with **the complex task of experimenting with the practice of sustainable design by considering notions of "time" and "place"** (i.e., a body of customs and norms acquired over the course of building within a specific geographical context).

The urban regeneration of Siwa Oasis should not refer to standardized and expensive technological equipment, but rather to those resources (material, social, cultural and economic) that the oasis still offers today. Essentially, the upgrades were aimed at simplifying the building methods and encouraging the possibility of generating a new productive activity through reduced forms of aggression within the environment.

*The invitation is to search for sustainable strategies within a repository of anthropic data stratified within specific cultural areas.*

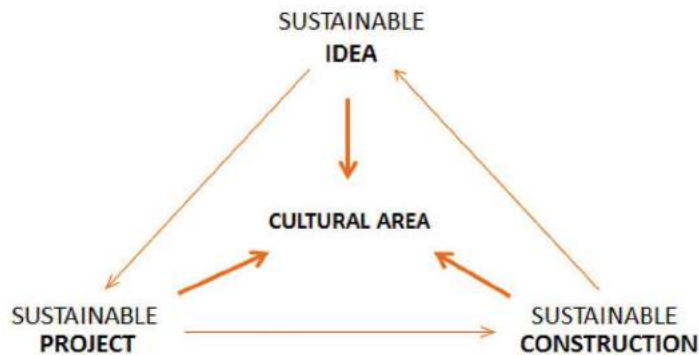

*Studies of the construction techniques adopted within the Siwa Oasis (authors: Calvano S., Loconte P., Pizzolante S., Ricuperi P. and Vitulli A.).*

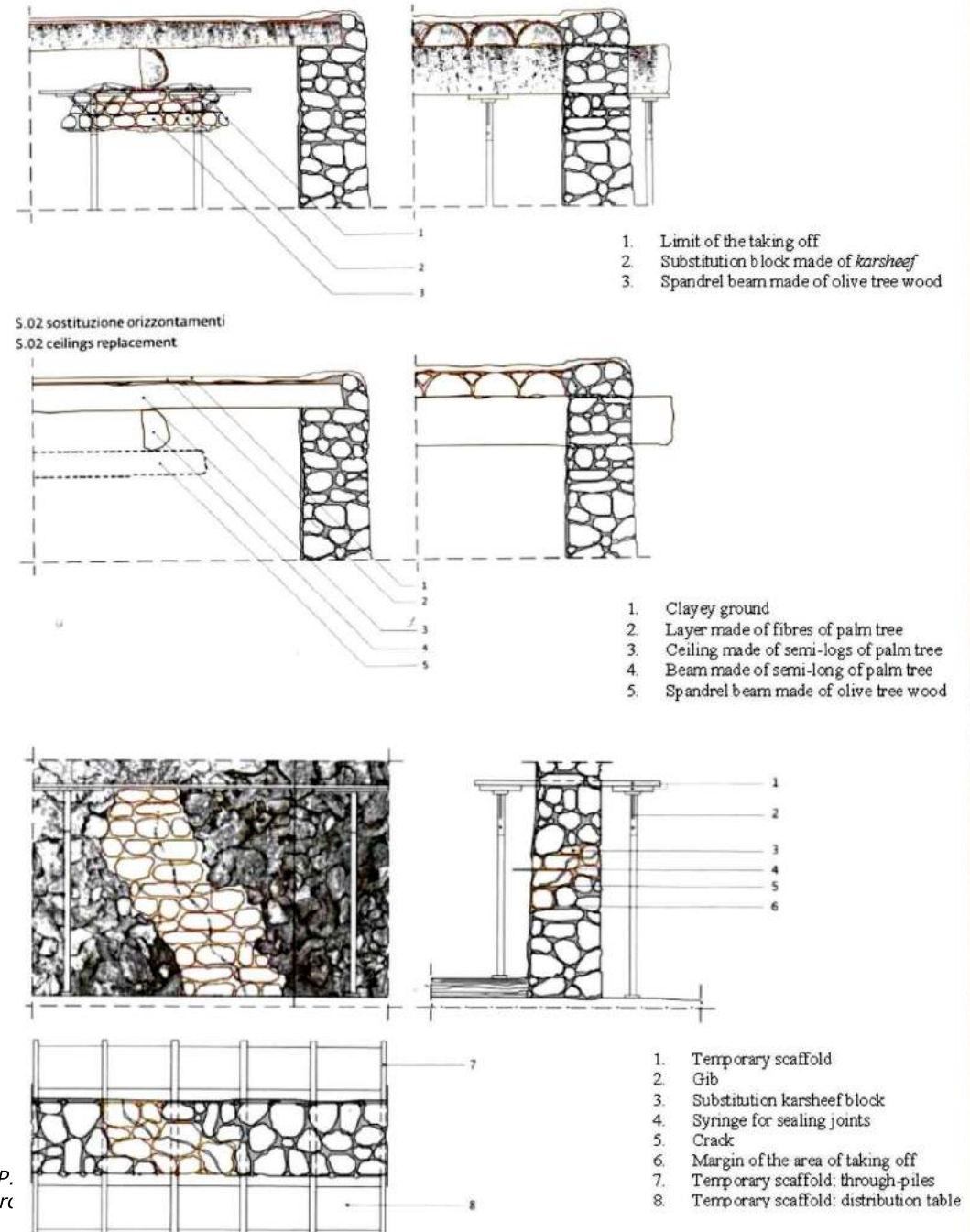



# architecture

SOURCE: R.M. Ahmeda research paper

## Lessons Learnt from the Vernacular Architecture of Bedouins in Siwa Oasis, Egypt

The Bartlett School of Graduate Studies, University College London, UK



### Adreere Amellal eco-lodge

Amellal eco-lodge is considered one of the main touristic eco-lodges in siwa. It is located in a unique place surrounded by sculpted limestone, 75 acres of palm and olive trees, salt rocks and clay, aimed to best use the available local building materials available in the surrounding environment. The hotel is at the edge of the lake Siwa in the western desert. Windows were designed to be very small in size and imbedded in the very thick Kershef walls. Similar to the previous buildings, climatic responsive materials were used, passive cooling and cross ventilation were achieved for better climatic conditions. The building was built at the foot of the mountain in order to build on non-arable ground and to appropriately coat the arrangement in a manner that merges the mountain with the building.

The building is characterised with its furniture, made with the local materials of sand blocks, various Kershef patterns, unique sky light roof made of palm tree trunks blended with sand blocks, and furniture carved from palm tree trunks. The floors are built with stone.

*Sky light roof made of palm tree trunks blended with sand blocks ||| The small windows imbedded in the thick walls*



it has been reported (Hatem T. Siwa Sustainable Development Initiative) by a Siwan that the EQI projects has respected Siwa's culture, norms, and nature. Moreover, it used modern technology to enhance the past; referring to not using electricity which was done intentionally to make travelers experience night time and day time to allow them to go back to the natural rhythm of life, and feel harmony with nature. A better quality of life was provided to the people, including: simple, clean, good food, and fusion of state of being, that makes Siwa a unique enterprise. According to Abou Adel, marketing coordinator of the Siwa Initiative, Siwa was one of the poorest communities in Egypt where over 90 percent of its people were involved in agriculture, and the rest in tourism. Not until the EQI eco-lodges encouraged the local people to be engaged in other activities related to tourism. , Siwan women were given opportunities to gain employment, a prospect that was previously unheard of in the male-dominated society.

*Local material in Siwa is cheap, naturally available in large quantities in the surroundings, durable, when applied correctly, having good thermal mass capacity for insulation and having beautiful surfaces as a finishing materials.*

### Lessons according to R. M. Ahmed

*Using the local availabilities in the building site yield the most appropriate building isolative properties for achieving thermal comfort*

*Using technology in adopting vernacular architecture vocabularies helps achieving climatic responsive innovations in the building construction filed.*

*Explaining to the local people the actions that benefit the earth compared to what may be damaging to the environment enhances climatic responsive building techniques, best utilization of the local available materials, and the creation of low-cost zero carbon building techniques.*

*Engaging the community in environment awareness programs promotes a better quality of living from all aspects of life.*

*Transforming the sustainable development project scope in the low income communities in to a business model would significantly enhance the economic status of the poor.*

*Limiting the use of air conditioning to be replaced by natural ventilation methods achieves cheaper and a more energy-saving conventional alternative for climate control.*

On the upper floor, bedrooms are located with a central living area in which the family member gather, eat and discuss the family issues. Besides, the bedrooms are separated in to roofed rooms for sleeping in winter and non-roofed for sleeping in summer to replace the use of any mechanical modes for cooling during the hot summer. On a similar basis, another un-roofed kitchen is located on the upper floor in addition to the one in the ground floor. The upper kitchen 'Tabent' is actually the one sued for cooking, equipped with a built-in Kershef cooker for minimising the use of electricity as well. house was built first with 50 cm high concrete wall on the ground floor level, which is not costly to build for isolating the ground water from the Kershef blocks. Then they determined the areas of the room and afterwards they started building with the thick Kershef blocks until they reached the desired height. They repeated this for each single room. Following, they supported their walls with palm wood trunks connections on roofs to achieve straight endings of the building's walls, which was used as decorative element for interior design as well.

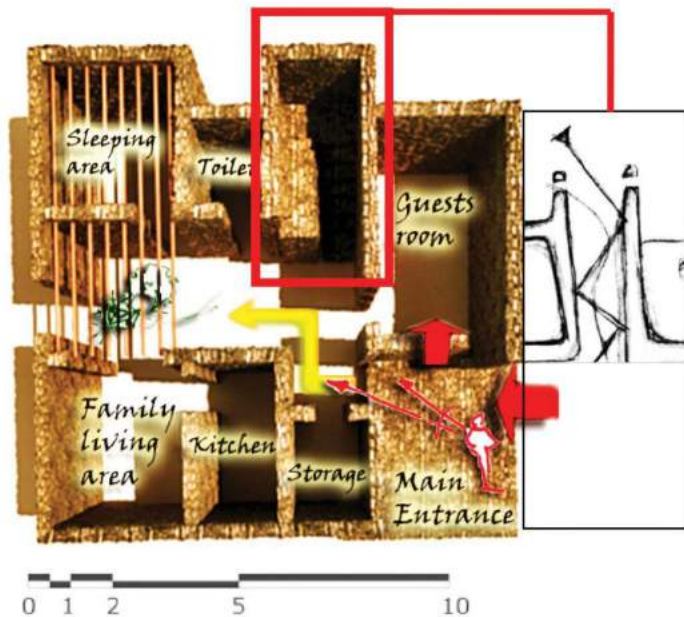

Left: Ground floor plan of Haj Ali house comprises of: L-shape entrance, 1 guest room, 2 storage, family living area, open roof sleeping area, toilet and a stair case leading up stairs to the bedrooms

Right: the stair case acting as a lighting pipe

### low cost climatic responsive building techniques adopted by the traditional Siwans' houses

*Best utilisation of the local material for climatic responsive zero carbon emission building, while using the local material for building the cooker to minimise the electrical devices.*

*Using the stair case tower as an atrium for passive ventilation.*

*Creating an affordable lighting pipe for maximum the use of sunlight sheded on the house for long hours during the day.*

*Orienting the windows in a way to promote cross ventilation as a replacement for air conditioners.*

*Designing the main entrance in L-shape and locating the private rooms at the back of the house for conserving the local culture and traditions of keeping the privacy of the family and segregation between females and males.*

*Designing a beautiful yet robust palm tree trunk ceilings, matching with the layout of Kershef building and also as a material for climatic responsive zero carbon emission material.*

*Encouraging social interaction among the family members by providing central gathering areas.*

*Encouraging interaction among the members of the society by providing outdoor sitting area for men 'khos'.*

### Shali Lodge and its extension Al Baben Shali

Shali Lodge and its extension Al Baben Shali were constructed as the first eco-tourism lodges in Siwa. Shali lodge is situated few meters from the village in Siwa and built with the local Kershef. Interestingly, no electricity was used. The building technique adopted relied mostly on best utilizing the available resources. For instance; both buildings were built with Kershef and the interior walls exposed to the sun were painted in light colors for emitting solar radiations. Also, open air atrium between the rooms has been created for passive ventilation, where we can see wide opening arches are surrounding the atrium for enhancing the wind speed. Alcoves were grooved on the walls for storage or decorative purposes inspired by the old Siwan vocabularies. Very important, since the project determined construction using the local materials, was to establish a contracting company for kershef to carry out the building work where not many Siwans were skilled for the task. As a result, further demand in kershef building techniques occurred afterwards; creating more job opportunities for many Siwans. Due to a project management of this building awerness between locals was raised, land reclamation was significantly limited by agriculturalists to become 25,000 acres after it was from 250,000 while also water depletion was prevented.



### Shali and Albabin Shali lodges helped achieve:

*Enhancing passive cooling via separating the building with narrow alleys for creating wind currents, besides cross ventilation replaced the use of air conditioners.*

*Promoted the awareness of less energy consumption among the society.*

*Workshops for the community to raise the awareness for climatic responsive architecture, as a result land reclamation was significantly limited for instance.*

*Encouraging local trades inspired by the traditional building techniques like constructing a Kershef factory, and palm tree roof construction for creating more job opportunities to the society.*

*Creating a new and unique practice of dehydrating the salt furniture and lighting units inspired by the best utilization of the natural environment.*



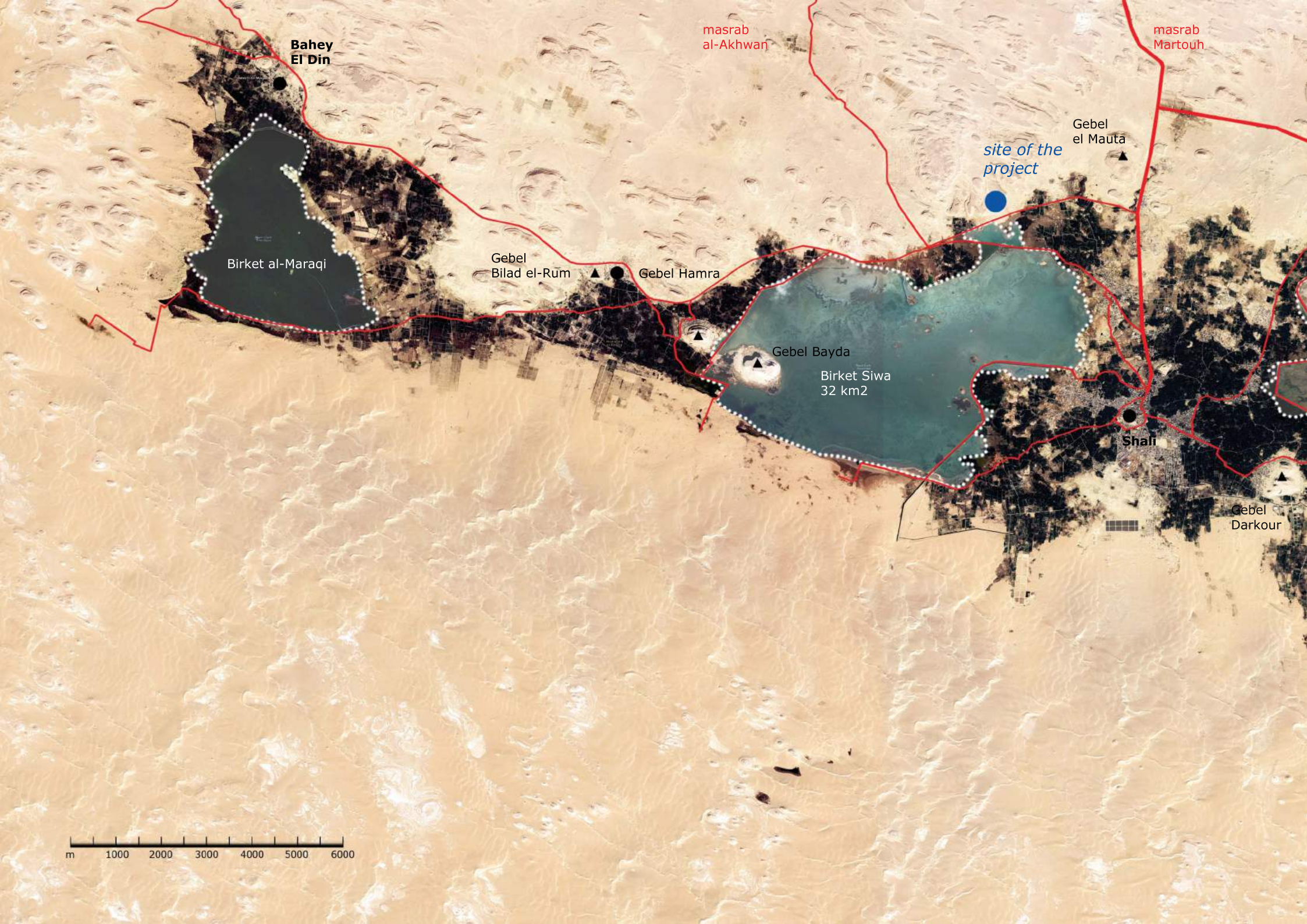

Bahey El Din

masrab al-Akhwan

masrab Martouh

site of the project

Gebel el Mauta

Birket al-Maraqi

Gebel Bilad el-Rum

Gebel Hamra

Gebel Bayda

Birket Siwa  
32 km<sup>2</sup>

Shari

Gebel Darkour

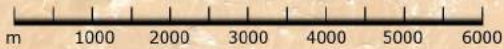

Siwa-Al Wahat-Al Baharyia road

Quruysat

Birket Zaytun  
16 km<sup>2</sup>

Birket Azmuri  
often dry

Abu  
Shuru

Sabkha = salt flat



# Shali

SOURCE: Nicola Scardigno

**Toward an A Priori Sustainable Architecture**

Politecnico of Bari, Department of Science and Civil Engineer  
<http://www.mdpi.com/2076-0752/3/1/15/htm>



 servizi services	 residenziale housing	 strutture sanitarie health structures	 solo artigianato only handicraft	 moschee mosques	 scuole schools	 strutture turistiche tourist structures	 commerciale residenziale commercial housing
 strutture militari military structures	 strutture sportive sport structures	 mazhalla mazhalla	 strutture sociali social structures	 specialistici specialistic	 stalle sheds	 artigianato residenziale handicraft housing	

uses





 struttura in karshif  
 Karshief structure

 struttura in tobe  
 Tobe structure

 struttura in mattoni  
 Brick structure

 struttura intelaiata  
 in c.a.  
 Framed structure  
 made of c.a.e.

 struttura intelaiata  
 in tobe  
 e tamponatura in  
 mattoni  
 Curtain wall made  
 of tobe and bricks

 struttura intelaiata  
 in c.a. e  
 tamponatura in  
 tobe e mattoni  
 Framed structure  
 made of c.a.e. e  
 curtain wall made  
 of tobe and bricks

 struttura intelaiata  
 in c.a. e  
 tamponatura in  
 tobe  
 Framed structure  
 made of c.a.e. and  
 curtain wall made  
 of tobe

 struttura intelaiata  
 in c.a. e  
 tamponatura in  
 mattoni  
 Framed structure  
 made of c.a.e. and  
 curtain wall made  
 bricks

 struttura intelaiata  
 in tobe e  
 tamponatura in  
 karshif  
 Framed  
 structure made of  
 tobe and karshief  
 curtain wall

**construction technology**

# Shali

SOURCE: Nicola Scardigno

**Toward an A Priori Sustainable Architecture**

Politecnico of Bari, Department of Science and Civil Engineer  
<http://www.mdpi.com/2076-0752/3/1/15/htm>



**number of floors**

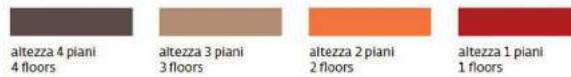

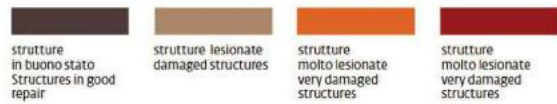

**condition**



05

## technology

SOURCE: Sada Yoosathaporn, Poon Tiangburanatham & Wasu Pathom-aree  
**The influence of biocalcification on soil-cement interlocking block compressive strength**  
<http://popups.ulg.ac.be/1780-4507/index.php?id=12179>

### Biocalcification

Biomediated processes that have been investigated for their influences on geomechanical properties include mineral precipitation, biofilm formation, use of biopolymers, mineral transformation, and biogenic gas production. natural cementation of geological formations through mineral precipitation occurs constantly over time owing to physicochemical and microbiological reactions.

*These microbially mediated reactions result in relatively insoluble compounds that can contribute to soil cementation.*

Biocalcification also known as microbiologically induced calcite precipitation (MICP), is a normal biochemical process that naturally occurs in many environments such as sea water, fresh water and soil. During this process calcium carbonate accumulates due to the activity of urease-producing microorganisms. Calcium carbonate precipitation occurs in nature when the concentration of calcium ion, and/or carbonate ion increases. Precipitation can be induced by physical processes such as changes in temperature or pressure or by the activities of microorganisms.

#### Urease

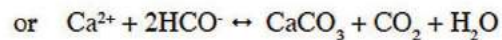
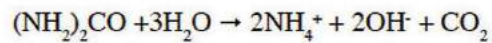

Urease hydrolyzes urea to carbonate and ammonium ions that increase the pH in an environment. Calcium carbonate precipitation occurs when  $\text{Ca}^{2+}$  is present in the environment.

There are reports on the use of biocalcification for repairing the surface of the stone and cement concrete. In addition, some ureolytic bacteria were able to improve the properties of concrete such as increased compressive strength and decreased permeable property. These resulted in an increasing resistance to degradation of cement mortars, bricks, conventional red bricks. Recently, urease producing bacteria was used for concrete strength improvement and as concrete deteriorating mold inhibition agent.

*The biocalcification process, especially with use of urea as a microbial substrate, has been successfully implemented in the laboratory for improvement of sands and plugging of fractured rocks*

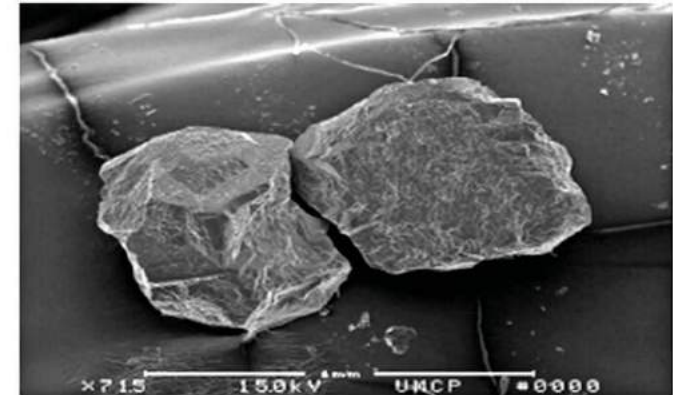

(a)

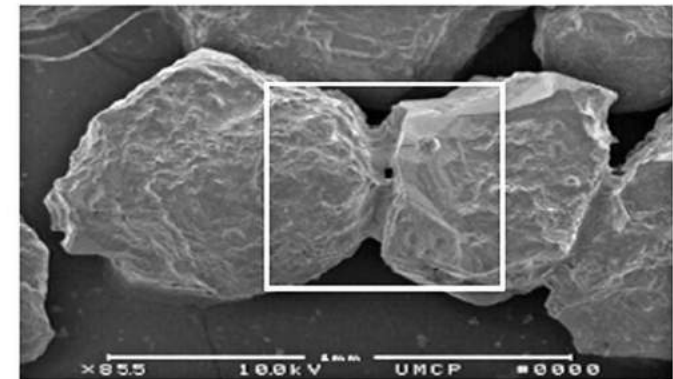

(b)

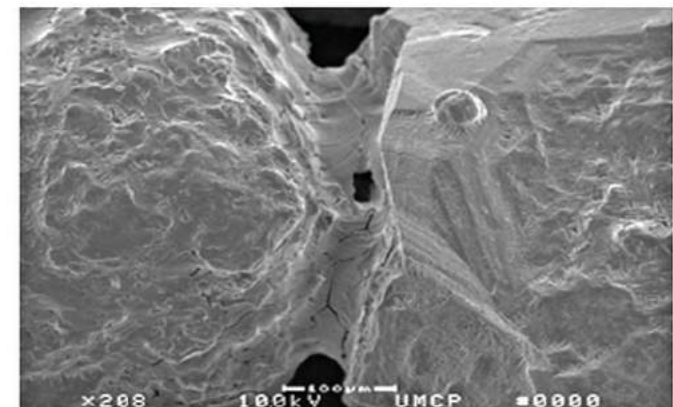

(c)

- (a) untreated sand with pretreatment  
(b) biocemented sand without pretreatment  
(c) focus on the area within the square boundary in panel (b)

## Bricks from sand

Treating the bacteria right requires feeding them which is where the urine comes in – urea [ $(\text{NH}_2)_2\text{CO}$ ] can be made synthetically or from urine, and provides nutrition for the bacteria. Water is also necessary, as is calcium chloride. Bacteria can solidify sand to any imaginable shape such as bricks.

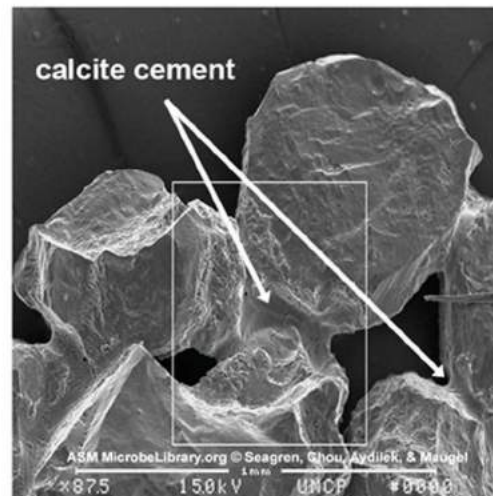
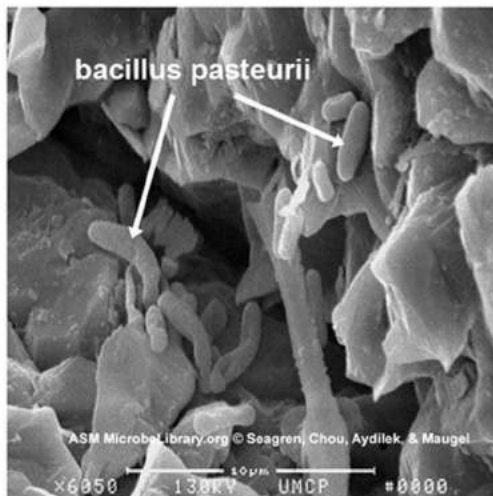
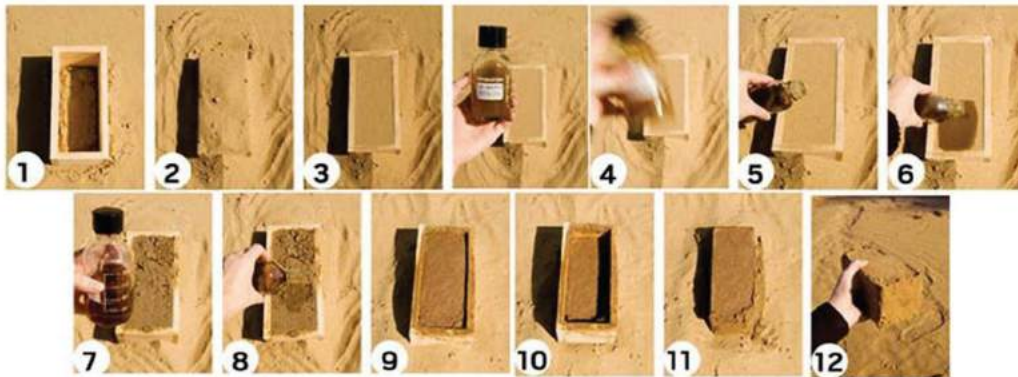
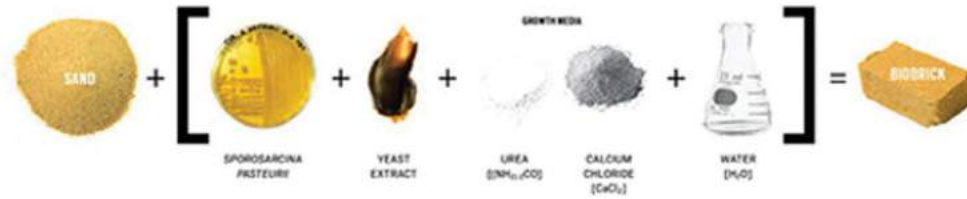

# technology

SOURCE: **Vitrified sand**

[https://en.wikipedia.org/wiki/Vitrified\\_sand](https://en.wikipedia.org/wiki/Vitrified_sand)

## Vitrified sand

It is sand that has been heated to a high enough temperature as to partly melt the silicon dioxide or quartz that is the main ingredient of common sand. When sand is used to make glass, soda ash or potash are added to lower the melting point. Pure quartz melts at 1,650 °C (3,002 °F). There are several natural processes that produce more or less melted sand and one man-made form:

### Fulgurites (1)

They are formed when lightning strikes the ground, fusing and vitrifying mineral grains. The peak temperatures within a lightning channel are known to exceed 30,000 K, with sufficient pressure to produce planar deformation features, or "shock lamellae" in SiO<sub>2</sub> polymorphs. The primary SiO<sub>2</sub> phase in fulgurites is lechatelierite (*a silica glass.*) Because their groundmass is generally amorphous in structure, fulgurites are classified as mineraloids (*mineral-like substance that does not demonstrate crystallinity.*)



(1) fulgurite



(2) Tektite

### Tektite (2)

It is gravel-size bodies composed of black, green, brown or gray natural glass formed from terrestrial debris ejected during meteorite impacts. They generally range in size from millimeters to centimeters.

### Trinitite (3)

It is the glassy residue left on the desert floor after the plutonium-based Trinity nuclear bomb test on July 16, 1945, near Alamogordo, New Mexico. The glass is primarily composed of arkosic sand composed of quartz grains and feldspar (rock-forming silicate minerals) that was melted by the atomic blast.



(3) trinitite

### Frit (4)

A frit is a ceramic composition that has been fused in a special fusing oven, quenched to form a glass, and granulated. The purpose of this pre-fusion is to render any soluble and/or toxic components insoluble by causing them to combine with silica and other added oxides. However, not all glass that is fused and quenched in water is frit, as this method of cooling down very hot glass is also widely used in glass manufacture. In recent centuries, frits have taken on a number of roles, such as biomaterials and additives to microwave dielectric ceramics. Frit in the form of aluminosilicate can be used in glaze-free continuous casting refractories.



(4) frit



**Mechanical Properties of Vitrified Soils**

https://digitalcommons.unomaha.edu/civilengfacproc/8/?utm\_source=digitalcommons.unomaha.edu%2Fcivilengfacproc%2F8&utm\_medium=PDF&utm\_campaign=PDFCoverPages

**Mechanical Properties**

**Soil Vitrification Experiment**

The soil vitrification experiments were conducted at the plasma arc torch facility of Georgia Institute of Technology in Atlanta, Georgia. A 100-kW and a 240-kW non-transferred plasma arc torch were used in the experiments with a high-temperature (4000°C~7000°C) plasma plume directed at the target soil.

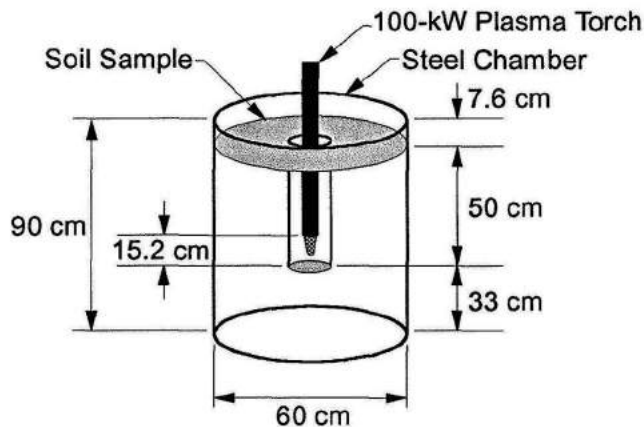

The dimensions of the experiment setup

The torch was raised 5.1 cm every 10 minutes during the test for approximately a one-hour duration. Piedmont silty sand, kaolin clay, and Tyndall AFB beach sand were successfully vitrified into homogeneous monoliths. Each monolith was cut and cored with the intent to provide as many test specimens as possible. **The 5.1-cm cubes** were cut with a circular diamond blade. **10.2-cm long cylinders** were cored by a 5.1-cm diameter diamond coring bit. (5)

**Instrumentation and Results**

*1. Elastic Modulus Measurements*

This measurement is performed by elastic wave propagation. Speed of wave in a homogeneous solid is related to the mass density  $\rho$  and elastic modulus  $E$ .

Three cylinders of weighed 444.9 g, 442.7 g, and 442.7g, This elapsed time measured for the three specimens was 16.9, 16.6, and 16.8 microSec. Thus the calculated elastic modulus for vitrified Tyndall sand was 77.8, 80.6, and 78.5 GPa, with an average of 78.9 GPa.

*2. 5.1-cm Cube Compression Tests*

Vitrified soils exhibit very brittle material behavior. Test specimens were generally pulverized at failure. The compressive strengths and averaged elastic moduli of the vitrified soil specimens are summarized in following Table 1.

*3. Split-Cylinder Tension Tests*

From the theory of elasticity, a cylinder compressed by diametrically opposite forces will develop compressive stress in that diametrical plane and tensile stress perpendicular to that plane. The computed ultimate stresses are summarized in Table 2.

table 1

Test No.	Vitrified Soil	Compressive Strength (MPa)	Ultimate Strain (%)	Elastic Modulus (GPa)
1	Tyndall sand	116.87	0.675	12.34
2	kaolin clay	116.41	0.103	100.0
3	Tyndall sand	152.14	0.156	29.52
4	Tyndall sand	19.81	0.278	8.00
5	Tyndall sand	50.88	0.100	50.48
6	kaolin clay	23.34	0.200	8.48
7	kaolin clay	39.87	0.106	47.72

table 2

Test No.	Compression at Failure (kN)	Tensile			Compressive		
		Stress <sup>a</sup> (MPa)	Strain (%)	Modulus (GPa)	Stress <sup>a</sup> (MPa)	Strain (%)	Modulus (GPa)
1	26.45	3.26	---	---	9.79	---	---
2	78.36	9.66	---	---	28.99	---	---
3	128.20	15.81	---	---	47.43	---	---
4	60.74	7.49	---	---	22.48	---	---
5	27.50	3.39	---	---	10.18	---	---
6	256.52	31.63	0.194	53.31	94.91	0.189	52.90
7	201.43	24.84	0.061	106.90	74.52	0.217	30.69
8	116.97	14.43	0.036	83.45	43.28	0.038	84.83
9	32.74	4.04	0.035	59.24	12.12	0.011	125.52

Potential applications related to pavement work include man-made high-strength aggregates, thermal stabilization of subgrade or subbase soil, and groundwater removal. The most critical factor for these applications is the power requirement. With a 3.5-MW power equipment to process soil at 5 tons per hour, it would take about 30 hours to have enough vitrified material to pour a 23-m wide, 30.5-m long, and 7.6-cm thick pavement surface.

In fact, the shear strength of common soils increases dramatically with temperature above 200°C and soil plasticity is reduced to zero at about 500°C. Therefore, plasma arc technology may be most cost effective if used for thermal treatment of certain types of soils in a continuous mode of operation.

(5) 5.1-cm Diameter Coring Bit and Vitrified Tyndall Sand





06

# DESIGN METHODOLOGY

## climate analysis

For the study of environmental performance of proposed project prevailing climate condition needs to be evaluated in relation of building optimization. Solar exposure a position needs to be optimized for heat reduction and heat gain. Prevailing wind direction needs to be evaluated for working ventilation and wind comfort. For this reason the geometric representation of a critical sun path and the prevailing summer and winter wind directions in the area were needed. The topography of the site and the built environment is critical in determining the movement of the wind in the area, to properly describe the prevailing wind directions, the development of a 3-dimensional wind grid has been considered of critical

importance. The wind grid that was developed is associated to both the topography of the site, and the geometry of the building.

To optimize the environmental performance of the structure, the main steps in the developed process were:

*The climatic analysis of the project and the development of a digital database of the local climatic features of the University of Patras area.*

*The development of a parametric model that joins the climatic analysis databases to the building geometry.*

*The development of an algorithm to explore the geometry of the building at hand. The algorithm utilizes the parametric model that joins the climatic analysis databases to the building geometry and to the site features.*

climatic analysis of the area, statistical data of the last ten years have been utilized. Data were downloaded for Kharga oasis and processed to create typical meteorological year. The Autodesk Ecotect software has been used for the conversion and the analysis of the data. The developed graphs with the assistance of the Ecotect Weather Tool display the prevailing climatic conditions

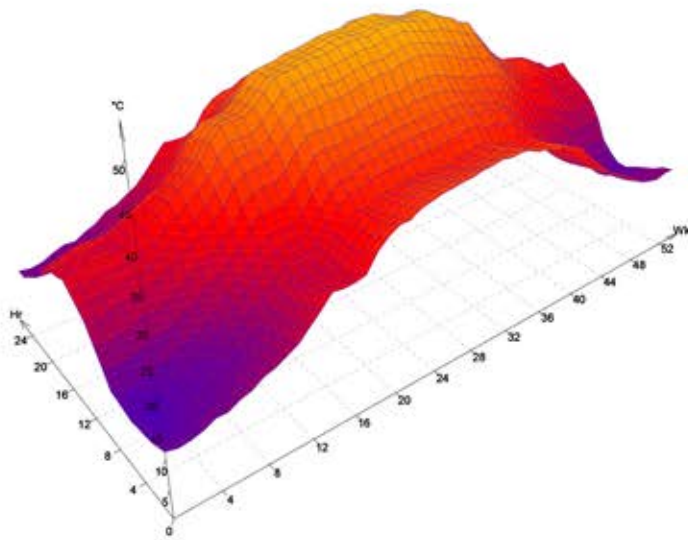

**average weekly temperature (°C)**  
contour range 0- 50 °C (steps in 1°C)

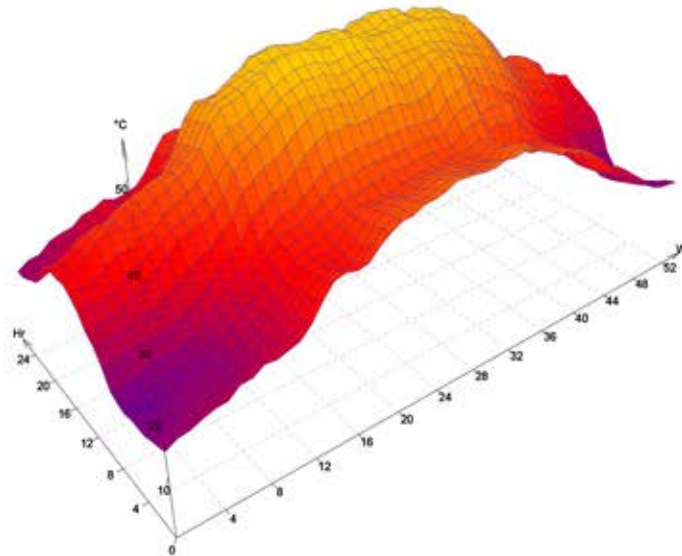

**maximum weekly temperature (°C)**  
contour range 0- 50 °C (steps in 1°C)

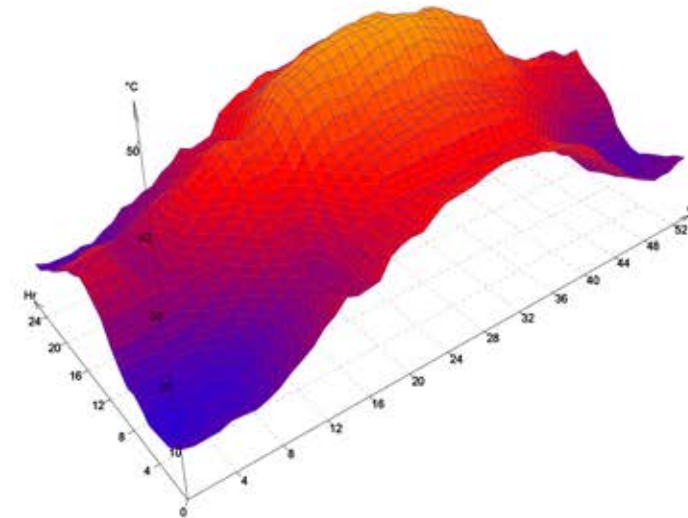

**minimum weekly temperature (°C)**  
contour range 0- 50 °C (steps in 1°C)

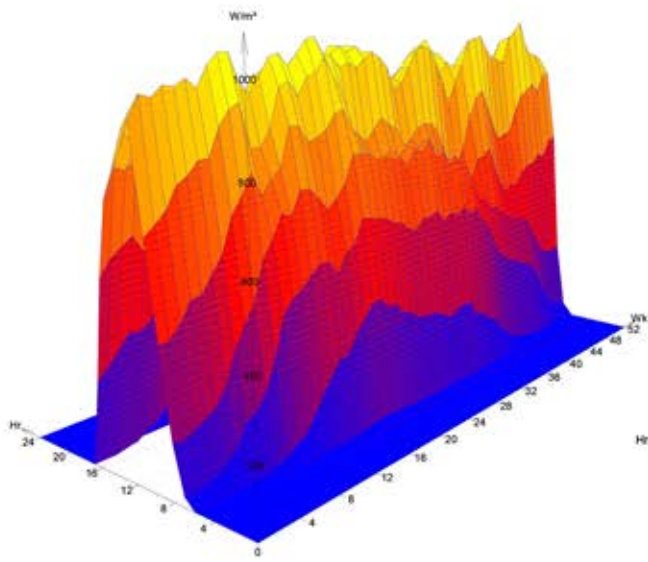

**direct solar radiation (W/m<sup>2</sup>)**  
contour range 0-1000 W/m<sup>2</sup> (steps in 20 W/m<sup>2</sup>)

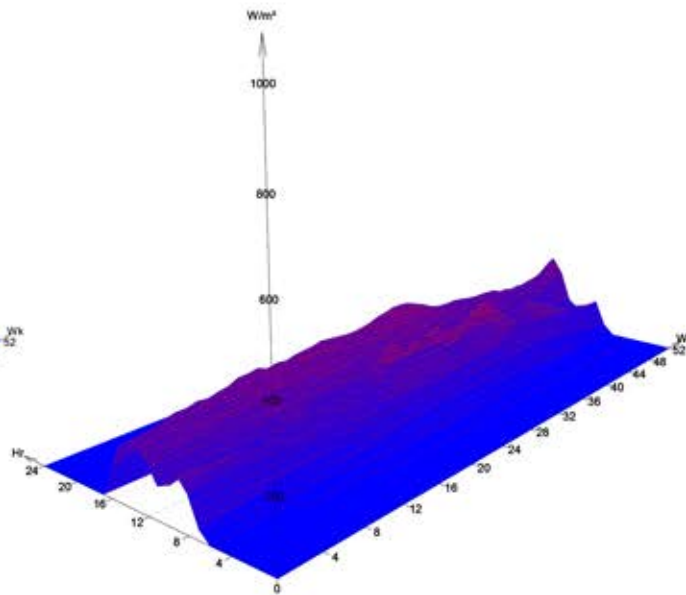

**difuse solar radiation (W/m<sup>2</sup>)**  
contour range 0-1000 W/m<sup>2</sup> (steps in 20 W/m<sup>2</sup>)

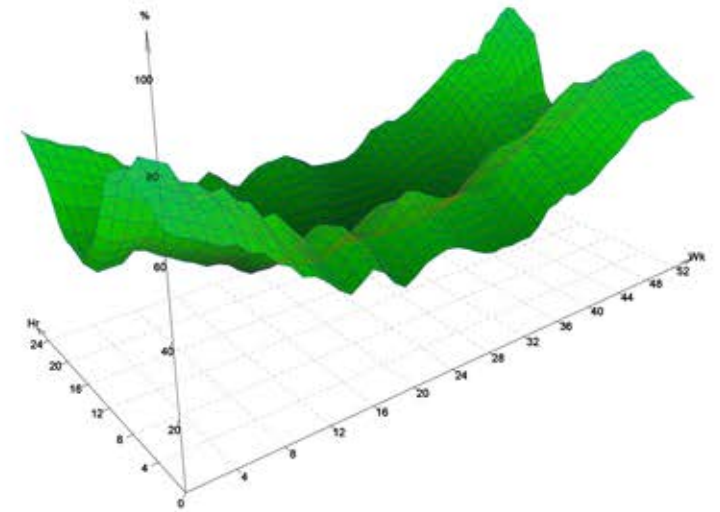

**relative humidity (%)**  
contour range 0-100 % (steps in 2 %)

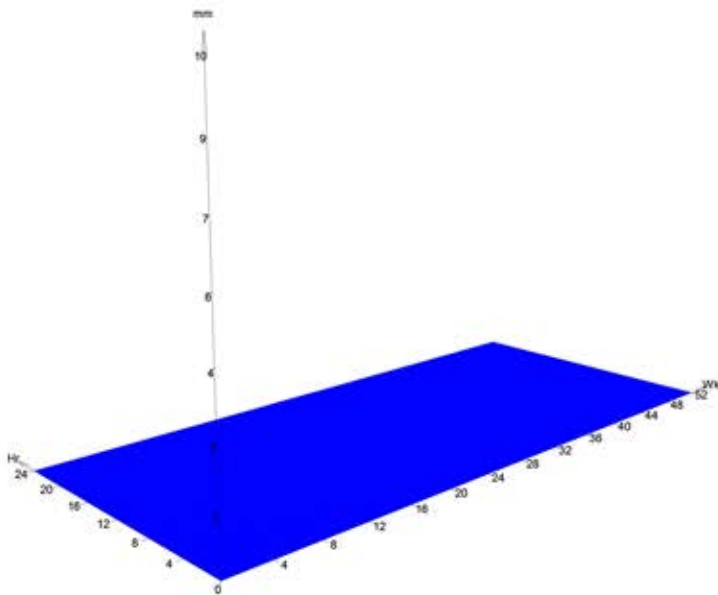

**average daily rainfall (mm)**  
contour range 0-10 mm (steps in 0,2 mm)

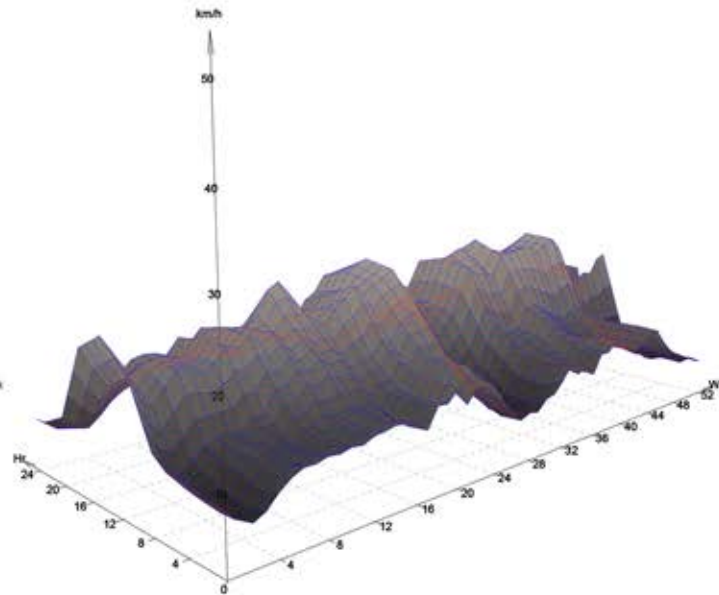

**average wind speed (km/h)**  
contour range 0-50 km/h (steps in 1 km/h)

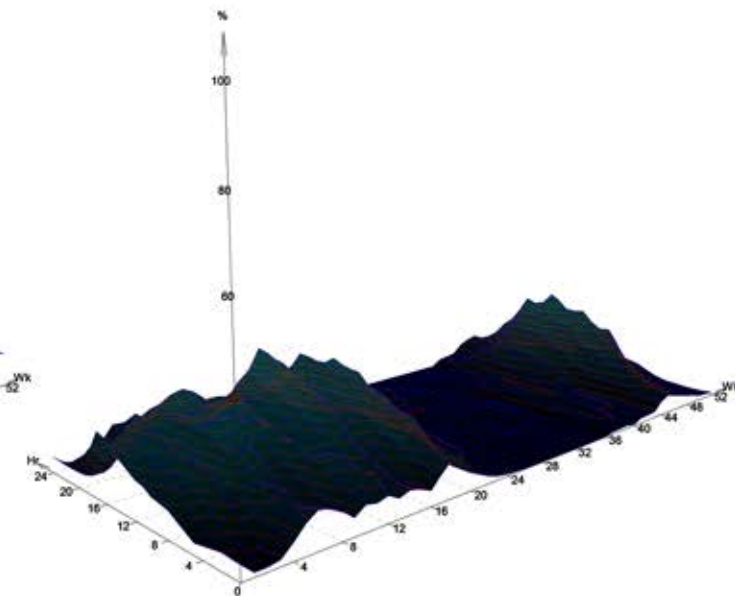

**average cloud cover (%)**  
contour range 0-100 % (steps in 2 %)

## DESIGN METHODOLOGY

### prevailing wind data

In the study presented in this thesis I attempted to develop a multi parameter model of the design project in which wind data would be a major parameter, to be considered. Wind data can be used during the architectural design process mostly through the application of appropriate Computational Fluid Dynamics (CFD) methods. The main goal that I wanted to achieve with the integration in the process of a CFD analysis was to enhance an understanding of the patterns of airflow on the site and their interaction with building volumes and envelope at a very early stage of the design process. Main effort was reduce heat gain and manage proper ventilation in the project and create decent living conditions

in desert environment, which are obtained by natural air flow system. Wind direction, wind speed and wind temperature are described by daigram. These diagrams have been analyzed and average wind speed and prevailing wind direction have established. The resulting data have been processed to create regular wind climatic conditions. The topography of the sites is also one of the input data that defines wind behaviour. From wind data and topography of terrain a CFD analysis the site was developed using Ecotect software and WinAir CFD module. The resulting data were air flow vector, air flow temperature and air flow speed. This data have been used for creating a parametric model, that adjusts to this behaviour.

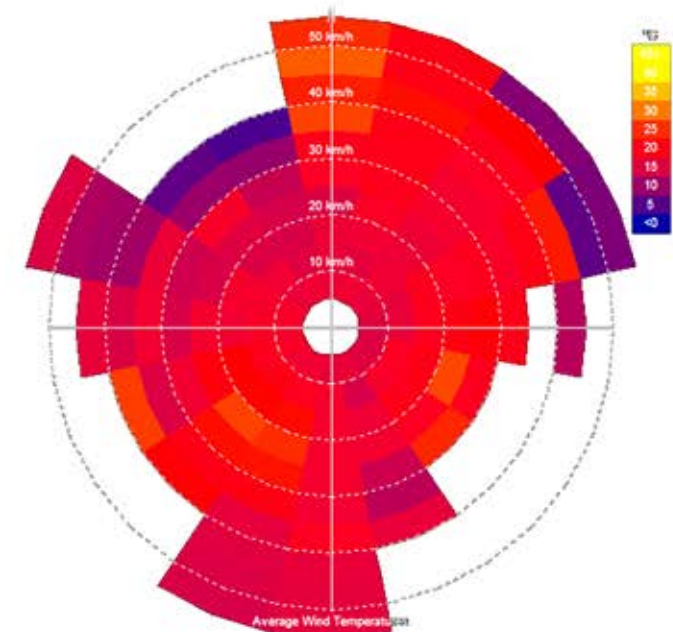

average wind temperature (annual)

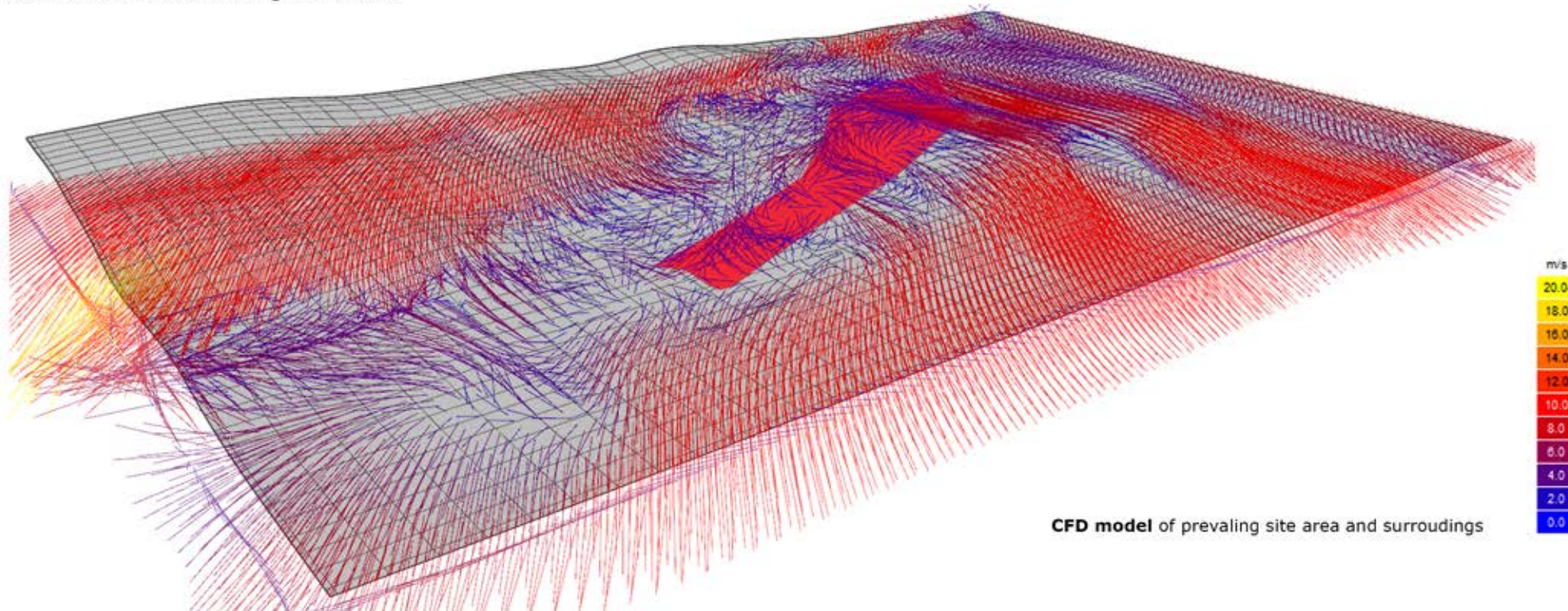

CFD model of prevailing site area and surroundings

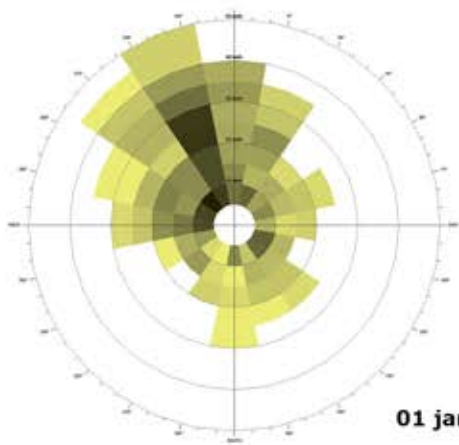

01 January

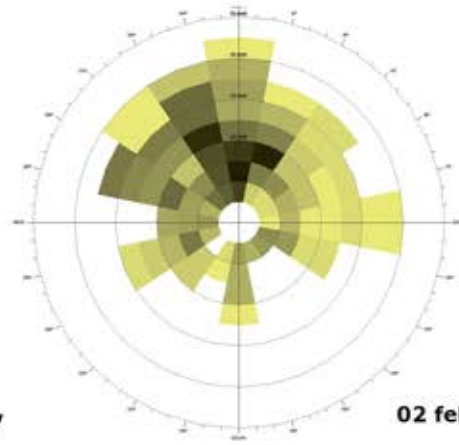

02 February

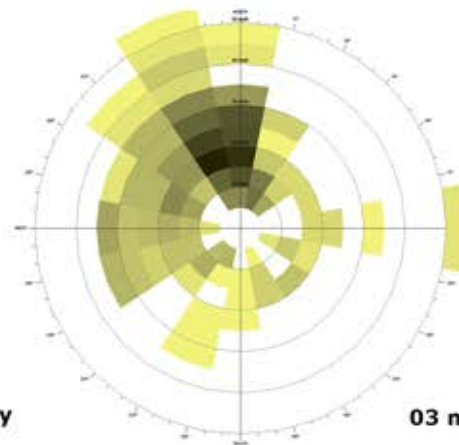

03 March

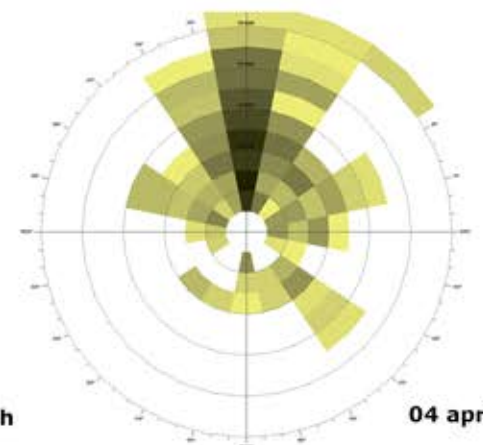

04 April

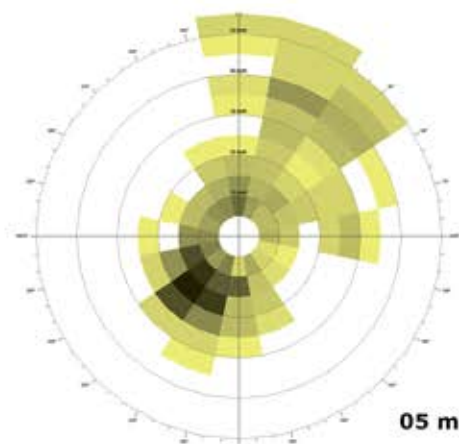

05 May

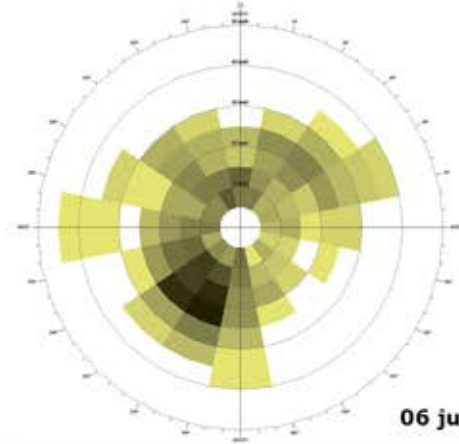

06 June

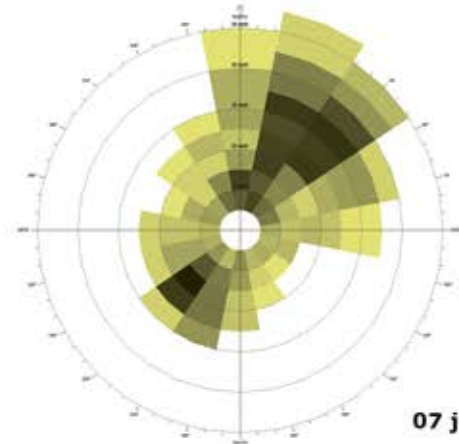

07 July

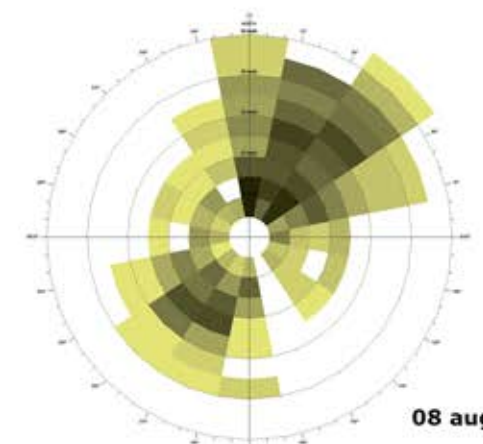

08 August

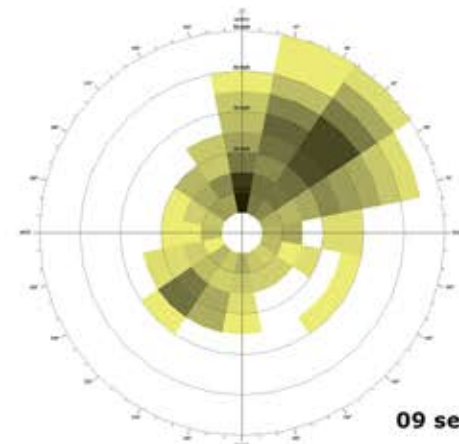

09 September

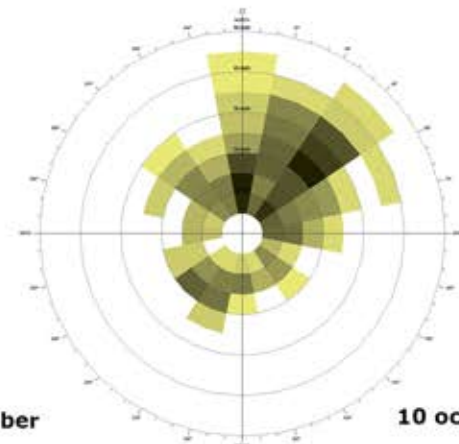

10 October

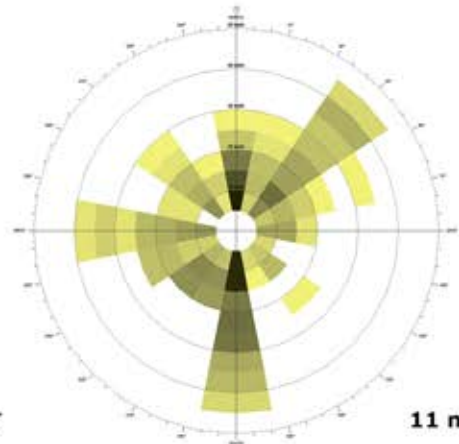

11 November

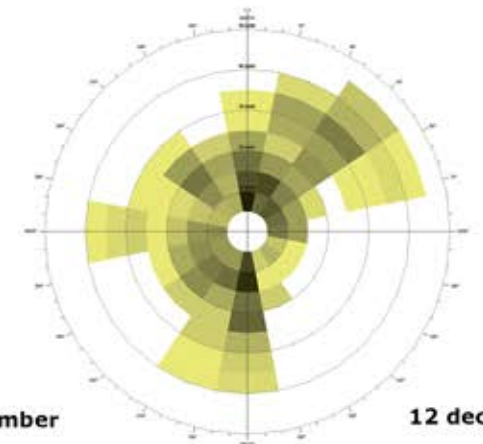

12 December

## DESIGN METHODOLOGY

### model evaluation

After Parametric model is defined by air flow parameters, functionality possibilities and aesthetic appeal, CFD evaluation is needed to see if result is capable to perform as planned. This evaluation is performed by layers. In every layer we can see, that low energy air flow vectors have direction towards structure intakes and high energy air flow vectors miss the structure altogether.

*The model conducts as a new terrain topography.*

1. layer was defined at elevation 2 meters above structure zero height. It is evaluation at terrain level. From CFD simulation we can see that high energy vectors avoid structure in all cases. Low energy vectors on the other hand lean towards structure intakes and leave the structure on the other side - **the simulation was successful**

2. layer was defined at elevation 35 meters above structure zero height. From this CFD simulation we can see how wind behaves at new structure topography.

**1. layer CFD simulation**

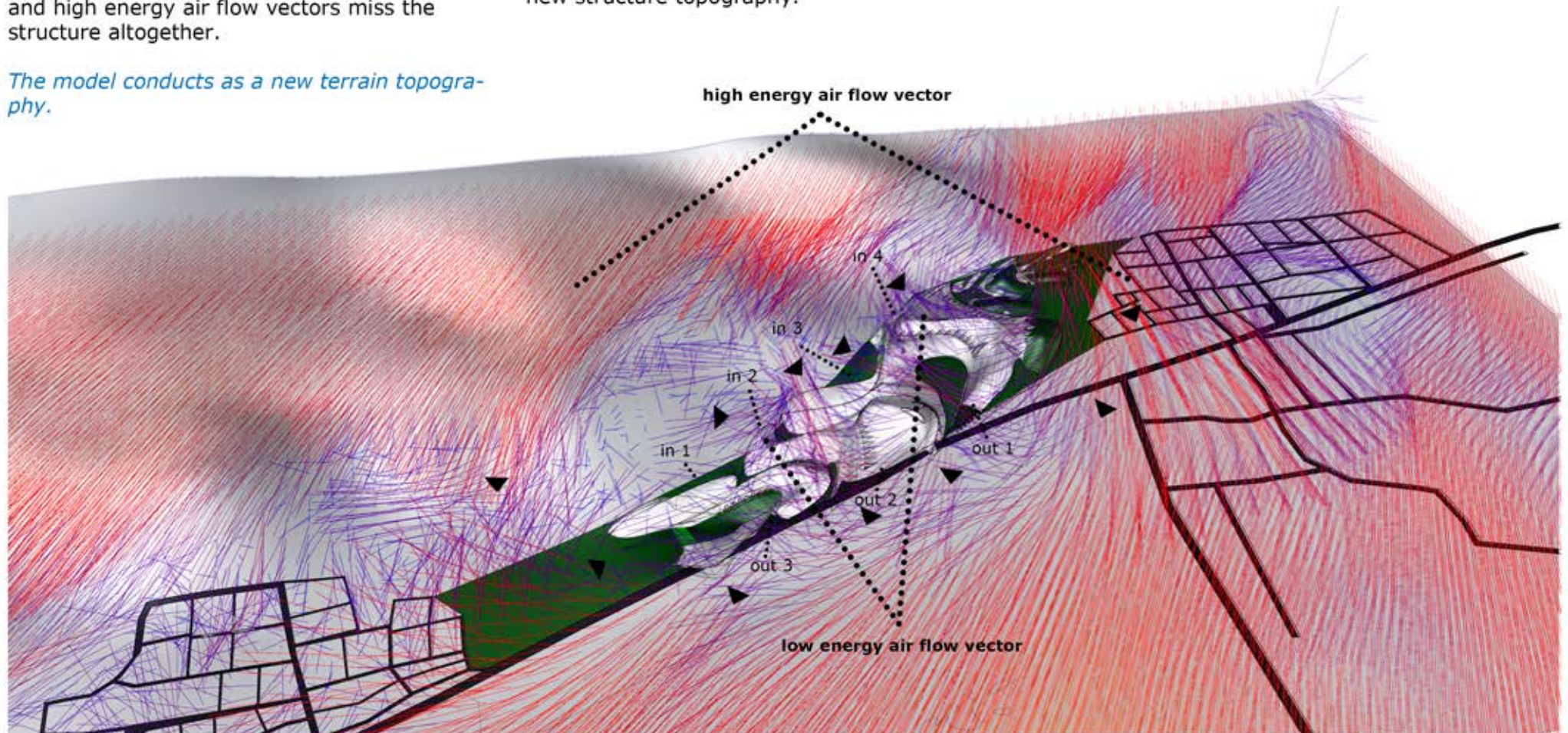



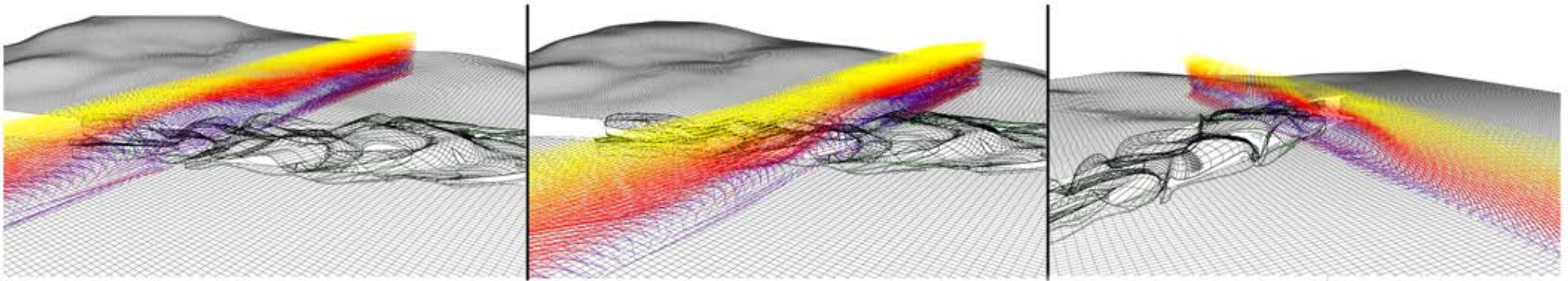

*cross layer evaluation*

*2. layer CFD simulation*

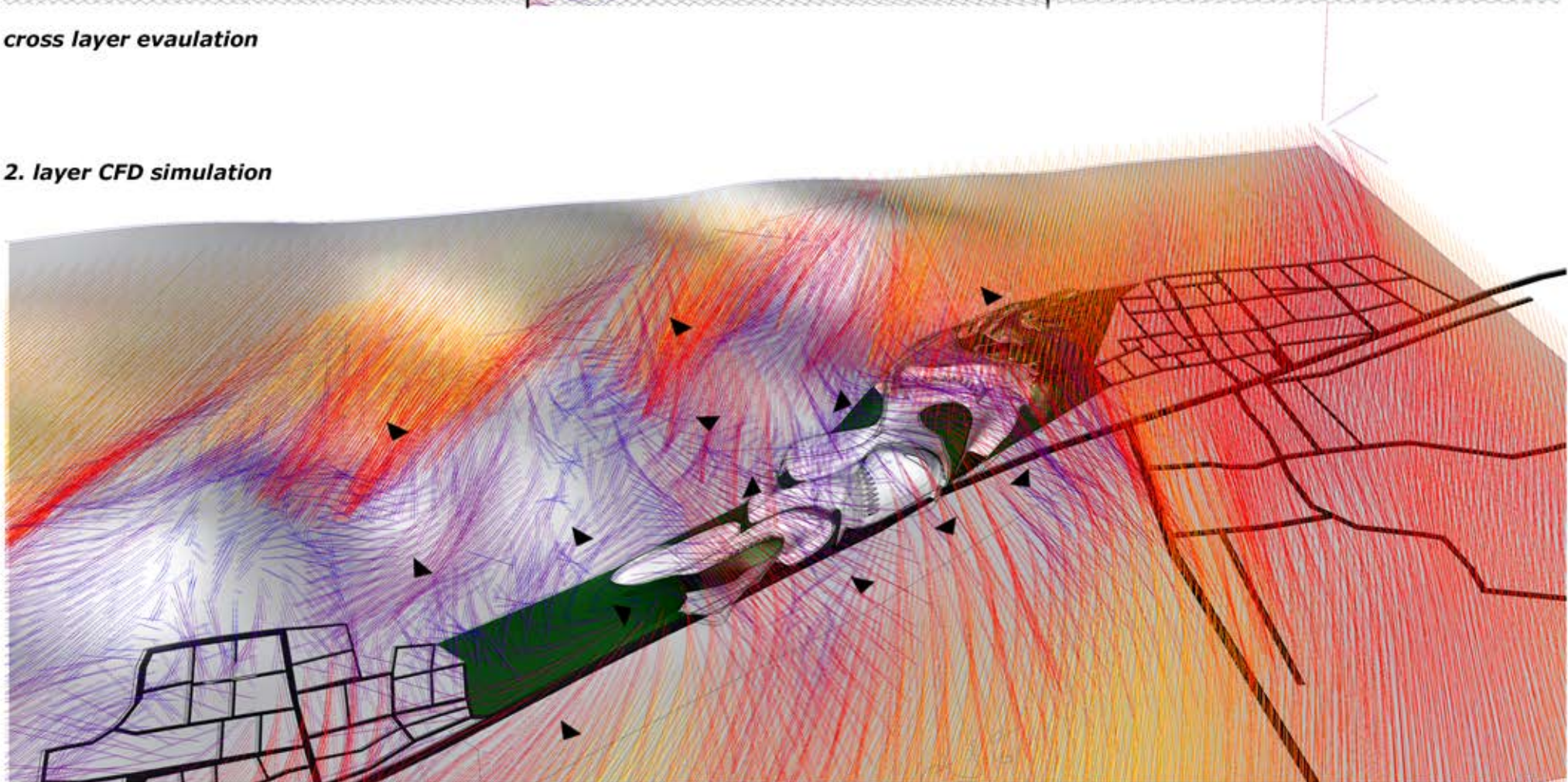

## DESIGN METHODOLOGY

### parametric model

CFD analysis of the site based on prevailing wind and site topography are main input data for creating a parametric model of the project. Flow vectors that are derived from CFD analysis are sorted and translated by importance of each vector in order to create stable environment. Vectors that have highest energetic value (highest air-flow speed and highest air flow temperature) are given null value (this have negative impact on the environment, speed of the air flow supports solid particles transfer such as dust and grains of sand, and temperature needs to be as low as possible). *Vectors with lowest energetic values are used for creation of new topography*, that reacts to the direction of a given vector.

The whole geometry of structure is designed in order to channel the air through the structure as easily as possible. Several scenarios have been created, analyzed and tested in order to define parameters, that creates more complex architectural structure:

#### 1. number of air intakes

Intakes should be regularly distributed, so the air flow balanced throughout the structure. These intakes are entrances into the architecture.

#### 2. height of the structure

It is the main engine that encourages air flow exchange thanks to stack effect (chimney effect), where warm air rises up and creates difference in the air pressure. This enables for cool air to enter in the lower parts of the structure.

#### 3. Number of cross directions

These directions are dependant on the air flow vector and support primary natural cooling effect, that has historical tradition in these parts of the world which is cross ventilation effect.

#### 4. internal subdivision

The subdivision of the surface for suitable internal living units. This controls the number and scale of internal spaces that can be altered for need of a community. Variety of this solution can differ from small single units to large block of units.

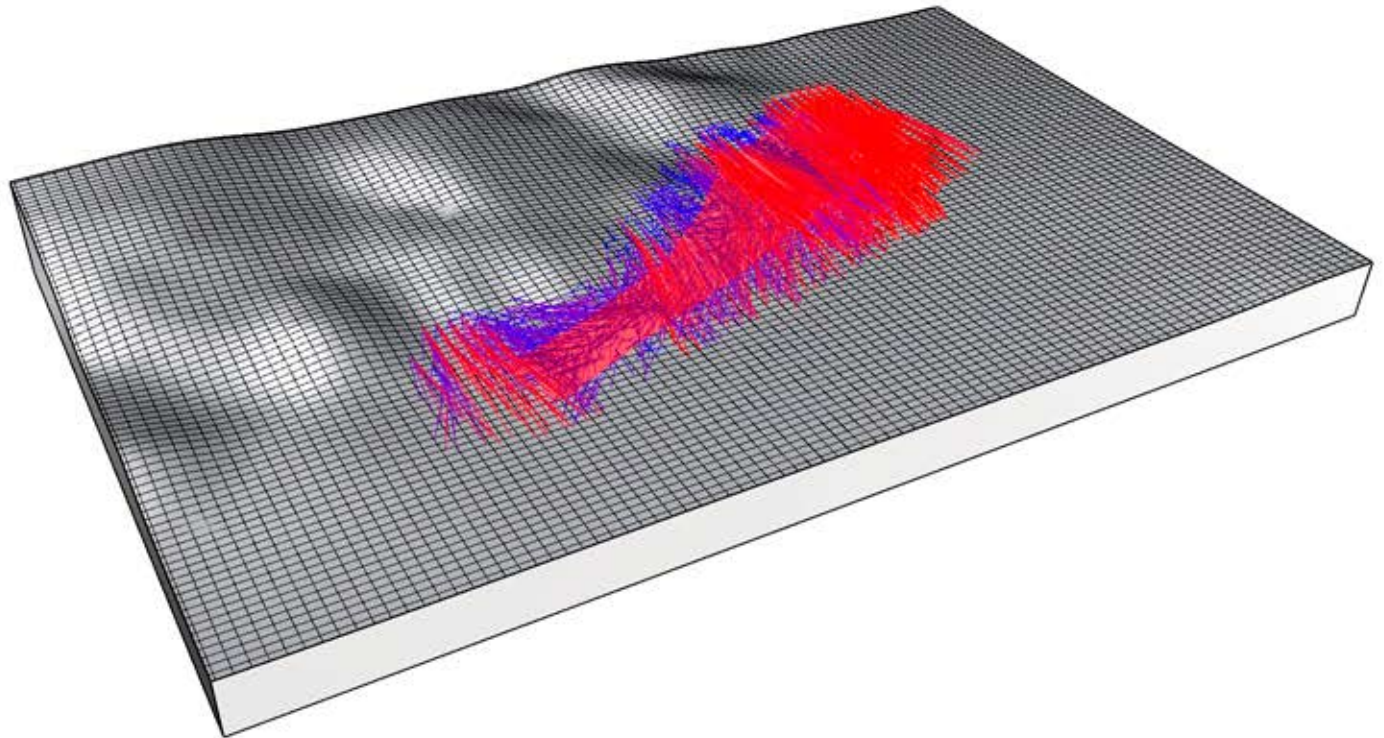

**INPUT DATA** - site topography and air flow vector

## testing scenrios

### vector selection

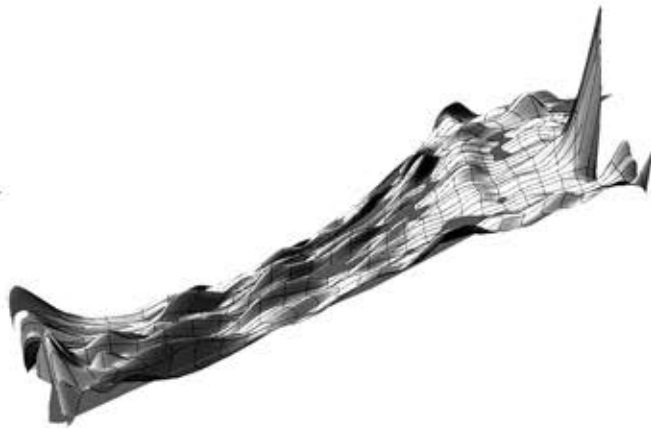
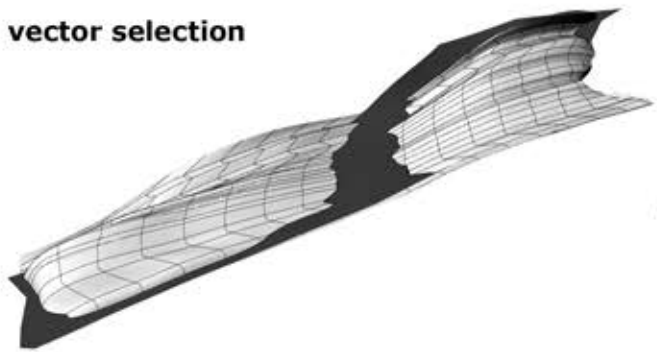

### intakes and cross direction

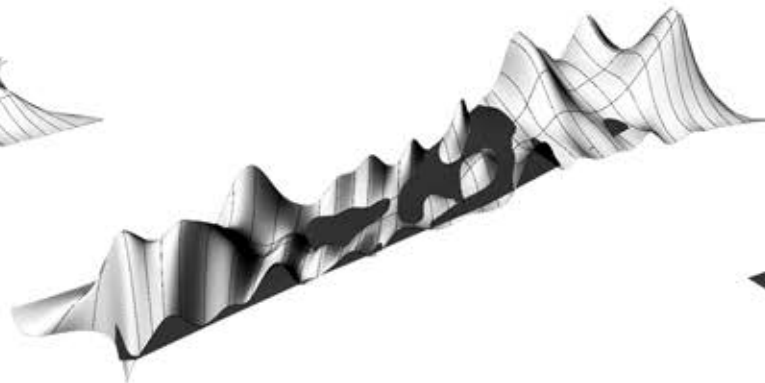
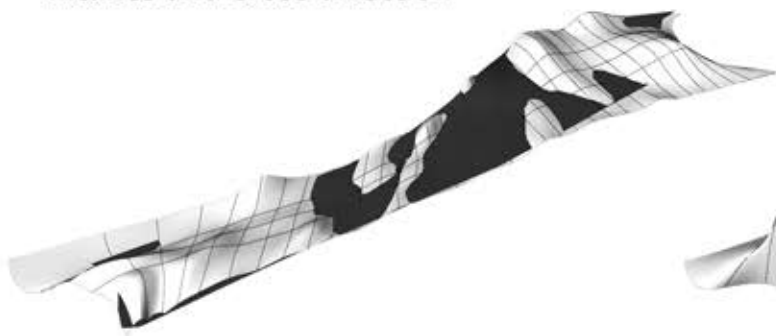

### internal sudivision

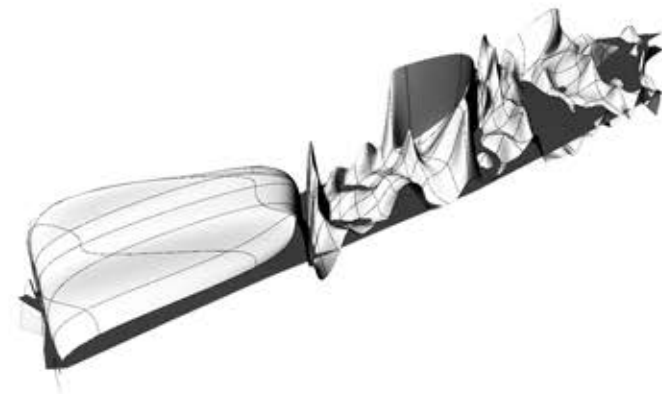
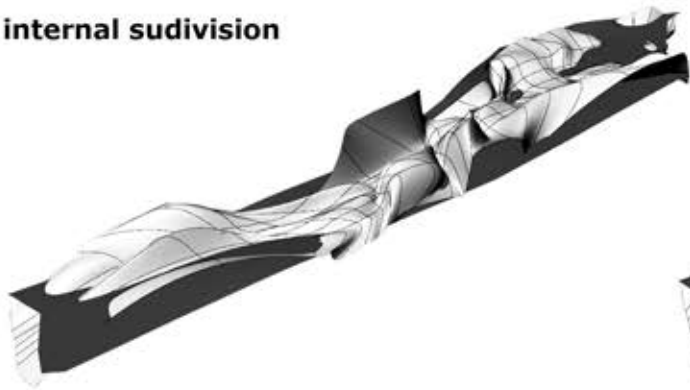

# DESIGN METHODOLOGY

## scheme of design

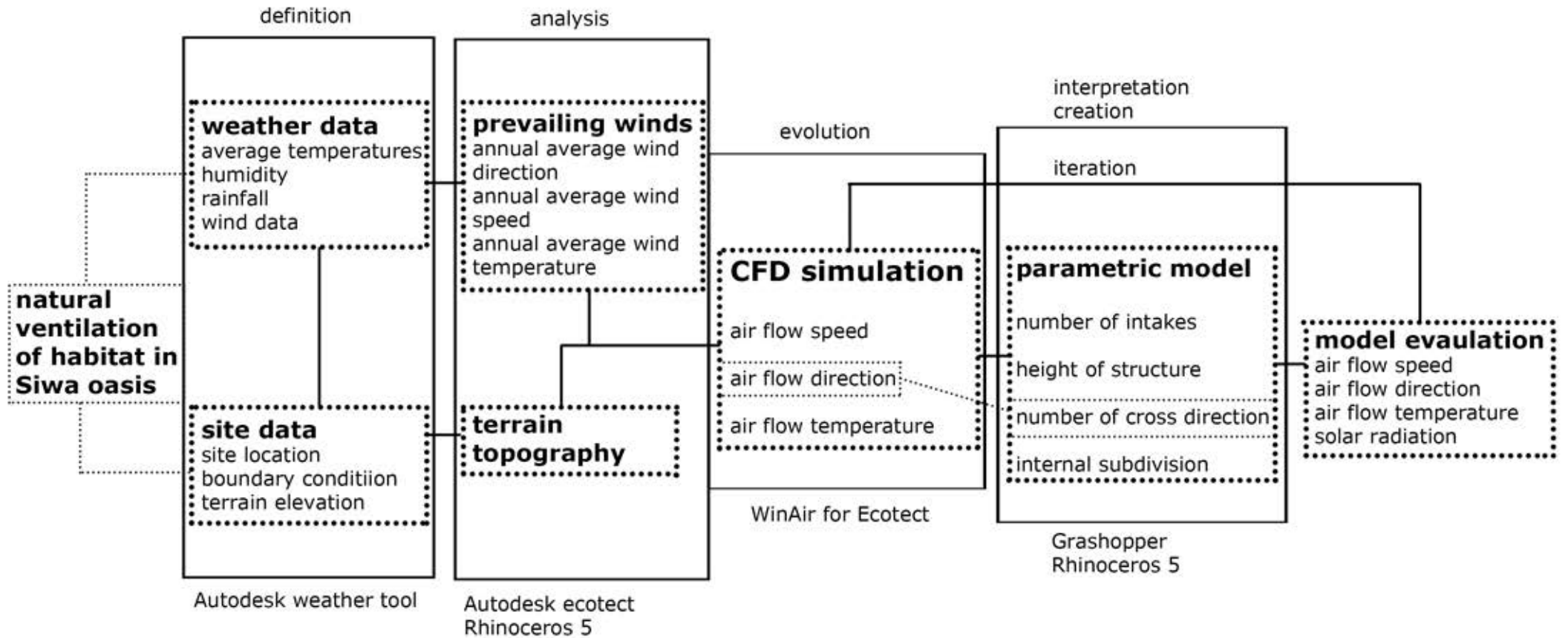

**resulting structure**

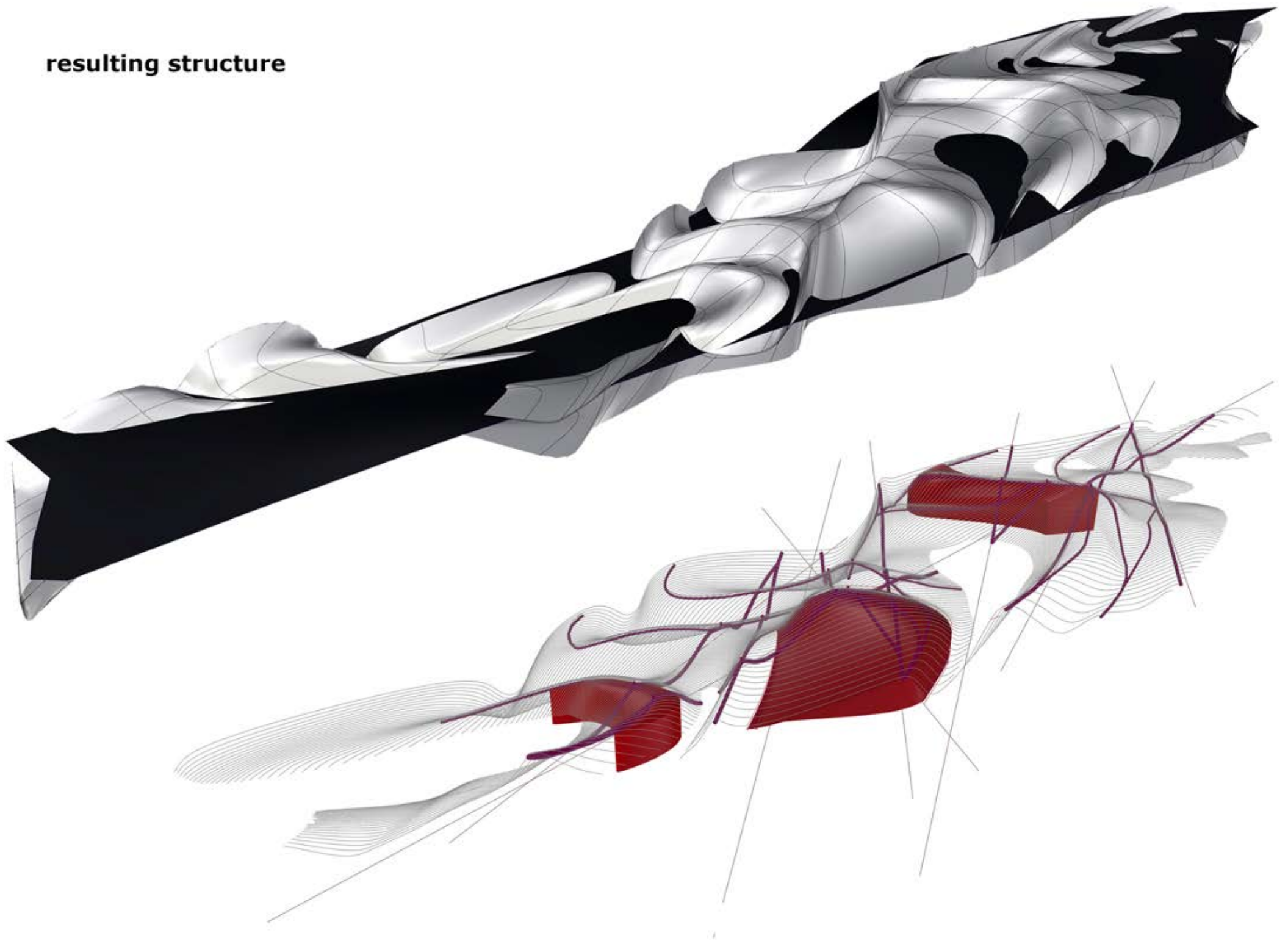

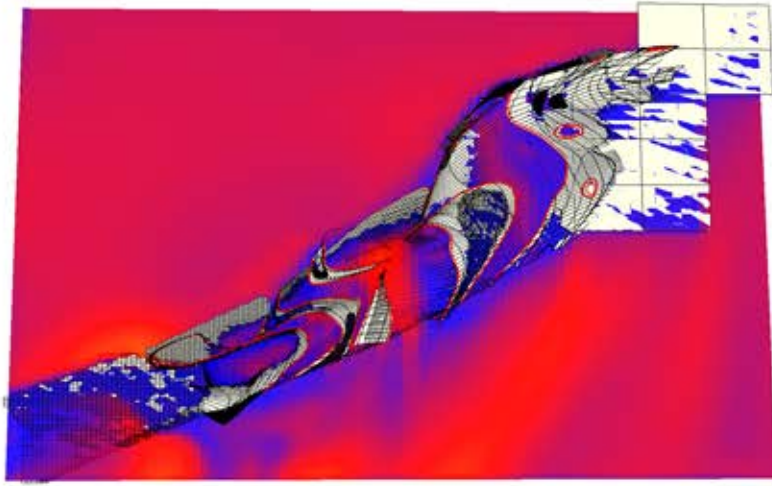

## DESIGN METHODOLOGY

testing airflow direction and temperature on cross section and floor plan structure

air flow temperature

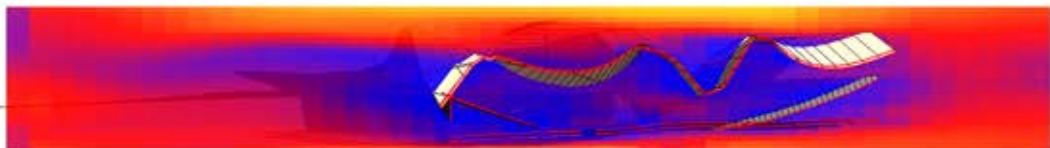
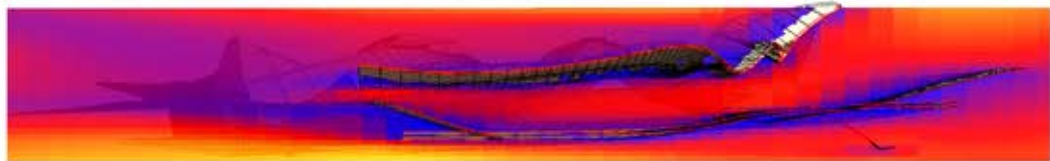
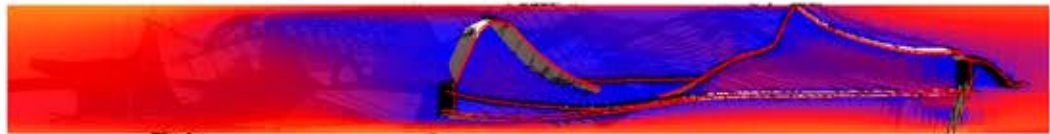
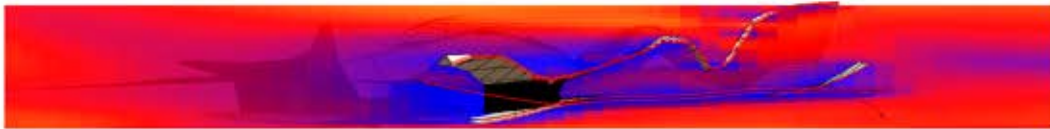

air flow direction

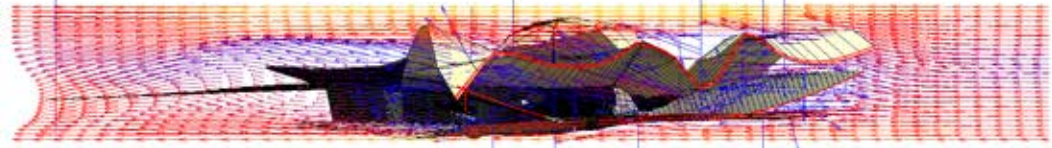
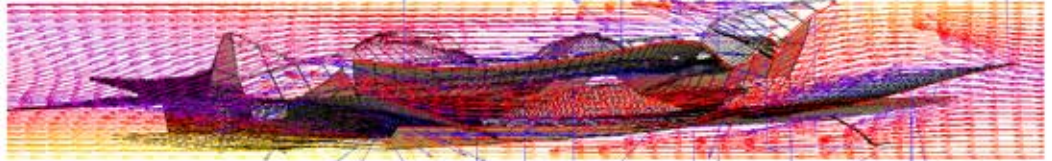
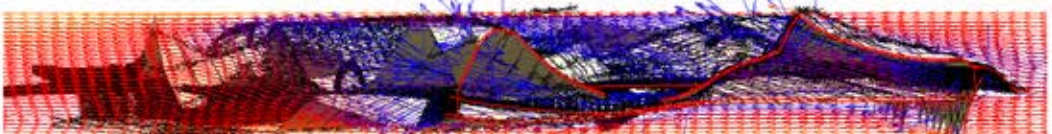
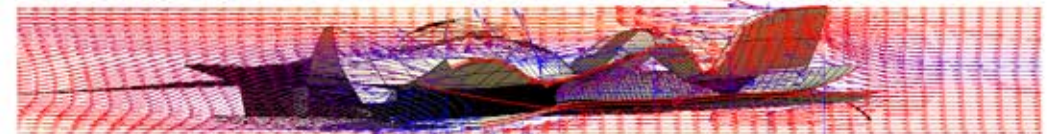

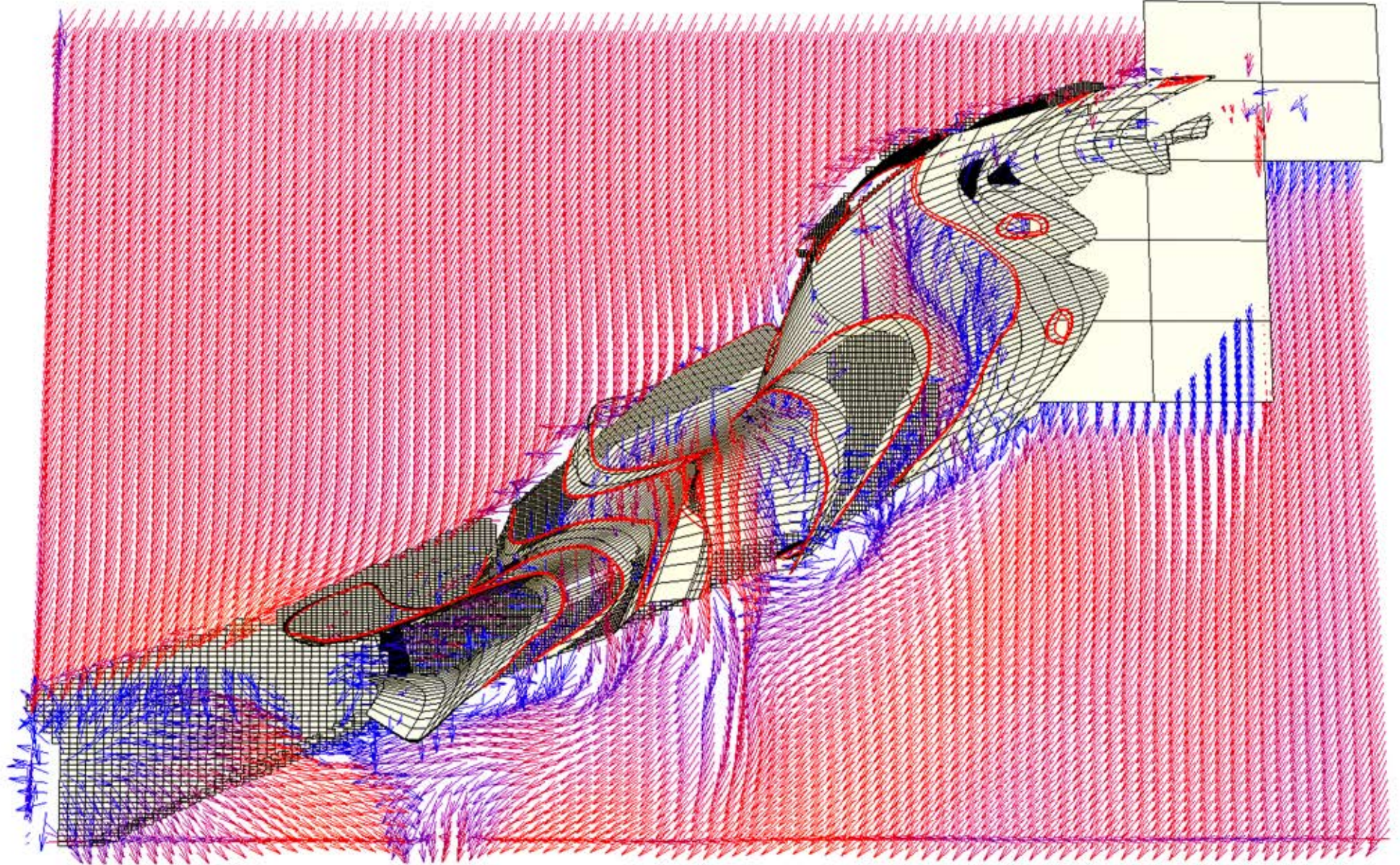

floor plan - air flow direction

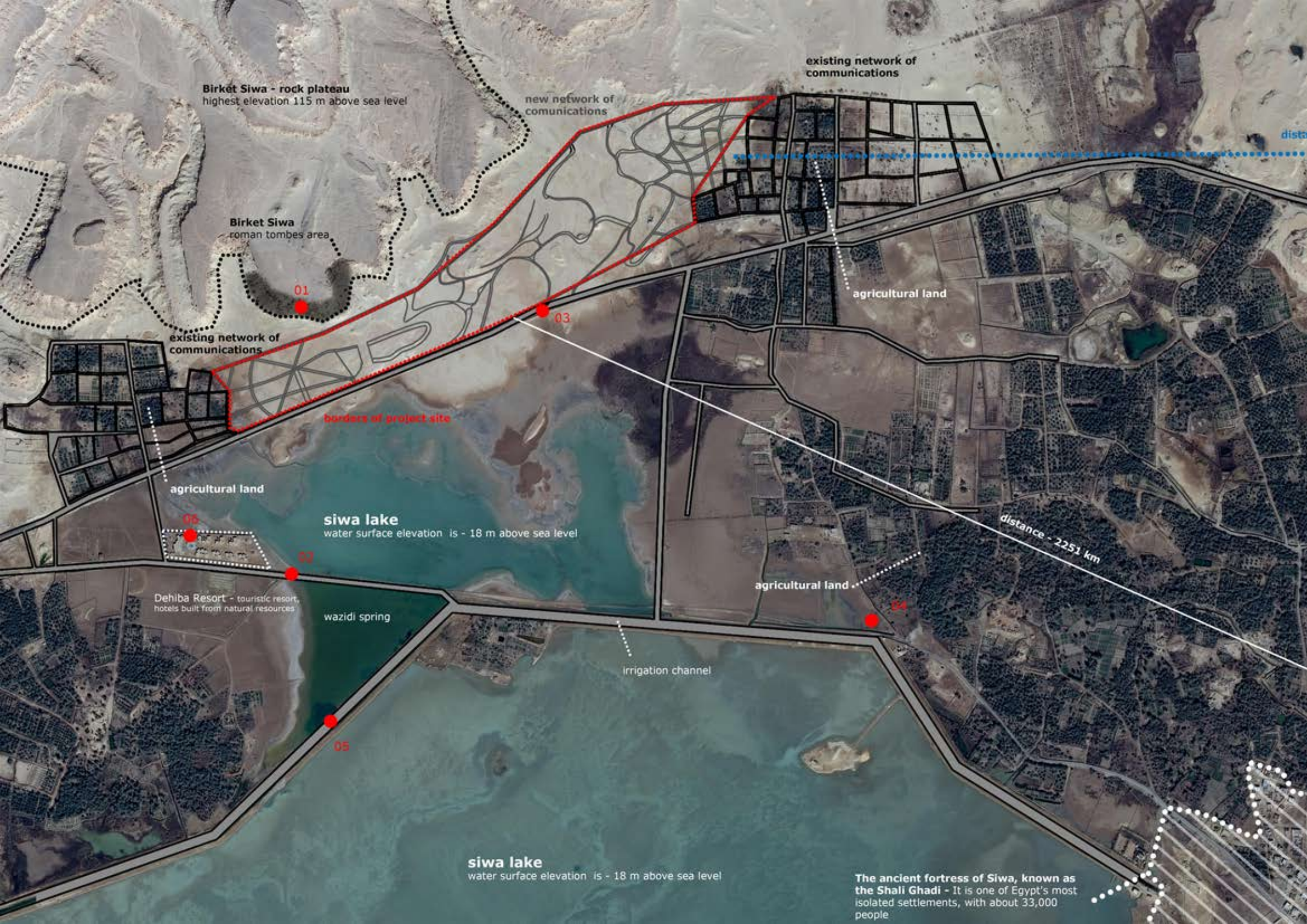

**Birket Siwa - rock plateau**  
highest elevation 115 m above sea level

**Birket Siwa**  
roman tombs area

01

existing network of communications

borders of project site

agricultural land

02

**siwa lake**  
water surface elevation is - 18 m above sea level

03

Dehiba Resort - touristic resort,  
hotels built from natural resources

wazidi spring

05

irrigation channel

**siwa lake**  
water surface elevation is - 18 m above sea level

existing network of communications

new network of communications

agricultural land

agricultural land

04

distance - 2251 km

**The ancient fortress of Siwa, known as the Shali Ghadi** - It is one of Egypt's most isolated settlements, with about 33,000 people



## PHOTODOCUMENTATION



01 birket siwa - roman tombes



02 Siwa lake



03 view of the site from road



04 siwa salt plane



05 irrigation channel



06 Dehiba resort

# DESIGN METHODOLOGY

## space distribution scheme



**second underground floor**  
**public space and market**  
space for trade of goods and information, accessible from main structure entrances, should be accessible for public as well, social space for community

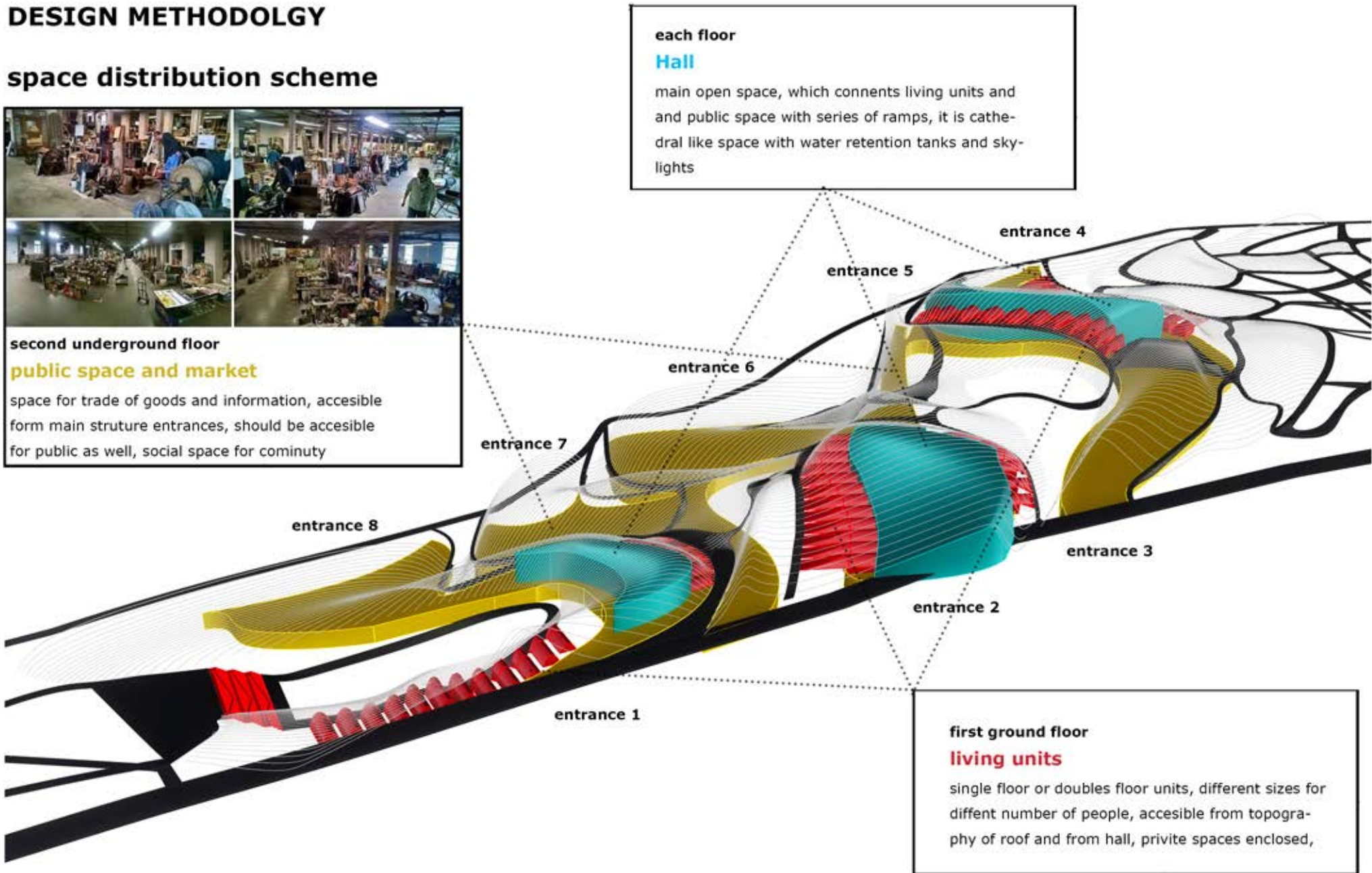

**each floor**  
**Hall**  
main open space, which connects living units and public space with series of ramps, it is cathedral like space with water retention tanks and skylights

**first ground floor**  
**living units**  
single floor or double floor units, different sizes for different number of people, accessible from topography of roof and from hall, private spaces enclosed,

# DESIGN METHODOLOGY

## concept of ventilation scheme

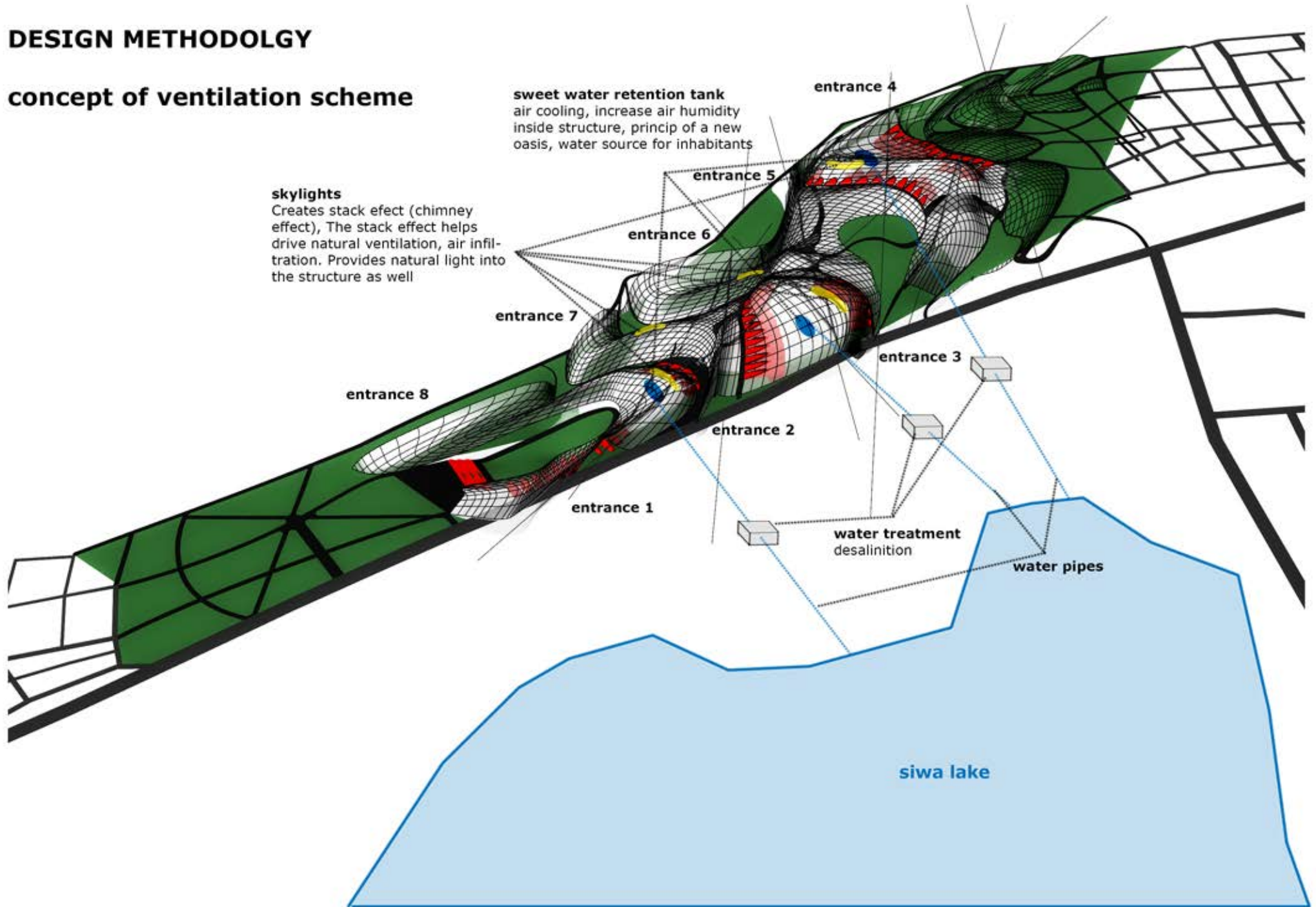

**SITUATION**



# FLOOR PLANS

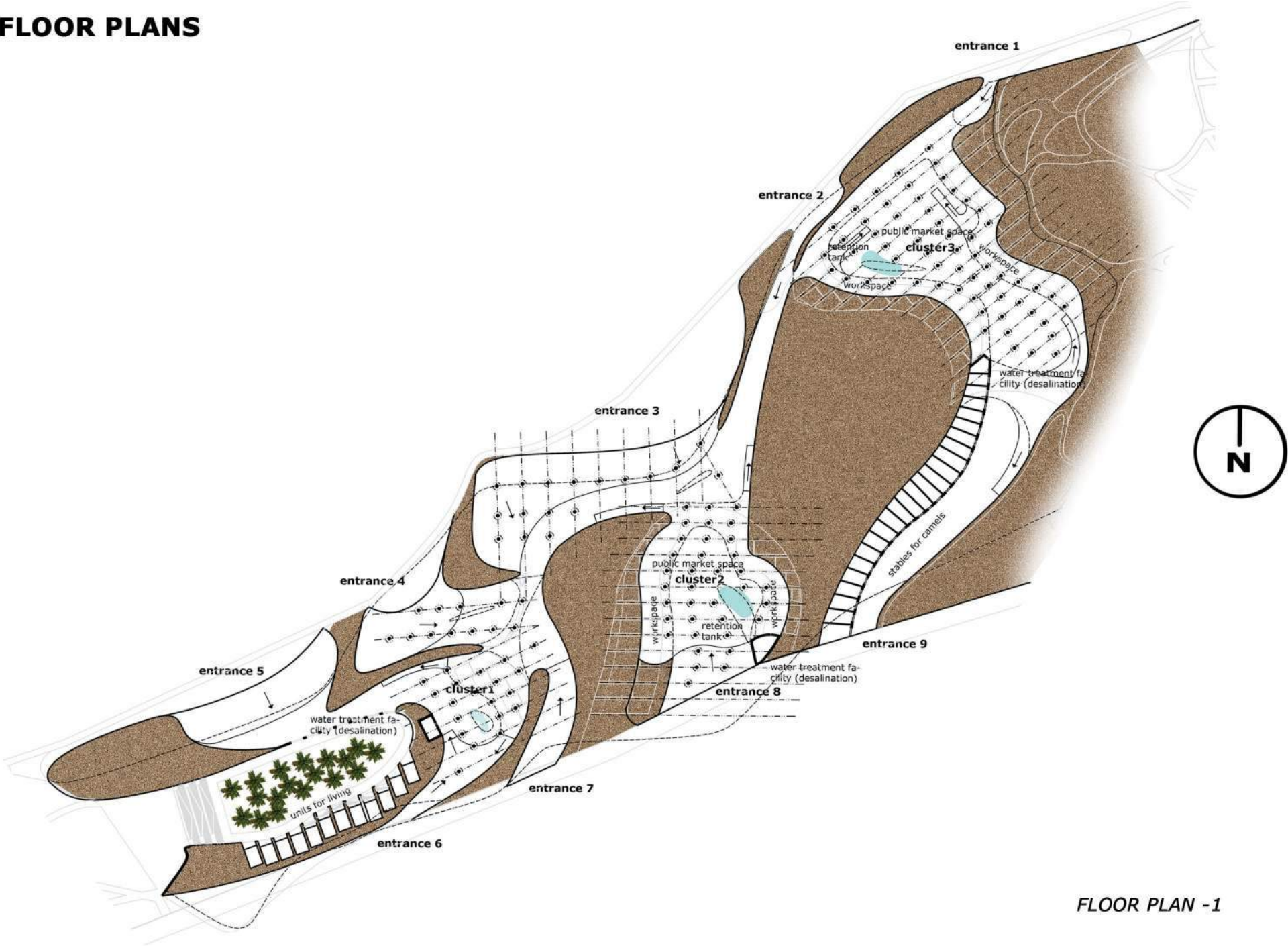

FLOOR PLAN -1

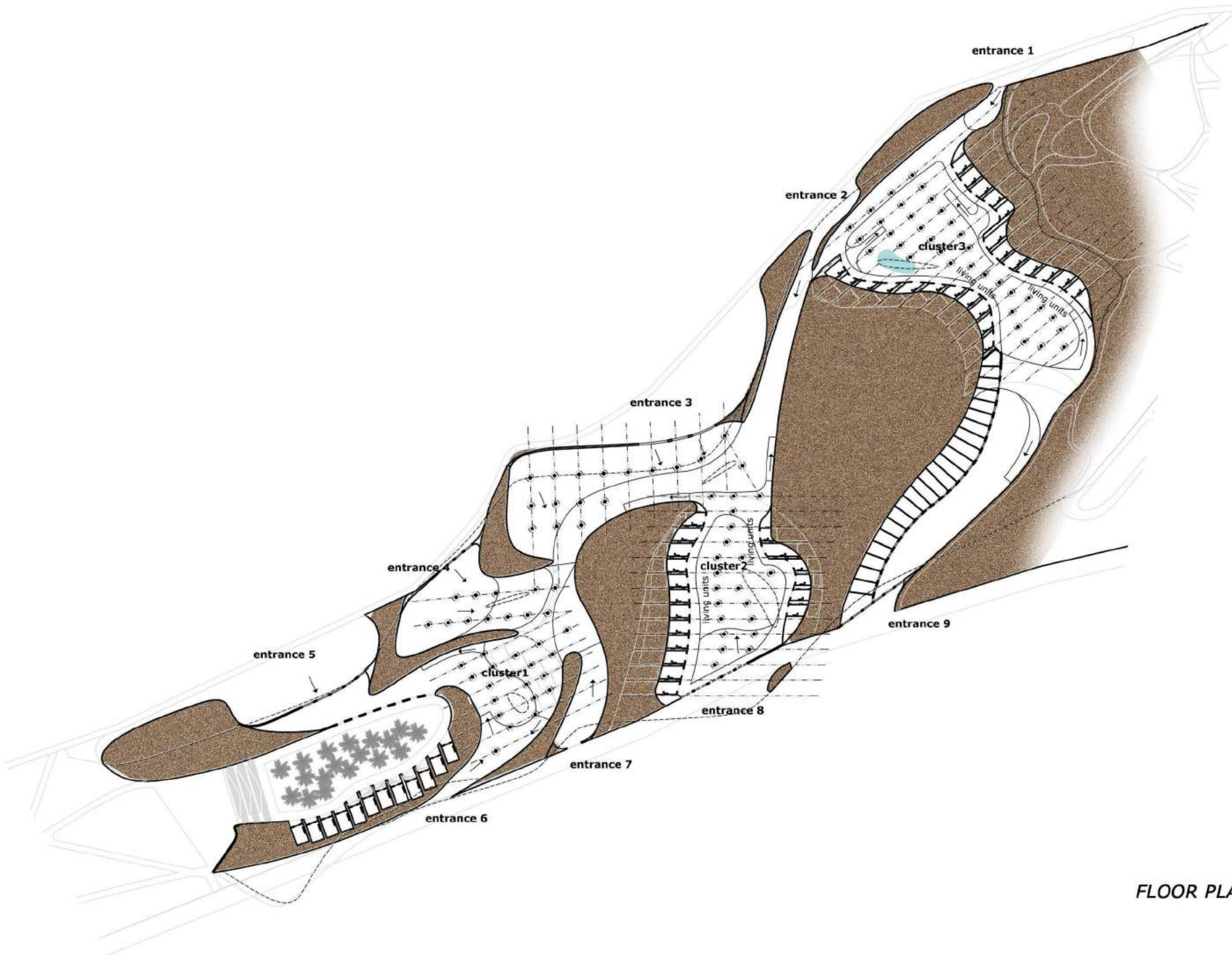

FLOOR PLAN 1

**FLOOR PLANS**

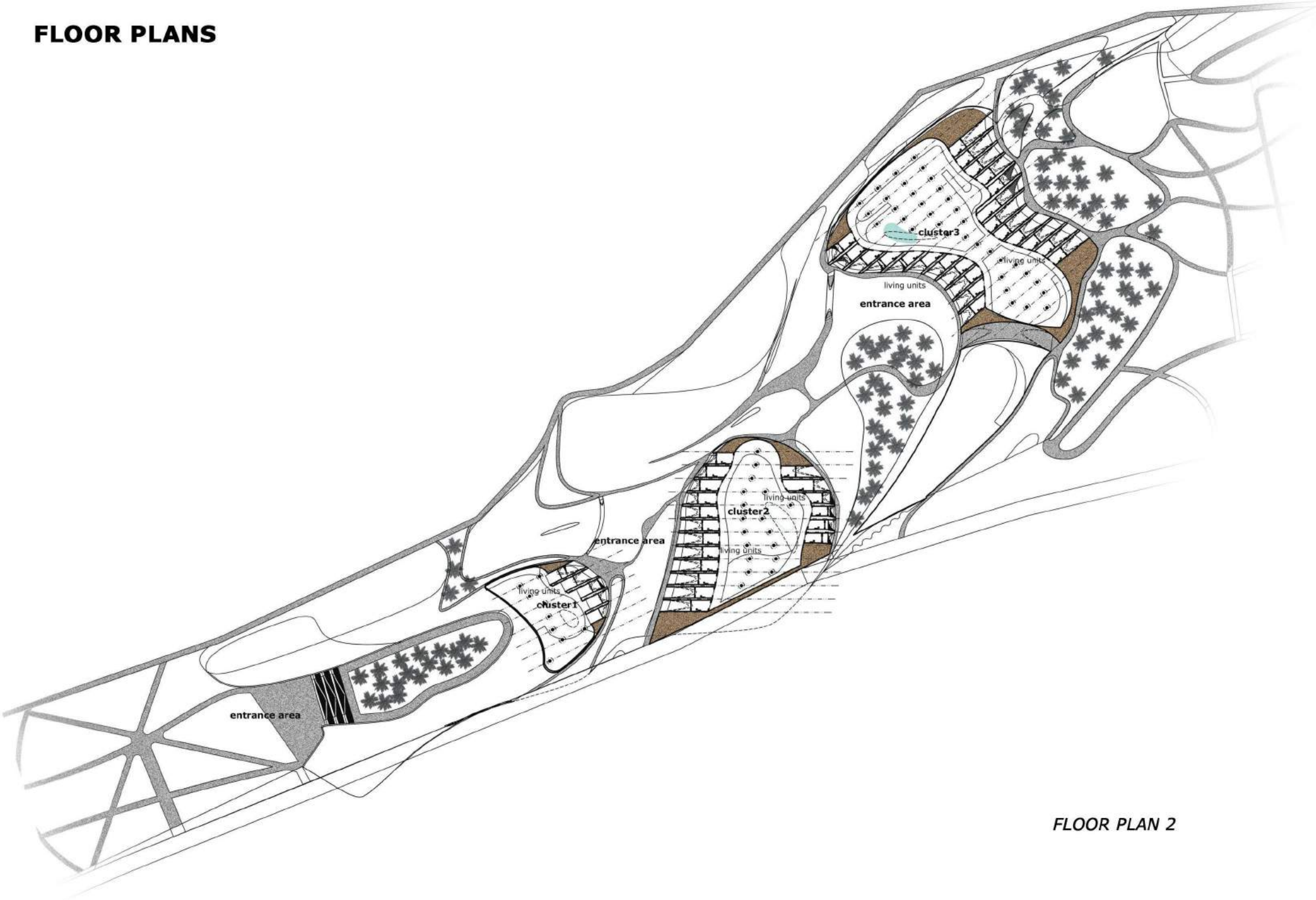

*FLOOR PLAN 2*

**ELEVATIONS**

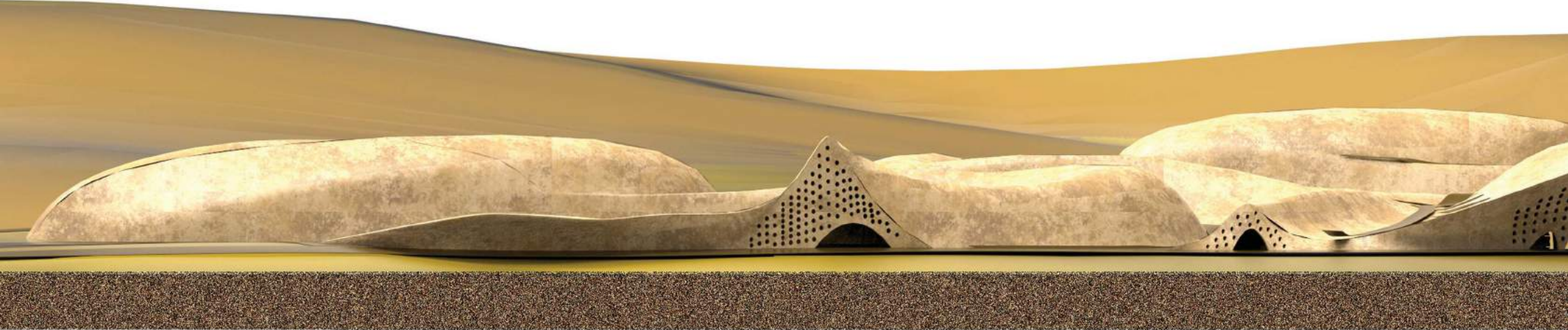



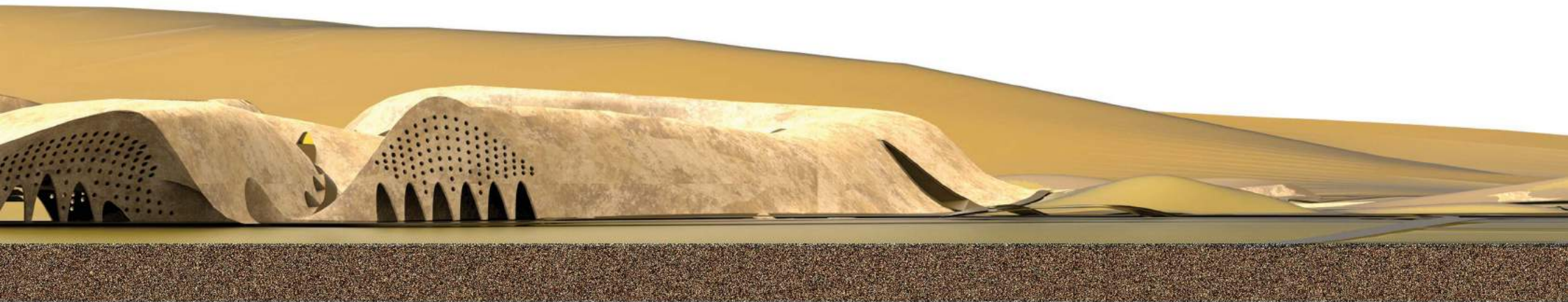

*SOUTHERN ELEVATION*



*NORTHERN ELEVATION*

# ELEVATIONS





*WESTERN ELEVATION*

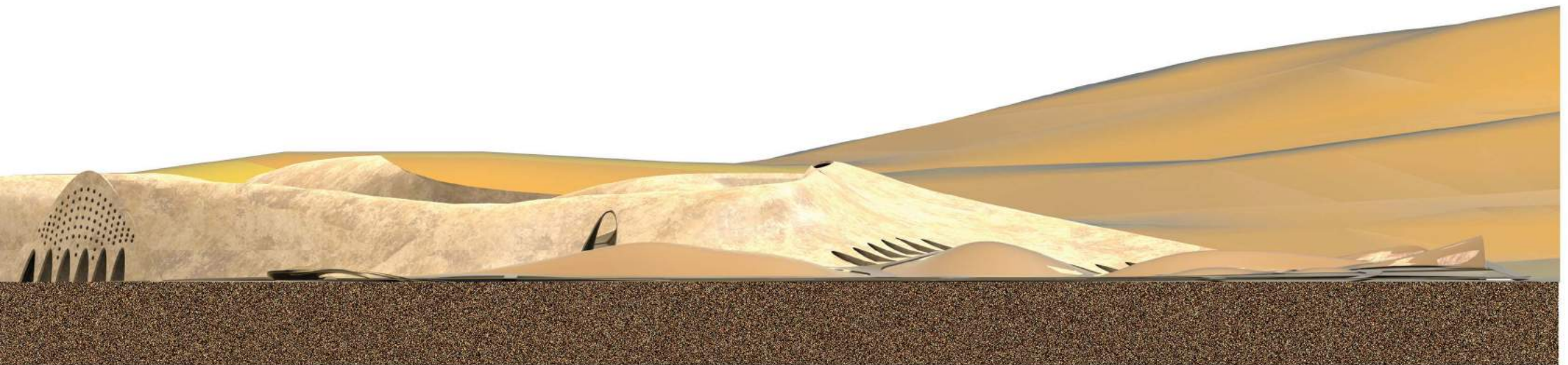

*SOUTHWESTERN ELEVATION*

**LONGITUDINAL SECTION**

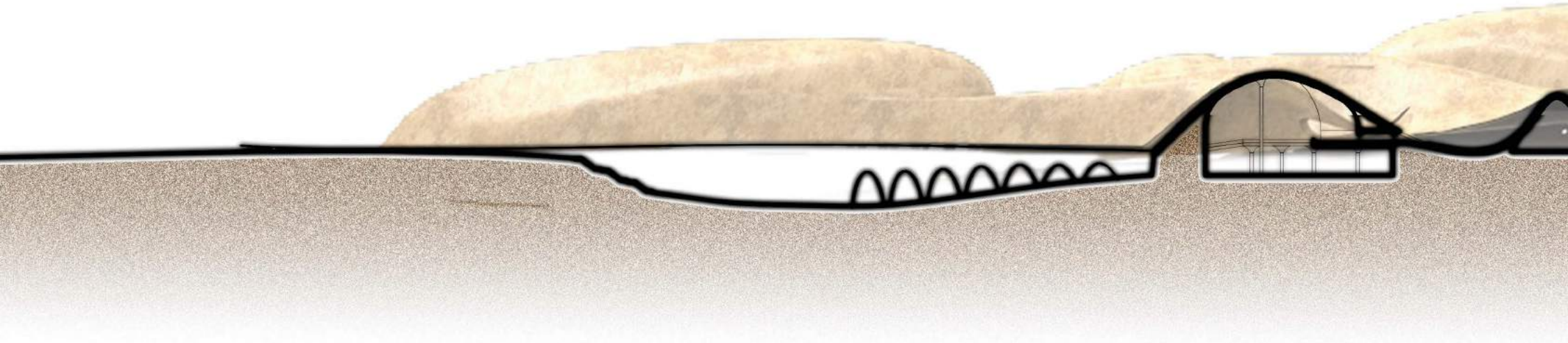

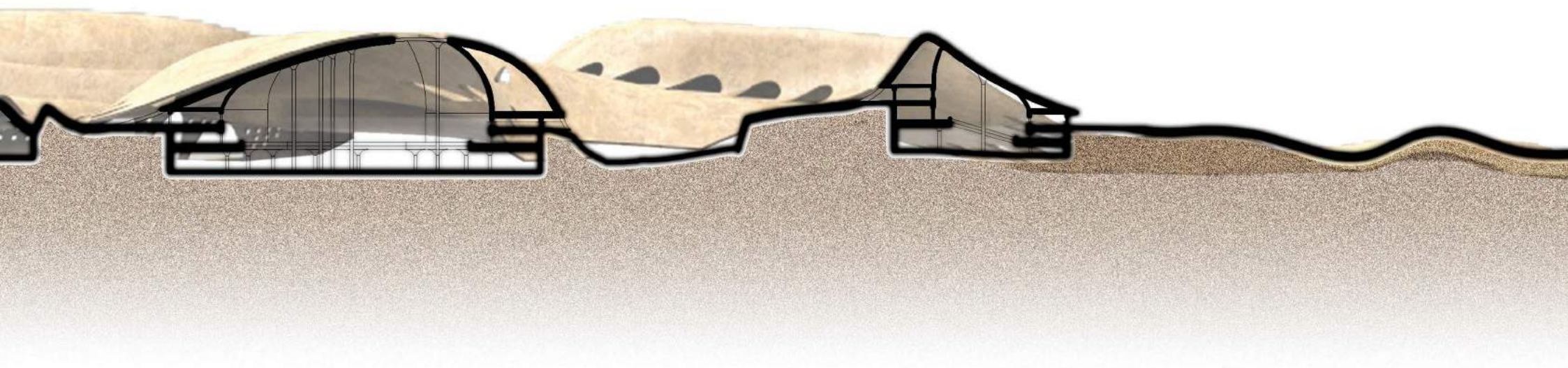

# PHASES

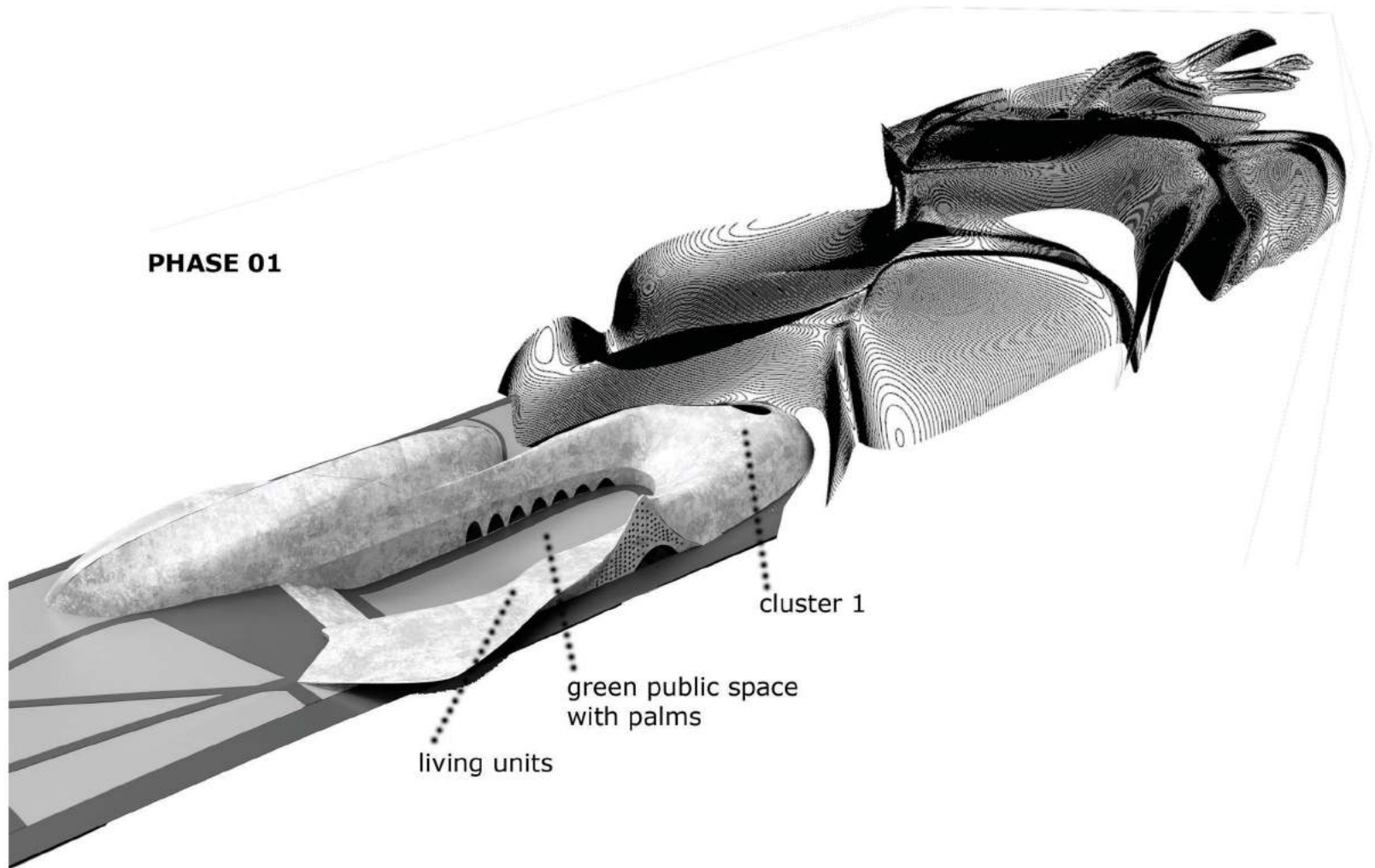

**PHASE 02**

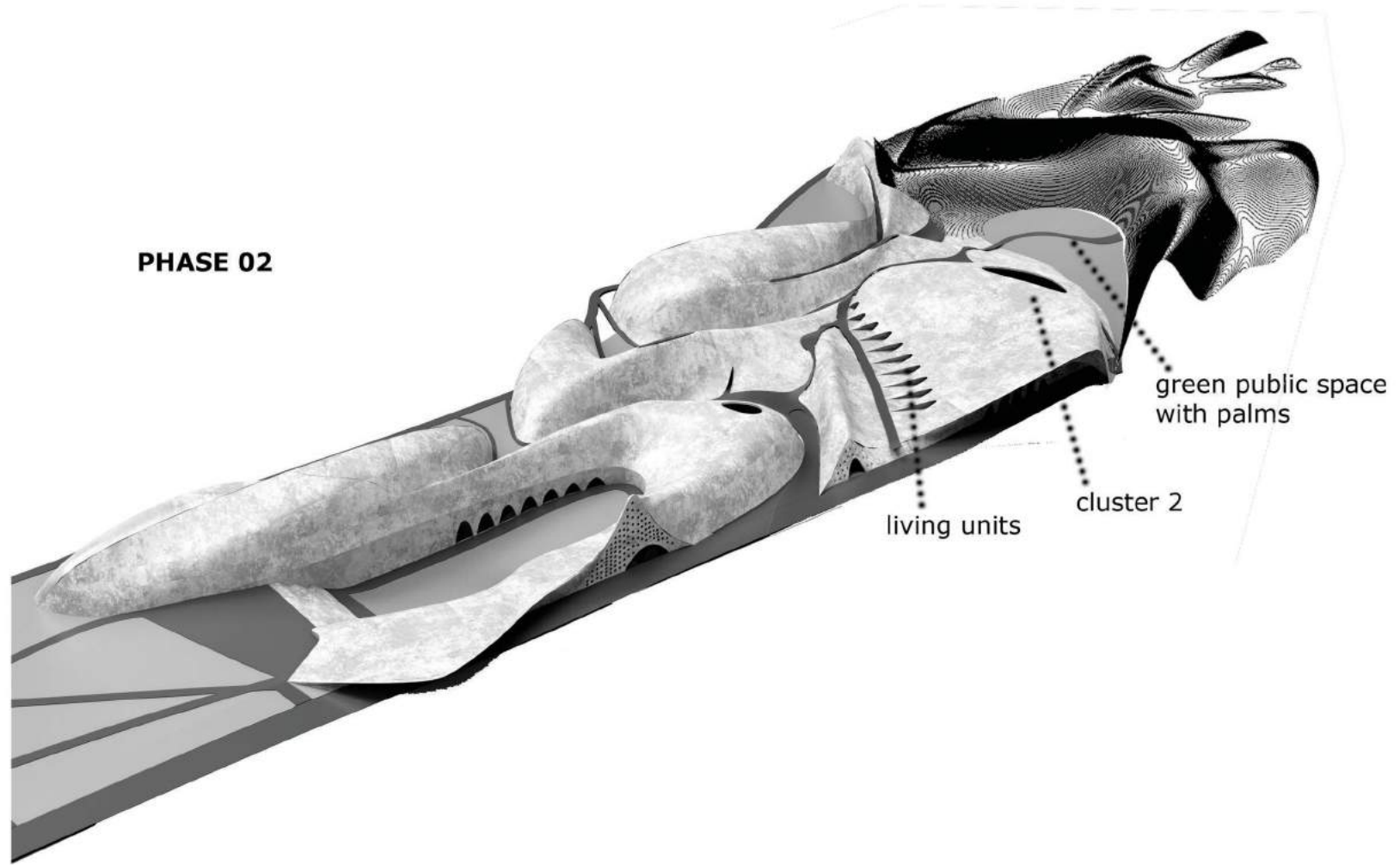

living units

cluster 2

green public space  
with palms

# PHASES

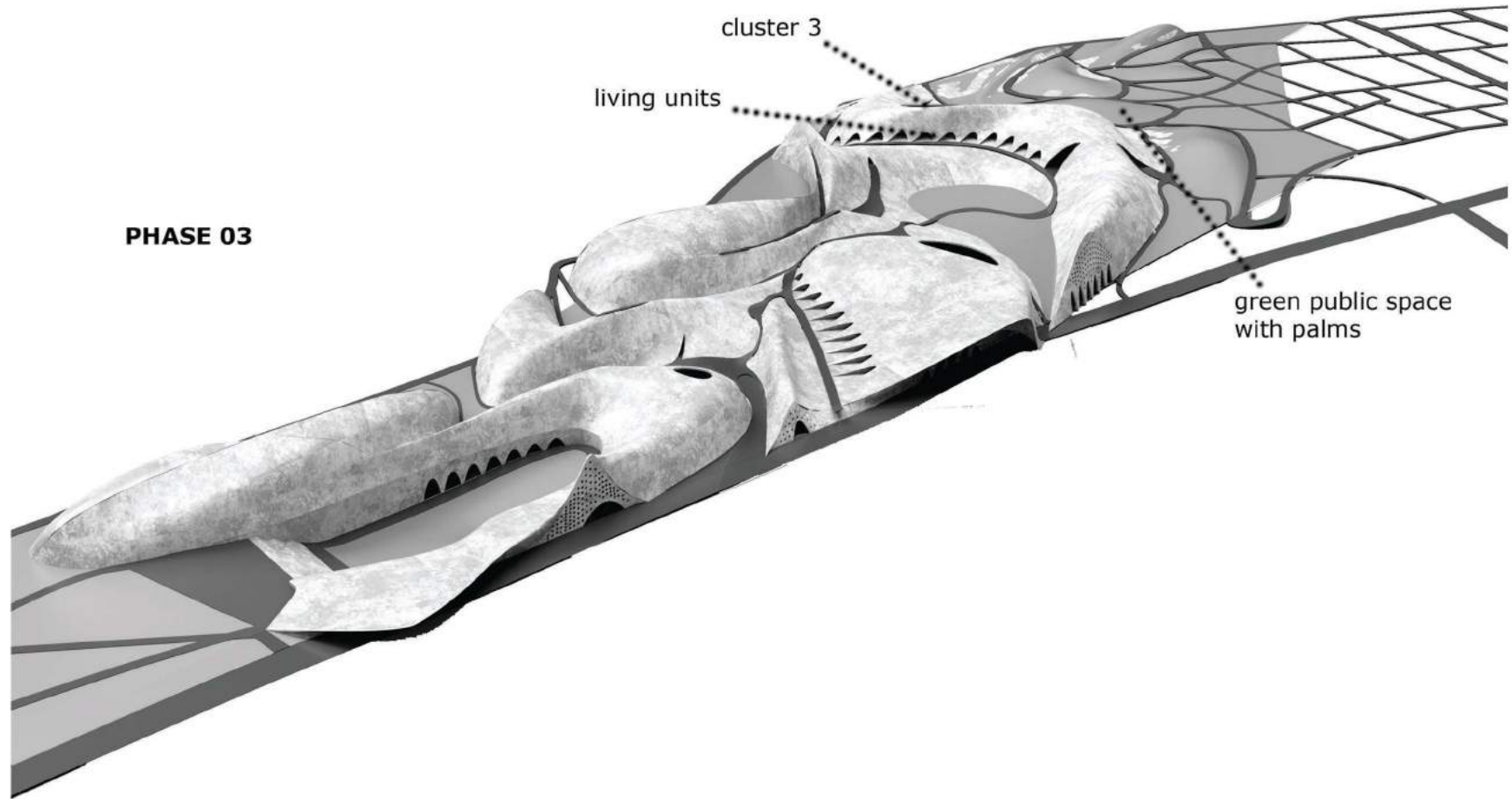





**VISUALISATION**

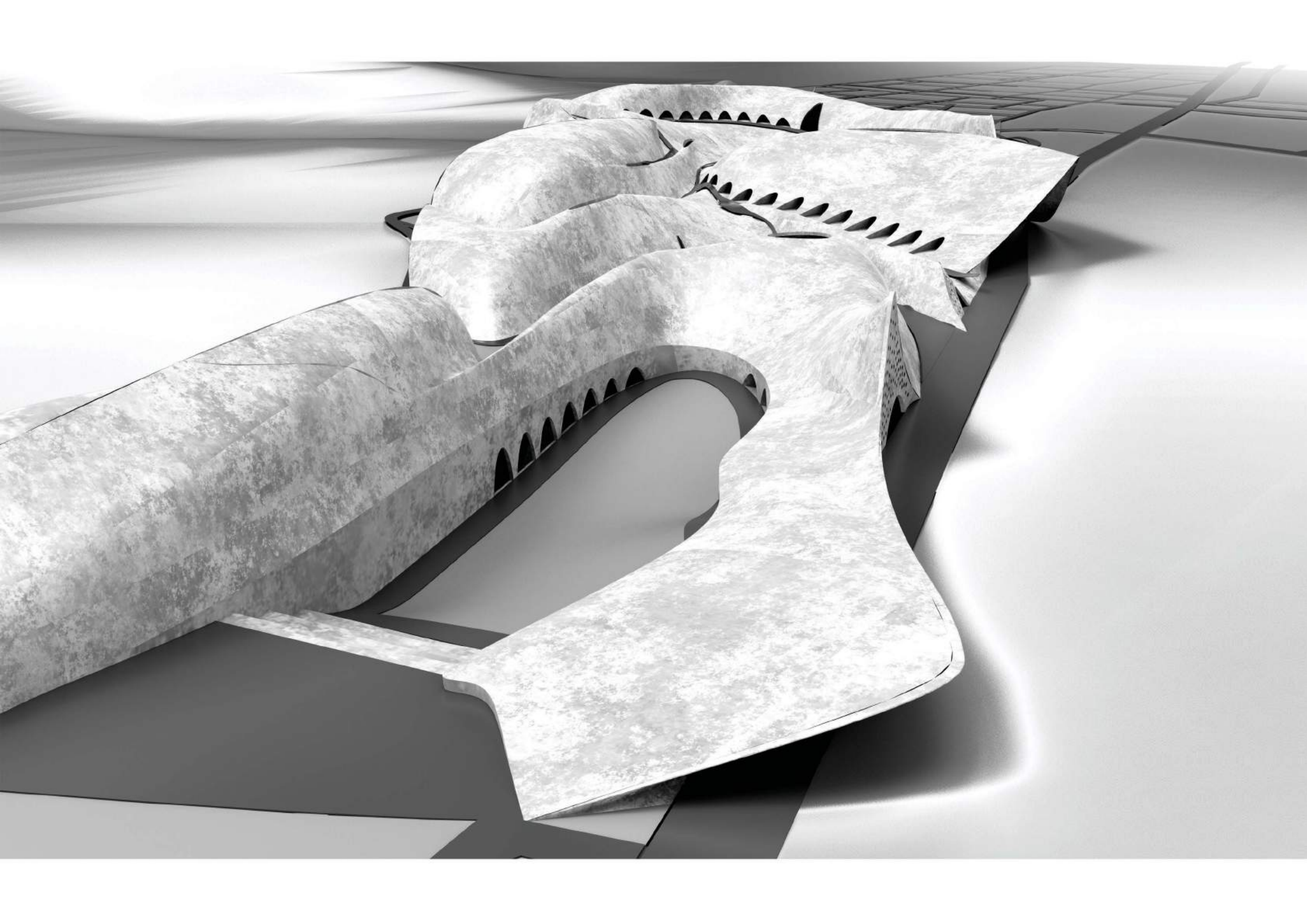

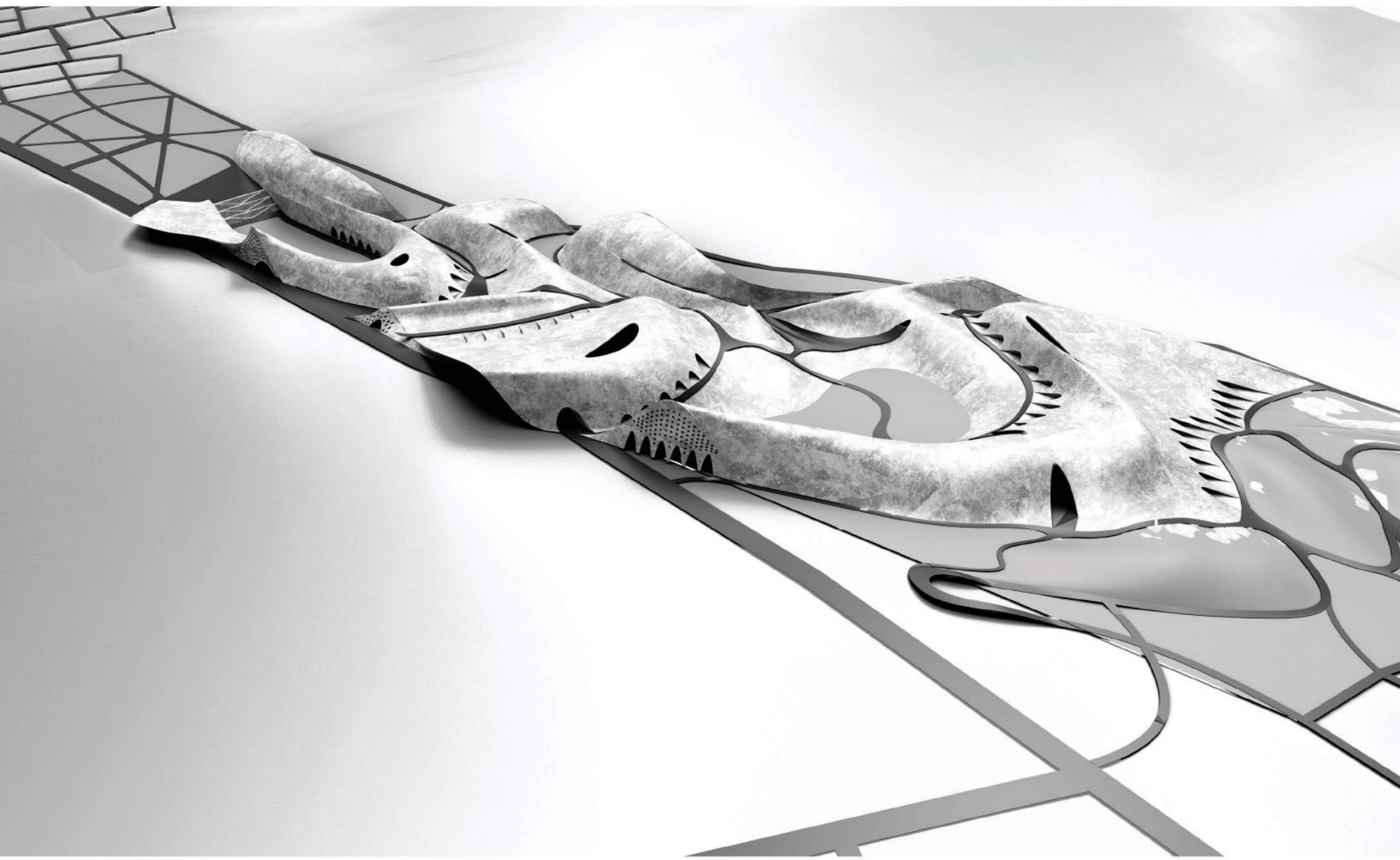

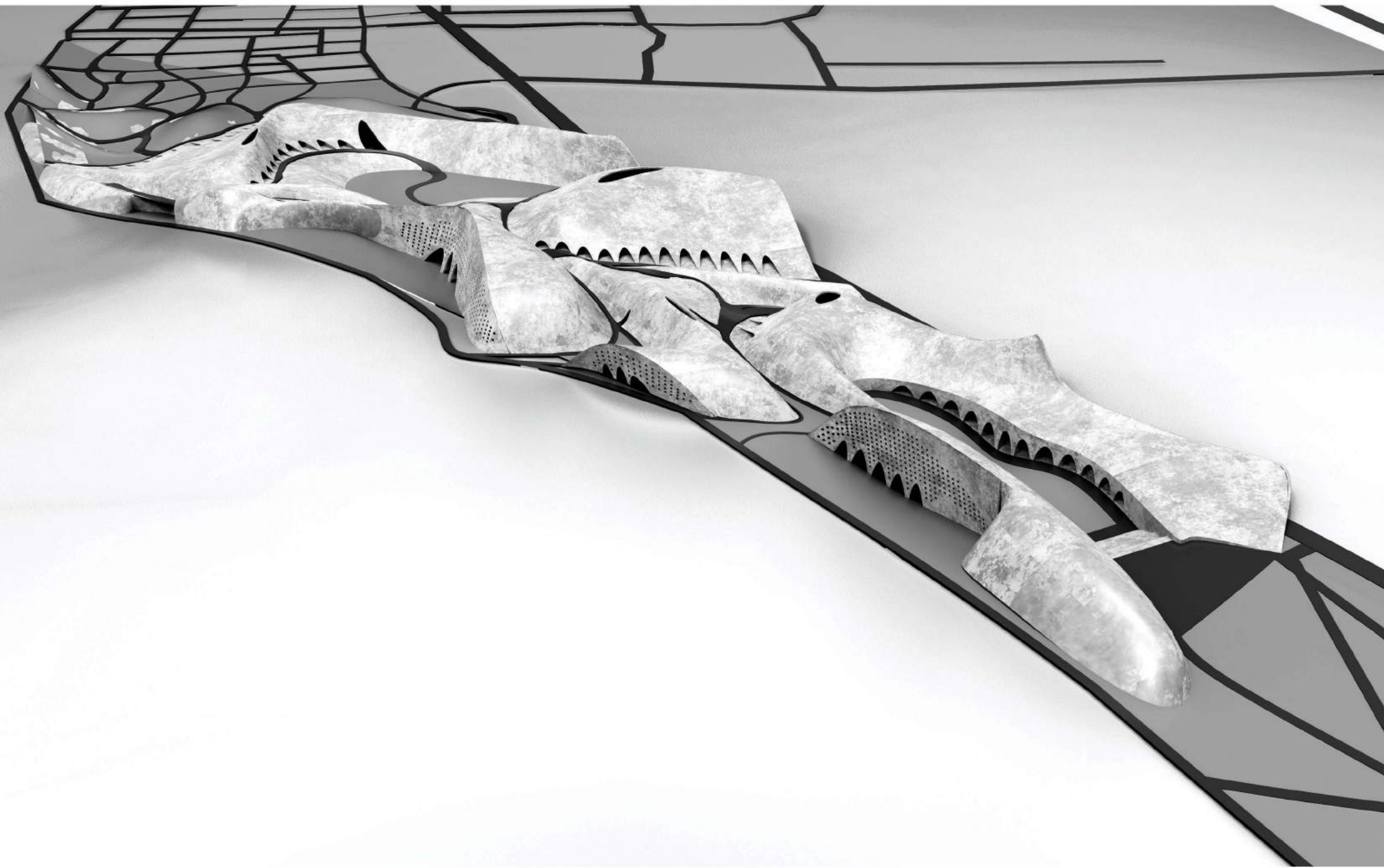

07



# ARCHITECTURAL CONCEPT

## Vault design

Urban structure has been divided into several vault structures resulting from wind and climate analysis. Three main vault segments of urban concept structure were defined as living clusters, where accommodation and trade market happens, camel stables and relax zones are also included in this spaces. Other vault segments are defined as a entrance and very important air intakes. Cluster 2 has been further processed by form finding process, was detaily defined. Similar proces can be applied to the other vault segments of the stucture.

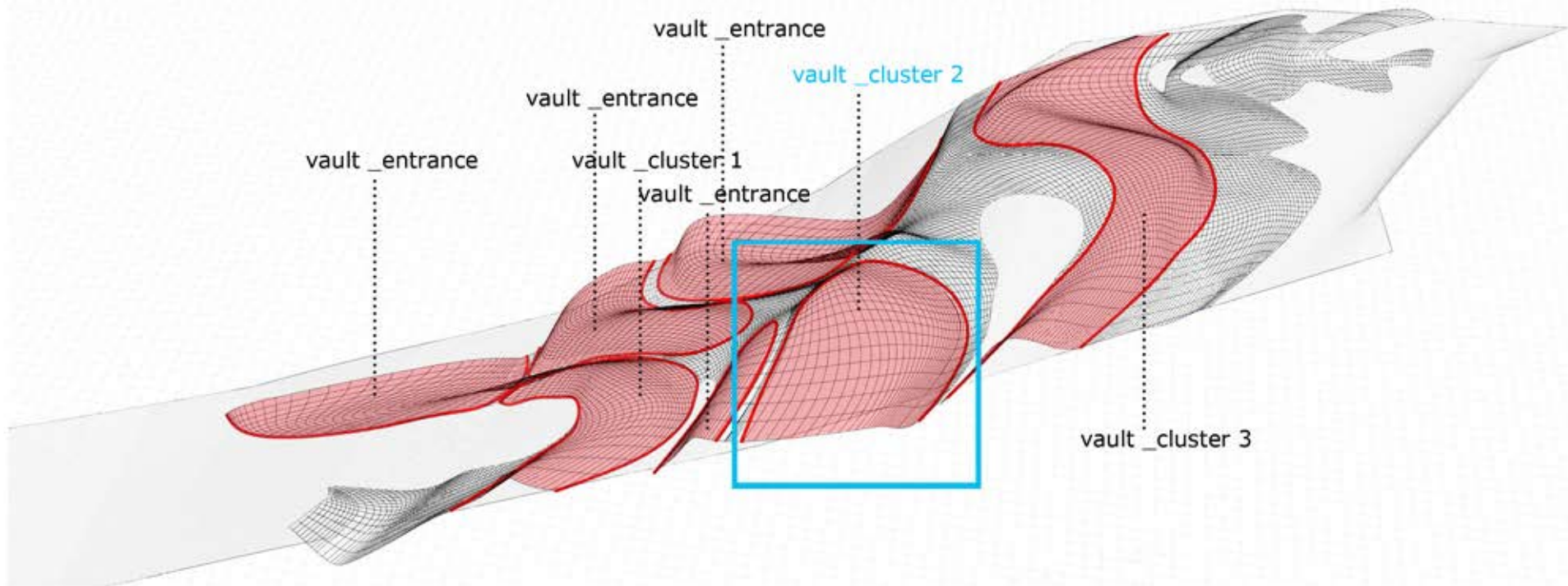
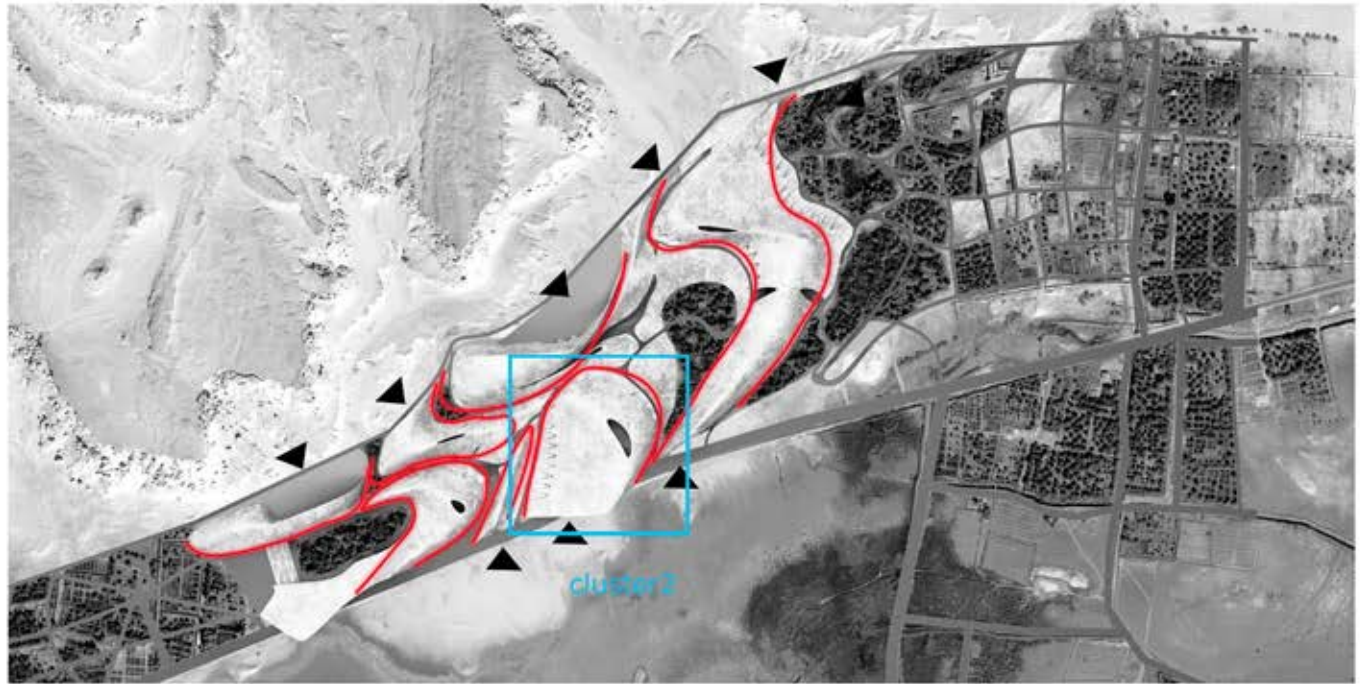



## Form finding process

source:  
Form finding and structural analysis of a freeform stone vault

Tom VAN MELE, Anjali MEHROTRA, Tomás MENDEZ ECHENAGUCIA,  
Ursula FRICK, John OCHSENDORF, Matthew DEJONG, Philippe BLOCK

ETH Zurich, Institute of Technology in Architecture, Block Research Group

The design of an unreinforced, discrete, cut-stone, dry-set vault with complex geometry is a complicated process that requires an integrated computational setup that from the early design. The process of finding an appropriate form that allows the vault to stand in pure compression, taking into account the architectural and functional requirements of the object in relation of a urban design. The funicular shape of the vault is the result of a form-finding process based on Thrust Network Analysis. As a first step, preliminary design alternatives were sketched using **RhinoVAULT**. From the chosen sketch design, a control mesh was created and used to iteratively refine the geometry to increase double curvature and distribute the vertical reaction forces as evenly as possible over the supports.

### Target geometry

Target geometry is defined by spatial distribution from a wind directed surface that was developed for a urban concept in order to maintain a height and curvature of a given surface. it is important to place internal supports (A,B,C) of a stone vault structure in order to create a pure tension geometry that is similar to geometry defined earlier, therefore number of sketches were evaluated until the surface mesh was developed.

### TARGET GEOMETRY

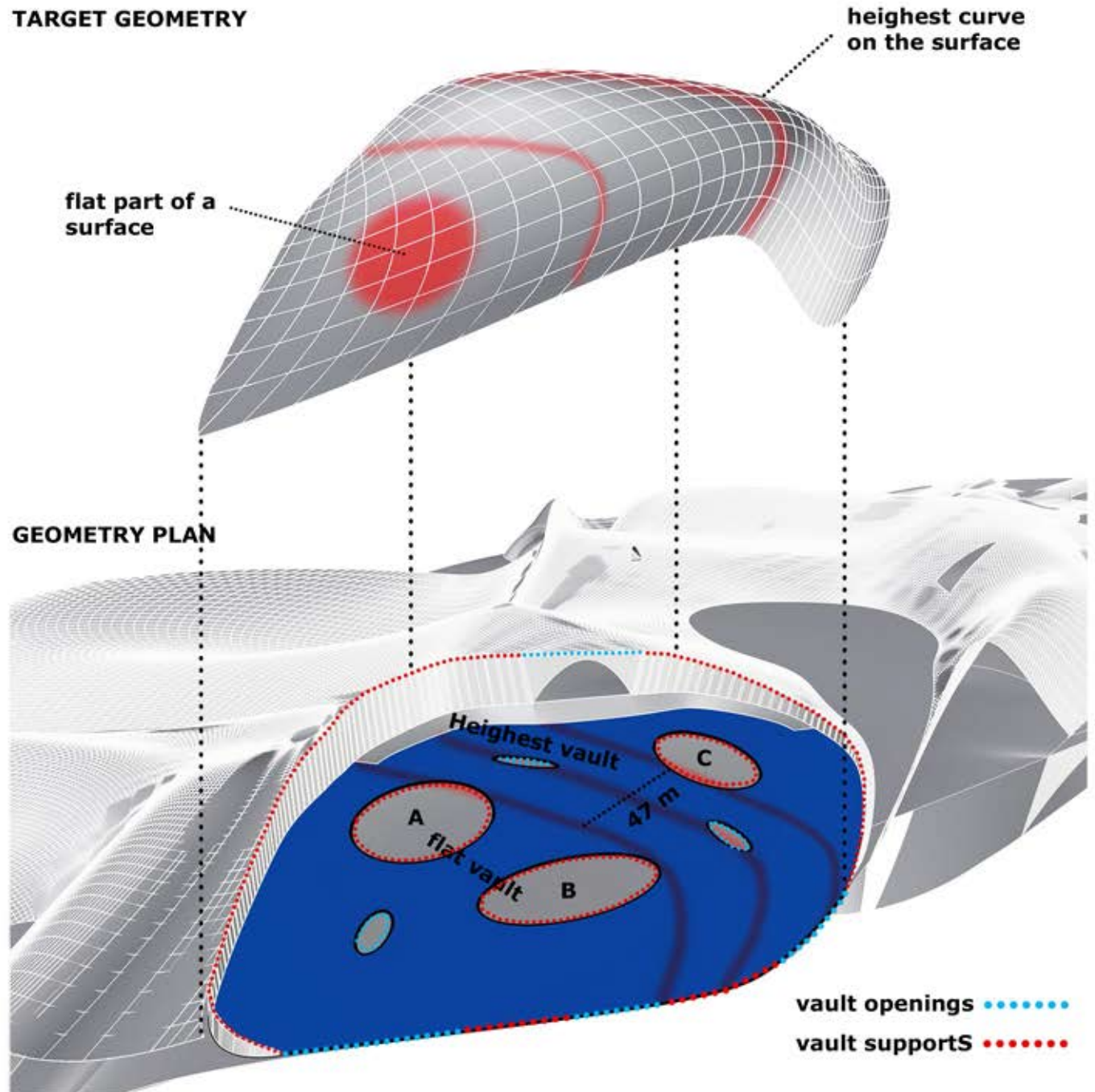

flat part of a surface

highest curve on the surface

### GEOMETRY PLAN

Highest vault

A flat vault

47 m

vault openings .....

vault supports .....

# ARCHITECTURAL CONCEPT

## vault design

### form diagram

Thrust Network Analysis (TNA) uses form and force diagrams to control the spatial equilibrium of a three-dimensional network of compressive forces for a given set of parallel loads. The form diagram represents the directions along which horizontal forces are allowed to flow. The magnitude of forces along those directions is represented by the force diagram.

The layout of force directions was derived from the geometric and structural features of the three-dimensional target geometry. Triangulated geometrical network is created with RhinoVAULT software. The dual graph is generated (form and force diagram). These diagrams are used to calculate TNA. For finding an equilibrium it is important to reduce horizontal angles in plan network therefore form relax reduces bad angle thrust network. This function effects only form diagram. Then horizontal equilibrium can be found with alteration of force diagram.

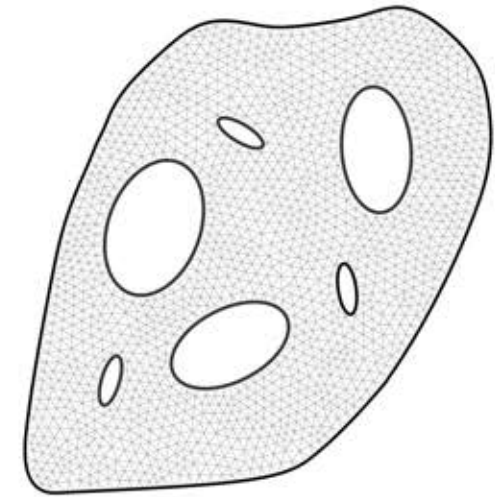

triangulated network

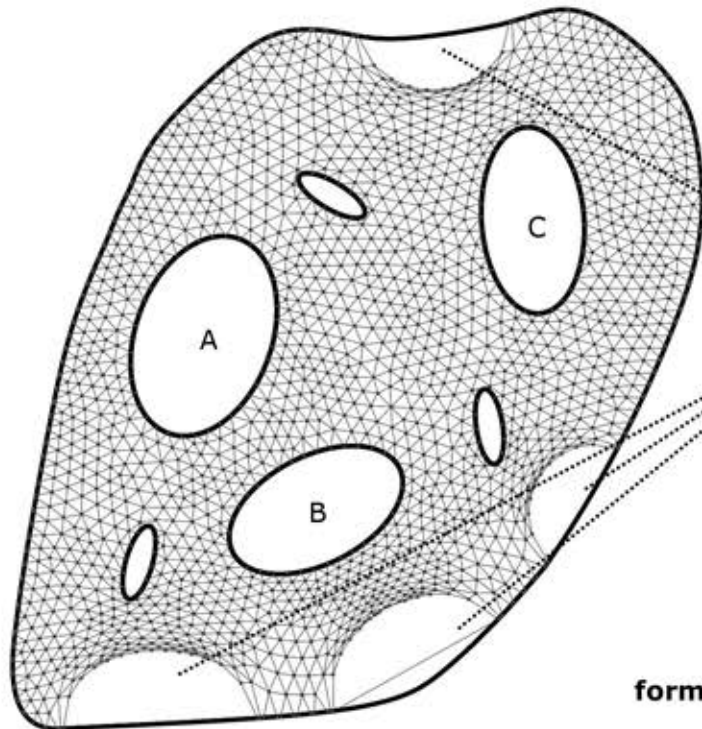

form diagram

openings into the structure are not constrained - relax functions influence this form diagram

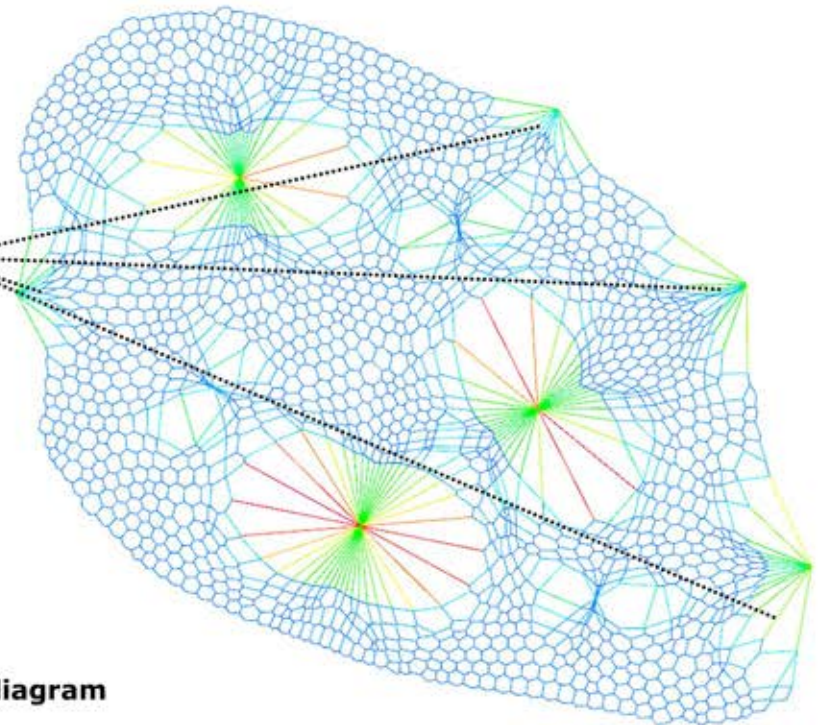

force diagram

**horizontal equilibrium**

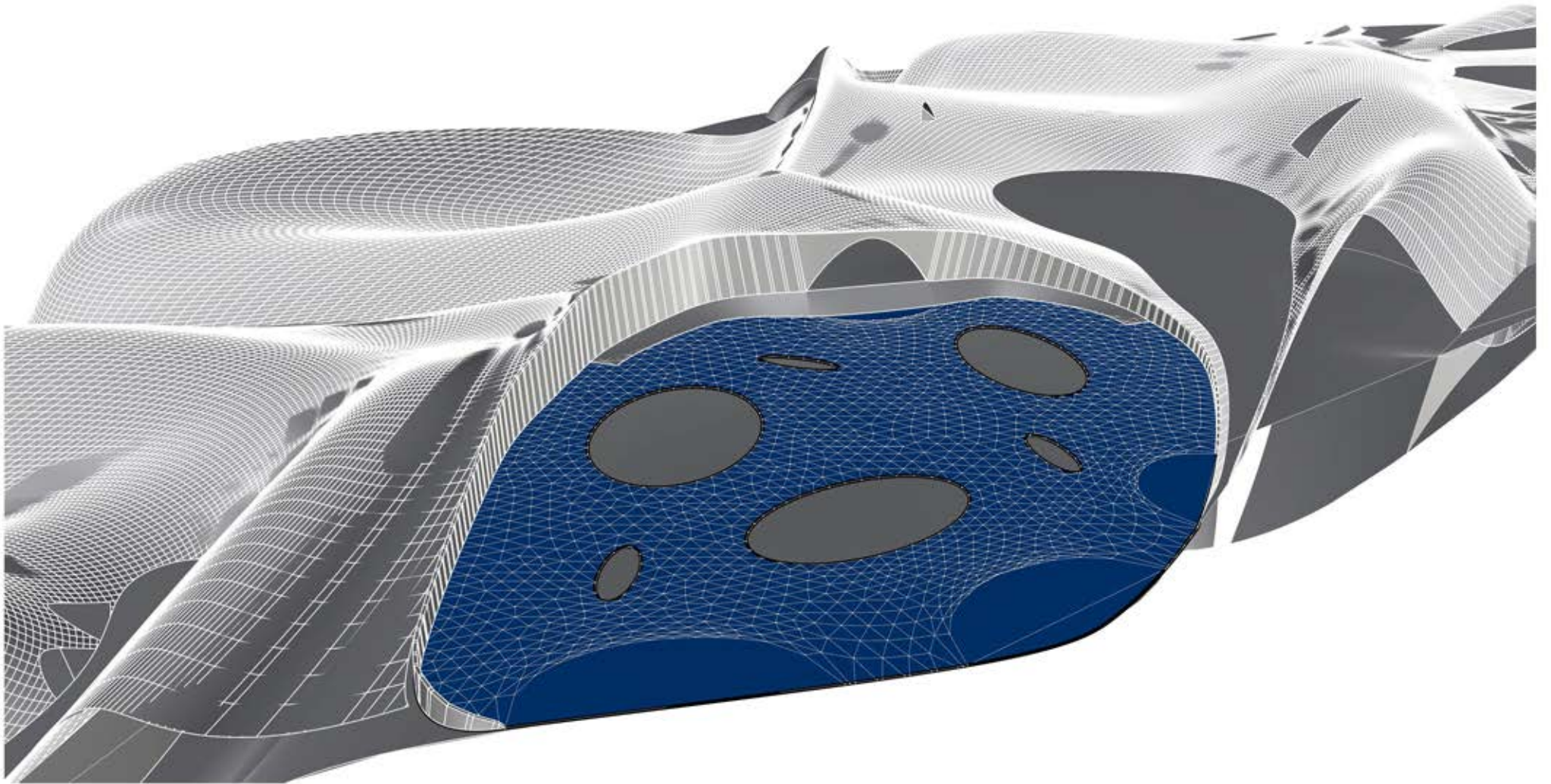

# ARCHITECTURAL CONCEPT

## vault design

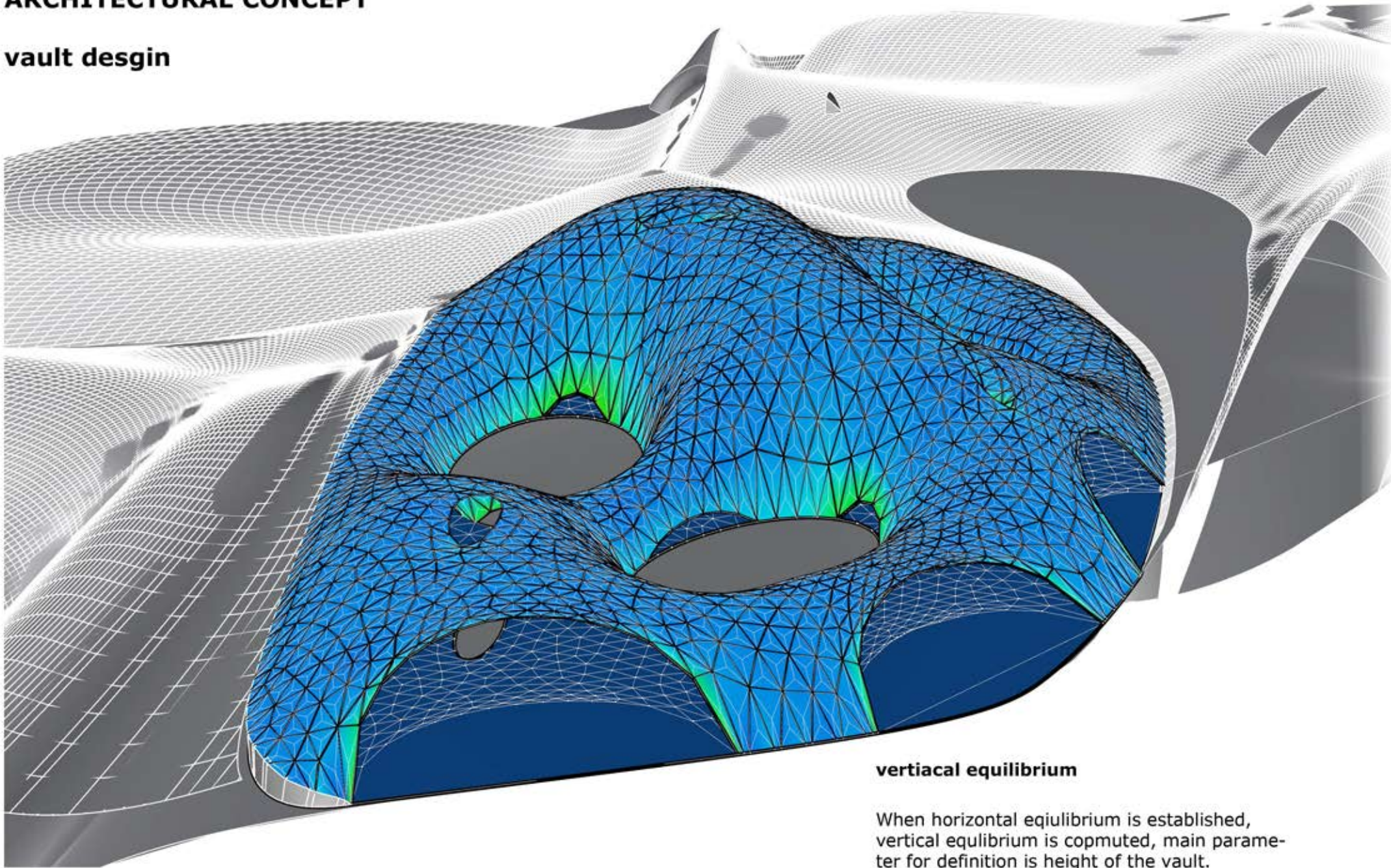

### vertical equilibrium

When horizontal equilibrium is established, vertical equilibrium is computed, main parameter for definition is height of the vault.

The dominant loading on this vault is its own weight. During the form-finding process only this load is taken into account to define the geometry of the middle surface of the vault. The intrados and extrados are offset from that middle surface according to the local thickness defining the boundaries of the stone envelope. This thickness may be increased to accommodate the development of thrust networks within the middle third of the envelope for all other loading cases.

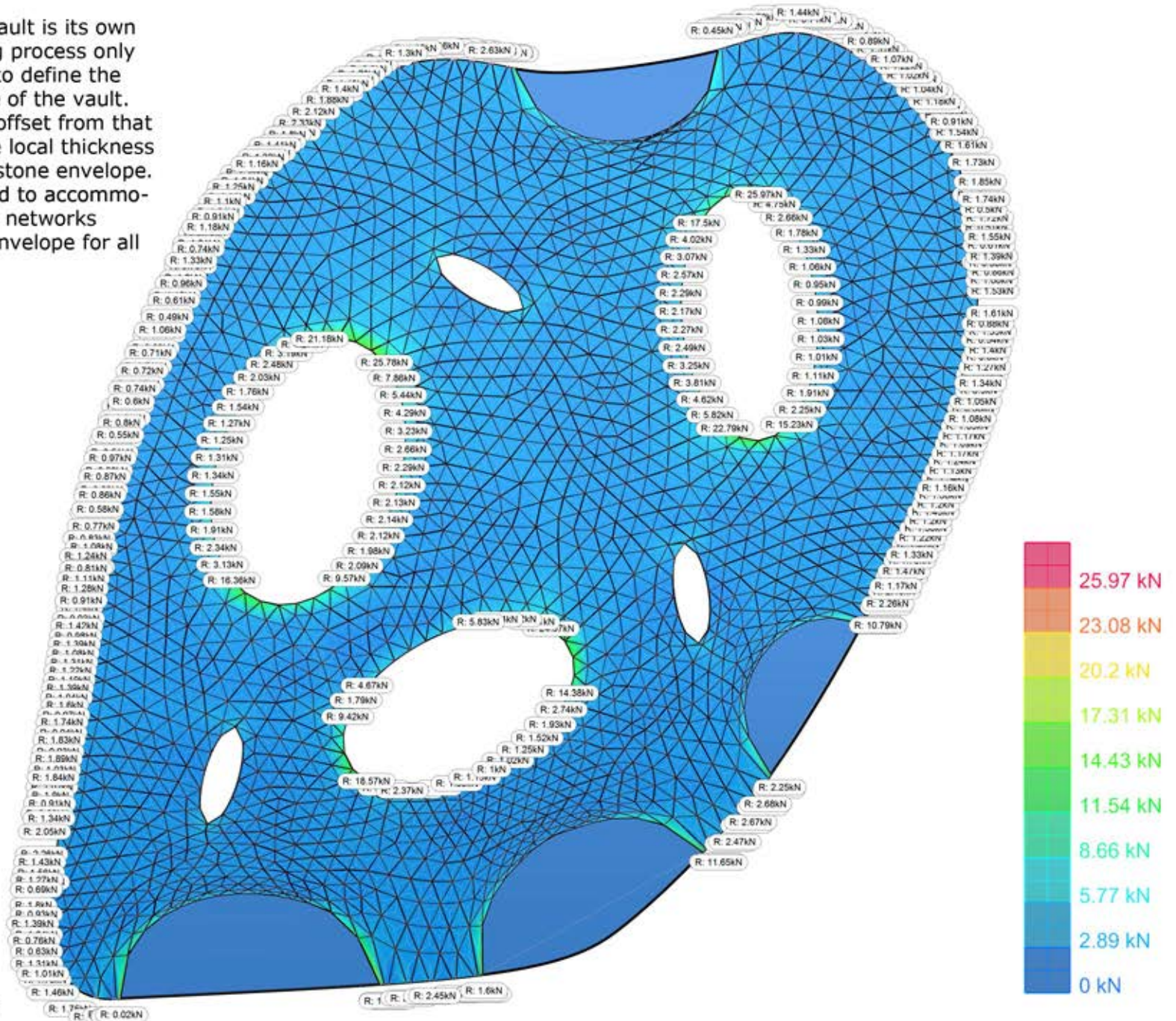

vault plan - load calculation

# ARCHITECTURAL CONCEPT

## vault design

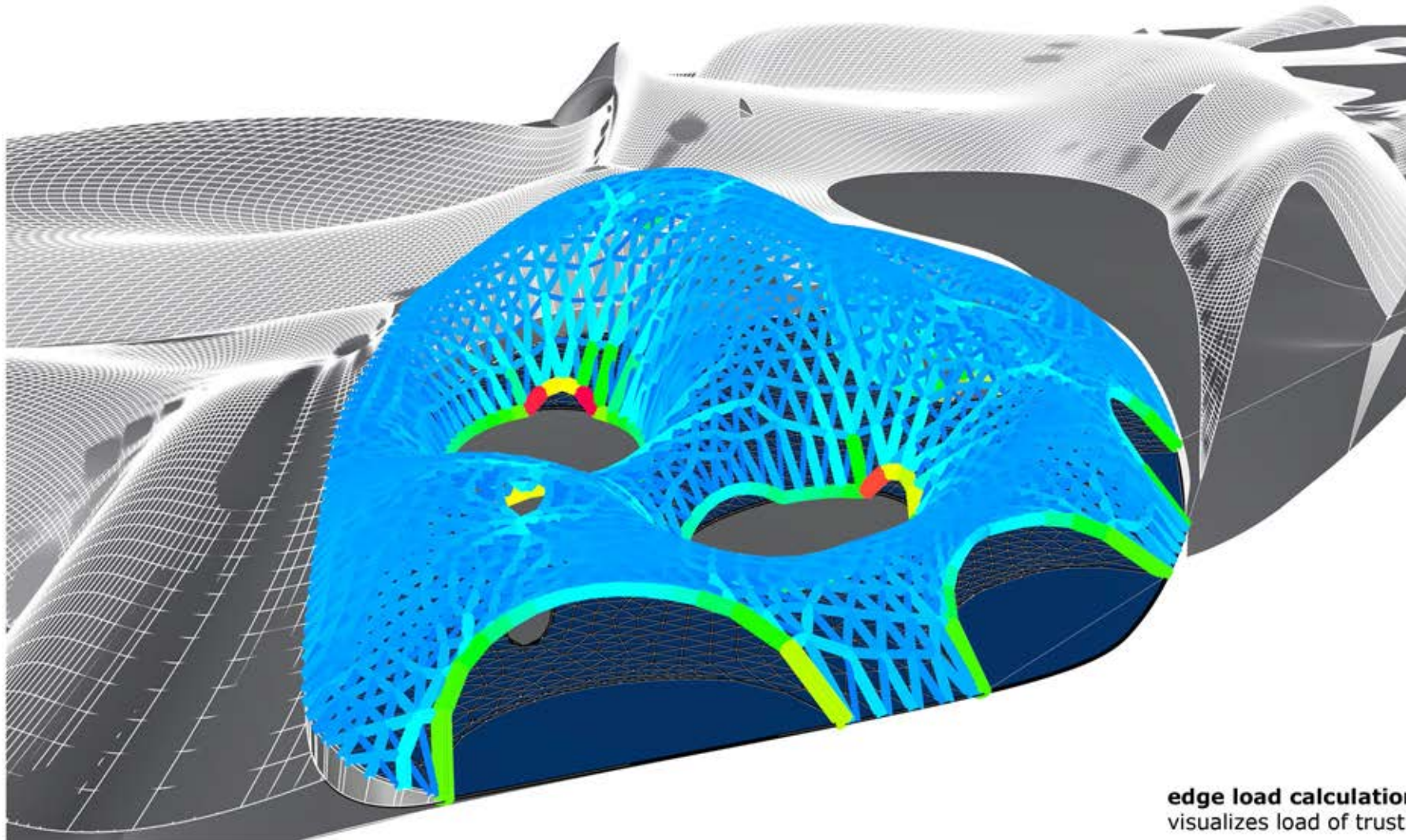

**edge load calculation** - calculates and visualizes load of trust network

**vault definition internal**

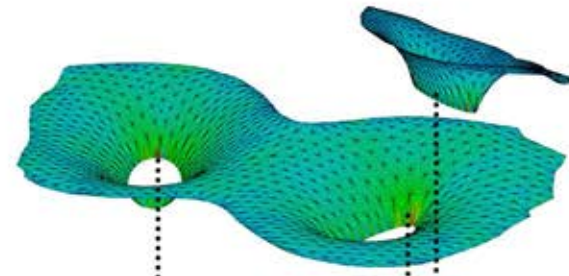

**vault definition external**

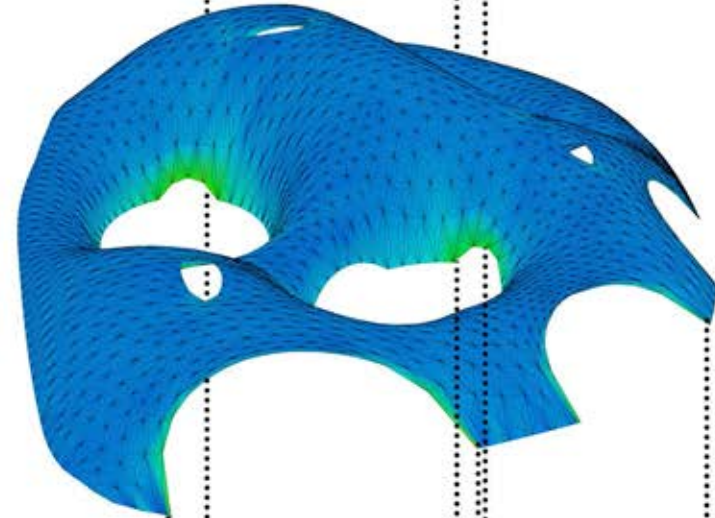

**3d spatial vault configuration**

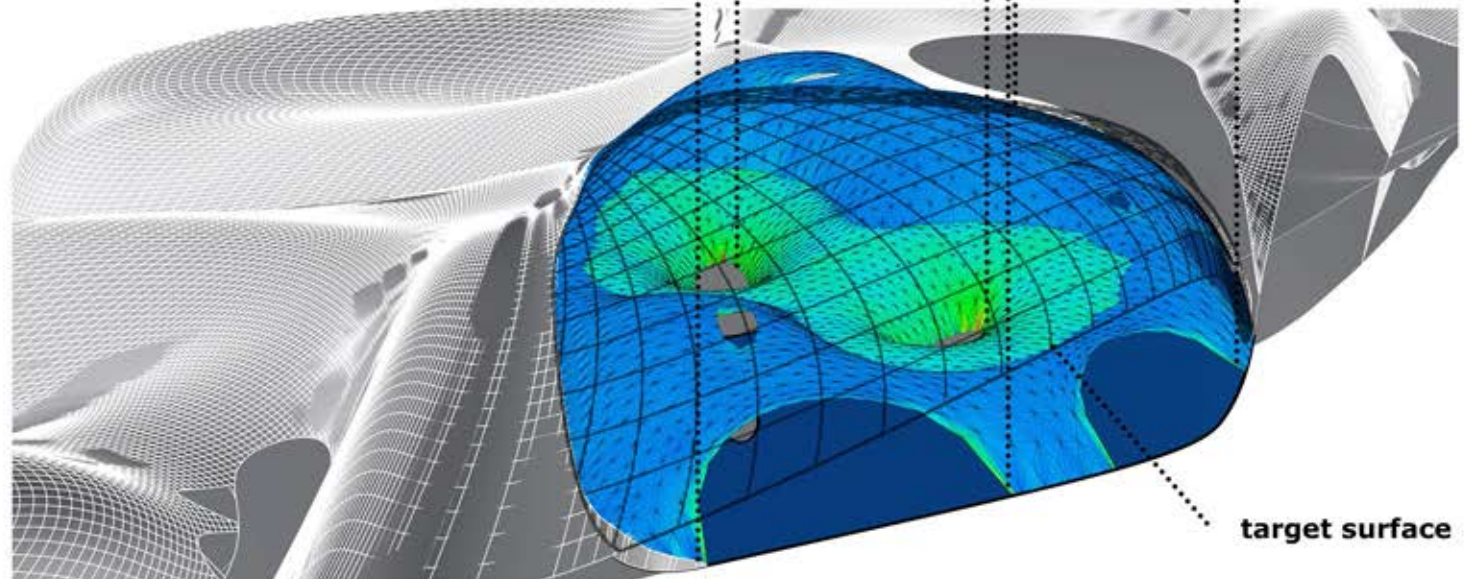

**target surface**

# ARCHITECTURAL CONCEPT

## stonevault composition

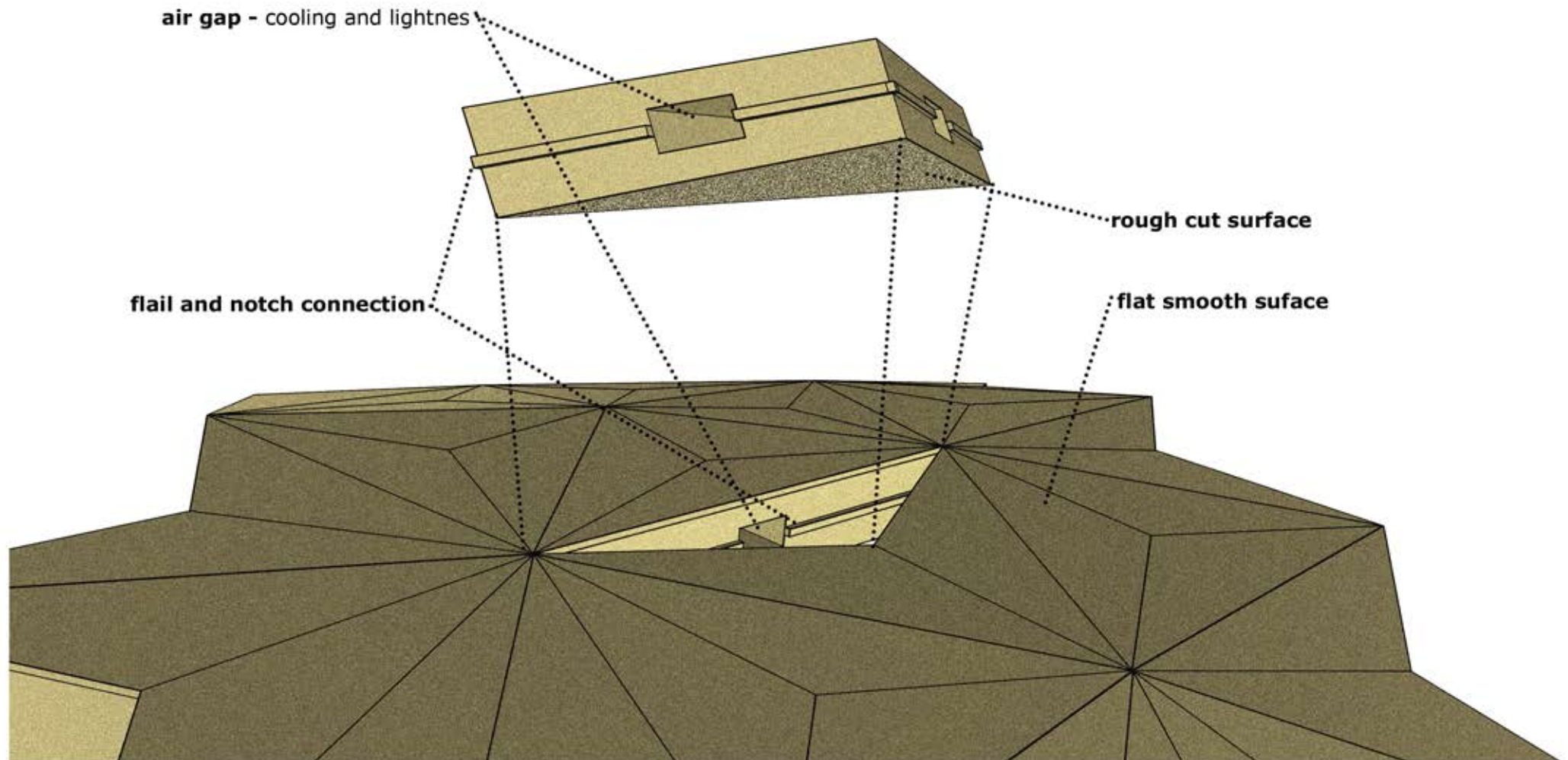



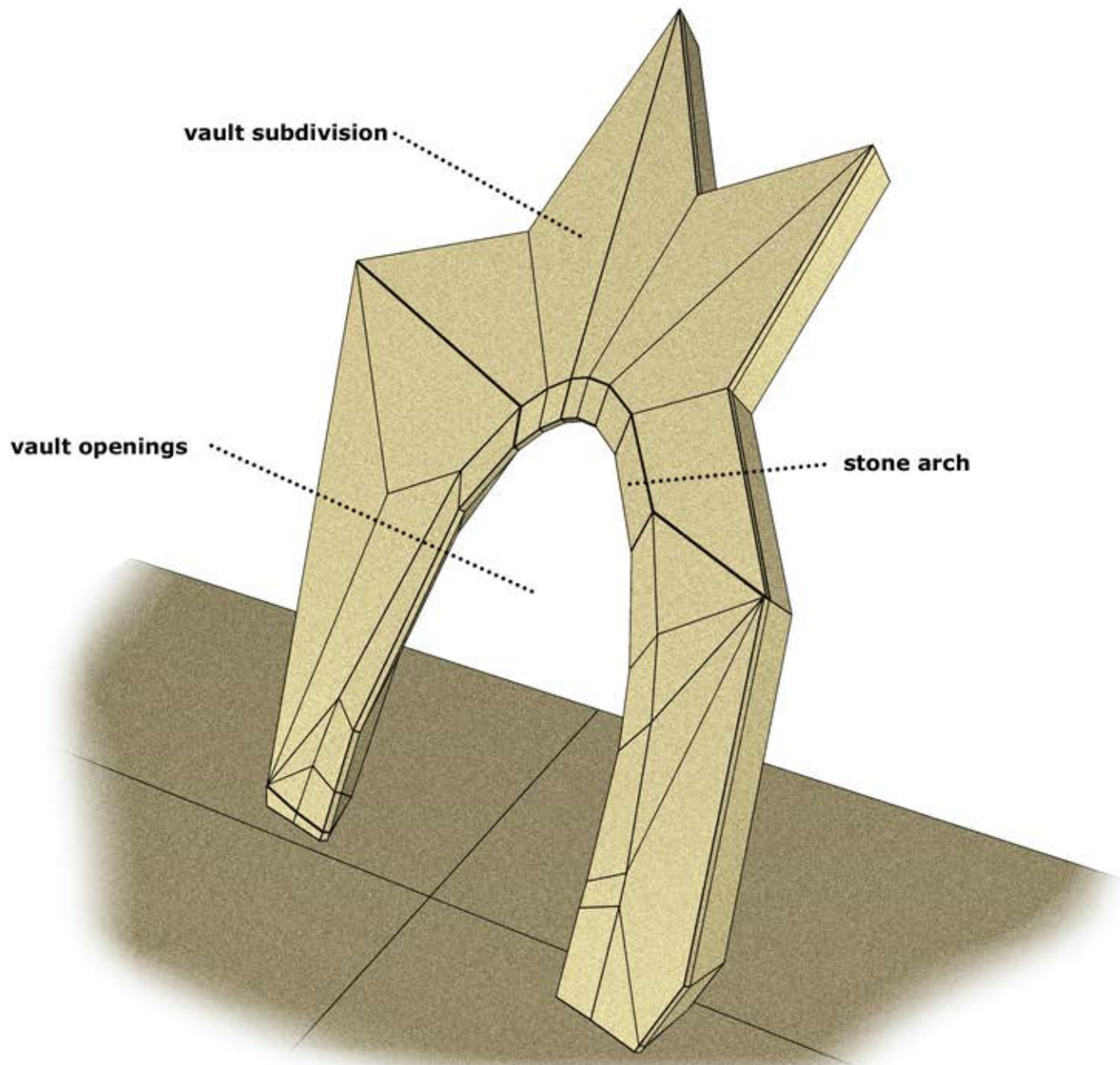

**vault subdivision**

**vault openings**

**stone arch**

# PROJECT DOCUMENTATION

## CFD evaluation air temperature

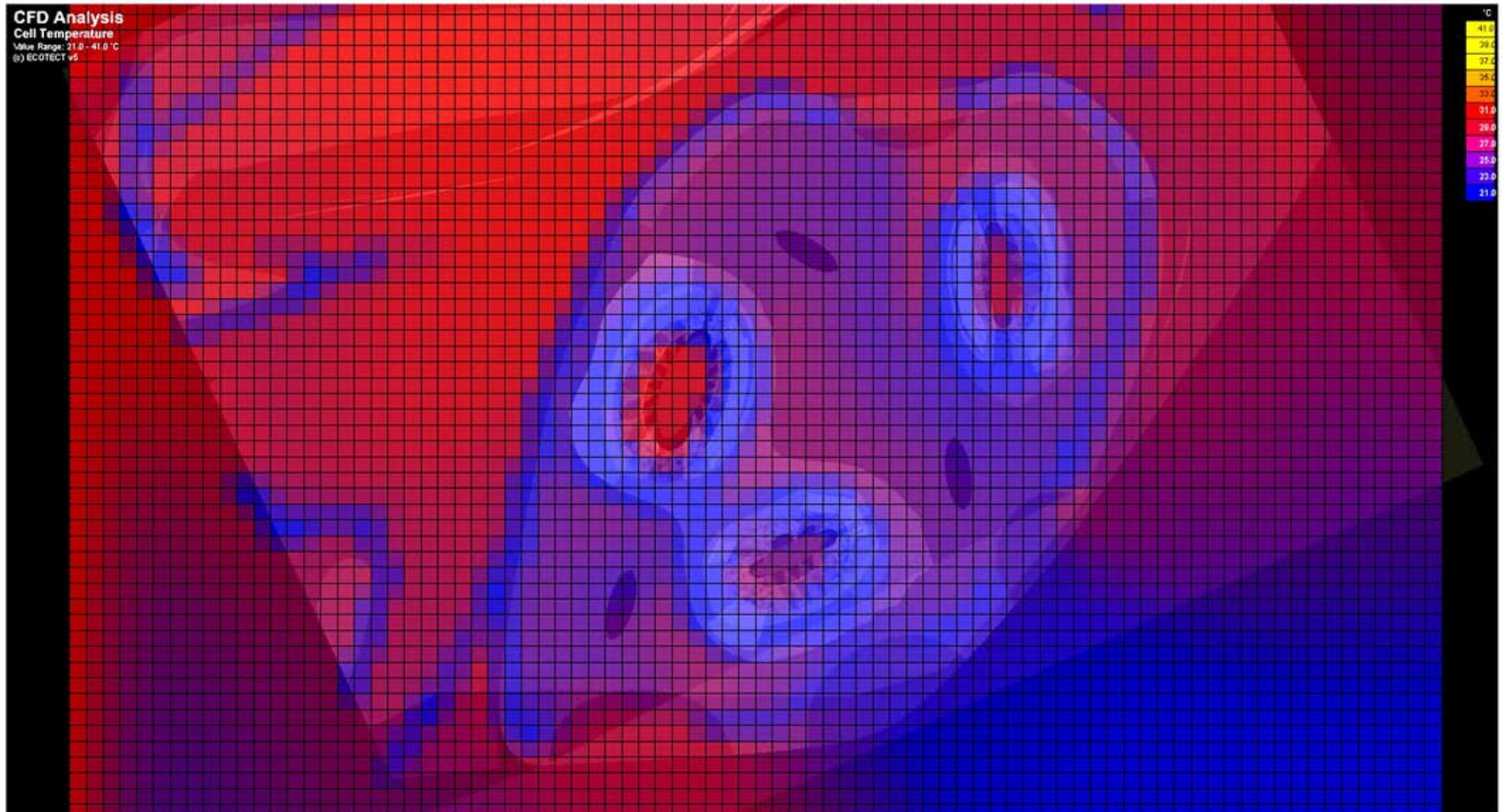

# CFD evaluation

air flow direction

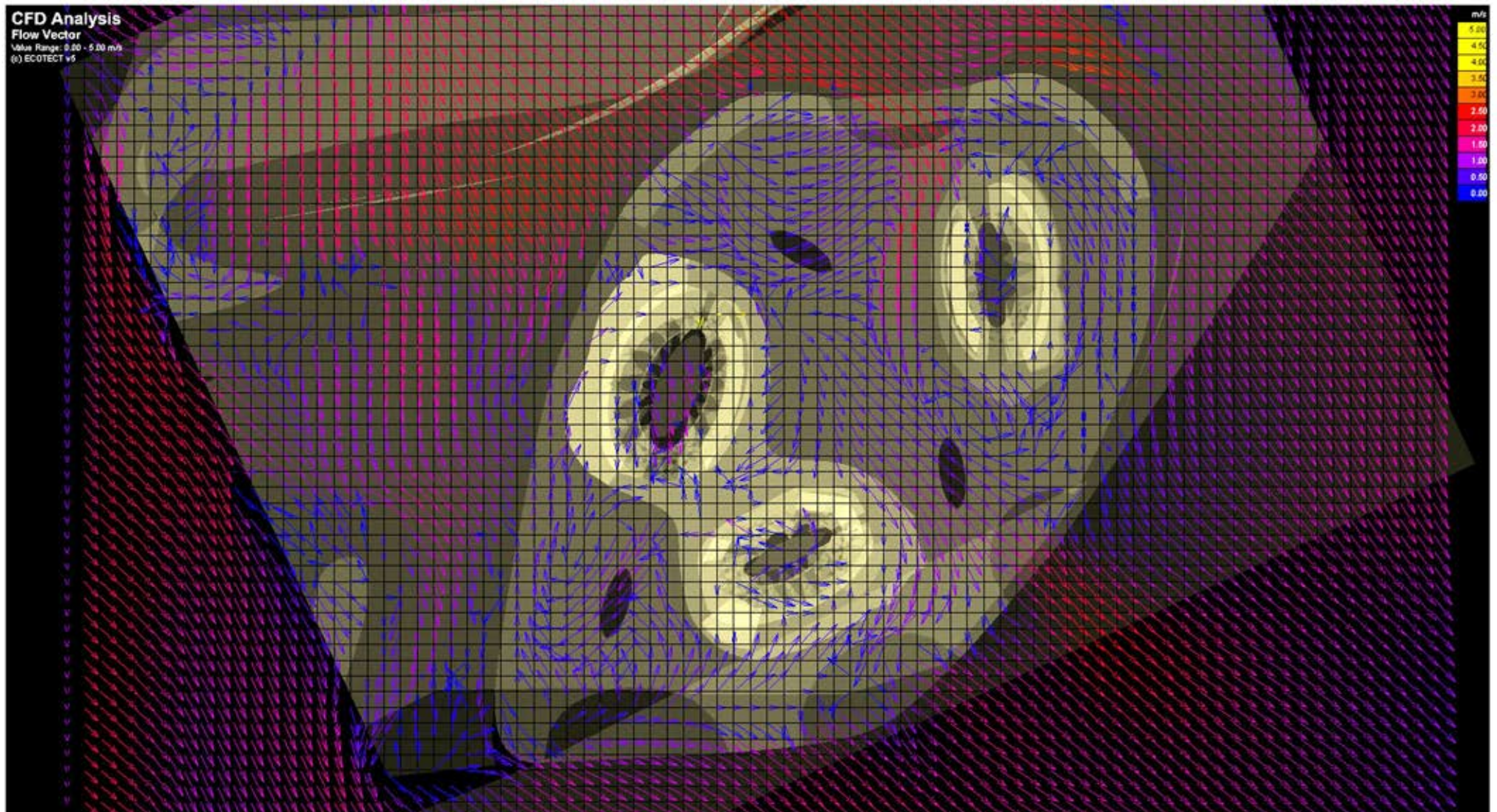

## PROJECT DOCUMENTATION

### CFD evaluation\_LIMIT CONDITIONS

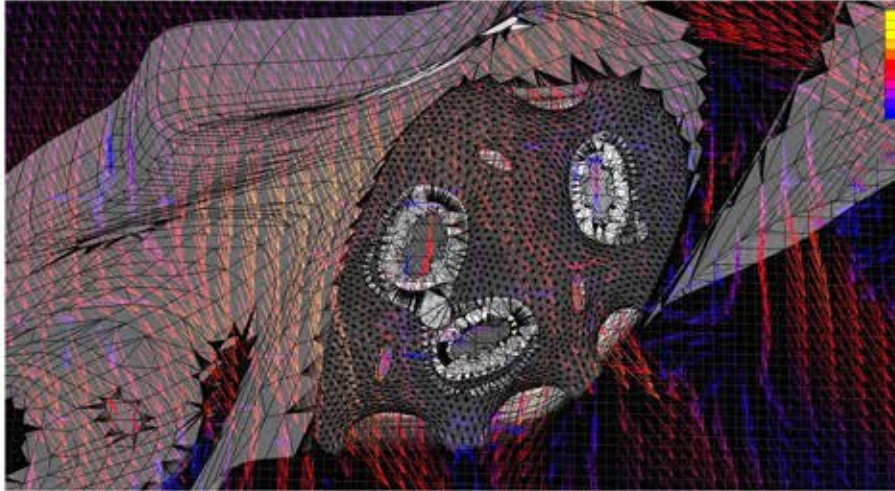

TEMPERATURE 15 °C, WIND SPEED 35 KM/h, WIND DIRECTION - NW

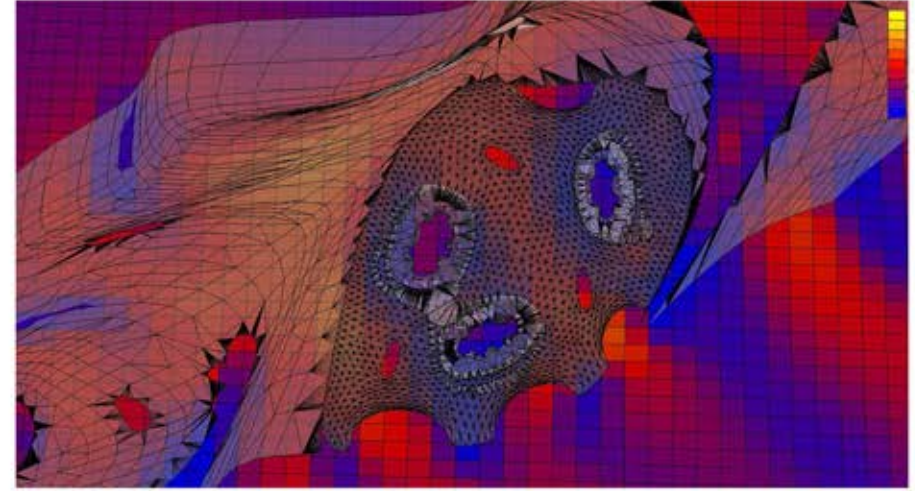

TEMPERATURE 39 °C, WIND SPEED 55 KM/h, WIND DIRECTION - SE

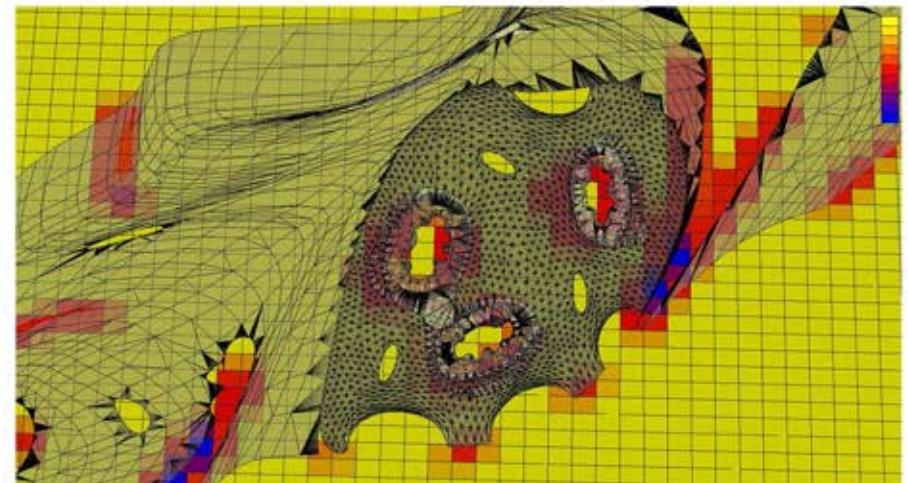
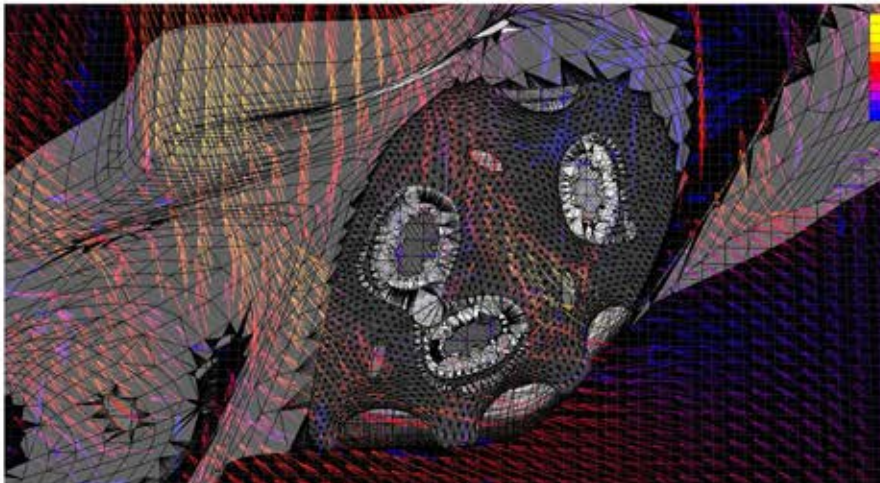

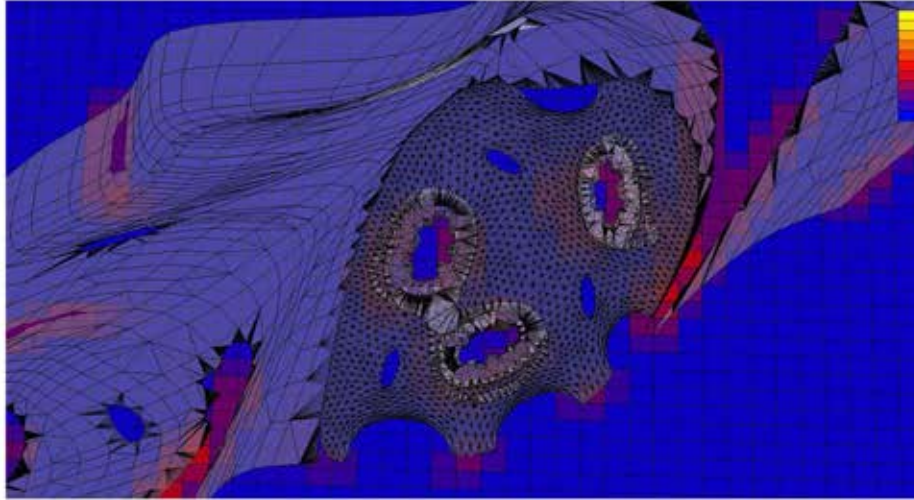

TEMPERATURE 5 °C, WIND SPEED 10 KM/h, WIND DIRECTION - NW

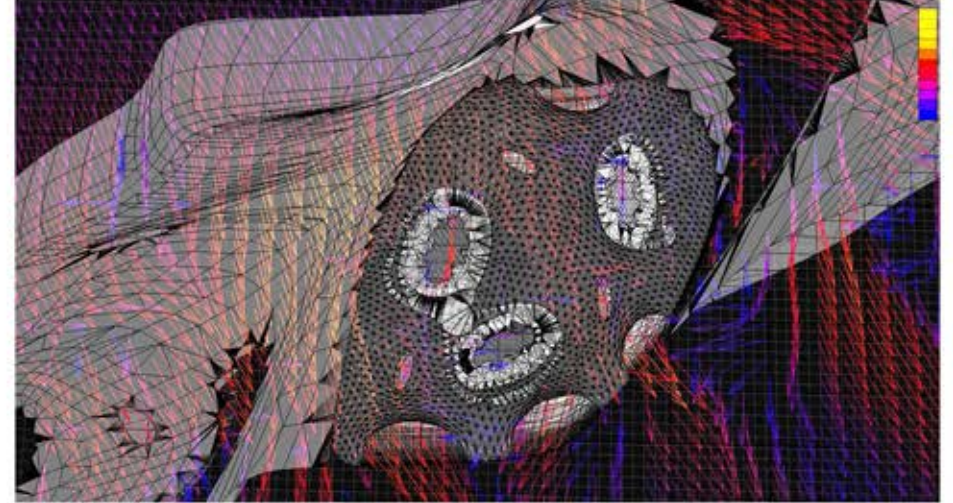

TEMPERATURE 25 °C, WIND SPEED 35 KM/h, WIND DIRECTION - S

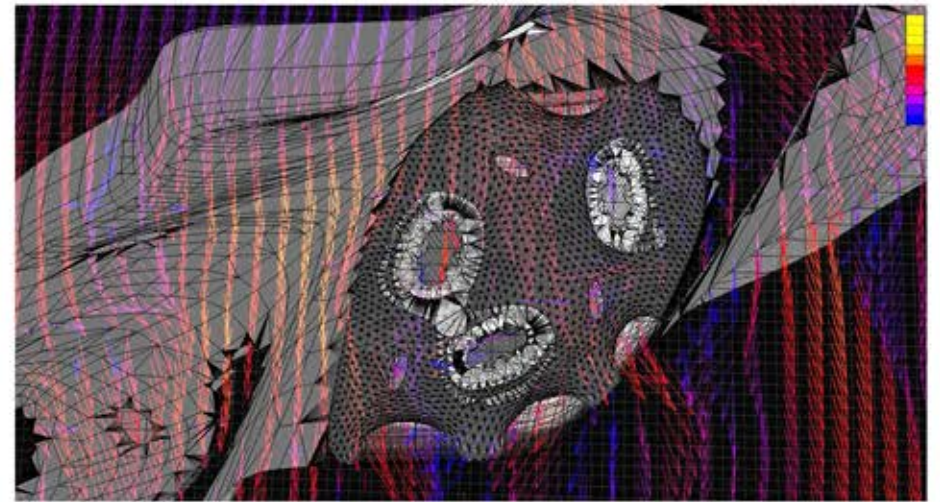
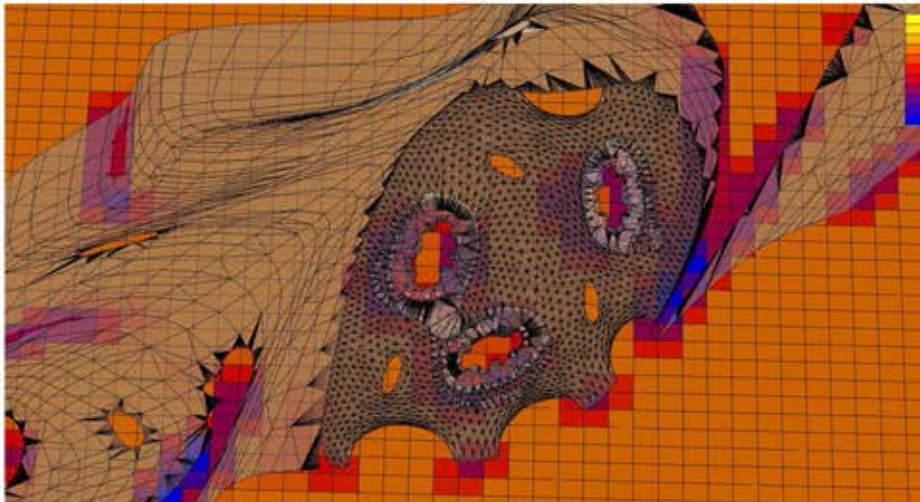

## ARCHITECTURAL CONCEPT

### spatial composition

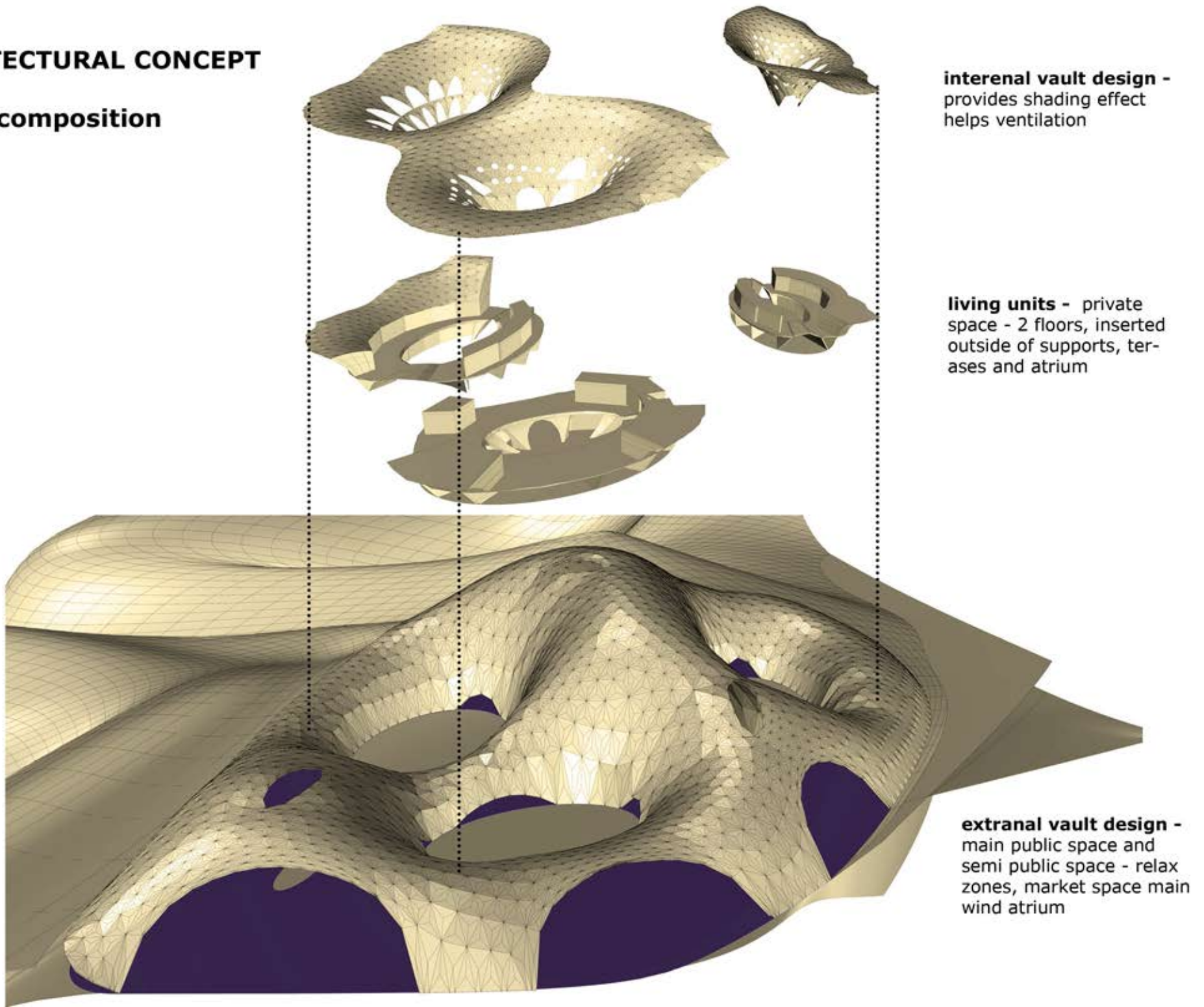

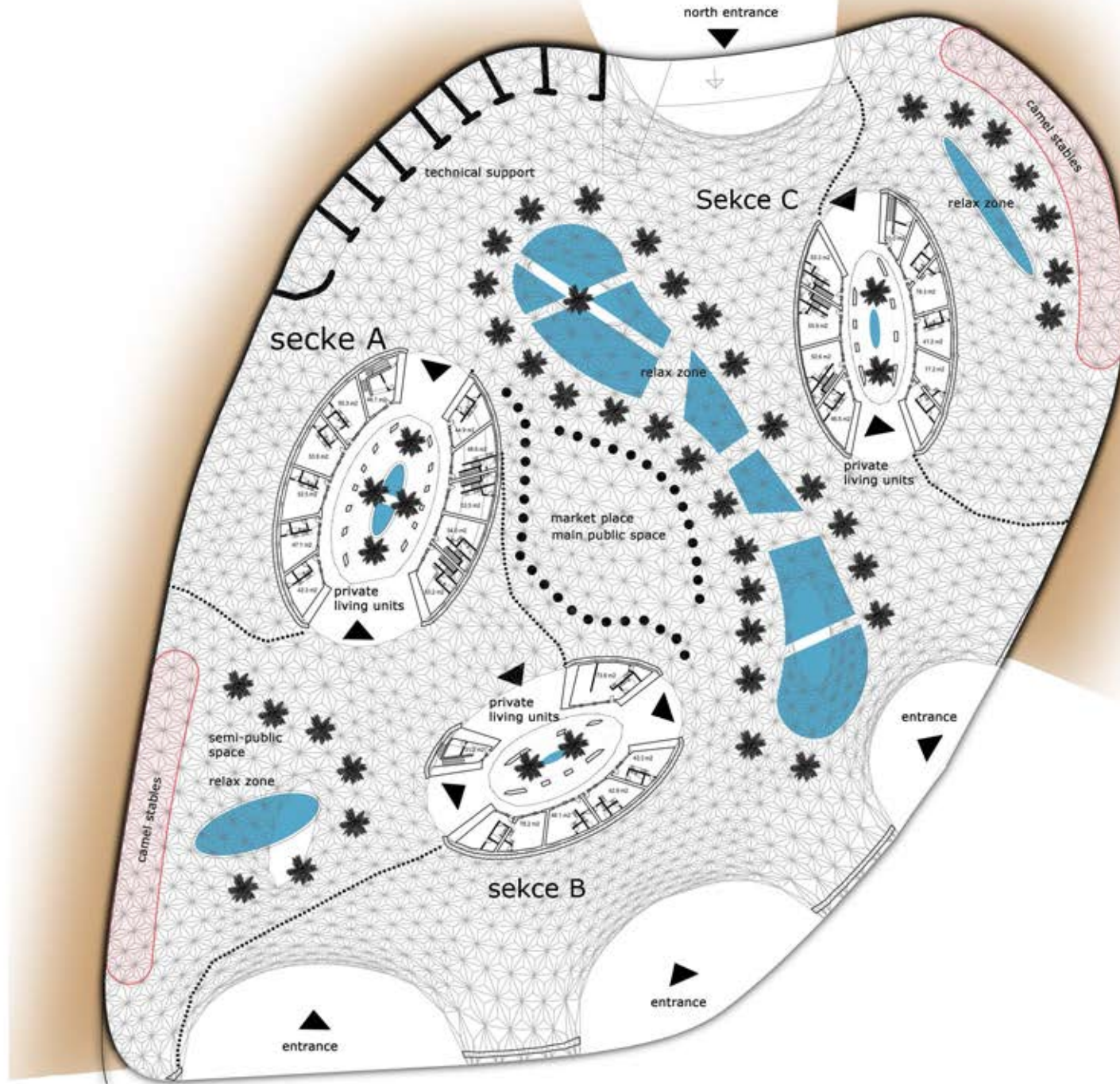

**coordination plan 1. floor**

# PROJECT DOCUMENTATION

## floor plans

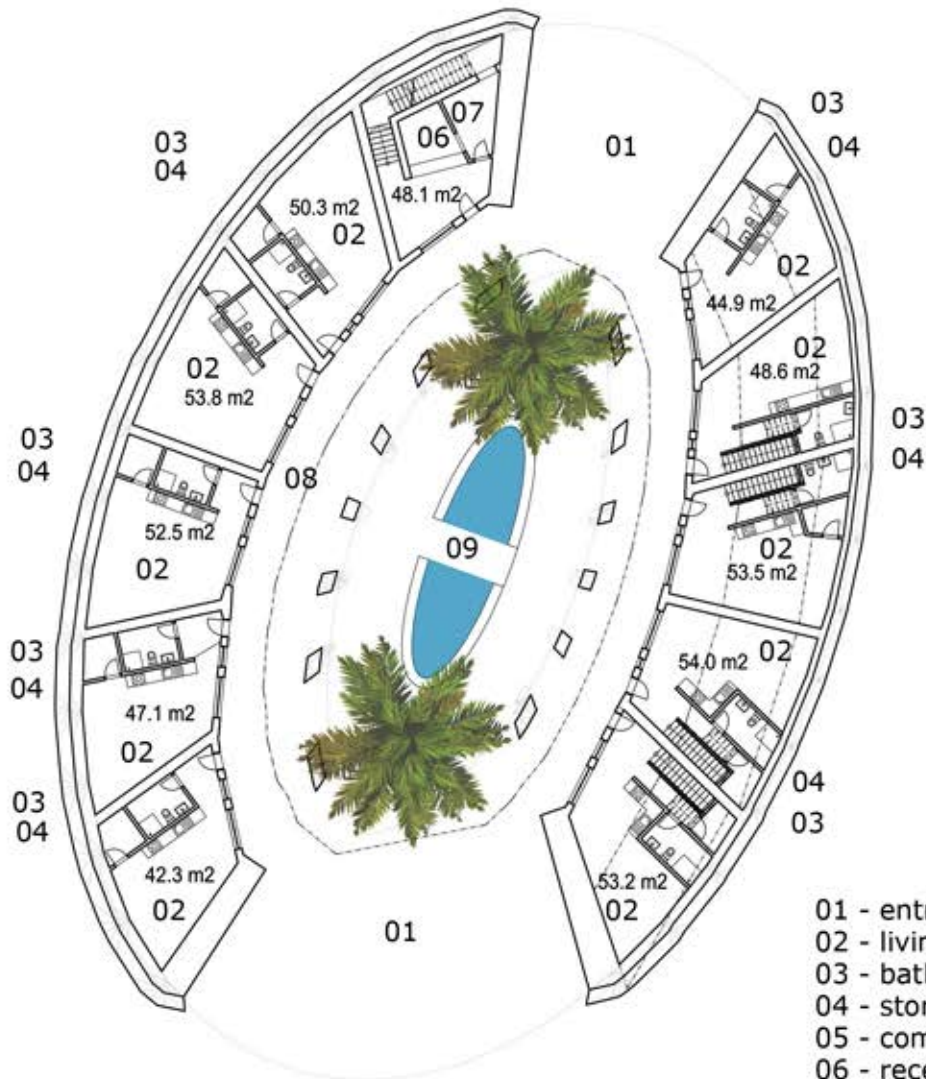

**1. FLOOR**

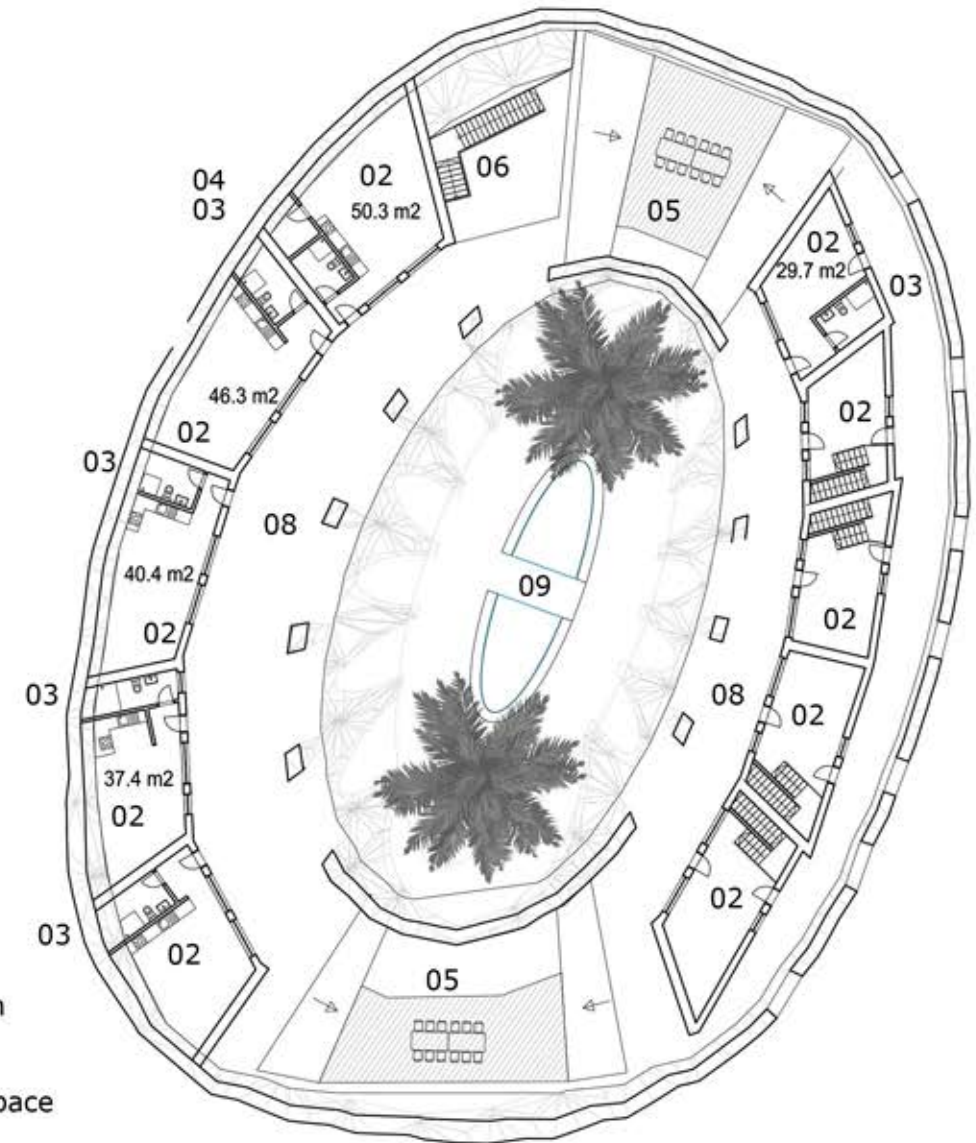

**2. FLOOR**

- 01 - entrance
- 02 - living room
- 03 - bathroom
- 04 - storage
- 05 - comunal space
- 06 - reception
- 07 - technical space
- 08 - Hallway
- 09 - Atrium

**SEKCE A - FLOOR PLANS**



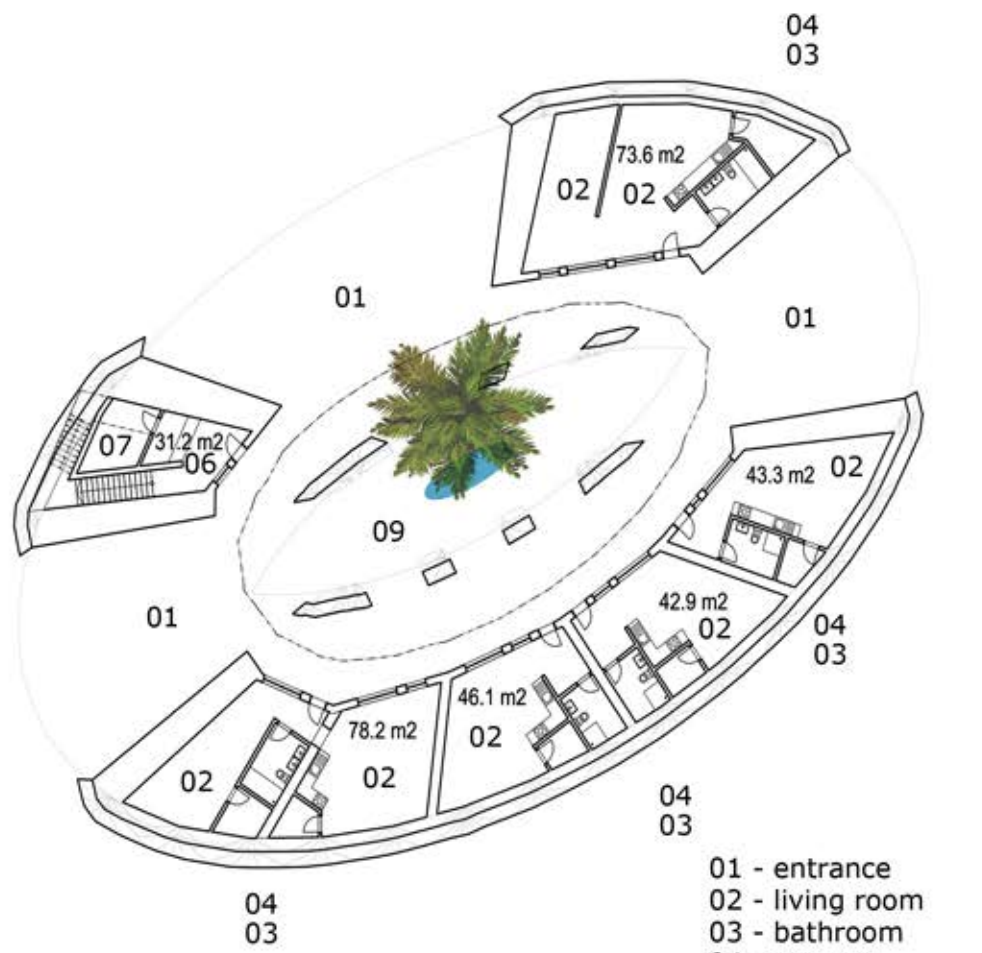

**1. FLOOR**

- 01 - entrance
- 02 - living room
- 03 - bathroom
- 04 - storage
- 05 - comunal space
- 06 - reception
- 07 - technical space
- 08 - Hallway
- 09 - Atrium
- 10 - space for tents

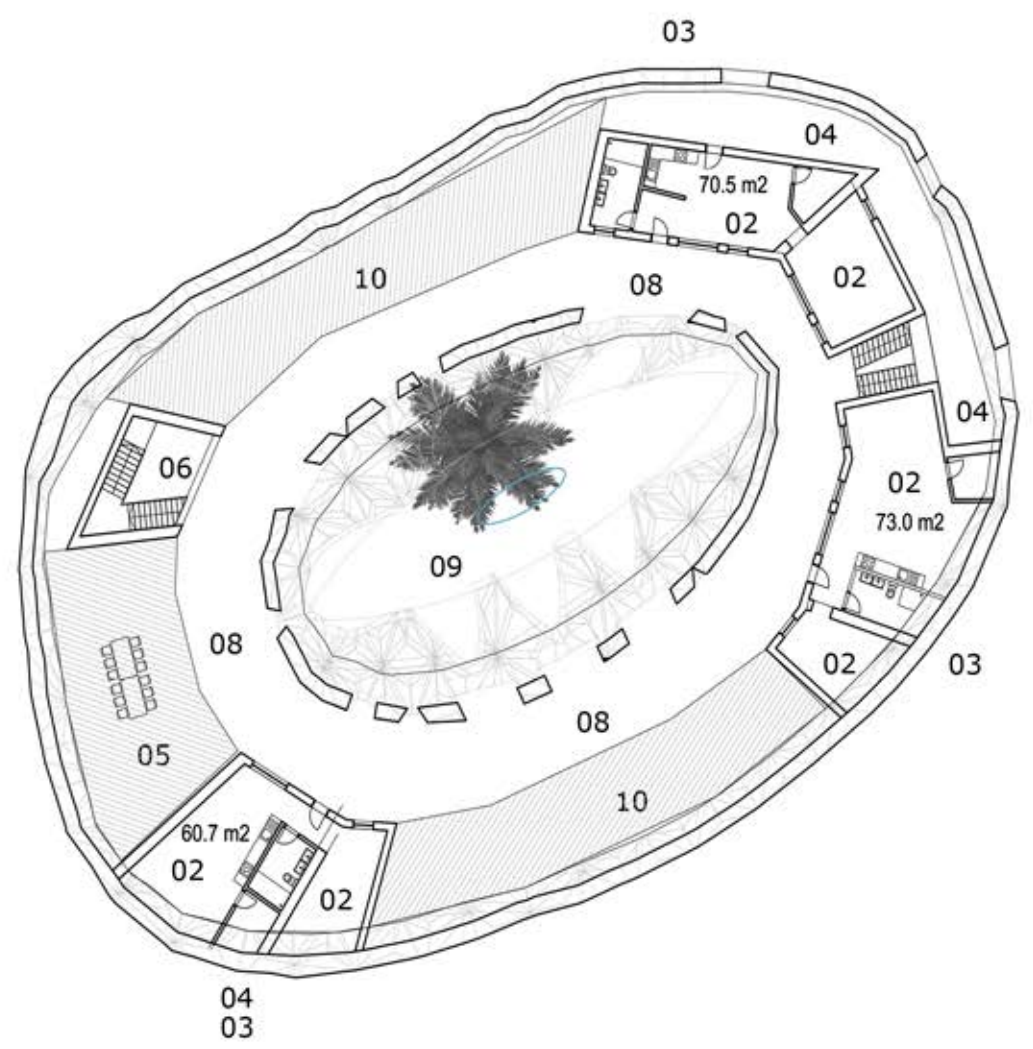

**2. FLOOR**

**SEKCE B - FLOOR PLANS**

# PROJECT DOCUMENTATION

## floor plans

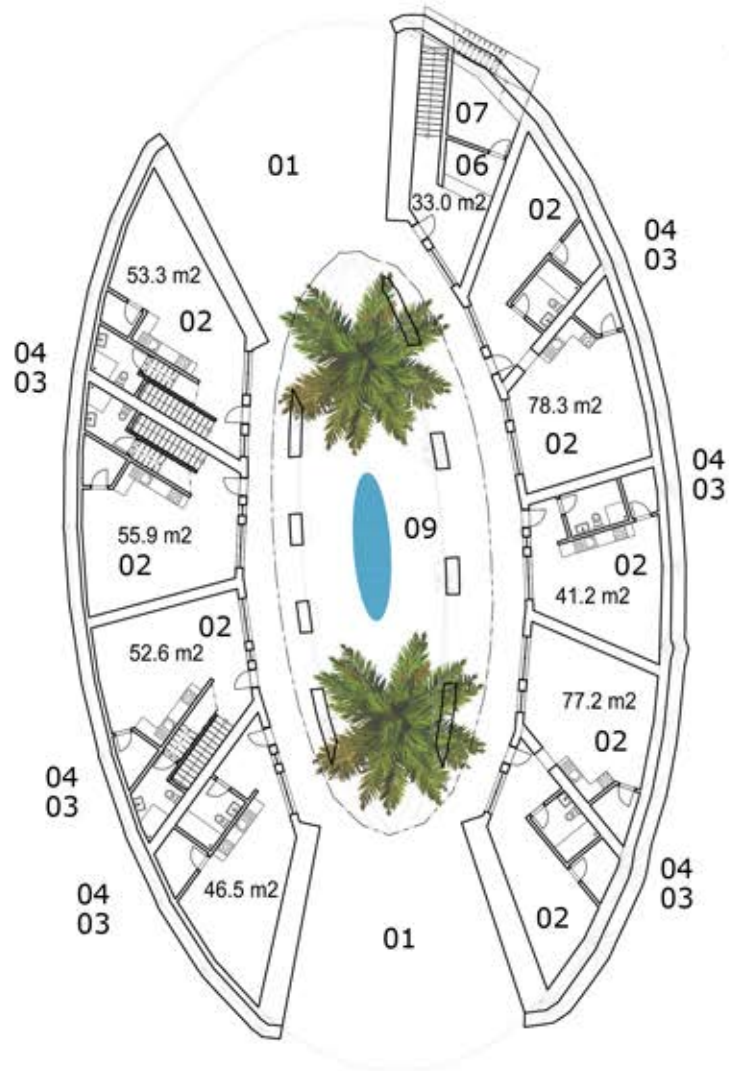

**1. FLOOR**

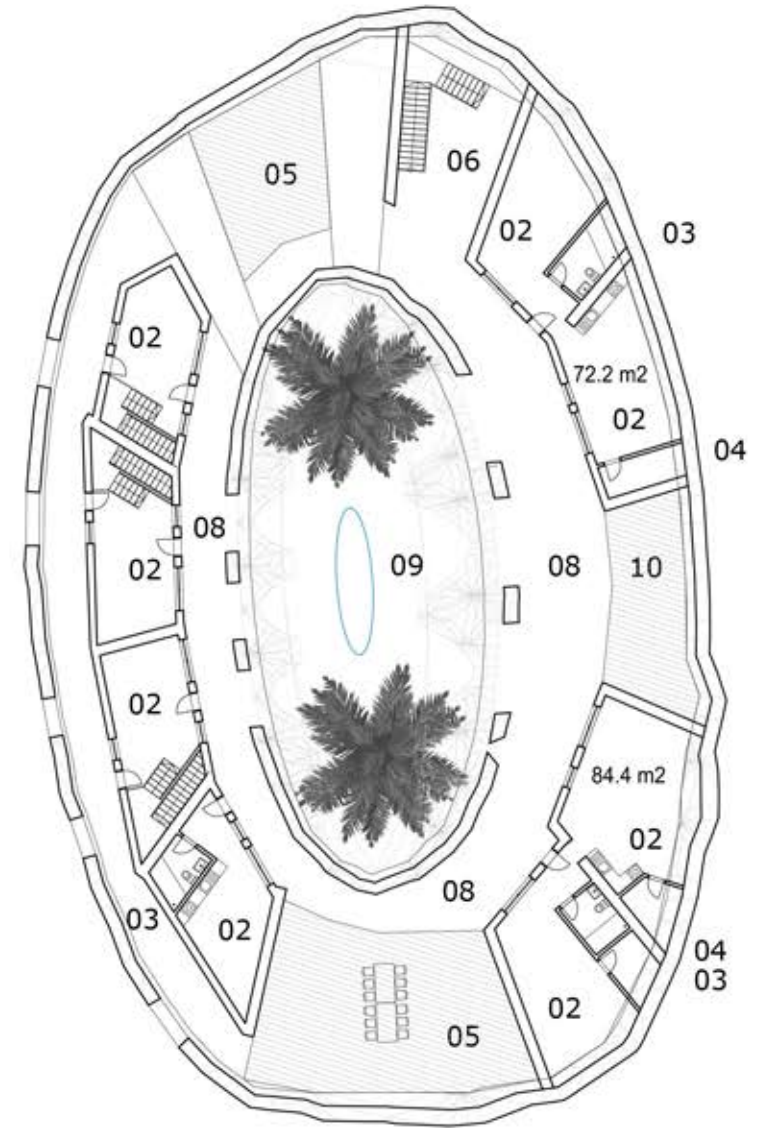

**2. FLOOR**

- 01 - entrance
- 02 - living room
- 03 - bathroom
- 04 - storage
- 05 - comunal space
- 06 - reception
- 07 - technical space
- 08 - Hallway
- 09 - Atrium
- 10 spaces for tents

**SEKCE C - FLOOR PLANS**

# longitudinal section

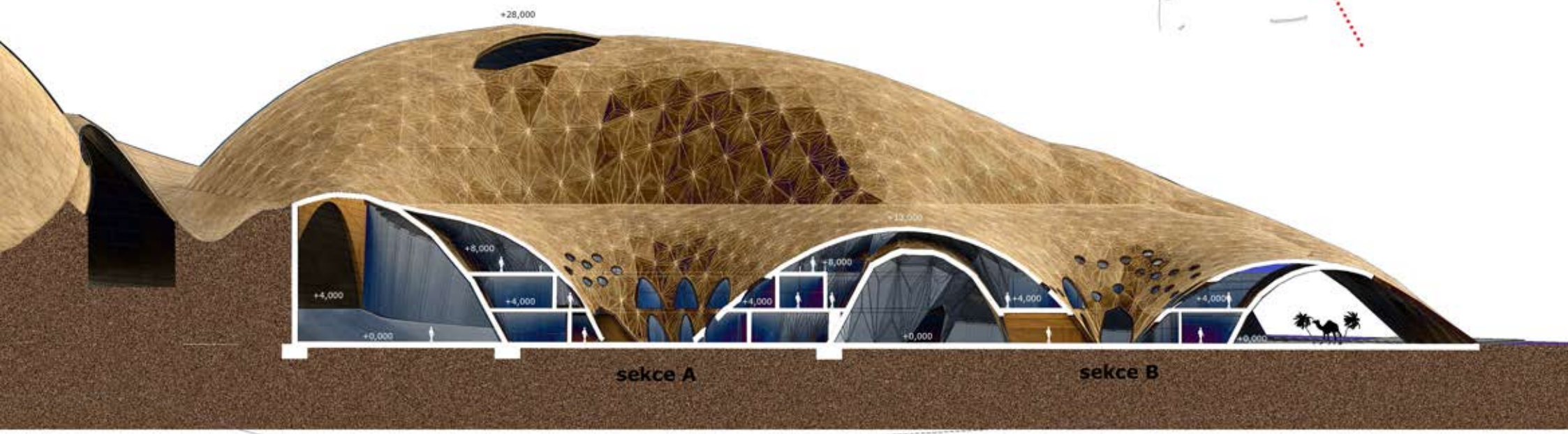
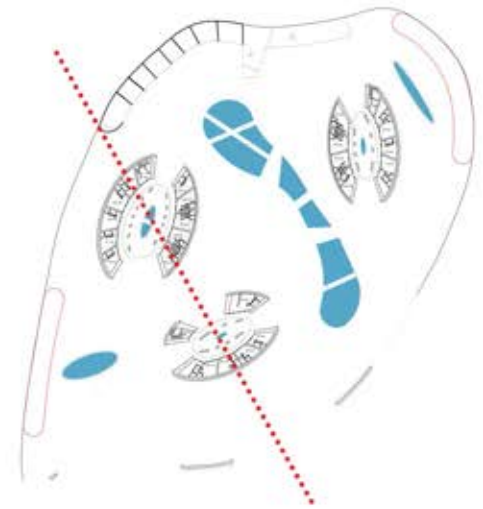

# PROJECT DOCUMENTATION

## cross section

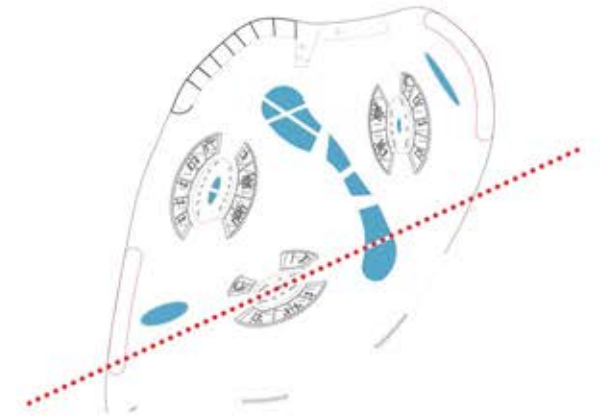

**cross section**

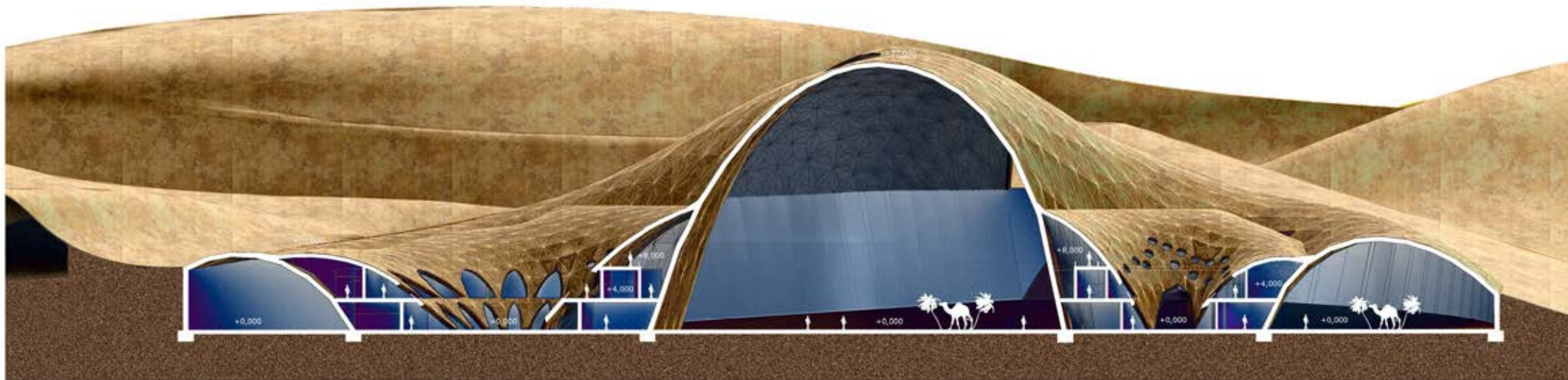
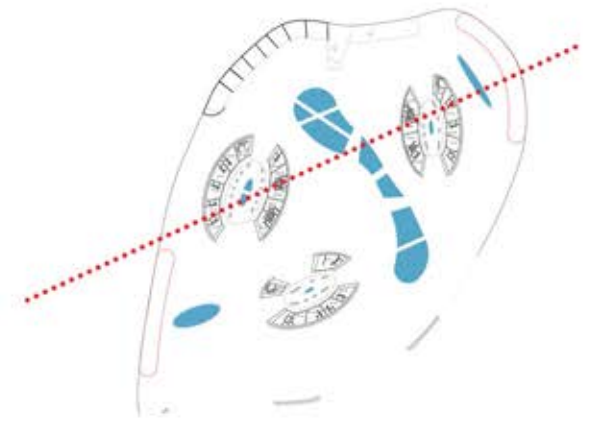

# PROJECT DOCUMENTATION

top elevation

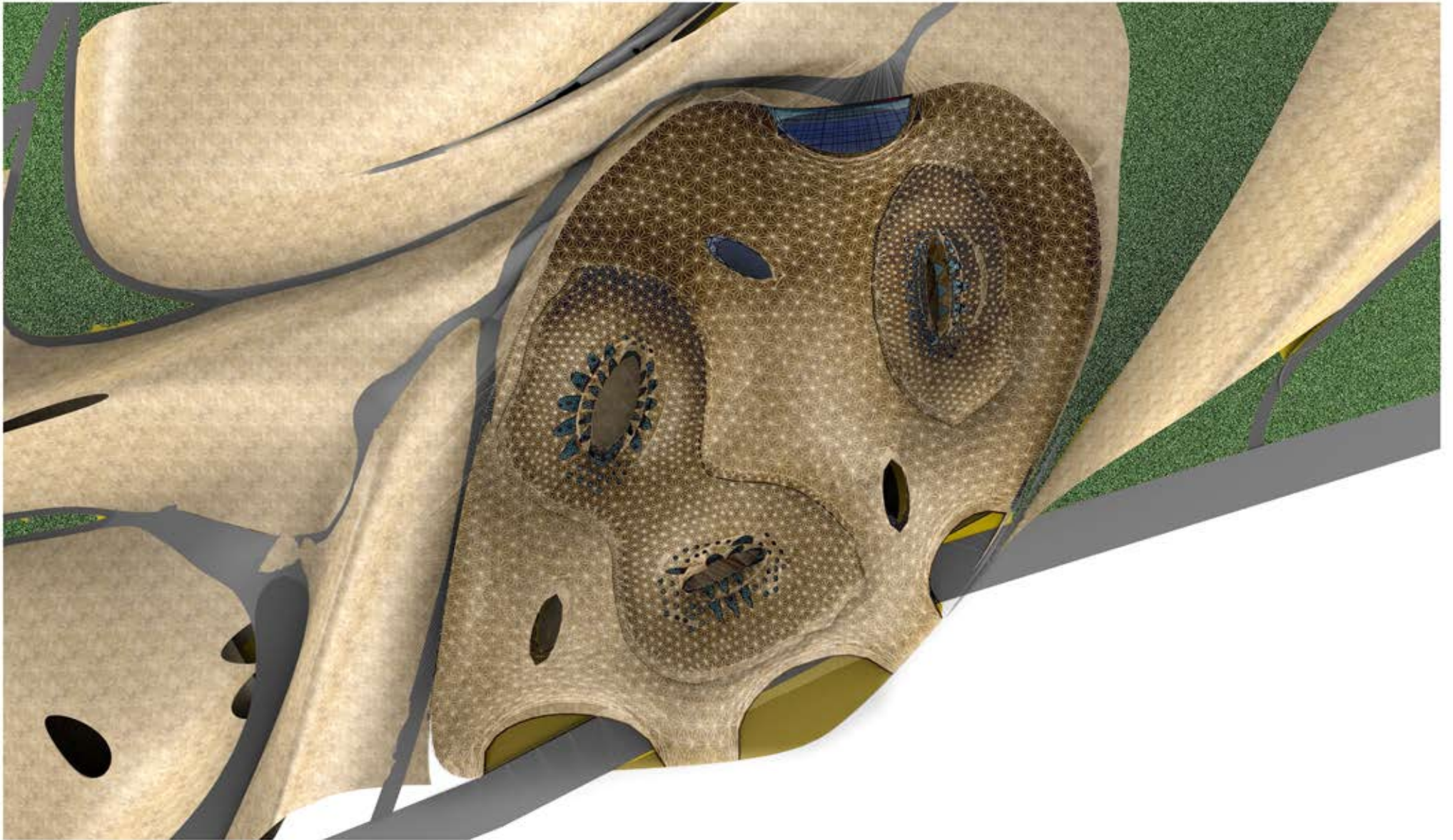

**front elevation**

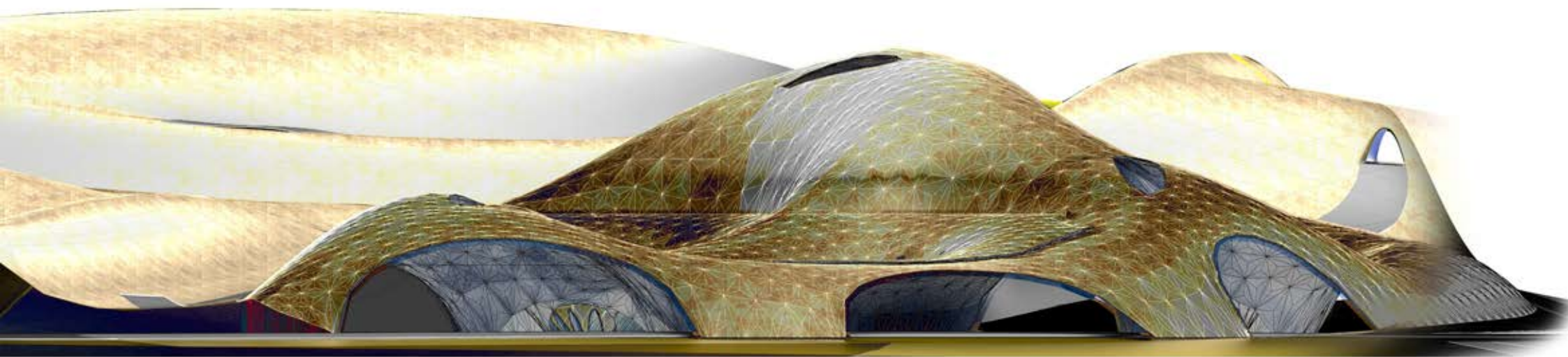

# PROJECT DOCUMENTATION

## exterior visualisation

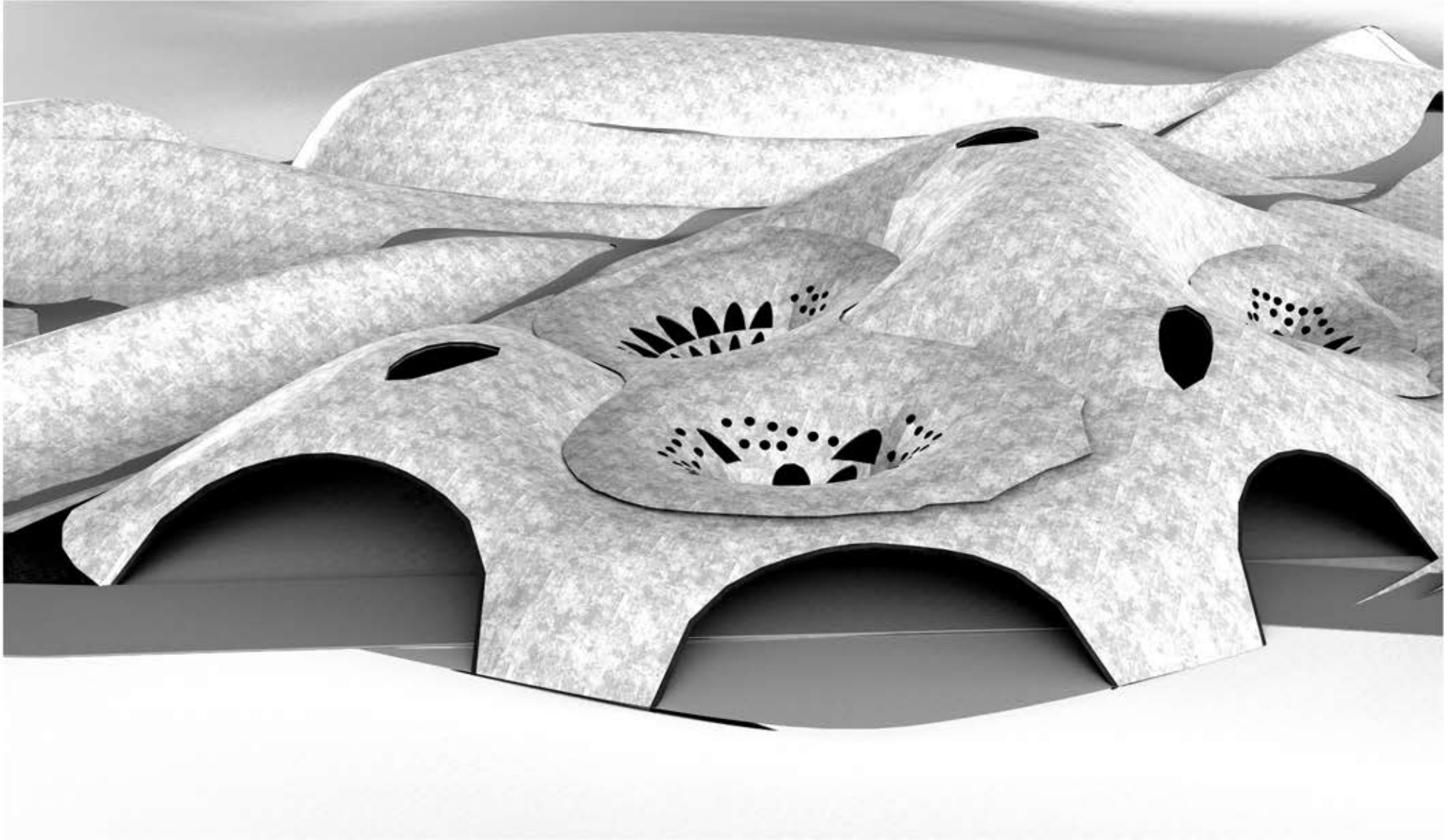



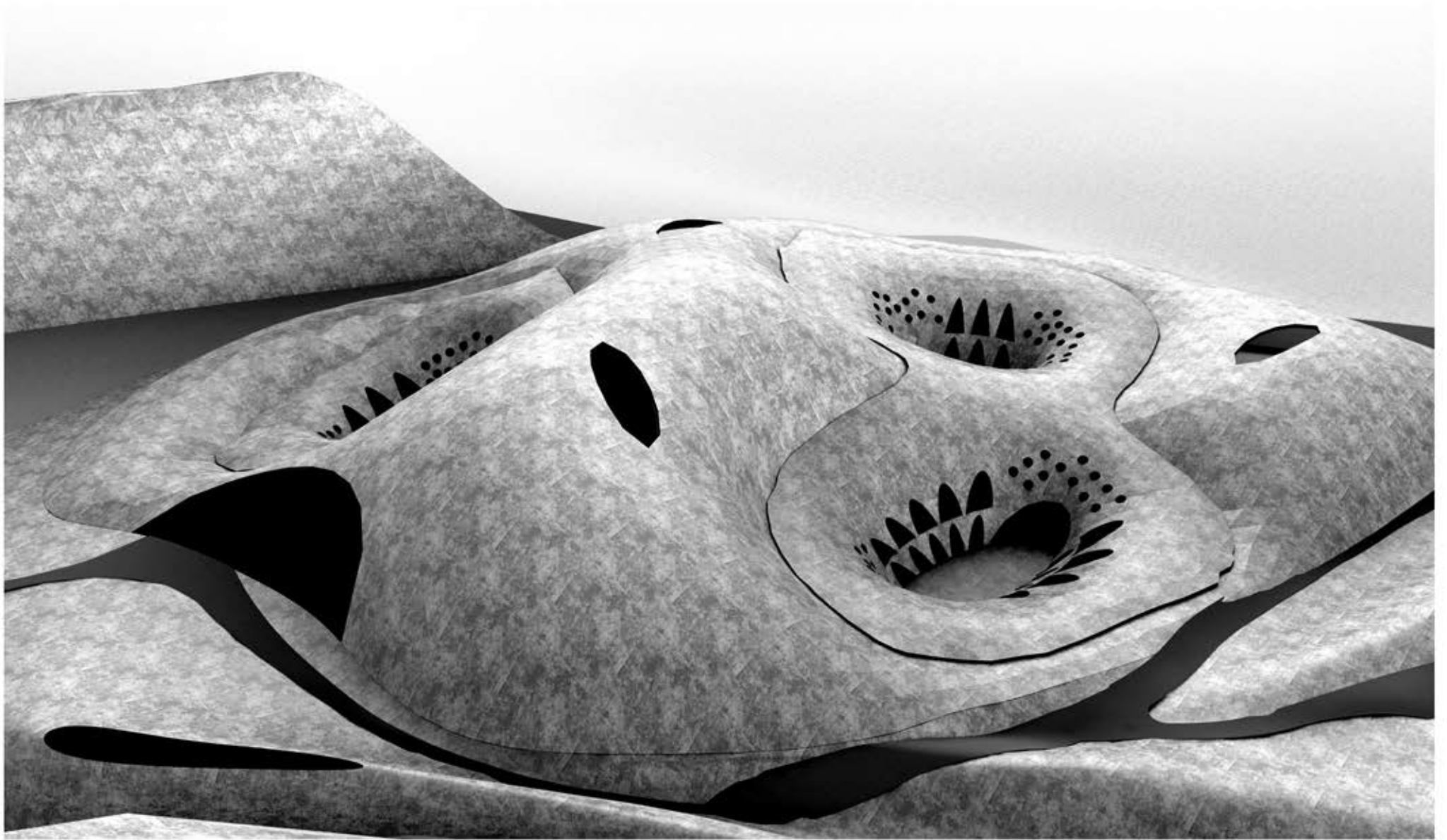

## PROJECT DOCUMENTATION

### interior visualisation





## **thanks to the tutors**

doc. Ing. arch. Miloš Florián, Ph.D  
Ing. arch. Lukas Kurilla  
Ing. arch. Jan Petrš  
Ing. arch. Jindřich Ráftl, Mga

## **consultant**

prof. Ing. Karel Kabele, CSc  
Prof. Ing. Jiří Šejnoha, DrSc.  
doc. Ing. Vít Šmilauer Ph.D.