

CZECH TECHNICAL UNIVERSITY IN PRAGUE

Faculty of Electrical Engineering

BACHELOR'S THESIS



Zdeněk Berka

Analysis of TCAS

Department of Control Engineering

Thesis supervisor: **Ing. Martin Selecký**

I. Personal and study details

Student's name: **Berka Zdeněk** Personal ID number: **456881**
Faculty / Institute: **Faculty of Electrical Engineering**
Department / Institute: **Department of Control Engineering**
Study program: **Cybernetics and Robotics**
Branch of study: **Systems and Control**

II. Bachelor's thesis details

Bachelor's thesis title in English:

Analysis of TCAS

Bachelor's thesis title in Czech:

Analýza systému TCAS

Guidelines:

1. Study the principles of operation of on-board transponders and mechanism of TCAS.
2. Implement the TCAS functionality and verify the correctness of the implementation.
3. Integrate the TCAS into a system for air traffic simulation
4. Enhance the simulation with model of delays caused by RF transmission and pilot reactions
5. Measure the efficiency of the TCAS in various encounter scenarios and with various delays

Bibliography / sources:

- [1] Munoz, C., Narkawicz, A. and Chamberlain, J., 2013, August. A TCAS-II resolution advisory detection algorithm. In Proceedings of the AIAA Guidance Navigation, and Control Conference and Exhibit.
- [2] Billingsley, T.B., 2006. Safety analysis of TCAS on Global Hawk using airspace encounter models. MASSACHUSETTS INST OF TECH CAMBRIDGE DEPT OF AERONAUTICS AND ASTRONAUTICS.
- [3] Kochenderfer, M.J., Espindle, L.P., Kuchar, J.K. and Griffith, J.D., 2008. A comprehensive aircraft encounter model of the national airspace system. Lincoln Laboratory Journal, 17(2), pp.41-53.
- [4] Billingsley, T.B., Espindle, L.P. and Griffith, J.D., 2009. TCAS multiple threat encounter analysis. Massachusetts Institute of Technology, Lincoln Laboratory, Project Report ATC-359.
- [5] Kochenderfer, M.J., Espindle, L.P., Edwards, M.W., Kuchar, J.K. and Griffith, J.D., 2009. Airspace encounter models for conventional and unconventional aircraft. In Proceedings of 8th USA/Europe Air Traffic Management Research and Development Seminar, USA.

Name and workplace of bachelor's thesis supervisor:

Ing. Martin Selecký, Department of Computer Science and Engineering, FEE

Name and workplace of second bachelor's thesis supervisor or consultant:

Date of bachelor's thesis assignment: **16.01.2018** Deadline for bachelor thesis submission: **25.05.2018**

Assignment valid until: **30.09.2019**

Ing. Martin Selecký
Supervisor's signature

prof. Ing. Michael Šebek, DrSc.
Head of department's signature

prof. Ing. Pavel Ripka, CSc.
Dean's signature

III. Assignment receipt

The student acknowledges that the bachelor's thesis is an individual work. The student must produce his thesis without the assistance of others, with the exception of provided consultations. Within the bachelor's thesis, the author must state the names of consultants and include a list of references.

Date of assignment receipt

Student's signature

Declaration

I declare that the presented work was developed independently and that I have listed all sources of information used within it in accordance with the methodical instructions for observing the ethical principles in the preparation of university theses.

Prague, date

.....
signature

Acknowledgements

Foremost, I would like to to thank my supervisor Ing. Martin Selecký for his guidance and amazingly prompt responses whenever I hit an obstacle and asked him for advice during the creation of this work. I also want to thank Ing. Tomáš Blovký for helping me understand and use the AgentFly simulation system whenever I got lost within its lines of code. I would also like to thank everyone who supported me during my studies and while I was writing my bachelor's thesis.

Abstract

This thesis focuses on analysing the collision avoidance system called TCAS. We implement the TCAS functionality and a parametrised model of the pilot response and introduce methods to verify its functionality. We introduce a parametrised model of aircraft encounters for the purpose of simulation. First, the collision avoidance logic functionality is tested and verified in a discrete simulation using various scenarios. Then, the collision avoidance system is integrated within an air traffic simulation using the precise BADA aircraft dynamics model and the parametrised pilot response model which allows the testing of various reaction delays. Both single and multiple-threat encounters and both uncoordinated and TCAS-TCAS encounters are simulated, and delay-related limitations of the collision avoidance system's functionality are estimated.

Abstrakt

Práce se soustředí na analýzu palubního protisrážkového systému TCAS. Popisuje implementaci parametrizovaného modelu reakcí pilota, TCAS mechanismu a metody použité k ověření funkčnosti protisrážkového systému. Dále je popsán parametrizovaný model pro střetnutí letadel v leteckém prostoru, který je použit pro generování scénářů pro testování funkčnosti protisrážkového systému. Nejdříve je systém otestován v jednoduché diskretní simulaci použitím různorodých scénářů. Poté je protisrážková logika integrována do simulace leteckého provozu, která používá přesné BADA modely dynamiky letounů. Pro kontrolu letounu je zde integrován parametrizovaný model reakcí pilota, který umožňuje testovat různé typy zpoždění. Nekoordinované i TCAS-TCAS střety s jedním i více cizími letouny jsou odsimulovány k prozkoumání efektu parametrů zpoždění na schopnosti protisrážkového systému udržet separaci.

Contents

1	Introduction	1
1.1	Motivation and Goals	1
1.2	Structure	2
2	Air Traffic Surveillance	3
2.1	Transponder Interrogation Modes	3
2.1.1	Mode A/C without Altitude Reporting	3
2.1.2	Mode C	3
2.1.3	Mode S	4
2.1.4	Automatic Dependent Surveillance-Broadcast (ADS-B)	4
2.1.5	TCAS Interaction with Transponders	5
3	TCAS Description	7
3.1	Threat Detection	8
3.1.1	Advisories Concept	8
3.1.2	Issuance Conditions	9
3.1.3	Threshold Parameters	10
3.2	Conflict Resolution	11
3.2.1	RA Type Selection	12
3.2.2	RA Sense Selection	12
3.2.3	Multiple-threat Encounters	14
3.3	Coordinated Encounters	15
4	TCAS Analysis Methodology	17
4.1	Verification Techniques Overview	17
4.2	Computational Simulation Analysis	17
4.2.1	Collision Avoidance Logic Model	18
4.2.2	TCAS Functionality Metrics	18
4.2.3	Encounter Modelling	18
4.2.4	Aircraft Dynamics Models	19
4.2.5	Pilot Response Model	21
4.2.6	Air Traffic Model	21

5	TCAS Mechanism Implementation	22
5.1	Advisory Detection Logic	22
5.1.1	Verification	24
5.2	RA Type Selection	27
5.2.1	Verification	29
5.3	RA Sense and ROCD Selection	32
5.3.1	Verification	32
5.4	Composition of the TCAS Logic	36
6	Discrete Encounter Simulation	38
6.1	Encounter Definition	38
6.2	Single-threat Encounters	41
6.3	Reaction to Intruder’s Manoeuvres	44
6.4	Multiple-threat Encounters	45
7	Collision Avoidance Logic Integration within the Air Traffic Simulation	50
7.1	Entity Structure	50
7.1.1	TCAS2 Pilot Module	51
7.2	Encounter Simulation	51
7.2.1	Single-threat Encounters	51
7.2.2	Multiple-threat Encounters	58
7.3	Discussion of Results	60
8	Conclusion	63

List of Figures

2.1	ADS-B communication illustration (borrowed from [16])	5
2.2	Area coverage of a TIS-B service around target aircraft (borrowed from [1]) .	5
3.1	Illustration of the TCAS display of advisories (borrowed from [5])	7
3.2	Illustration of threat detection volume around the ownship (borrowed from [10])	8
3.3	Illustration of thresholds forming the advisory detection area — the TAU threshold is compared with the time to CPA approximation (τ_{mod}) and with the time to co-altitude, DMOD and ZTHR thresholds are compared with horizontal and vertical distance, respectively. Aircraft within the area violate the separation and are considered to be intruders	9
3.4	Illustration of trajectories in which the τ_{mod} concept is needed	10
3.5	Preventive RA example situation	12
3.6	Selection of non-crossing RA sense (borrowed from [23])	13
3.7	Reversal RA invoked by the threat's change in the rate of descend (borrowed from [23])	13
3.8	Multiple-threat encounter illustration	15
3.9	Diagram of coordination process between two TCAS-equipped aircraft	16
5.1	Advisory issuance logic diagram	23
5.2	RA detection visualisation for zero relative velocity vector in Scenario 1 . . .	25
5.3	RA detection visualisation for the relative horizontal velocity of 120 knots in Scenario 2	26
5.4	RA detection visualisation for the relative horizontal velocity of 390 knots and the relative ROCD of -3000 feet/min in Scenario 3	28
5.5	RA type selection logic diagram	29
5.6	RA type selection visualisation for the relative horizontal velocity of 195 knots	30
5.7	RA type selection visualisation for the relative horizontal velocity of 195 knots and the ROCD of 1000 feet/min	30
5.8	RA type selection visualisation for the relative horizontal velocity of 195 knots and the relative ROCD of -3000 feet/min	31
5.9	RA ROCD and sense selection logic diagram	33
5.10	RA sense selection visualisation for the relative horizontal velocity of 195 knots	34
5.11	RA sense selection visualisation for the relative horizontal velocity of 390 knots and the relative ROCD of 3000 feet/min	35

LIST OF FIGURES

5.12	RA sense selection visualisation for the relative ROCD of 3000 feet/min and ownship's ROCD of 4300	35
5.13	Diagram of the RA logic composition	36
6.1	Illustration of the simulation parameters	39
6.2	Encounter simulation of single-threat encounter – Scenario 1	42
6.3	Encounter simulation of single-threat encounter – Scenario 2	42
6.4	Encounter simulation of single-threat encounter – Scenario 3	43
6.5	Encounter simulation of single-threat encounter – Scenario 4	43
6.6	Trajectory simulation - intruder accelerates to 2000 feet/min 10 seconds prior to the CPA	44
6.7	Trajectory simulation - intruder accelerates to 4000 feet/min 10 seconds prior to the CPA	44
6.8	Multiple-threat encounters - the CPA delay impact	46
6.9	Trajectory simulation - multiple-threat encounter with an RA sense reversal case	47
6.10	Multiple-threat encounter trajectory simulation - Scenario 1	48
6.11	Multiple-threat encounter trajectory simulation - Scenario 2	49
6.12	Multiple-threat encounter trajectory simulation - Scenario 3	49
7.1	AgentFly simulation visualisation	50
7.2	TCAS2 module structure diagram	52
7.3	The resulting vertical separation at the CPA for different TAS values	53
7.4	The impact of the α parameter on the reaction time for a high closure rate	54
7.5	The impact of the α parameter on the reaction time for a low closure rate	55
7.6	A rising ROCD impacting the VMD	56
7.7	The impact of the initial pilot response delay on the resulting VMD	57
7.8	Coordinated version of the TAS iteration	57
7.9	Coordinated version of the initial pilot response delay iteration	58
7.10	Multiple-threat encounter - Scenario 1	59
7.11	Multiple-threat encounter - Scenario 2	60
7.12	Multiple-threat encounter - Scenario 2 - coordinated version	61
7.13	Multiple-threat encounter - Scenario 3	61

Chapter 1

Introduction

The topic of this bachelor's thesis is the analysis of the airborne collision avoidance system called Traffic Collision Avoidance System (TCAS). In the following paragraphs, we will briefly summarise the background of the development of TCAS, its value for today's general air traffic and its potential for the development of future systems.

Since the last century, the main system for organising air traffic and preventing collisions between aircraft in controlled airspace has been Air Traffic Control (ATC). Air traffic controllers stationed at control towers plan flight paths for aircraft in their sector of controlled airspace to ensure air traffic separation. However, with the rise of air traffic, there have been accidents where ATC failed to prevent the loss of separation between aircraft. In 1956 the ATC system did not manage to ensure the separation between two airliners over the Grand Canyon resulting in a collision. This disaster encouraged the airlines and aviation authorities to begin developing an effective collision avoidance system. Such a system should act as the last resort, preventing collisions when separation services provided by ATC fail [23]. Since then, many collision avoidance systems have been designed. Currently, the only implementation of the International Civil Aviation Organization's (ICAO) standard for an Airborne Collision Avoidance System (ACAS II) is TCAS II version 7.1. This version of TCAS is currently used worldwide by most large commercial aircraft. Eurocontrol assessed the safety benefits of TCAS for Europe and found that it reduces the risk of mid-air collision approximately five times [7].

TCAS is an onboard system which collects information about nearby airborne traffic and uses it to detect the loss of separation which can occur due to a failure in the ATC system, for example. When it detects any danger of collision, it issues alerts to the pilot and advises them on how to react to the situation.

1.1 Motivation and Goals

We are interested in using a parametrised encounter simulation to find specific boundaries where the TCAS logic starts losing the ability to ensure separation. Increasing air traffic density causes new types of encounters which cannot be reflected by analyses using encounter modelling based on the recorded encounters from the radar sites. For example, multiple-threat encounters are already not as rare as was originally expected [13].

There has been an increase in development of unmanned aerial vehicles (UAVs) since the beginning of the 21st century, which was supported by many factors, like the extreme increase

in navigation accuracy thanks to the Global Positioning System or faster microprocessors [5]. This naturally motivated many analyses on the subject of using the knowledge gained from the many years of development and tuning of TCAS to modify it for the use of UAVs. We are interested if the collision avoidance system based on the TCAS logic combined with an autonomous model of the pilot response could be effective.

This thesis aims to:

- Analyse the collision avoidance logic of TCAS.
- Implement the TCAS functionality and verify the implementation.
- Integrate the collision avoidance logic implementation into a system of air traffic simulation.
- Design a model of the pilot response which parametrises various delays.
- Assess the collision avoidance system's functionality using various encounter scenarios.

1.2 Structure

The structure of this thesis is as follows. Chapter 2 describes the surveillance systems that are used to share information between aircraft and ground stations, focusing on transponders, which are crucial for providing data to the collision avoidance system's logic. That is followed by Chapter 3 which describes TCAS itself, mainly focusing on explaining the principles of the collision detection and resolution logic. Chapter 4 describes the state of the art providing insight on the methodology of collision avoidance systems' safety analysis. It also declares the methods that are used in this thesis to analyse TCAS. Chapter 5 introduces our implementation of the collision avoidance logic and shows methods used to verify the functionality of the subsystems within the collision avoidance system. Chapter 6 introduces the encounter parametrisation. Then, it is used in discrete encounter simulation using simple aircraft dynamics modelling. Various scenarios are simulated in order to verify the collision avoidance logic. Chapter 7 describes the integration of the collision avoidance system and pilot response model within the precise air traffic simulation, and then uses the simulation to analyse and verify the collision avoidance system.

The abbreviations used throughout this thesis are listed in Table 2 at the end of the document.

Chapter 2

Air Traffic Surveillance

TCAS utilises a mode S transponder that performs surveillance of nearby aircraft to provide information such as the relative position, bearing or altitude of these aircraft. This data is then used as an input for the collision avoidance system. It is collected independently of ATC using various modes of onboard transponders that the aircraft are equipped with.

The transponder controlled by TCAS operates by transmitting interrogations at 1030 MHz which are received by the nearby aircraft's transponders which then replies with a response at 1090 MHz that contains information dependent on the capabilities of the responding transponder's mode [23]. The transponder mode of the aircraft which is a threat to the TCAS-equipped aircraft (they shall be further referred to as "threat" or "intruder") directly corresponds to the level of services TCAS is able to provide for dealing with that particular aircraft, because transponders differ in what information they are able to provide, when they respond to an interrogation.

2.1 Transponder Interrogation Modes

Generally, TCAS is not able to provide protection against aircraft without an operating transponder, but in controlled airspace, transponders are considered mandatory equipment for general air traffic. For example, since 2011 the European Commission requires operating transponders of at least Mode S level for general air traffic [6].

2.1.1 Mode A/C without Altitude Reporting

The simplest transponder mode with which TCAS is able to cooperate is Mode A/C without altitude reporting. When interrogated, the transponder replies with a "squawk code", which is a 12 bit-long code that should serve as a unique identification of the aircraft.

2.1.2 Mode C

Mode C expands on Mode A by adding information about barometric altitude in the reply to an interrogation. The altitude resolution in this case is 100 feet expressed as the standard pressure altitude called flight levels (FLs). Different FLs correspond to hundreds of

feet, e.g., FL 250 means a pressure altitude of 25 000 feet. The identification code is still just 12 bits long allowing 4096 unique codes, which is not enough for today's traffic.

2.1.3 Mode S

Mode S is compatible with both previously mentioned modes, and it provides the barometric altitude as Mode C does. Additionally, short messages called squitters are used to carry various pieces of information between Mode S transponders. Mainly altitude with a 25 feet resolution, ICAO address or flight status. Mode S transponders replaced the squawk code with a 24 bit-long permanent ICAO address which serves as a globally unique identification code. The ICAO address is registered to an aircraft, and it does not normally change. Enhanced versions of Mode S (EHS) are capable of transmitting extended squitters containing advanced information like ground speed, roll angle or rate of climb/descend, which are very valuable for TCAS as they provide improved awareness of the situation [9].

2.1.4 Automatic Dependent Surveillance-Broadcast (ADS-B)

ADS-B is a surveillance technology which helps air traffic participators share information about their position, velocity etc. This system relies on Mode S transponders to transmit data collected by individual aircraft using the Global Navigation Satellite System (GNSS). For an illustration of ADS-B communication see Figure 2.1.

Its functionality is split into two parts called 'ADS-B out' and 'ADS-B in'. Aircraft with active ADS-B out broadcast extended squitters filled with data collected from GNSS. The frequency of position and velocity updates is 0.5 seconds [4]. The accuracy is much better than with data collected from radar-based systems and onboard devices, for example, it provides geometric height with a resolution of 6.25 feet [20]. The data transmitted by ADS-B out is collected by aircraft with operating ADS-B in and can even be rebroadcasted further (ADS-R function).

Aircraft may have ADS-B out without having ADS-B in but not vice versa as without the ADS-B out function ground bases and other aircraft would not register the aircraft, and therefore would not respond with information for the aircraft's ADS-B in.

ADS-B out is not received and processed just by aircraft but by ground stations too. These ground stations then share the information with ATC and other ground stations. Ground stations also collect information from primary surveillance radar and other systems.

With all this data the ground stations are able to collect, they play an important part in the whole ADS-B system by providing a service called Traffic Information Service - Broadcast (TIS-B). When a ground station taking part in the TIS-B system receives ADS-B out from an aircraft in range (usually 55 NM), it selects data about the traffic surrounding this particular aircraft from all the data it collected using various systems. It then transmits this customized package of information to its location. The dimensions and the shape of the area around the target aircraft that are covered by TIS-B are illustrated in Figure 2.2.

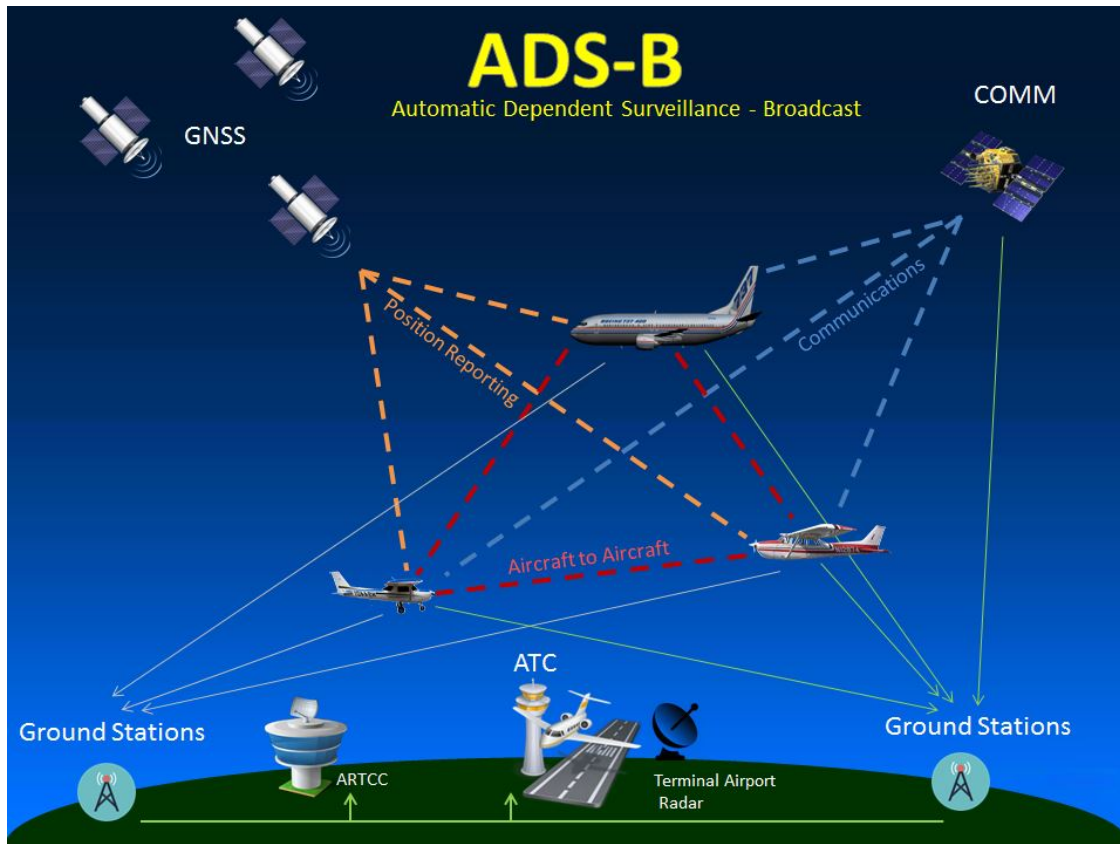

Figure 2.1: ADS-B communication illustration (borrowed from [16])

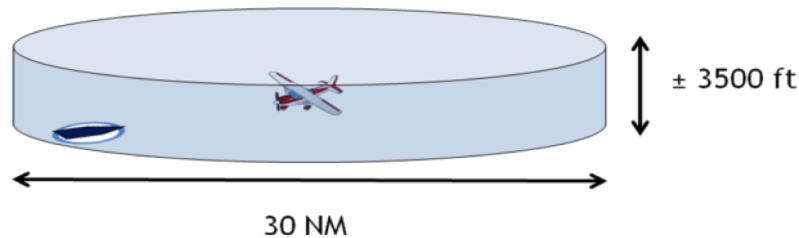

Figure 2.2: Area coverage of a TIS-B service around target aircraft (borrowed from [1])

2.1.5 TCAS Interaction with Transponders

When confronted with threats equipped with a transponder without altitude reporting, TCAS is able to warn the pilot about potentially dangerous traffic nearby (so-called traffic advisory, TA) [22]. Because the altitude is not provided by this type of transponder, TCAS is forced to expect the worst possible scenario, and it is likely to issue unnecessary alerts while an aircraft with such a transponder is passing way below or above its own aircraft. TCAS is not able to calculate and advise the best manoeuvre to avoid collision (so-called resolution advisory, RA), because it lacks the data needed to do so. Both TA and RA services will be described in greater detail later in Chapter 3 focusing on TCAS itself.

While dealing with a threat equipped with a Mode C transponder, TCAS II visualises the approximate relative position of the threat on a display and is able to provide both traffic and resolution advisory. For an illustration of the TCAS display's visualisation of threats see Figure 3.1. TCAS interrogates the Mode C aircraft once per second to get a position update.

When TCAS II encounters a Mode S intruder both TA and RA are provided to the pilot. The update frequency differs depending on the distance and closure rate of the threat, once per 5 seconds for distant threats and once per second for closer ones. If available, more detailed and accurate data is transmitted using extended squitters.

The ADS-B system definitely enlarges TCAS's potential as it provides it with very frequent and accurate data updates on surrounding traffic, which enables the collision avoidance system to deal with threats in the most effective way. Through TIS-B, TCAS is able to obtain data about the position of even unequipped aircraft. It is expected that in the future, ACAS X, the system which could replace TCAS II one day, will be focused on making extensive use of ADS-B and satellite-based navigation. The high update rate and data accuracy should also make it possible to design a collision avoidance system solely for the needs of unmanned aircraft (ACAS Xu) [17].

Chapter 3

TCAS Description

TCAS is a collision avoidance system that was designed to reduce the risk of mid-air collisions. It has been designed as an implementation of the ICAO ACAS II standard. ICAO states that the only applicable commercial implementation of the ACAS II standard is TCAS II and since January 2017 at least version 7.1 is required.[21]

TCAS acts as the last resort system to avoid collisions in the case of loss of separation due to a failure of the ATC system. It tracks trajectories of possible threats and helps the pilot avoid them using TAs and RAs. We will briefly describe how TCAS logic works in the means of detection of threats, issuing advisories and choosing the right vertical manoeuvre. For more information about the overall system functionality, see document [23]. A detailed description of the advisory algorithms can be found in document [15].

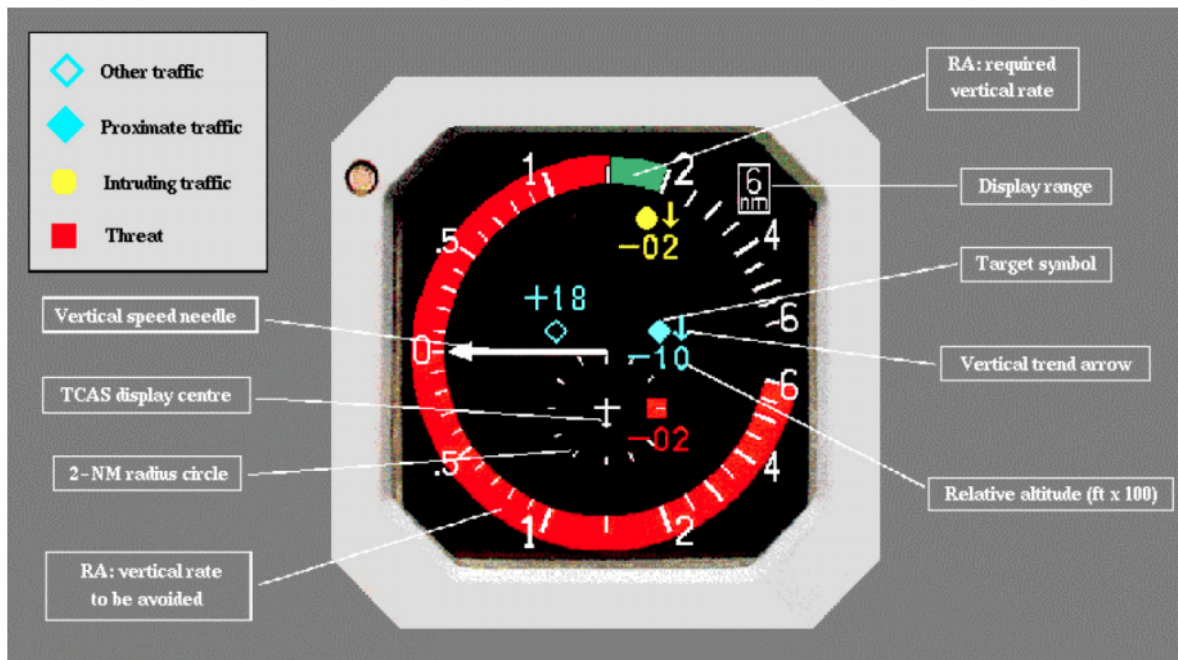
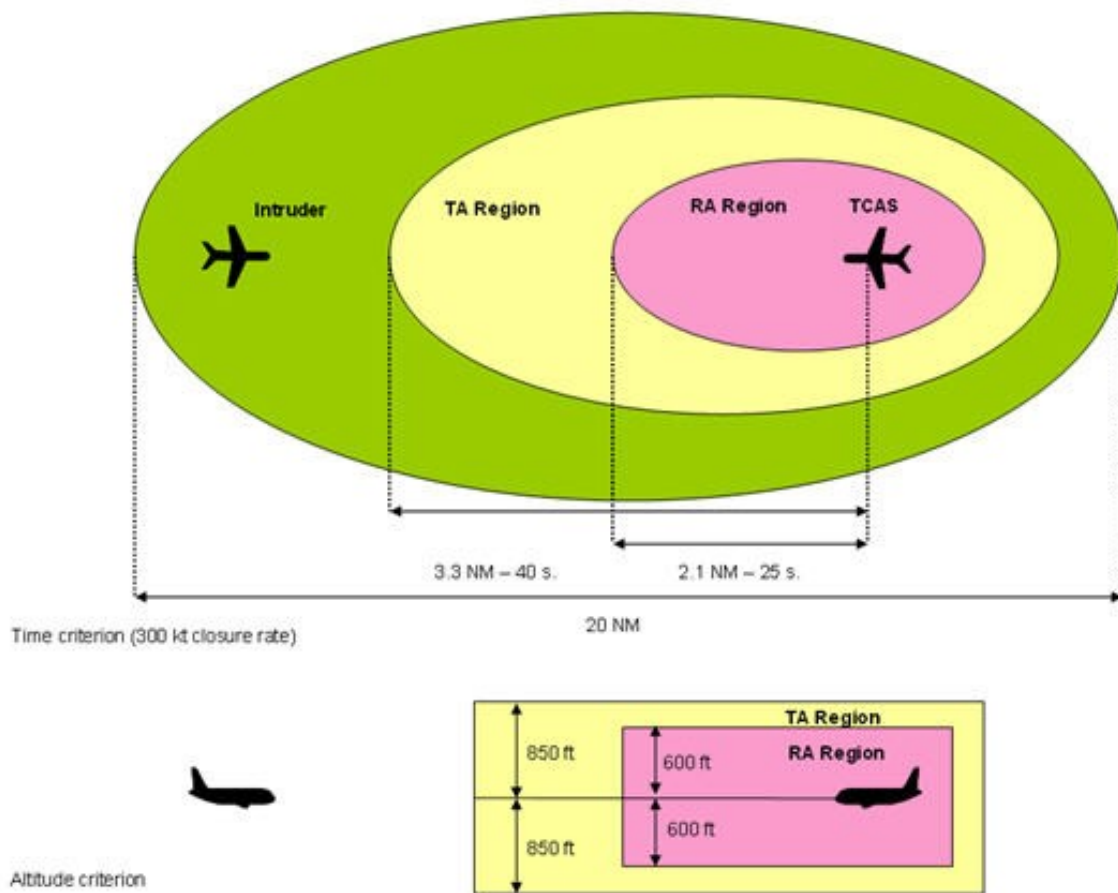

Figure 3.1: Illustration of the TCAS display of advisories (borrowed from [5])

3.1 Threat Detection

3.1.1 Advisories Concept

TCAS tracks the position and velocity of nearby aircraft and detects if any of them entered the protected volume of airspace around the ownship. Ownship is a term used to refer to the TCAS-equipped aircraft from whose point of view we describe the collision avoidance logic. Similarly, the other aircraft in the described encounters are referred to as threats or intruders.



Example of ACAS Protection Volume between 5000 and 10000 feet

Figure 3.2: Illustration of threat detection volume around the ownship (borrowed from [10])

When a threat is approaching, TCAS issues a TA, which should raise the pilot's awareness of the threat and help them track the threat's movement. It does so by visualising the threat's approach on a display. Later, if the intruder moves even closer to the ownship, an RA is issued, which recommends the best vertical manoeuvre to the pilot in order to maintain the minimum allowed vertical separation (Altitude LIMit abbreviated as ALIM) at the hor-

horizontal Closest Point of Approach (CPA). For an illustration of the TCAS display advisory visualisation see Figure 3.1. The shape of the area and the composition of advisory regions where nearby aircraft are detected as threats is illustrated in Figure 3.2.

An RA is often in contradiction to ATC instructions and pilots should always comply with TCAS, returning to the previous ATC clearance only after TCAS announces "clear of conflict" [11].

3.1.2 Issuance Conditions

Everytime TCAS receives a new position update on nearby aircraft, it inspects the data to test if an advisory should be issued. From the data, TCAS derives relative distance, closure rate, time to CPA and time to the moment when both aircraft reach the same altitude (so-called time to co-altitude). Simply put, the detection logic works by testing if any nearby aircraft are close enough (relative horizontal/vertical distance lower than the $DMOD^1/ZTHR^2$ threshold) or approaching fast enough (time to CPA/time to co-altitude lower than the TAU^3 threshold) in both the horizontal and the vertical sense at once. For an illustration of the thresholds that form the advisory region see Figure 3.3. To filter out unnecessary advisories a conflict detection 2-D algorithm (CD2D)[15] is used as it confirms if the horizontal separation limit will be broken in the currently predicted flight path.

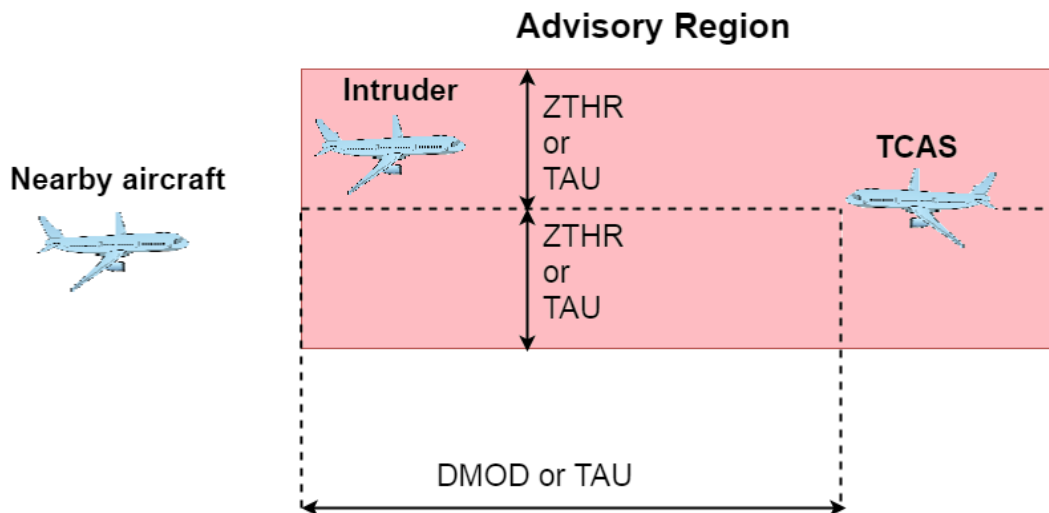

Figure 3.3: Illustration of thresholds forming the advisory detection area — the TAU threshold is compared with the time to CPA approximation (τ_{mod}) and with the time to co-altitude, DMOD and ZTHR thresholds are compared with horizontal and vertical distance, respectively. Aircraft within the area violate the separation and are considered to be intruders

¹Distance MODified - horizontal distance threshold

²vertical distance (Z axis) THReshold

³time threshold used in both horizontal and vertical case

The simple concept of collision avoidance logic is enhanced significantly by usage of the modified tau (τ_{mod}) concept [14] which is used by TCAS. Instead of calculating the time to CPA by simply dividing the relative horizontal distance by closure rate, it uses the following formula

$$\tau_{mod}(\vec{d}, \vec{v}) \equiv -\frac{\|\vec{d}\|^2 - DMOD^2}{\vec{d} \cdot \vec{v}}, \quad (3.1)$$

where \vec{d}, \vec{v} are vectors of relative horizontal distance and velocity.

The main reason τ_{mod} was introduced is because of the problem with slow closure rate intruders [23]. The illustration of the trajectories where usage of the τ_{mod} concept improves the collision avoidance logic is depicted in Figure 3.4. If an intruder and the ownship have low relative horizontal velocity, the calculated time to CPA will be very high even at close distances. Because of that, the time to CPA will not decrease under the TAU value, and an advisory will not be issued. Intruders like these would get very close to the ownship without raising alerts until they passed the DMOD horizontal distance boundary. This causes potential danger, since the unaware ownship/intruder may start decelerating/accelerating resulting in a potential collision within the next few seconds. In that case, an advisory would be issued, but there would be no guarantee of the pilot having enough time to react to the RA.

The advantage gained by introducing τ_{mod} is that the logic now focuses more on having enough time to react before an intruder even passes the DMOD boundary. The collision

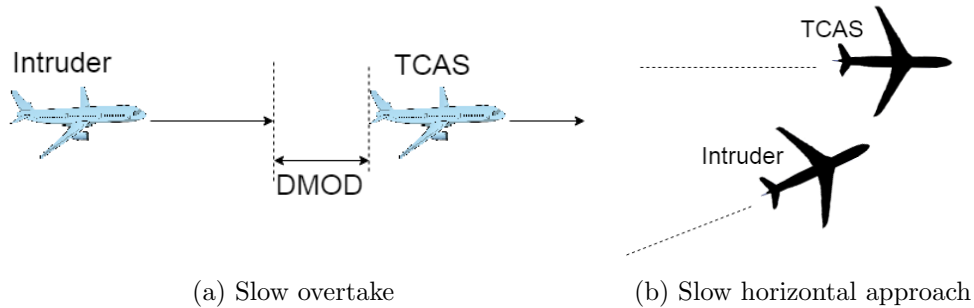

Figure 3.4: Illustration of trajectories in which the τ_{mod} concept is needed

avoidance logic then does not rely on protecting just one point in space, where the ownship is expected to be, but rather a small area defined by the DMOD and ALIM thresholds (the ALIM threshold is illustrated in Figure 3.5, its function is described further in this chapter). τ_{mod} is always higher than the time to the CPA. For higher closure rates the τ_{mod} will work almost the same as the time to CPA because DMOD is a very small distance compared to common horizontal ranges and closure rates. In the low closure rates case using τ_{mod} instead of the time to CPA is likely to gain a few seconds for the pilot's reaction.

3.1.3 Threshold Parameters

The shape and size of the protected volume is defined by the relative velocity of the aircraft and also by the thresholds TAU, DMOD and ZTHR. TAU defines how many seconds

before reaching the CPA or co-altitude TCAS should issue a specific advisory. DMOD similarly defines what the relative horizontal distance in which an advisory should be issued is, and ZTHR acts as a vertical distance boundary for the same purpose. The last threshold important for the TCAS threat detection logic is ALIM, a minimum vertical separation at the CPA that the collision avoidance logic is aiming to provide with manoeuvres recommended by an RA.

The value of these threshold parameters is dependent on the current sensitivity level. The reason to establish sensitivity levels is to provide a customized amount of protection corresponding to the current situation. An effective collision avoidance system must maintain the level of protection without issuing too many unnecessary advisories which could cause large deviations from ATC routes. Sensitivity levels help react to threats in an optimal way [23]. The sensitivity level corresponds to the current ownship's altitude. With higher altitude comes a higher sensitivity level causing an increase in size of the protected volume surrounding the ownship.

Table 3.1: Threshold values for different sensitivity levels [23]

Zone	Current Altitude (feet)	Sensitivity Level	TAU (sec)		DMOD (NM)		ZTHR (feet)		ALIM (feet)
			TA	RA	TA	RA	TA	RA	RA
1	0 - 1000	2	20	NaN	0.30	NaN	850	NaN	NaN
2	1000 - 2350	3	25	15	0.33	0.20	850	600	300
3	2350 - 5000	4	30	20	0.48	0.35	850	600	300
4	5000 - 10000	5	40	25	0.75	0.55	850	600	350
5	10000 - 20000	6	45	30	1.00	0.80	850	600	400
6	20000 - 42000	7	48	35	1.30	1.10	850	700	600
7	42000 - ∞	7	48	35	1.30	1.10	1200	800	700

In Table 3.1 the values of the thresholds are shown. From the values, we can see that at altitudes lower than 1000 feet TCAS RAs are inhibited. That is because of the close vicinity aircraft have to be in, while taking off or landing. We can also see that TCAS advisories are configured to be issued just tens of seconds before a potential collision.

3.2 Conflict Resolution

When a threat is detected and an RA is issued, TCAS has to choose the correct way to address the situation. Since the current versions of TCAS are only capable of advising vertical manoeuvres, the strategy is to extrapolate horizontal trajectories and choose a manoeuvre that would ensure that at the time when aircraft are closest horizontally, the minimum ALIM vertical separation will be maintained to avoid a collision. The TCAS logic uses a linear extrapolation of the intruder's trajectories based on their current velocity as it has no way of knowing the other pilot's intentions. When extrapolating the trajectory of its own aircraft, parabolic extrapolation is used. It is based on the assumption that the pilot will initially respond with a 0.25 g (gravitational acceleration) acceleration manoeuvre [19]. For the possible

consequent ROCD increases and RA reversals, 0.35 g acceleration is assumed to be used [19].

Naturally, during the selection of a correct advisory, the biggest priority is preventing a collision which is realised by ensuring the ALIM separation. In the rare cases where at least the ALIM amount of vertical separation cannot be provided, the corrective RA providing the largest possible vertical separation is issued. A major factor is keeping deviation from the current flight path as small as possible and also reducing the amount of deviations [23]. In dense terminal areas, a high amount of unnecessary alarms might render the system inapplicable because unnecessary manoeuvres might be causing new alerts.

3.2.1 RA Type Selection

There are two types of resolution advisories, preventive and corrective. Preventive advisories do not require the pilot to manoeuvre, they only warn the pilots about manoeuvres that should not be executed. A good example might be a threat that is a few flight levels above the ownship maintaining the current vertical separation. Such intruders might pass through the ZTHR zone and raise alerts, but since they are not getting any closer vertically, there is no imminent danger of them passing through the critical ALIM zone, meaning no manoeuvre is needed. The described example is illustrated in Figure 3.5

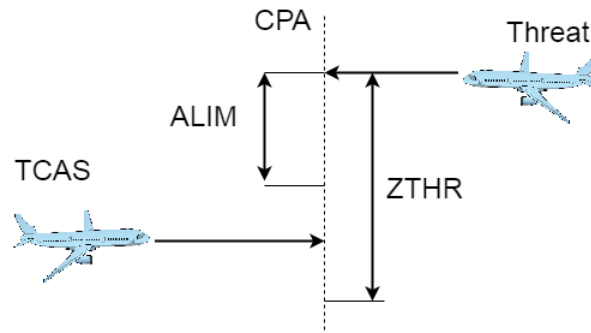

Figure 3.5: Preventive RA example situation

In this case, TCAS would issue a preventive RA restricting the pilot from climbing. These advisories are a good way of preventing the pilot from starting a manoeuvre which might be difficult to reverse by a corrective RA quickly enough to avoid a collision. To decide whether the RA is corrective or not, TCAS calculates the vertical separation at the CPA and compares it with the current ALIM. If the expected vertical separation is lower than ALIM, a corrective advisory is issued.

3.2.2 RA Sense Selection

After the corrective advisory is issued, TCAS chooses the direction of the manoeuvre. It does so by extrapolating the trajectories for both the downward and the upward RA sense and by calculating the vertical separation at the CPA for both. If both of them are expected to provide at least the ALIM separation, then the non-altitude crossing RA sense is selected.

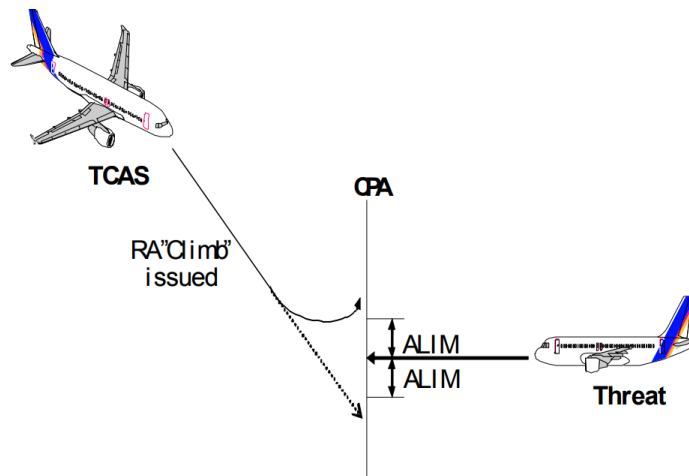

Figure 3.6: Selection of non-crossing RA sense (borrowed from [23])

That means that if the initial ownship's altitude is higher than the threat's altitude, a climb is preferred even when the descend provides a larger vertical separation as shown in Figure 3.6. If only one of the RA senses provides the ALIM separation, then it is preferred. Finally, if neither of the senses is able to provide the ALIM separation, the one with the larger vertical separation at the CPA is preferred.

TCAS expects the pilot to react to an initial RA within approximately 5 seconds. The reaction delay to subsequent RAs is expected to be lower, about 2.5 seconds [23]. As the encounter continues, TCAS keeps getting new position updates, and if the situation does not go according to predictions, TCAS issues subsequent RAs to adjust the manoeuvre. For example, after the intruder has changed his rate of climb/descend, TCAS might issue an increase/decrease of the vertical rate to maintain the ALIM separation. If the current RA sense is not able to provide ALIM anymore, a reversal RA might be issued, advising the pilot to change the climb to descend or vice versa as illustrated in Figure 3.7.

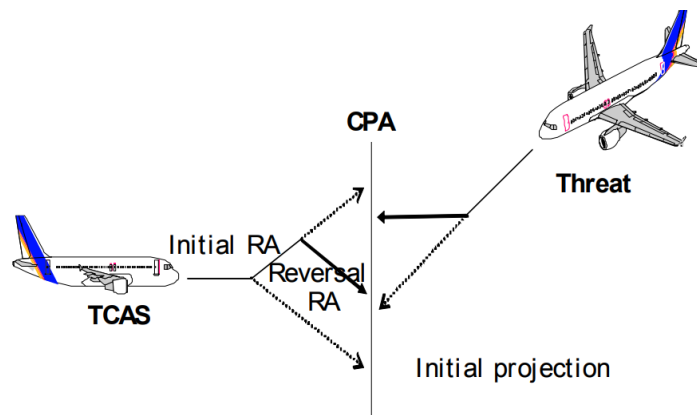

Figure 3.7: Reversal RA invoked by the threat's change in the rate of descend (borrowed from [23])

If TCAS notices that an unnecessary amount of separation was gained by the manoeuvre, it is designed to weaken the initial manoeuvre to prevent a bigger deviation from the original flight path than needed.

For an illustration, the different types of RA for the downward sense are listed in Table 3.2 with their corresponding aural alerts. The RAs for the upward sense use the same vertical rate ranges, the only difference is that they are positive. As shown in Table 3.2 the ROCD range is from -4400 to 4400 feet/min. TCAS assumes that the aircraft is capable of reaching ROCDs within this range.

Table 3.2: RA categories (borrowed from [21])

Downward sense		
RA	Required vertical rate (ft/min)	Aural
Descend	- 1500	Descend, descend
Crossing Descend	- 1500	Descend, crossing descend; Descend, crossing descend
Maintain Descend	- 1500 to - 4400	Maintain vertical speed, maintain
Maintain Crossing Descend	- 1500 to - 4400	Maintain vertical speed, crossing maintain
Level Off ¹	0	Level off, level off
Reversal Descent ²	- 1500	Descend, descend NOW; Descend, descend NOW
Increase Descent ²	- 2500	Increase descent, increase descent
Preventive RA	No change	Monitor vertical speed
RA Removed	—	Clear of conflict

¹ New RA in version 7.1, replacing "Adjust vertical speed, adjust" from version 7.0

² Not possible as an initial RA

3.2.3 Multiple-threat Encounters

When dealing with multiple intruders at once, TCAS uses a similar logic as in a single-threat encounter. It calculates the separate CPAs of all intruders and then it prioritises the manoeuvre that will keep at least the ALIM separation from all threats at the corresponding CPAs. In those encounters, it is not that unlikely to just choose a manoeuvre providing the biggest separation possible, because ALIM cannot be reached with all intruders. It is also possible to use a composition of RAs. For example, the aircraft might be avoiding a threat from below by climbing 1000 feet/min, but at the same time be restricted from vertical rates over 2000 feet/min, because another threat is above. An illustration of the situation can be seen in Figure 3.8.

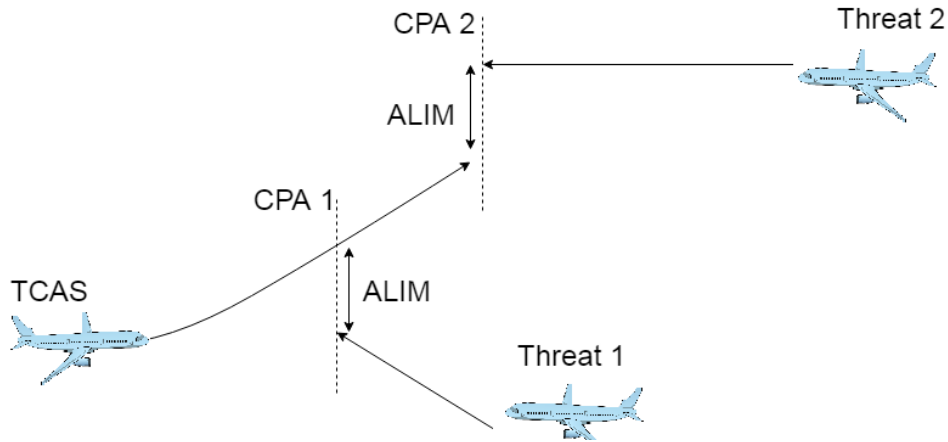

Figure 3.8: Multiple-threat encounter illustration

3.3 Coordinated Encounters

The TCAS-equipped aircraft's transponder periodically broadcasts identification and information on whether TCAS is operational or not. Thanks to that, TCAS is aware which of the nearby aircraft are equipped and capable of coordination. When two aircraft equipped with TCAS are in a risk of collision, they communicate in order to choose complementary RA senses.

Usually, one of the aircraft's TCAS issues an RA earlier, and then it selects an RA sense as it would normally do. Then, using a Mode-S transponder, it sends the intent to the second aircraft. When the second aircraft issues an RA, it will use the stored intent from the first aircraft to choose a complementary RA sense. An option of a one-time RA reversal was added to coordinated encounters in newer versions of TCAS II for the cases where one of the pilots does not comply with the TCAS instructions.

In the case where both aircraft would select a non-complementary RA sense at once and send it to each other, the aircraft with a lesser ICAO identification code has priority in choosing the sense, and the aircraft with a bigger ICAO address will reverse their RA according to the intent received [23]. The full coordination process is illustrated in Figure 3.9.

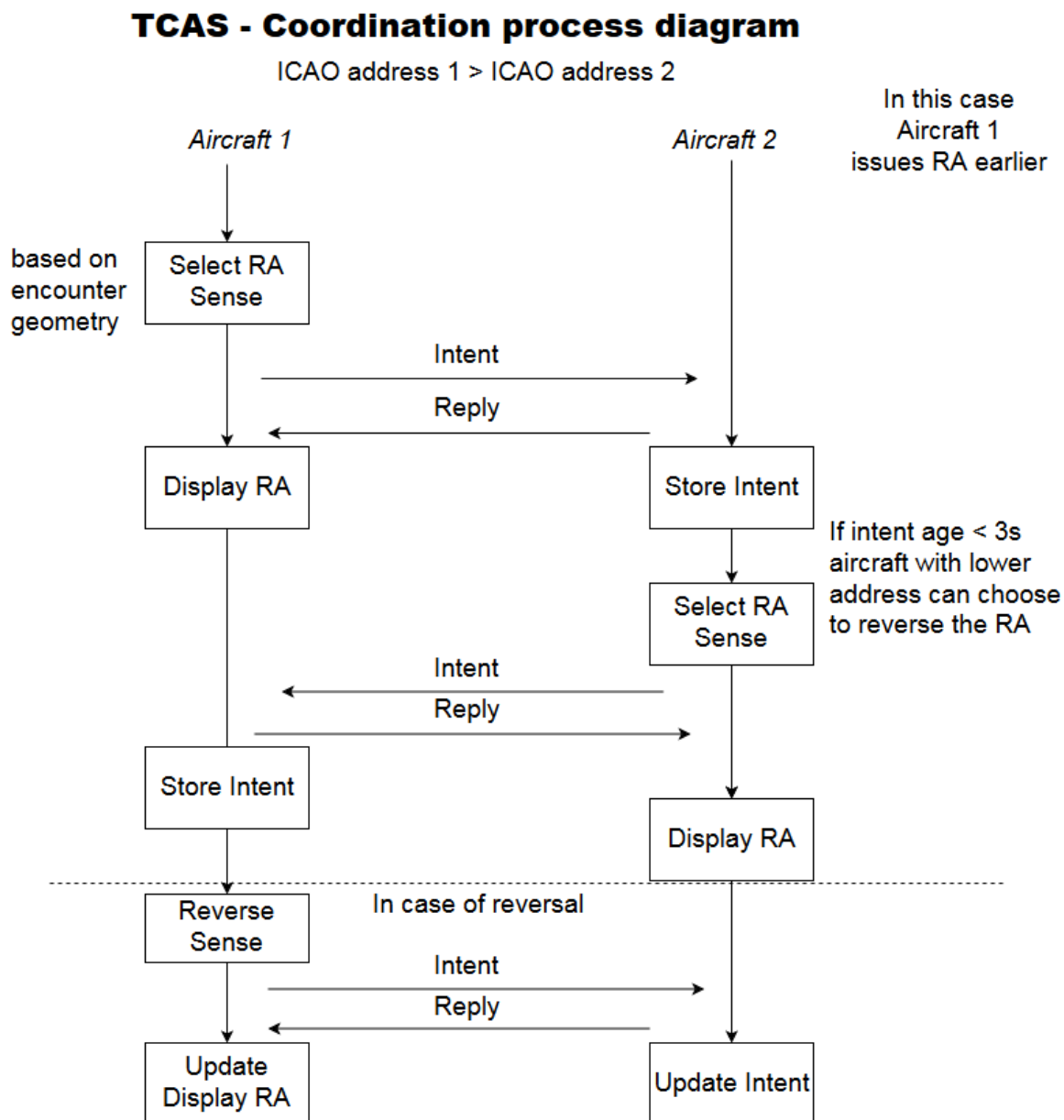

Figure 3.9: Diagram of coordination process between two TCAS-equipped aircraft

Chapter 4

TCAS Analysis Methodology

In this chapter, we describe the methodology of the TCAS functionality verification within the air traffic simulator, and we further assess its potential for UAVs. Finally, the methods used for analysis of TCAS functionality are presented.

There has been discussion over how to use TCAS on UAVs. It had been considered to only use TCAS in traffic advisory mode which would notify the remote pilot on the ground to take control in the case of collision danger. For fully autonomous collision avoidance, TCAS could always take control of the UAV in case of conflict and fly it according to the resolution advisories until the end of the conflict. If all the data were correct and accurate, this option would greatly benefit from the almost immediate response the processor is able to provide, since in the case when a human pilot flies according to RAs, there are long delays of up to several seconds every time a new RA is issued [5].

4.1 Verification Techniques Overview

The analysis of collision avoidance systems historically uses three main techniques, which thoroughly verify its functionality from different points of view. These methods are: (i) fault tree static analysis, (ii) dynamic simulation and (iii) performance analysis using actual flight testing [5]. The focus of this thesis is on the method of computational dynamic simulation, but first, we shall briefly explain fault tree analysis and the flight testing methods.

Fault tree analysis is a top-down method in which we define the undesirable state, and then we recursively search for a combination or a series of lower-level events that can lead to such a state. In the end, this approach yields a good apprehension of what the potential scenarios in which the system failure could occur are. For the analysis of the collision avoidance system, the undesirable state is defined as a collision or a loss of certain limits of separation.

Flight testing is used to confirm that the computational simulation of the encounters actually resembles real encounter trajectories and behaviour of the collision avoidance logic. Usually, a set of encounters covering the unique situations is specified, performed and compared with the prior simulated encounter trajectories.

4.2 Computational Simulation Analysis

The method of dynamic simulation needs a collision avoidance logic model, a parametrised encounter model, an aircraft dynamics model, a pilot response model and a suitable computa-

tional air traffic model. These models are then used to simulate aircraft encounters, capturing features of TCAS performance. The results of the simulation are then processed statistically to find potential causes of system failures. For that, we also need to specify the defining parameters of the encounters forming encounter models.

4.2.1 Collision Avoidance Logic Model

We aim to implement a fully autonomous model of collision avoidance logic. In the case of a conflict, the parametrised model of the pilot would fly according to the instructions based on the RAs. These RAs would be issued by the implementation of the TCAS logic. The pilot model should include parameters defining the way the pilot responds to the RAs. This way, we can simulate the same encounter scenarios for different pilot response delays to see how TCAS functionality would change if an autopilot with much faster reactions than a human pilot responds to RAs.

In Chapter 5, we describe how we proceeded to implement and verify the TCAS collision avoidance logic required for our simulation.

4.2.2 TCAS Functionality Metrics

The most commonly used metric to statistically describe the functionality of the collision avoidance system is called the "risk ratio". The risk ratio is defined as follows:

$$\text{Risk Ratio} \equiv \frac{\text{the probability of a near mid-air collision with operational TCAS}}{\text{the probability of a near mid-air collision without TCAS interventions}} \quad (4.1)$$

A near mid-air collision (NMAC) is usually defined as a loss of a 100 feet separation in the vertical sense and a 500 feet separation in the horizontal sense simultaneously. The safety analysis of TCAS simulates generated or otherwise obtained encounter models and compares the number of NMACs when simulated with TCAS on and otherwise [12, 13].

Another useful metric introduced by Griffith in [13] is the change in vertical miss distance (VMD), where VMD is defined as the vertical separation at CPA. To obtain the metric, we must simulate the same scenario in two versions, one with operational TCAS and the second without. We record the VMDs in both scenarios and then calculate the metric by subtracting the second scenario VMD from the first scenario VMD. This metric directly pictures how TCAS impacts the vertical separation by issuing RAs. In our simulation in chapters 6-7, we mostly focus on encounters where the VMD is near zero in the version without operational TCAS. Then, the VMD in the encounter with active TCAS directly characterises the effectivity of the collision avoidance system.

4.2.3 Encounter Modelling

It is important for the dynamic simulation to somehow obtain a large amount of encounters that would accurately resemble real airborne encounters that TCAS is expected

to deal with effectively. Past analyses done by Lincoln Laboratory used aircraft encounter records collected from radar sites to obtain a probabilistic model of encounters, which would resemble the actual situations TCAS-equipped aircraft are likely to encounter in real airspace. Possible model variables are vertical rates, true airspeed or the altitude level of each aircraft in the encounter. Since there are simply not enough recorded NMACs or MACs for the purposes of the collision avoidance simulation, it is necessary to generate a larger amount of suitable encounters. The Monte Carlo technique can be used to produce initial conditions defining the encounters using the probabilistic model [12, 13, 5]. The Monte Carlo technique is a stochastic method which repeatedly samples variables taking their probability distribution into account. It is typically used to produce millions of encounters that are then used to verify the robustness of the collision avoidance system [12].

The problem with the lack of data needed to produce a fully specified probability model arises when modelling multiple-threat encounters. With the addition of each threat, the number of variables defining a single encounter rises. That causes the number of potential variable combinations to rise exponentially, creating the need for a huge amount of data to correctly assume the probability distributions of all parameters. There is also not as much data available about observed multiple-threat encounters as they are rarer than single-threat encounters. That renders the original approach incapable of creating a proper model. Griffith in [13] deals with this problem by creating multiple-threat encounters by starting with the single-threat encounter generation and then using a modified single encounter generation to add another threat correlated to the first aircraft.

The analyses done by Lincoln Laboratory focused on generating encounters based on the encounters recorded by radar sites [12, 13]. In this work, we choose a different perspective. As mentioned in the introduction, we are interested in using a general parametrised encounter simulation to find specific boundaries where TCAS logic starts losing the ability to ensure separation. Recorded encounters cannot reflect the increasing air traffic density which causes new types of encounters. For example, encounters involving more than one threat are already more common than it was originally expected [13].

Encounter simulation should include parameters defining initial rates of climb/descent (ROCD), true airspeeds (TAS), altitude levels of all participants, angles under which aircraft approach the CPA and the distance between the separate CPA in case of a multiple-threat encounter.

The encounter definition used in this thesis for simulation is introduced further in Chapter 6.1.

4.2.4 Aircraft Dynamics Models

In the Lincoln Laboratory's past analyses the aircraft motion was modelled using point-mass dynamics with 4 or 6 degrees of freedom taking into account acceleration constraints and response characteristics [12].

Instead of using the point-mass aircraft dynamics model, we use the Base of Aircraft Data (BADA) Aircraft Performance Model (APM) developed and maintained by EURO-

CONTROL [8]. BADA APM is designed to help researchers simulate and predict aircraft trajectories. BADA includes model specifications containing equations describing relations between aircraft performance parameters, and datasets containing a number of coefficients for each aircraft model necessary for calculations of performance parameters.

The main parts of the performance model are the atmosphere model and the Total-Energy Model (TEM). The atmosphere model defines how atmospheric properties like pressure, temperature and density can be expressed as functions of altitude. The atmospheric properties are essential for aircraft performance and movement calculations [18].

The TEM uses an equation to describe that the change in potential and kinetic energy is equal to the rate of work done by forces impacting the aircraft. For the exact equations see document [18].

The TEM equation has three input variables: true airspeed, ROCD and thrust. Two of these variables can be chosen, and the third is obtained using the BADA equations. TCAS II is a system relying solely on vertical manoeuvres, so we will need to control the ROCD variable. Since TCAS does not have any logic dealing with horizontal acceleration, we fix the true airspeed on the initial value defined by the encounter parameter. When using this aircraft dynamics model for a specific aircraft, a problem can arise: the thrust for given values of ROCD and TAS exceeds the maximum/minimum thrust of the aircraft. In this case, the aircraft cannot comply with the given ROCD and TAS. The highest/lowest possible ROCD is set instead.

The specific aircraft model is defined using eight parameter categories. These categories are:

- Aircraft type — contains parameters such as the number of engines, engine type, the wake category
- Mass — defines the minimum, maximum mass, and maximum payload mass
- Flight envelope — characterises the minimum speed, maximum speed, and maximum altitude of the aircraft
- Aerodynamics — includes parameters characterising the aerodynamic drag
- Engine thrust — contains coefficients needed for the calculation of the maximum climb, descent, cruise and take-off thrust levels
- Reduced power climb — allows the simulation of climbs using a reduced climb setting giving a realistic profile
- Fuel consumption — contains parameters describing the fuel flow for the climb, descend and cruise flight phases
- Ground movement — aircraft wingspan, aircraft length, take-off and landing length with specific conditions¹

¹”with maximum take-off/landing weight on a hard, dry level runway under International Standard Atmosphere conditions and no wind” [18]

In total, these categories contain 50 different coefficients which describe the specific aircraft model. In BADA version 3.8, there are over 300 available aircraft models [18].

4.2.5 Pilot Response Model

One of our goals is to use the parametrised pilot response model to inspect how delays in the response to the RA issuance affect the RA logic's capability of conflict resolution. For this purpose, we define the pilot response using the three following independent parameters:

- initial response delay rd_{init} ² [s]
- consequent response delay rd_{cons} ³ [s]
- RA response age ra_{age} [s]

rd_{init} defines how long it takes the pilot to take action after the first RA was issued. rd_{cons} defines how long after the previous action, the pilot is able to adjust the manoeuvre according to possible consequent RAs. When the pilot takes action according to an RA, he does it according to the most recent RA issued. This RA contains information that is at least as old as specified by the ra_{age} parameter. For example, for an rd_{init} of 5 seconds and an ra_{age} of 1 second, after the initial RA issuance it will take the pilot 5 seconds to take action, but during those 5 seconds there will be 5 new position updates⁴ which could possibly cause modifications to the original RA. The pilot model will react to the RA that is most recent out of the RAs that are at least 1 second old (the value of ra_{age}). The rd_{init} and rd_{cons} parameters aim to characterize the delay in the reaction of the pilot after the alerts are issued. The ra_{age} parameter reflects the small but inevitable computational delay and data transmission delay which make it impossible for the pilot to react to the actual most recent data update.

4.2.6 Air Traffic Model

Modelling of the air traffic is provided by the AgentFly simulation system and it is further described in Chapter 7 which focuses on integrating the collision avoidance logic and the pilot response model within the air traffic simulation system.

²the default value is 5 seconds as the TCAS logic assumes it takes 5 seconds for the pilot to react to an initial RA [23]

³the default value is 2.5 seconds as the TCAS logic assumes it takes 2.5 seconds for the pilot to react to the subsequent RAs [23]

⁴for the common Mode S transponders the data updates occur once per second as described in Chapter 2

Chapter 5

TCAS Mechanism Implementation

Our goal is to implement a collision avoidance logic model based on TCAS which in the case of loss of separation would advise a vertical manoeuvre in the form of an RA. These RAs would then be processed by the pilot response model. In the next paragraph, our approach to implementing and verifying the collision avoidance logic model is introduced.

First, we implemented the TCAS advisory detection logic. To verify the functionality of the implementation, we visualise the protected volume surrounding the ownship. For different input parameters, we confirmed that the plotted area corresponds with the TCAS logic definition. The next part of the TCAS logic that needs to be implemented is the RA type, sense and ROCD selection. Similarly to the previous case, we want to visualise the results of the logic for ranges of the input parameters and compare them with the TCAS logic definition. Using the advisory detection logic and RA type, sense and ROCD selection implementation, we have built a system responding to position updates with RAs in the case of loss of separation. We have verified this RA logic model in a simple simulation using a point mass model of aircraft dynamics to see if the issued RAs provide vertical separation corresponding to the current ALIM and particular situation (Chapter 6). Furthermore, the collision avoidance logic model was connected to the pilot model, and to a more precise aircraft dynamics model (described in Section 4.2.4) and was used in a parametrised simulation of encounters (Chapter 7).

5.1 Advisory Detection Logic

This section focuses on the implementation of the logic which decides whether an advisory should or should not be issued. After receiving a position update, TCAS separately tests each of the nearby aircraft for the issuance of an advisory. In Figure 5.1 a diagram of the advisory detection logic can be seen. The inputs are the single aircraft's position update, the ownship's position update and the advisory type. At first, the relative position and velocity are derived from the ownship's and the potential threat's position update. Depending on the ownship's altitude and the advisory type (TA/RA), a currently active set of thresholds is selected. Thresholds that are important for the advisory issuance test are DMOD, ZTHR and TAU.

Three different functions as introduced by Muñoz et al. in [15] are applied to the data:

1. Horizontal Check¹,

¹Referred to as *Horizontal_RA_i* in [15]

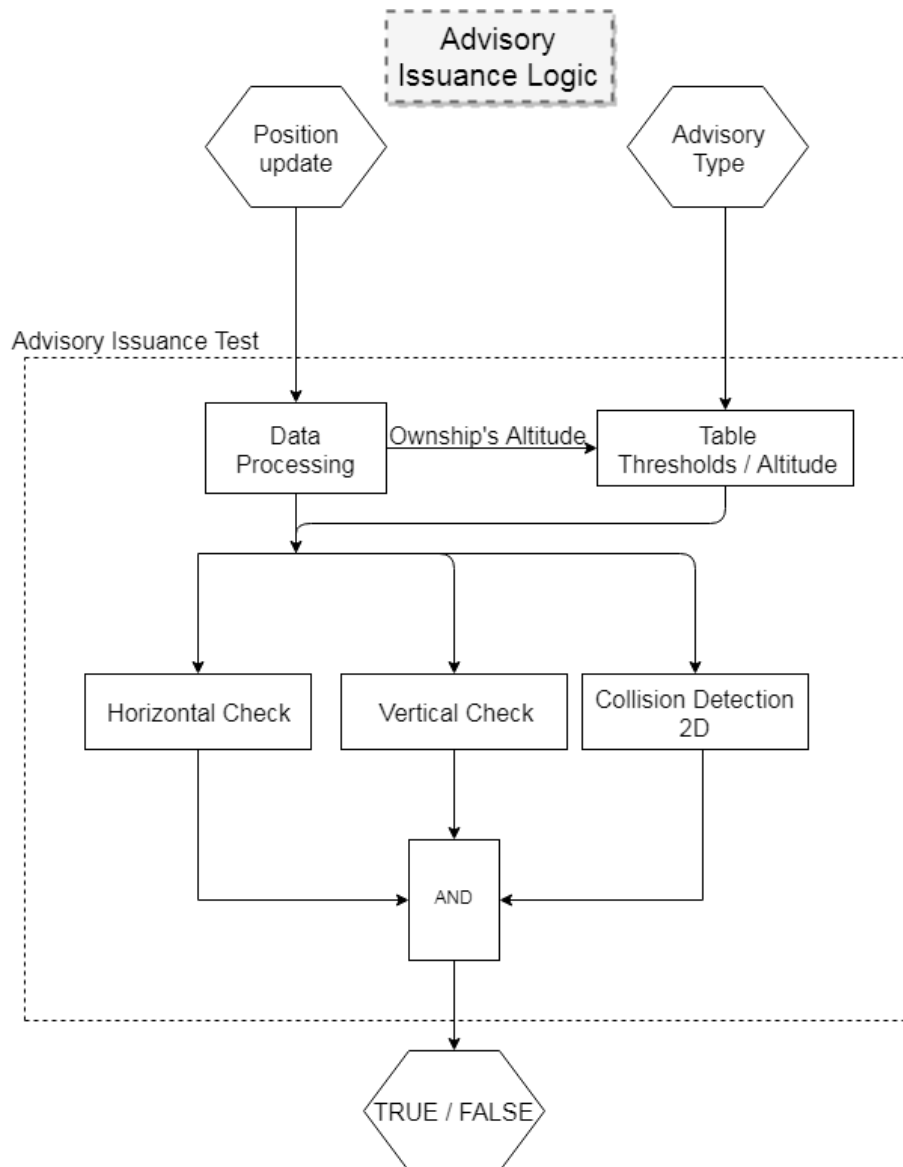

Figure 5.1: Advisory issuance logic diagram

2. Vertical Check²,
3. Collision Detection 2D algorithm

The arguments of the Horizontal Check function are the relative horizontal position, velocity and the thresholds DMOD and TAU. The Vertical Check function similarly takes relative altitude, vertical velocity and the ZTHR and TAU thresholds. The CD2D function's inputs are the relative horizontal position, velocity and the DMOD threshold. If all three functions decide that the tested aircraft is a threat, TCAS will address the situation by issuing a corresponding advisory.

²Referred to as *Vertical_RA_i* in [15]

5.1.1 Verification

For the sake of simplicity, the ownship's altitude is set to the same altitude of 1500 feet in all scenarios. According to Table 3.1 the altitude corresponds to the 3rd sensitivity level. Values of DMOD, ZTHR and TAU are 0.2 NM, 600 feet and 15 seconds, respectively. The ownship's horizontal position is set to the coordinates (0,0). The intruder's heading is in the direction of the X-axis and the ownship's heading is in the opposite direction³.

To verify the functionality of the RA detection logic, we use the following test scenarios:

Scenario 1 — An analysis of the simplest situation where the relative velocity vector is a zero vector. Since the intruder is not getting any closer in this scenario, an RA should be issued only if the intruder is within the protected volume defined only by the DMOD and ZTHR thresholds. The RA detection area is depicted in Figure 5.2.

Scenario 2 — The relative velocity is set to 120 knots which is a relatively small amount (approximately 60 m/s). The protected area around the ownship is captured in Figure 5.3.

Scenario 3 — The relative velocity is raised to 390 knots (approximately 200 m/s), and the relative ROCD is set to -3000 feet/min. The area where our implementation of the logic detected an RA is depicted in Figure 5.4.

Horizontal limits

In Figure 5.2a we can see a horizontal projection of the area where the logic calls for RA issuance in Scenario 1. The shape of the horizontal projection forms a full circle around the ownship's position (0,0) with a radius corresponding to DMOD (0.2NM). As expected in this simple case, the RA is issued only when the intruder is within the DMOD horizontal distance.

If we look at the horizontal projection in Figure 5.3a, we can see that compared to the shape of the original area from Scenario 1, it is stretched in the negative X-axis direction in this case. This is caused by the relative velocity vector pointing exactly in the opposite direction. We can see that the width of the area is limited by the DMOD distance. The data cursor in Figure 5.3b shows that the RA is issued up to a distance of 0.55 NM in the negative X-axis direction. This is 2.5 times more than the DMOD threshold. This distance should provide a bit more than the TAU amount of seconds before a critical loss of separation as explained in Section 3.1.2. If we divide the distance by the velocity to calculate the approximate time to the CPA, we obtain 16.5 seconds. That confirms that the RAs issued after an intruder enters the protected zone are providing at least the TAU amount of time before reaching the CPA.

Similarly in the final case, in Figure 5.4a, we can see that the horizontal projection stretches even further against the direction of the relative velocity. The area is approximately

³meaning the intruder at the coordinates (-1,0) would be heading towards the ownship, the intruder at the coordinates (1,0) has already passed the ownship

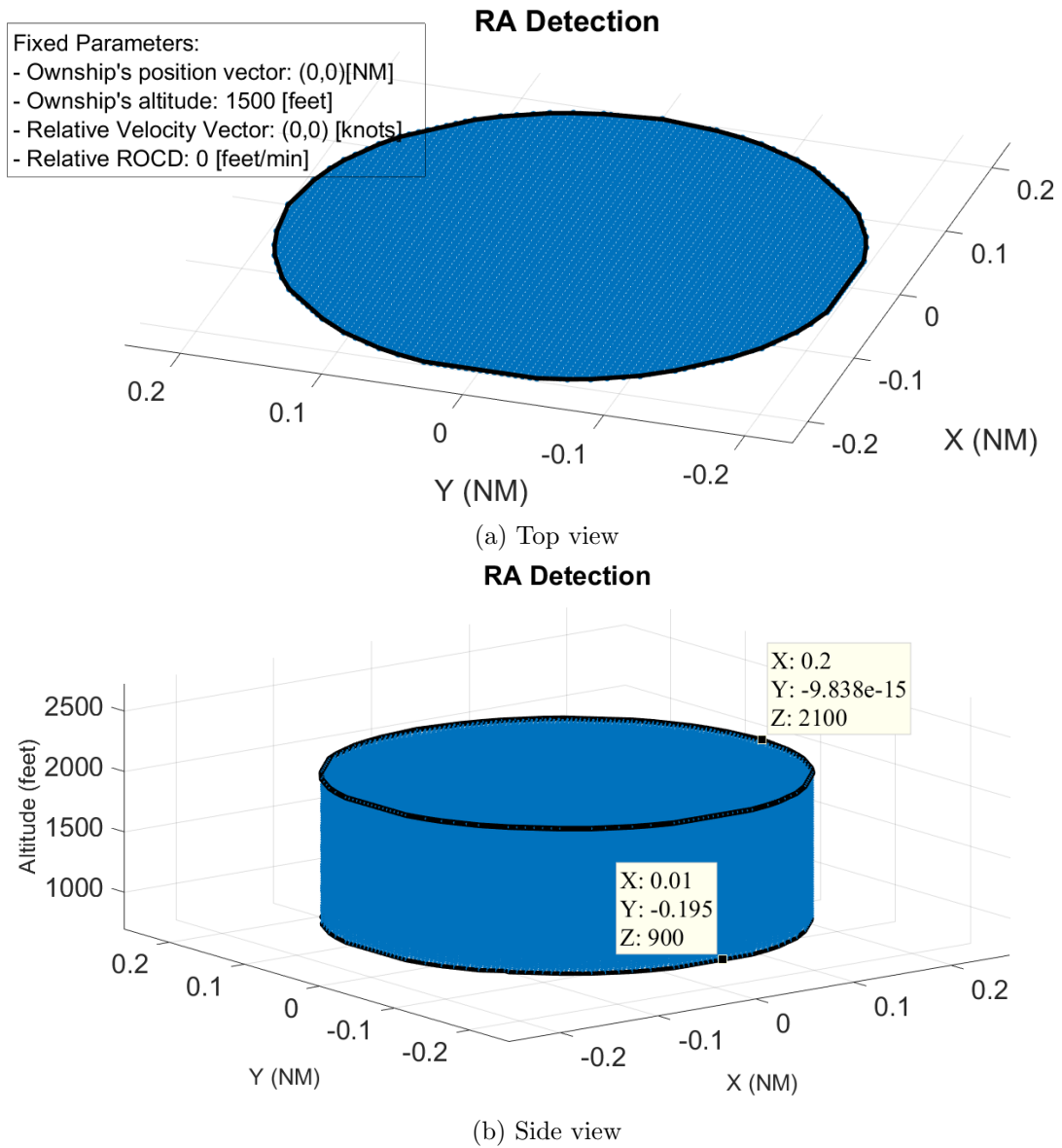

Figure 5.2: RA detection visualisation for zero relative velocity vector in Scenario 1

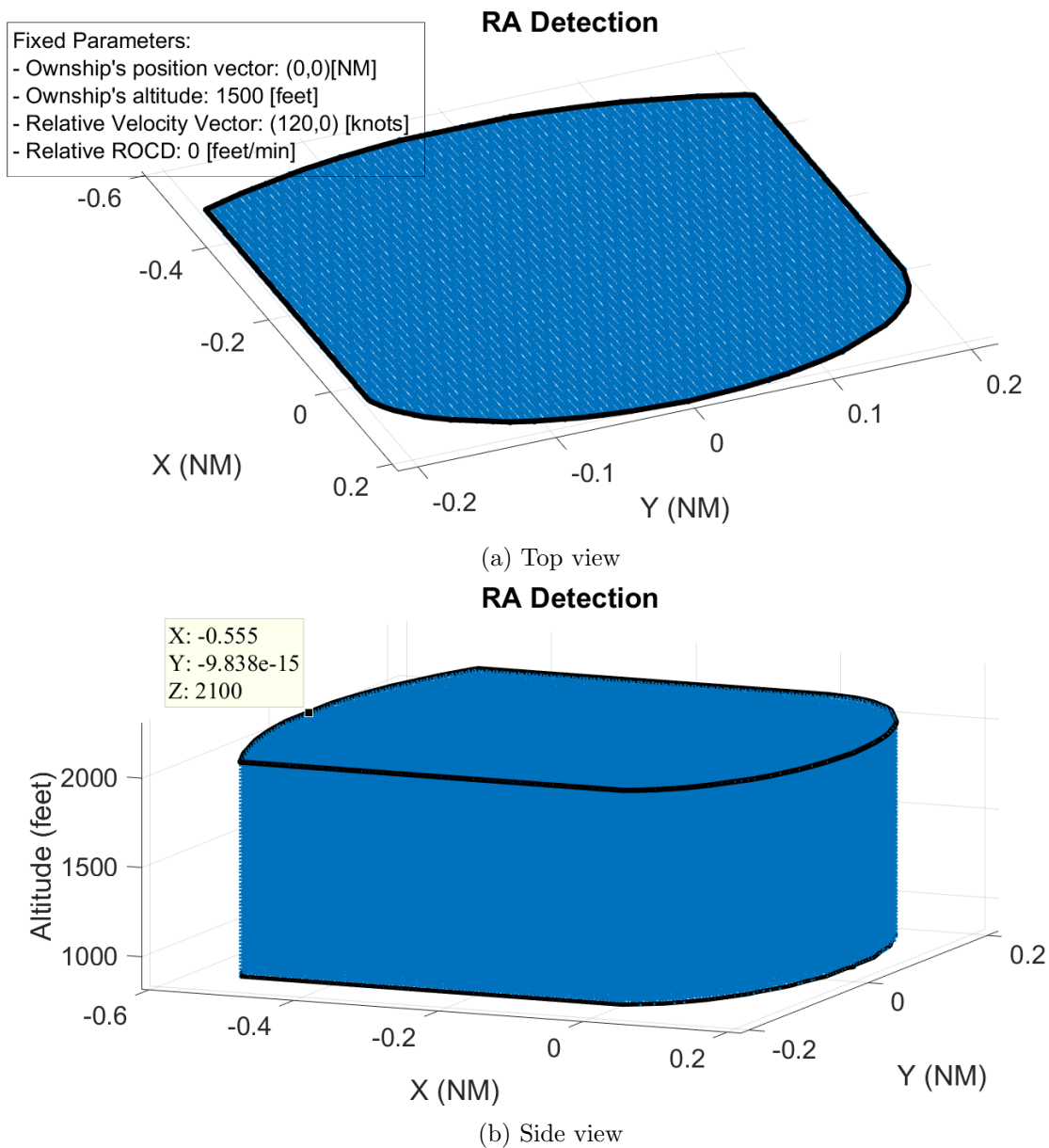

Figure 5.3: RA detection visualisation for the relative horizontal velocity of 120 knots in Scenario 2

three times larger than in Scenario 2 which is caused by the approximately three times higher relative velocity. In Figure 5.4b we have a data cursor showing us that the furthest distance in the negative X-axis direction where the RA is issued is -1.64 NM. If we calculate the time to the CPA as we did in the previous example, we obtain 15.2 seconds. Again, this value is higher than the TAU threshold, meaning the area is wide enough to provide the desired amount of time for the reaction. If we compare this value with the one that we obtained in Scenario 2, we can see that it is much closer to the TAU threshold. This is in accordance with the characteristic attributes of τ_{mod} . The τ_{mod} converges in the time to the CPA with the rise of the closure rate as described in Section 3.1.2.

Vertical Limits

Figure 5.2b shows a side view of the protected area in Scenario 1. The area is symmetrical, rising from 900 feet to 2100 feet as we can see from the data cursors. It extends exactly 600 feet above and below the ownship's position (1500 feet) as expected since the ZTHR threshold is 600 feet.

In Figure 5.3b, the height of the protected area remained the same as in Scenario 1 because there is no change of the vertical velocity or the sensitivity level.

In Figure 5.4b the data cursors capture the vertical boundaries of the RA issuance area. We can see that the lower boundary remains the same as in the other two scenarios (900 feet). The upper boundary is now 2250 feet instead of the 2100 feet previously forced by the ZTHR threshold. Because of the high ROCd (-3000 feet/min), in 15 seconds (TAU value) the relative vertical distance between the ownship and the intruder will decrease by 750 feet (if the ownship is below the intruder). An initial RA should provide at least the TAU amount of time before the collision, meaning the upper boundary of the protected area should be 750 feet above the ownship's position which corresponds to the 2250 feet upper boundary depicted in Figure 5.4b. From that, we can see that the vertical boundaries of the protected area change only for high relative ROCds.

5.2 RA Type Selection

This section focuses on the implementation of the logic which decides what type of RA should be issued. After the TCAS logic detects an RA, it needs to decide whether the RA is preventive or corrective. For a diagram of the RA type selection logic, see Figure 5.5. The RA type selection logic receives information about the relative position and velocity of the ownship and the intruders. Based on this data, it calculates the τ_{mod} to predict when the CPA will occur. It then extrapolates the trajectories of both the ownship and the intruder to the predicted CPA. Finally, the logic compares the predicted vertical separation at the CPA with the ALIM threshold for the given sensitivity level. If the vertical separation is higher than ALIM, no manoeuvre is required, and the RA is preventive. In that case, the aircraft are expected to miss each other with sufficient vertical separation. Otherwise, the RA is corrective and TCAS will recommend a resolving vertical manoeuvre to the pilot.

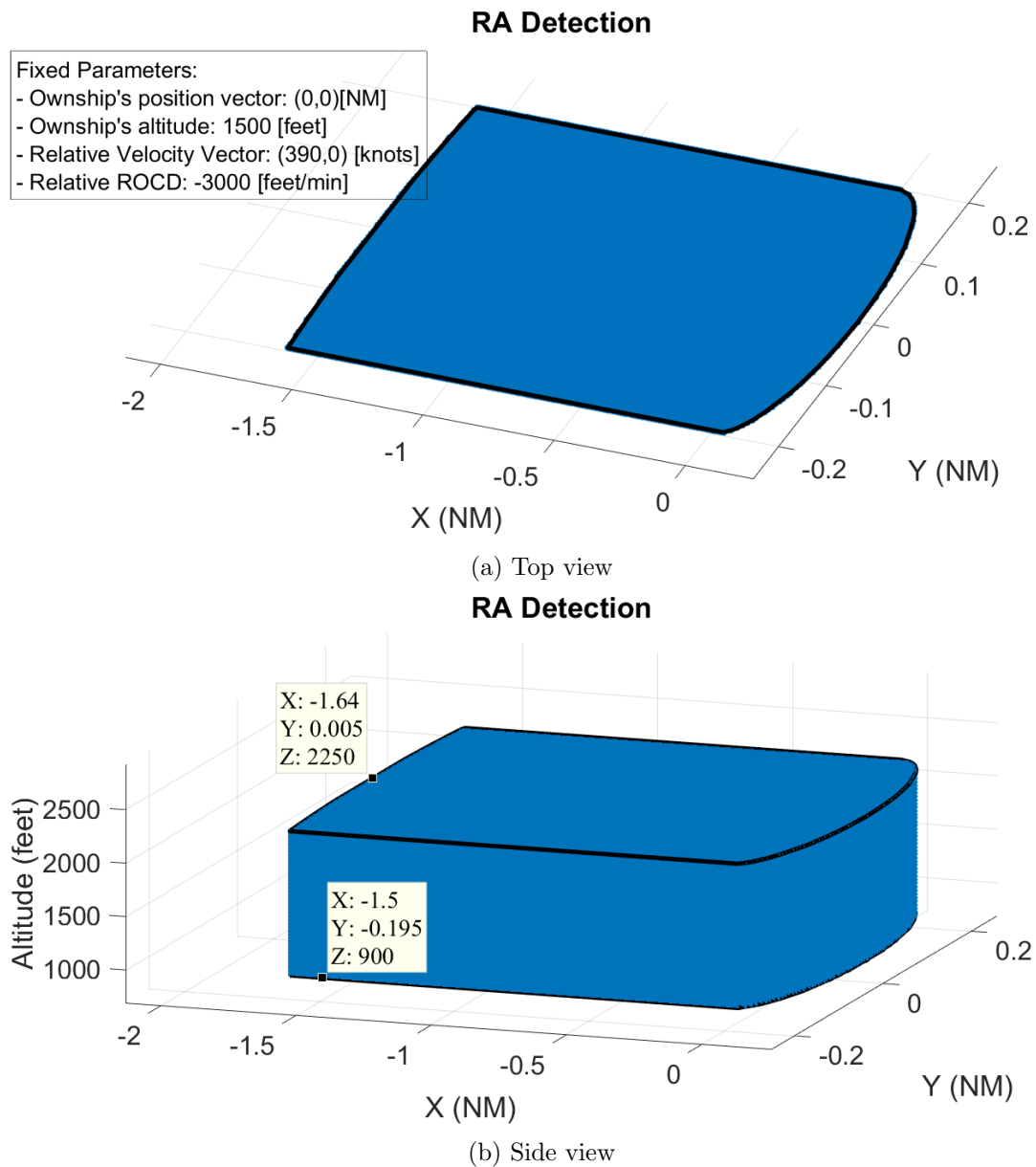

Figure 5.4: RA detection visualisation for the relative horizontal velocity of 390 knots and the relative ROCD of -3000 feet/min in Scenario 3

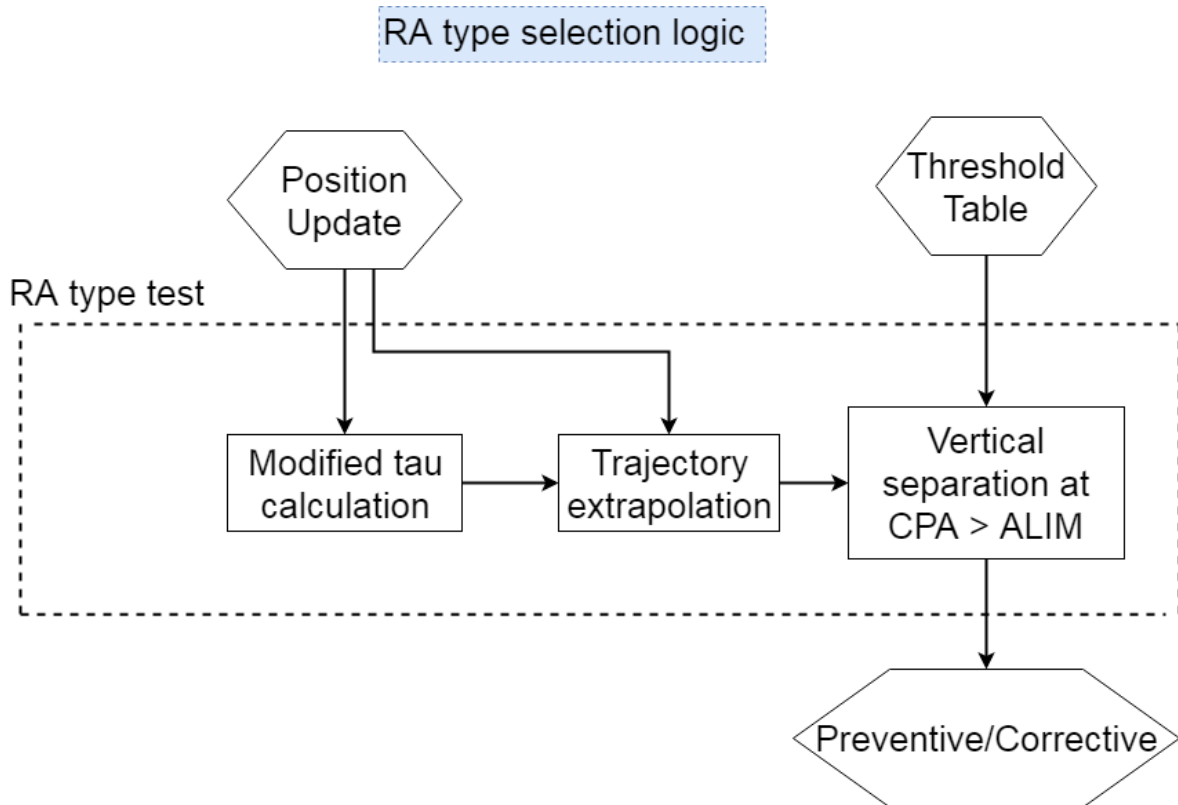

Figure 5.5: RA type selection logic diagram

5.2.1 Verification

To verify the functionality of the RA type selection logic, we use the same approach as in Section 5.1.1. Once again, we fix the ownship's position vector and the relative velocity vector between the aircraft, so we can iterate over the intruder's position and visualise how the response changes. The ownship's horizontal position is set to the coordinates (0,0) and its altitude at 1500 feet in all scenarios.

We use the following three test scenarios:

Scenario 1 — A simple case where the relative ROCD is set to 0 feet/min. The relative velocity is fixed to 195 knots (100 m/s). This situation can be seen in Figure 5.6.

Scenario 2 — The relative ROCD to 1000 feet/min. We leave all other parameters the same. This situation is visualised in Figure 5.7.

Scenario 3 — The relative ROCD is changed to -3000 feet/min to see how the logic works when the ROCD is high while the horizontal velocity is relatively low. This is pictured in Figure 5.8.

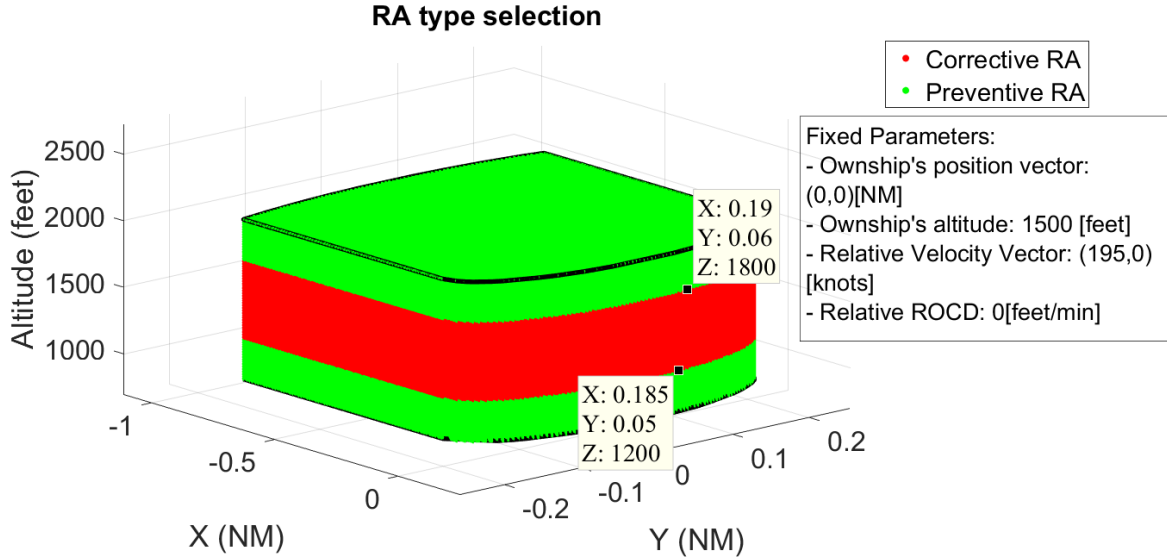

Figure 5.6: RA type selection visualisation for the relative horizontal velocity of 195 knots

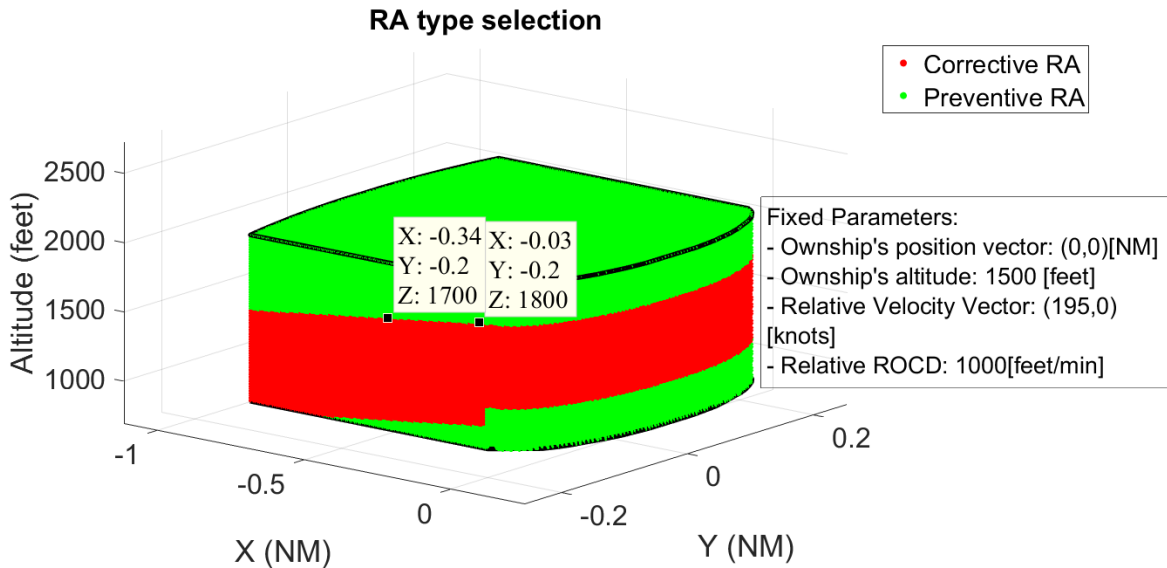

Figure 5.7: RA type selection visualisation for the relative horizontal velocity of 195 knots and the ROCD of 1000 feet/min

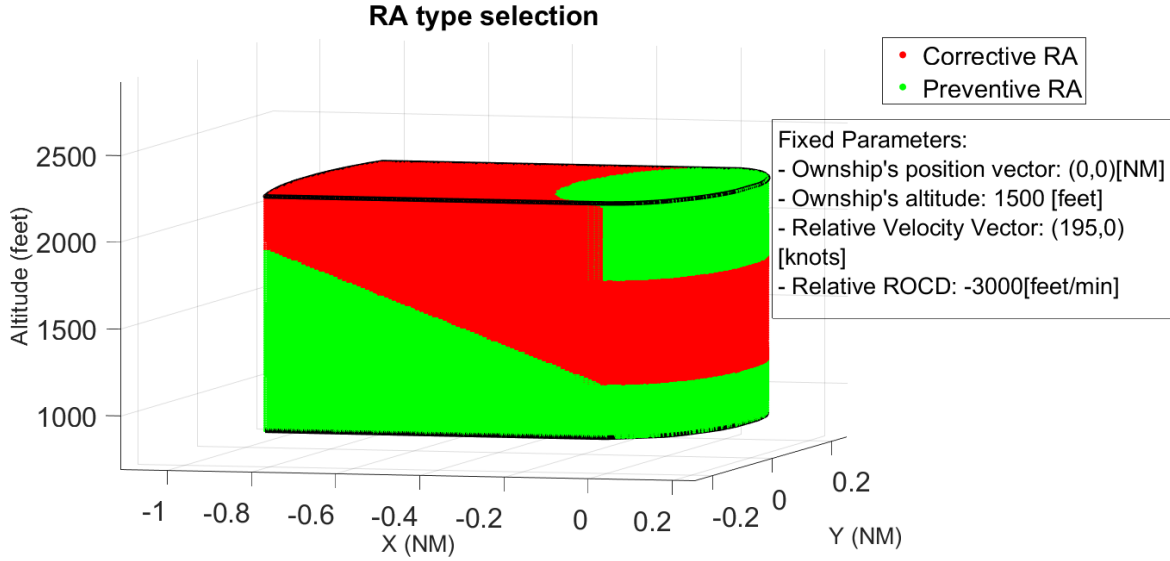

Figure 5.8: RA type selection visualisation for the relative horizontal velocity of 195 knots and the relative ROCD of -3000 feet/min

In Figure 5.6, we can see that the area where a corrective RA is issued is in the centre of the RA detection region and that it is horizontally aligned. As explained above, a corrective RA is issued only if the vertical separation at the CPA is predicted to be lower than the ALIM threshold. Because the relative ROCD is 0 in this scenario, the vertical separation stays the same during this encounter. This results in issuing corrective RAs only if the intruder's position is vertically closer than the ALIM. According to Table 3.1 the ALIM for this sensitivity level is 300 feet. Then, since the ownship's altitude is 1500 feet, the upper boundary for issuing a corrective RA is expected to be 1800 feet, and the lower boundary is expected to be 1200 feet. The plot in Figure 5.6 confirms that the boundaries are as expected.

When there is a non-zero relative ROCD, there are two areas where the logic behaves differently as depicted in Figure 5.7 and Figure 5.8. The first area is very close to the ownship's horizontal position (more accurately within the DMOD boundaries). Here, the corrective RAs are issued only if the intruder is within ALIM boundaries of vertical separation. The second area is further away from the ownship's horizontal position. In contrast to the first area, the corrective RA issuance area slopes up or down corresponding to the relative ROCD value in this case. This is caused by using the concept of τ_{mod} which is defined to approximate the time to enter the DMOD wide critical zone around the ownship. When the intruder is already inside the critical zone, τ_{mod} is at a constant minimum value of 0 seconds[14]. This causes the discrepancy between the area outside and inside the DMOD boundary.

The slope in Figure 5.7 is marked by two data cursors. For the given ROCD and relative velocity, we can calculate that it takes the same amount of time to travel the horizontal distance between the data cursors as it takes to travel the vertical distance between the data cursors. This confirms that the slope is copying the relative horizontal/vertical velocity ratio. Thus, the area where a corrective RA is issued is basically the area where the intruders

are pointed towards the critical zone⁴ around the ownship's position. If the intruders are not within this area, they are predicted to miss the ownship with sufficient vertical separation and a preventive RA is the correct way to address them. In the case where an intruder appears in the DMOD wide zone around the ownship, a corrective RA is issued only if the current vertical separation is lower than the current ALIM value. From the shape of the areas in Figure 5.7 and Figure 5.8, we can see that it is constructed so that the logic issues a corrective RA in advance in the case where the intruder is heading towards the critical area.

5.3 RA Sense and ROCD Selection

This section focuses on the implementation of the logic which decides what manoeuvre will be recommended to the pilot. A diagram of the logic can be seen in Figure 5.9.

When a corrective RA has been detected, it is necessary to choose the best vertical manoeuvre to preserve the vertical separation. We iteratively test if the currently inspected manoeuvre is a valid resolution of the conflict. For this purpose, a vertical manoeuvre is defined by the change of the ROCD (further referred to as Δ ROCD) and the RA sense. The optimal manoeuvre causes the smallest possible deviation from the original flight path while maintaining the level of protection. Δ ROCD is set to the lowest value and iteratively increases it when the manoeuvre does not provide the desired level of protection defined by the ALIM threshold of the vertical separation.

Before the iterative testing of the manoeuvres, the data from the latest position update is used to calculate the τ_{mod} for each intruder. These values are then used in every iteration to define the set of CPAs which are critical points in time where we need to provide a sufficient vertical separation.

The manoeuvre validity test first checks the feasibility of the manoeuvres. If it holds that

$$(\text{the current ownship's ROCD}) + \Delta\text{ROCD} > \text{ROCD}_{MAX} \quad (5.1)$$

$$\text{and } (\text{the current ownship's ROCD}) - \Delta\text{ROCD} < \text{ROCD}_{MIN} \quad (5.2)$$

then there is no feasible manoeuvre that would provide ALIM at all CPAs. In such a case, safety is the priority and the manoeuvre providing the highest vertical separation at CPAs is chosen. This can happen in a particularly difficult multiple-threat encounter.

5.3.1 Verification

To verify the RA sense selection logic, we again iterate over the intruder's position while the relative horizontal velocity, ROCD and ownship's position remain fixed. The ownship's position and therefore the sensitivity level remains the same as in the previous examples. This time, we focus on visualising the RA sense selection logic to inspect the preference in

⁴DMOD wide and ALIM high zone

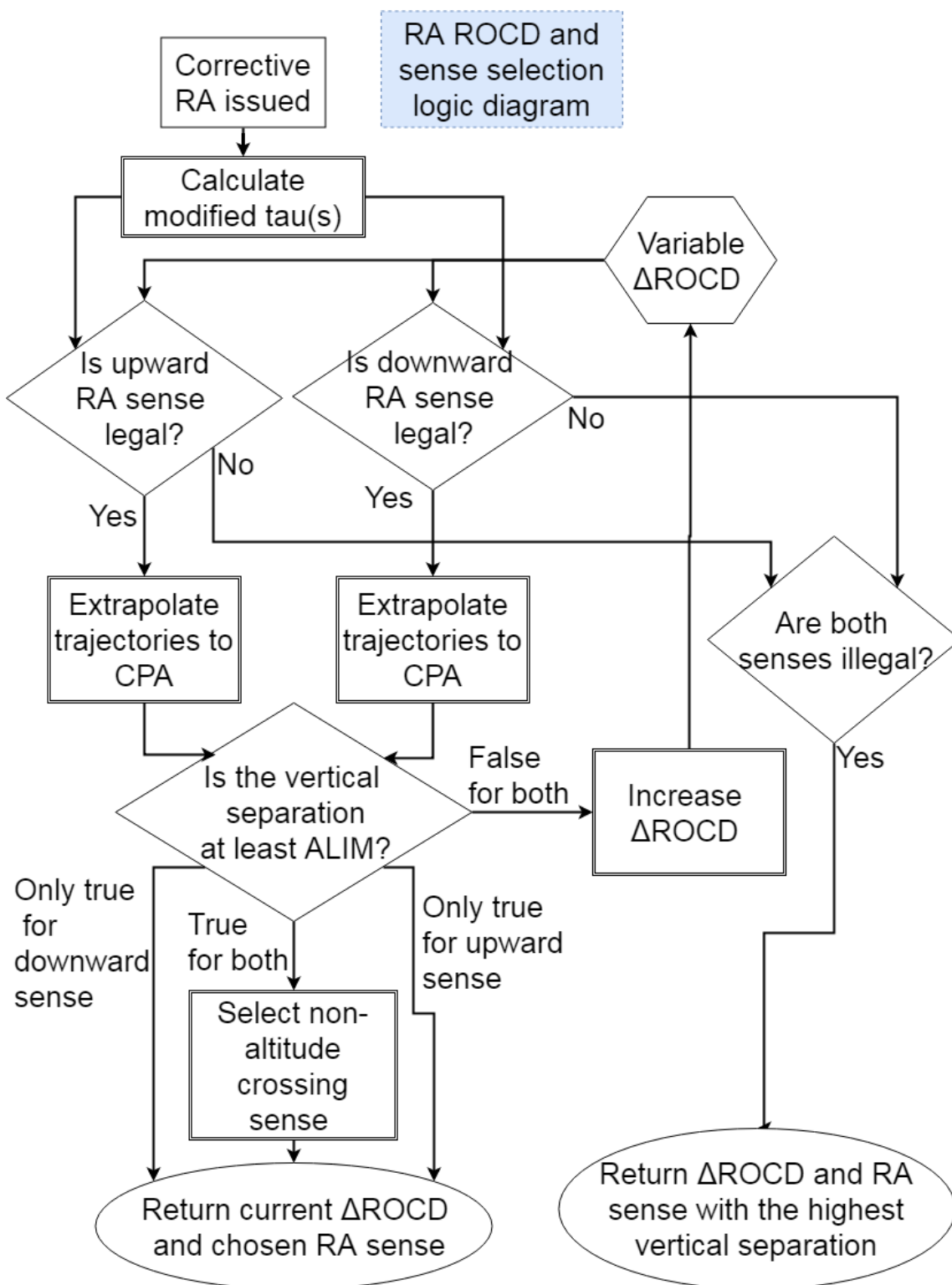

Figure 5.9: RA ROCD and sense selection logic diagram

manoeuvres. The approach we choose in this section enables us to observe the behaviour of the logic only in a single-threat encounter. Multiple-threat encounters are analysed in Section 6.4.

The following scenarios are used to show the RA sense selection functionality:

Scenario 1 — A simple case where the relative ROCD is set to zero, and horizontal velocity is set to 195 knots. The graph of this scenario can be seen in Figure 5.10.

Scenario 2 — The intruder’s ROCD is raised to -3000 feet/min, while the ownship’s ROCD remains at 0 feet/min. All the other parameters remain the same as in the previous scenario. The resulting RA sense selection graph is depicted in Figure 5.11.

Scenario 3 — The ownship’s ROCD is set to 4300 feet/min which is almost the maximum value. The intruder’s ROCD is set to 1300 feet/min, which causes the relative ROCD to be the same as in Scenario 2. The horizontal velocity remains at the value of 195 knots. The visualisation of the RA sense logic for this scenario is depicted in Figure 5.12

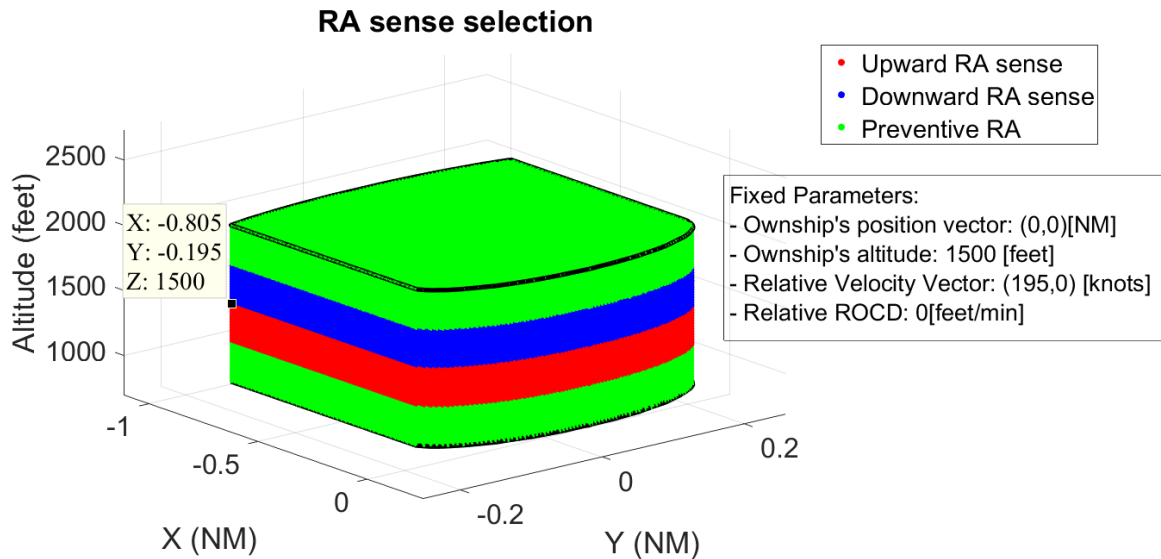

Figure 5.10: RA sense selection visualisation for the relative horizontal velocity of 195 knots

In Scenario 1, the relative ROCD is set to zero, and an RA sense is selected simply based on the relative altitude. While reacting to a threat which is below the ownship’s position (1500 feet), corrective advisories prefer the upward RA sense since it is more likely to provide the sufficient vertical separation and also it is a non-altitude crossing sense. Similarly, the downward RA sense is selected when the intruder is above the ownship.

During the RA sense selection a very high/low value of the ownship’s ROCD can cause the otherwise optimal upward/downward sense to not be selected because of the upper/lower limit for the ROCD. Otherwise, the absolute ROCD of the ownship does not affect the decisions made by the RA sense selection logic. In Scenario 2, the corrective RA area is divided by a line reaching towards the ownship’s position with a slope corresponding to the ratio

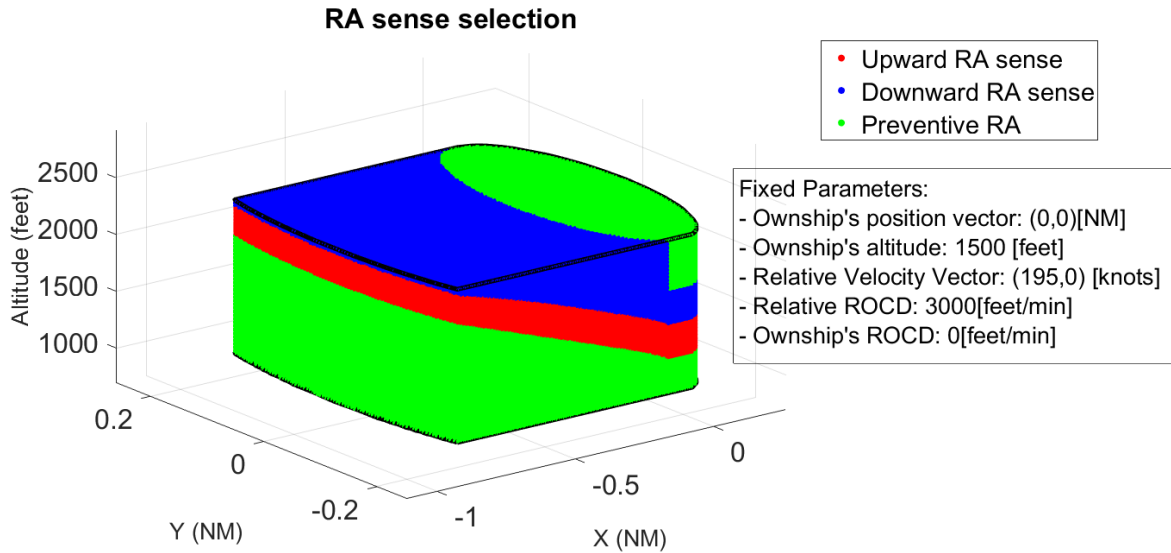

Figure 5.11: RA sense selection visualisation for the relative horizontal velocity of 390 knots and the relative ROCD of 3000 feet/min

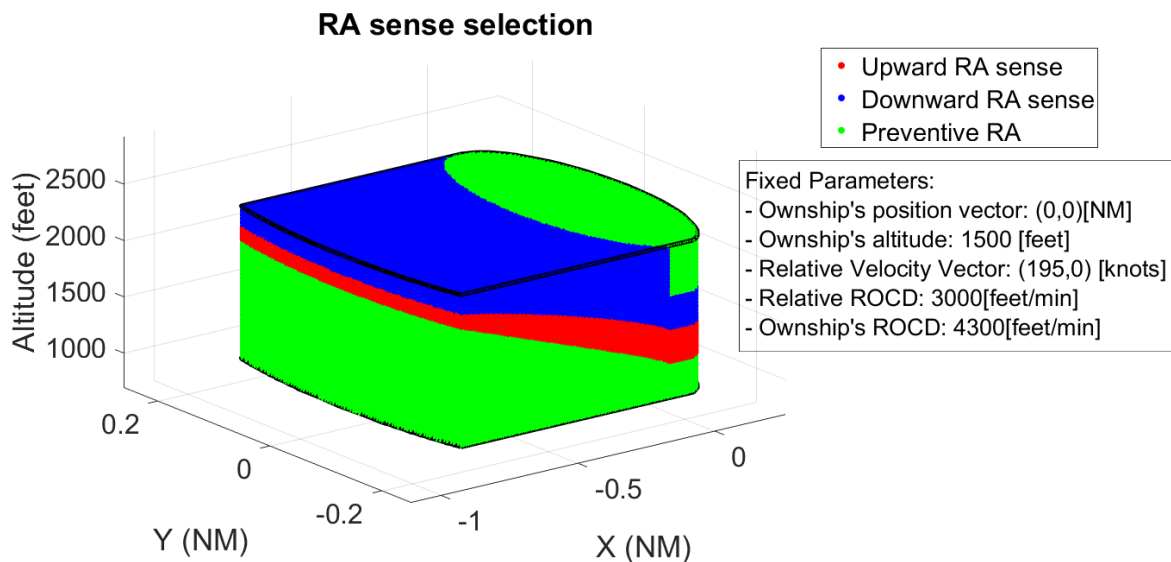

Figure 5.12: RA sense selection visualisation for the relative ROCD of 3000 feet/min and ownship's ROCD of 4300

between the relative horizontal velocity and ROCD. Then, the upward RA sense is picked if the intruder's position at the CPA is expected to be below the ownship. In Scenario 3, the upward RA sense area is smaller than in Scenario 2. This is caused by the maximum ROCD limit which is 4400 feet/min as shown in Table 3.2. This causes the upward RA sense to be invalid for a higher Δ ROCD as the final ROCD cannot go over the limit. As a result, for certain positions, the downward RA sense is selected with a higher Δ ROCD than in the case where the ownship's velocity is not near the limit.

5.4 Composition of the TCAS Logic

This section describes how the previously introduced parts of the RA logic work together. The functionality is depicted in Figure 5.13. When a new position update arrives, it is first sent to the RA detection logic. If a threat is detected within the protected area, the RA is issued. Otherwise, the default flight path is kept without any constraints. In the case where an RA is issued, its type is selected. In the case of preventive RAs, changes to the current ROCD are restricted. In the case of corrective RAs, it is required to specify a manoeuvre which will resolve the situation.

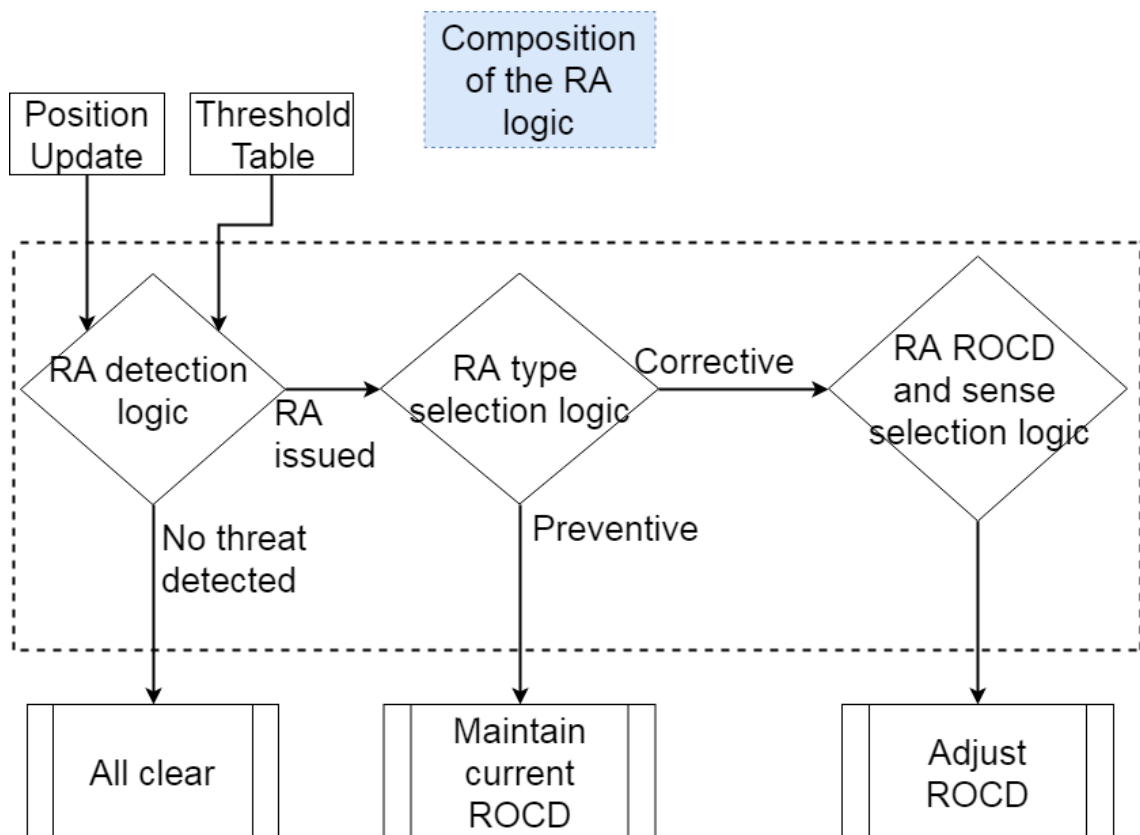

Figure 5.13: Diagram of the RA logic composition

The verification of the whole RA logic is the focus of Chapter 6 where a discrete encounter simulation is used for this purpose. The RA logic is then further used in Chapter 7 where it is integrated within the air traffic simulation and used for precise encounter simulation.

Chapter 6

Discrete Encounter Simulation

We use a simple discrete encounter simulation to inspect how the composition of the RA logic works. The goal of this chapter is to verify the functionality of the RA logic in various scenarios. The discrete encounter simulation addresses single and multiple-threat encounters together with unpredictable manoeuvres performed by the intruders. Coordinated encounters are not to be tested using this simulation as it lacks a model of aircraft communication. The coordinated encounters simulation is included in Chapter 7.

This simulation uses a point-mass model of aircraft and takes the maximum and minimum ROCD constraints into account. The ownship's initial manoeuvres are simulated with an acceleration of 0.25 g which is in accordance with what the TCAS logic assumptions described in Section 3.2.

6.1 Encounter Definition

This section introduces and explains the encounter parametrisation. This parametrisation is then used both in the discrete encounter simulation (Chapter 6) and in the air traffic simulation (Chapter 7) for the purpose of verifying and analysing the collision avoidance system. Figure 6.1 illustrates the encounter parametrisation.

Each aircraft in the encounter can be characterised by four parameters:

- Initial horizontal position vector \vec{p} [NM]
- Initial altitude h [feet]
- Initial horizontal velocity vector \vec{v} [m/s]
- Initial ROCD dh [feet/min]

This parametrisation suits the stochastic encounter simulation but it is impractical for our simulation. As explained in Section 4.2.3, our focus is to analyse the impact of specific input parameters on the simulation and find specific boundaries of the TCAS functionality. For that, we need a parametrisation that would allow us to change the parameters of interest, and see their sole impact on the encounter resolution.

The modification of a single parameter causes the prior vertical separation (the word prior is used to refer to what the trajectories of the encounter would look like without the interventions by the collision avoidance system) to change. Since the prior vertical separation characterises the "difficulty" of the encounter, we cannot iterate over a single parameter of

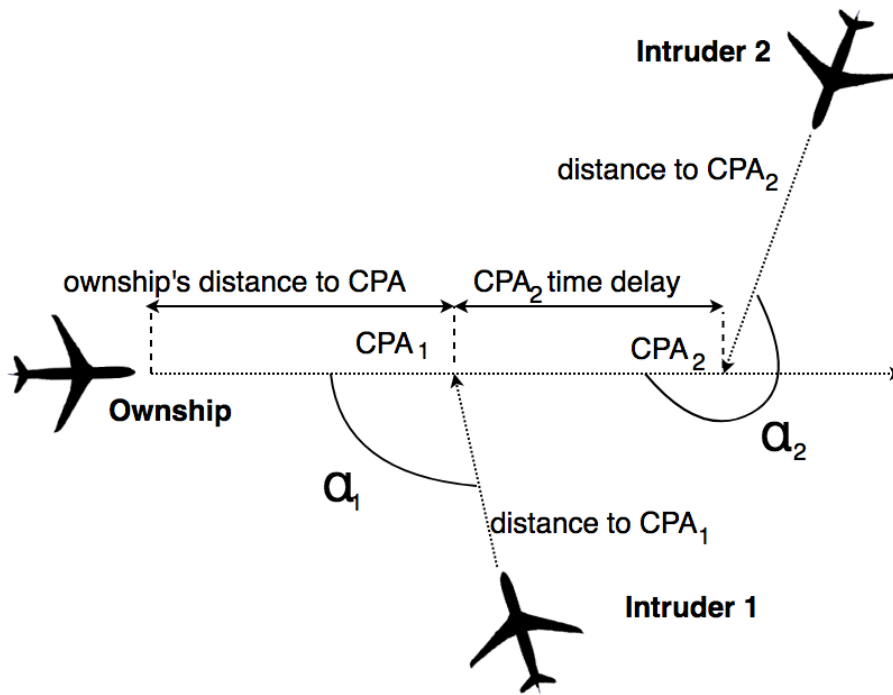

(a) Top view

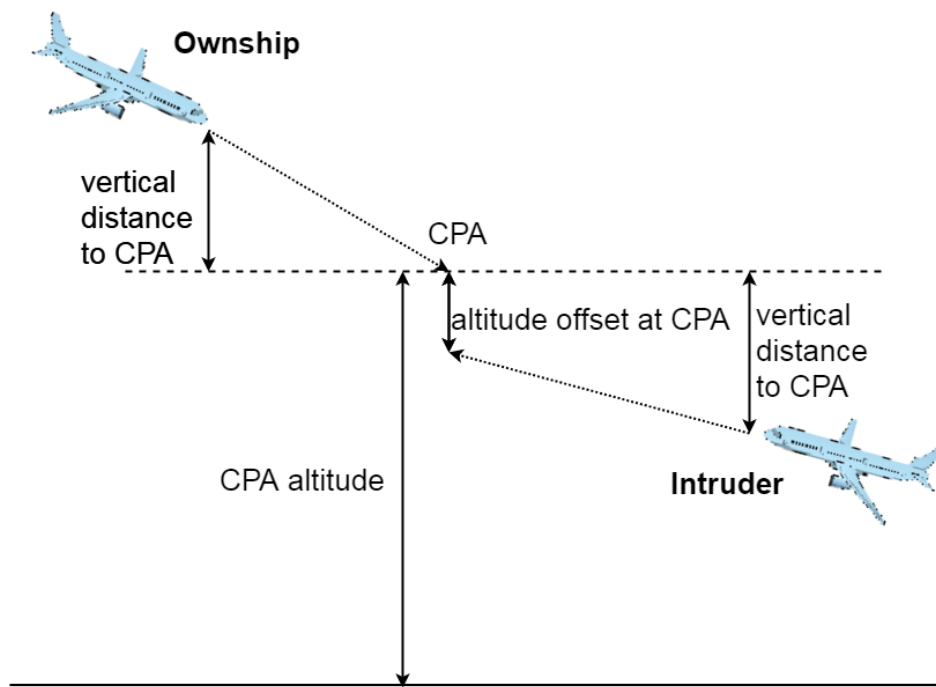

(b) Side View

Figure 6.1: Illustration of the simulation parameters

the simulation to see how it affects the collision avoidance system's functionality. To observe how the change of the aircraft's initial horizontal velocity and ROCD affects the encounter resolution, we need to keep the prior vertical separation constant. This can be done using the following encounter definition.

The horizontal position of the CPA is fixed ($\vec{p}_{CPA} = (0, 0)$), as it does not affect the collision avoidance logic in any way, while the other parameters are iteratively changed. The altitude of the CPA, h_{CPA} , is a parameter used to change the sensitivity level. Parameter α specifies the angle of approach, it allows us to have the absolute horizontal velocity, $v \equiv |\vec{v}|$, as a parameter instead of \vec{v} . The last parameter we need to define is, t_{CPA} , the time it takes the aircraft to reach the CPA from the beginning of the simulation. The value of t_{CPA} has to be high enough so that the aircraft in the simulation do not begin in the RA detection region. If this condition is fulfilled, the value of t_{CPA} does not affect the encounter and can be derived from the input velocities and TAU, DMOD and ZTHR values of the current sensitivity level.

The parameters characterising the aircraft in the encounter can be then estimated as follows:

$$\vec{v} = (v \cos \alpha, v \sin \alpha), \quad (6.1)$$

$$\vec{p} = \vec{p}_{CPA} - t_{CPA} \vec{v}, \quad (6.2)$$

$$h = h_{CPA} - t_{CPA} dh, \quad (6.3)$$

dh remains as an input parameter, and the ownship's horizontal velocity is defined as $\vec{v}_{ownship} = (v_{ownship}, 0)$.

In a multiple-threat encounter, we define the consequent CPAs using the time it will take the ownship to reach them after the first CPA, then we can define additional intruders the same way that the intruder in the single-threat encounter is defined.

If we add the parameters of the pilot response model (described in Section 4.2.5) and a necessary parameter defining if the particular intruder is equipped with an operating TCAS or not, we reach the following final set of input parameters for the simulation:

- Pilot response model parameters¹
 - Initial pilot response delay rd_{init} [s]
 - Consequent pilot response delay rd_{cons} [s]
 - RA response age ra_{age} [s]
- Ownship's
 - initial (absolute) horizontal velocity v [m/s]
 - initial ROCD dh [feet/min]
 - desired sensitivity level sl [-] (from which the ownship's altitude at the first CPA is derived)
- Each Intruder's
 - is TCAS active? [-]

¹the pilot response model is utilised in Chapter 7 for the simulation of reaction delays

- time delay from the first CPA td_{CPA} ²[s]
- initial horizontal velocity v [m/s]
- initial ROCD dh [feet/min]
- approach angle α [°]
- (optional) prior altitude offset at the CPA [feet]
- (optional) prior horizontal offset at the CPA [NM]

Using the proposed parametrisation of the encounter, we can easily iterate over a single parameter and see its influence on the resulting characteristics. The purpose of the TCAS logic is to provide sufficient vertical separation at the CPA. The output characteristic of the encounter that characterises the collision avoidance system’s performance the most is the vertical separation at the CPA³. To characterise the system’s promptness to respond to the intruder’s approach, the ”reaction time” which captures how many seconds before reaching the CPA the ownship started manoeuvring is used.

6.2 Single-threat Encounters

When simulating the encounters, we want to observe the manoeuvre recommended by the collision avoidance logic and the resulting VMD at the CPA. So, to compare the collision avoidance logic reactions to different encounters, we plot the trajectories of the aircraft in the encounters in a 3-D graph and highlight the CPA and the corresponding vertical separation.

In the following encounter scenarios, the CPA is placed at the coordinates: (0,0) and at FL 150. For the corresponding sensitivity level, the value of ALIM is 400 feet, and the TAU threshold is set to 30 seconds (for the complete list of thresholds see Table 3.1). The angle α is set to 180°. The t_{CPA} is 40 seconds to provide a reasonable amount of time before reaching the RA detection region and the prior horizontal and vertical distance at the CPA is fixed to zero. The end of the simulation is set to be 5 seconds after the aircraft reach the planned CPA.

To test the collision avoidance system functionality, we inspect 4 scenarios with different initial ownship’s and intruder’s ROCDs and horizontal velocities. The sets of parameters defining the scenarios are filed in Table 6.1. Trajectories of the encounters are visualised in figures 6.2-6.5 for scenarios 1-4, respectively. The resulting VMD in each scenario can be derived from the data cursors which are highlighting the CPA.

In Scenario 1, the VMD is slightly higher than the ALIM threshold. With the rise of the relative ROCD in the two next scenarios, the VMD rises too. It may appear that the collision avoidance system is causing unnecessary deviations. This is because it protects a critical DMOD wide area around the ownship, and not just the point in the space where the aircraft is predicted to be as explained in Section 3.1.2. In Scenario 3, this leads to a very high VMD (1070 feet) at the CPA because of the extremely high relative ROCD (6000 feet/min) combined with the high DMOD value (0.8 NM).

²used in the multiple-threat encounters

³also referred to as the VMD (Vertical Miss Distance)

Table 6.1: Single-threat encounters — Scenario specific parameters

		Parameter values			
Scenario number		1	2	3	4
Ownship	Horizontal velocity [m/s]	100	100	100	150
	ROCD [feet/min]	0	-3000	-3000	-3000
Intruder	Horizontal Velocity [m/s]	100	100	100	150
	ROCD [feet/min]	0	0	3000	3000

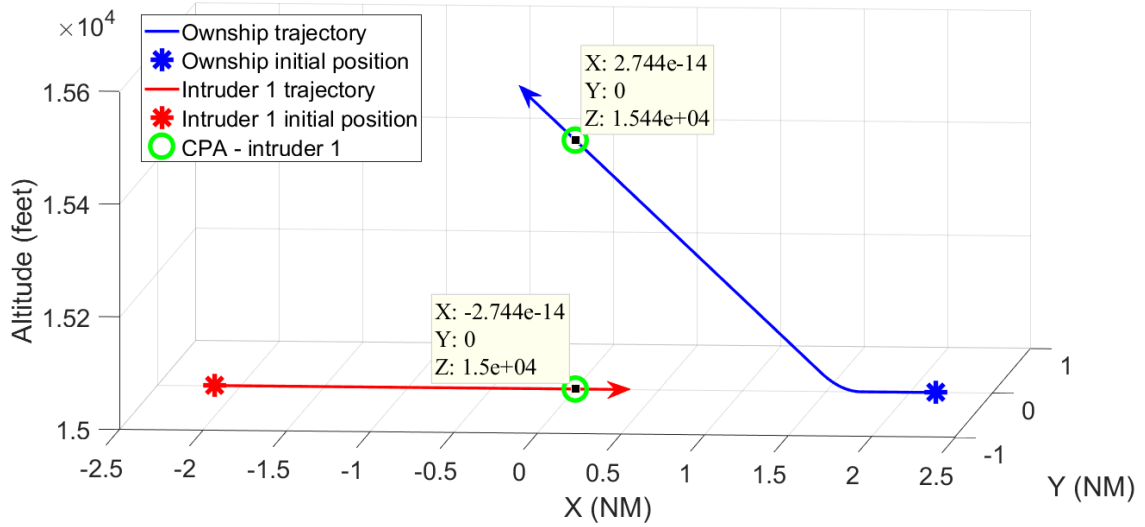

Figure 6.2: Encounter simulation of single-threat encounter – Scenario 1

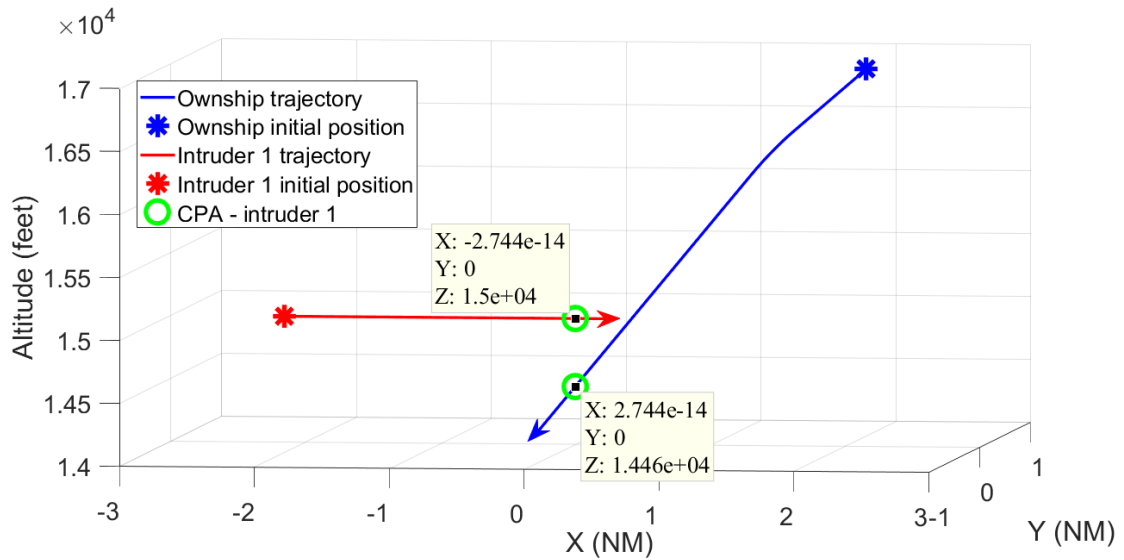

Figure 6.3: Encounter simulation of single-threat encounter – Scenario 2

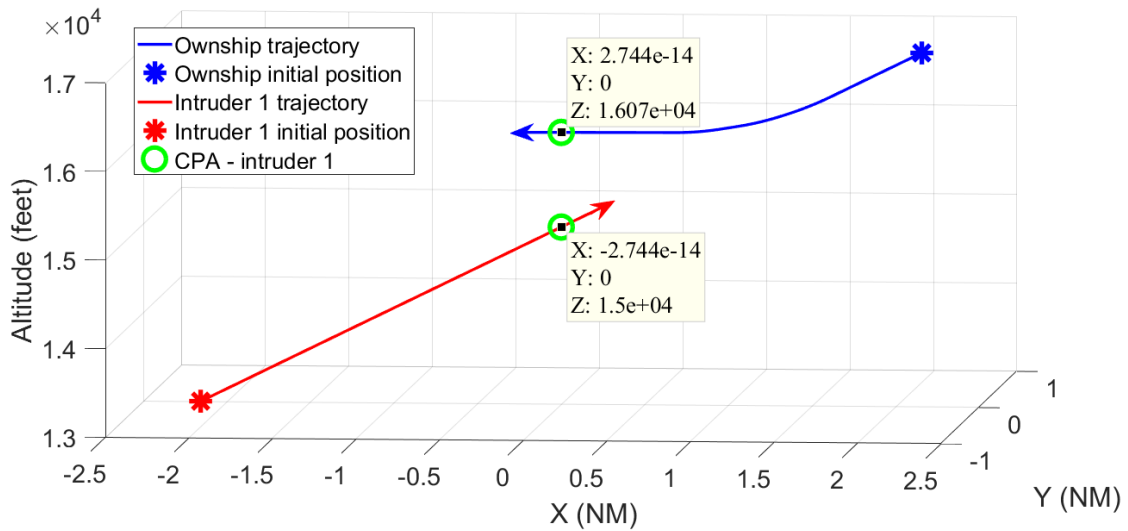

Figure 6.4: Encounter simulation of single-threat encounter – Scenario 3

Since at least the ALIM vertical separation should be provided upon entering the critical area, the vertical separation at the actual CPA will be higher, especially if the relative ROCD is high. If we raise the horizontal closure rate to 300 m/s (see Figure 6.5), the time interval during which the intruder is passing through the critical zone shortens. That enables the collision avoidance system to make a weaker manoeuvre while still providing the ALIM vertical separation throughout the whole critical zone. As we can see in Figure 6.5, this resulted in the VMD of 550 feet and also in using the opposite RA sense which is preferable. This RA sense was not available in the previous case because even the manoeuvre using the minimum value of the ROCD was not strong enough to provide the ALIM separation throughout the whole critical zone.

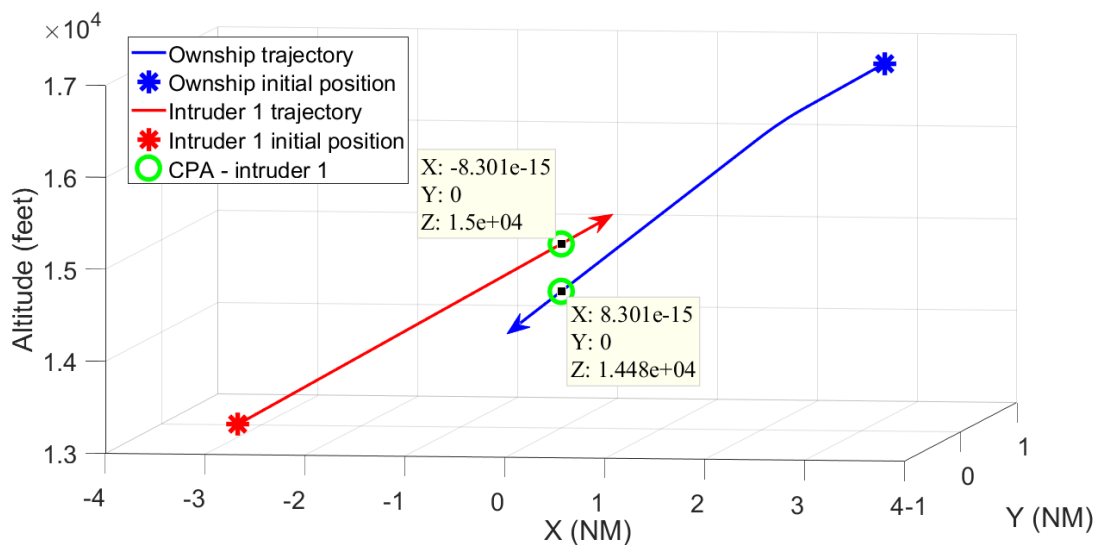

Figure 6.5: Encounter simulation of single-threat encounter – Scenario 4

6.3 Reaction to Intruder's Manoeuvres

Next, we test how the collision avoidance logic reacts to possible sudden changes in the intruder's velocity. We use the previously introduced encounter depicted in Figure 6.2, and add a sudden manoeuvre performed by the intruder. Figure 6.6 shows the resulting collision avoidance manoeuvres. The intruder accelerates to 2000 feet/min just 10 seconds before the CPA

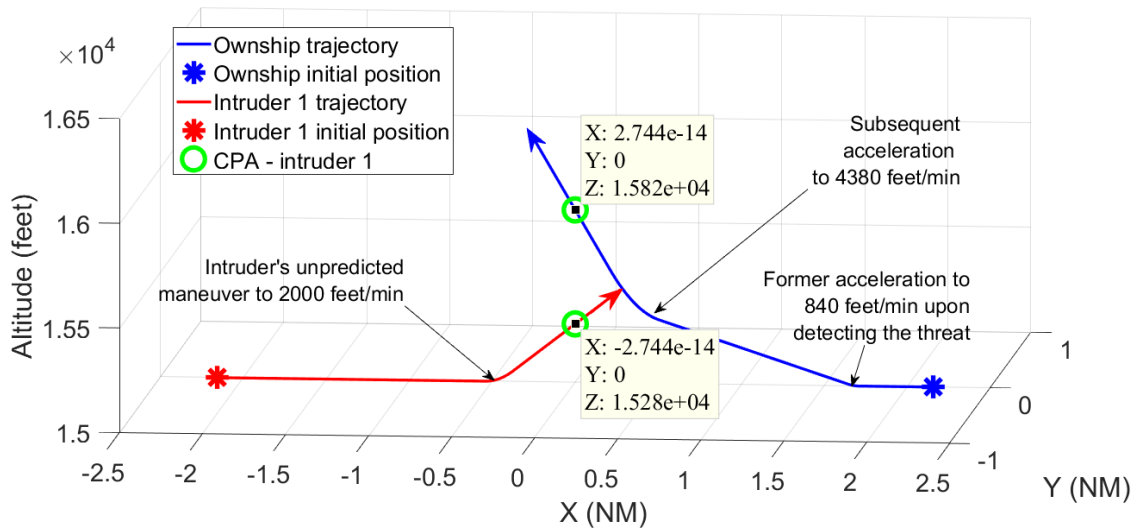

Figure 6.6: Trajectory simulation - intruder accelerates to 2000 feet/min 10 seconds prior to the CPA

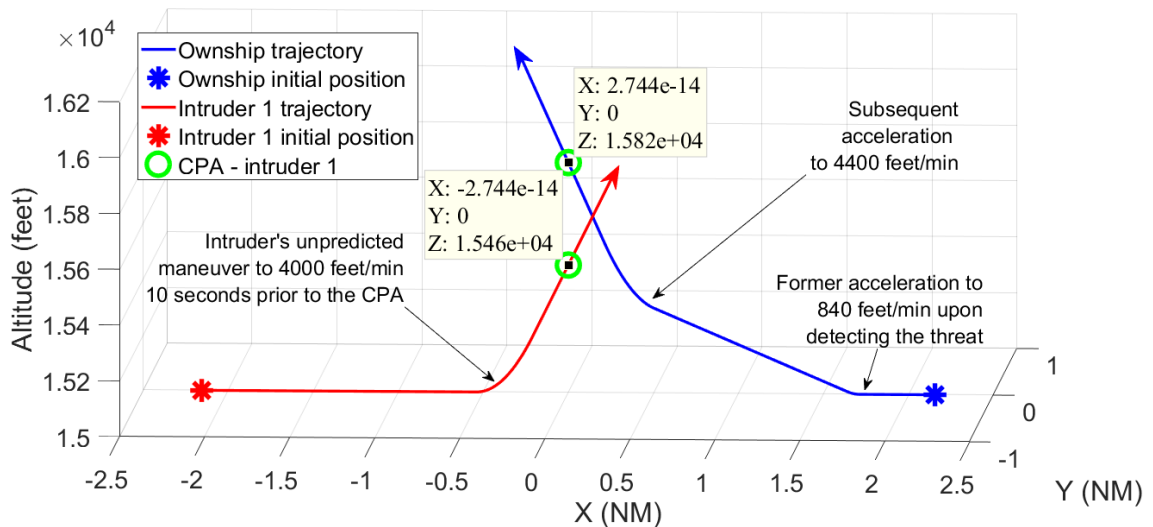

Figure 6.7: Trajectory simulation - intruder accelerates to 4000 feet/min 10 seconds prior to the CPA

reaching the CPA. The ownship reacts by a subsequent RA to increase the ROCD almost to the maximum. The resulting VMD is 540 feet which confirms that the collision avoidance system was able to react to such a situation, mainly thanks to there being no delays in response to the subsequent RA issuance.

Figure 6.7 depicts a similar encounter where the intruder accelerates to 4000 feet/min, making it more difficult for the ownship to avoid the loss of separation. The VMD is 360 feet which is below the ALIM threshold. In the cases where no RA can provide at least the ALIM separation, the RA providing the largest vertical separation is issued. The encounter is considered to be an NMAC when the vertical separation decreases under 100 feet.

The collision avoidance logic works as expected while dealing well with the single-threat encounters. Next, its performance in the multiple-threat encounters is tested using the simulation.

6.4 Multiple-threat Encounters

First, we focus on how the delay between the different CPAs impacts the encounter. We compare two cases where:

- The ownship’s CPAs with both intruders coincide (depicted in Figure 6.8a).
- The ownship’s CPAs with the second intruder is delayed by 10 seconds (depicted in Figure 6.8b).

The fixed parameters are listed in Table 6.2.

Table 6.2: Values of Fixed Parameters - multiple-threat encounter

	Ownship	Intruder 1	Intruder 2
Approach angle α [°]	–	180	180
Horizontal Velocity [m/s]	100	100	100
ROCD [feet/min]	0	0	0
Altitude Offset [feet]	–	-100	400
Sensitivity level	4		

In the figures, we can see that in both cases the VMD is higher than the ALIM threshold (300 feet) at both intruder’s CPAs. Different evasive manoeuvres were chosen. In the former case, there is a considerably smaller deviation from the original flight path. Then, the resolution which was used in the first encounter would be a better solution for the second encounter than the one that was actually used. This is due to the initial reaction beginning before the collision avoidance system detects the second intruder. It turns out that in multiple-threat encounters, there are phases where the logic only counts on a partial amount of the intruders and the advisories may change when a new threat is close enough to be detected.

A similar situation occurs when a threat passes through the CPA and is no longer a threat. The collision avoidance logic then adjusts the RA to one that resolves conflicts with

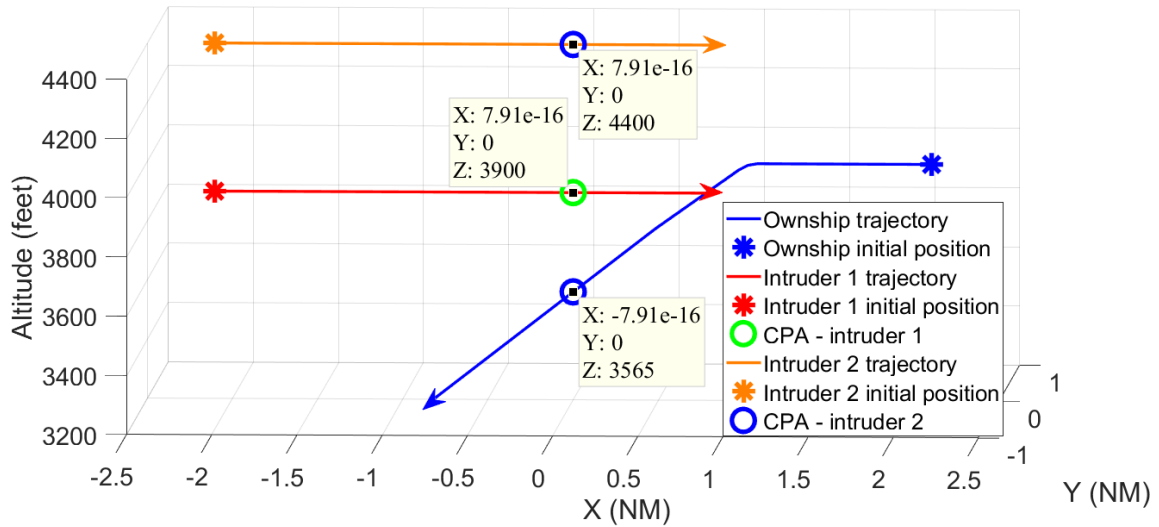

(a) The second intruder's CPA delay = 0s

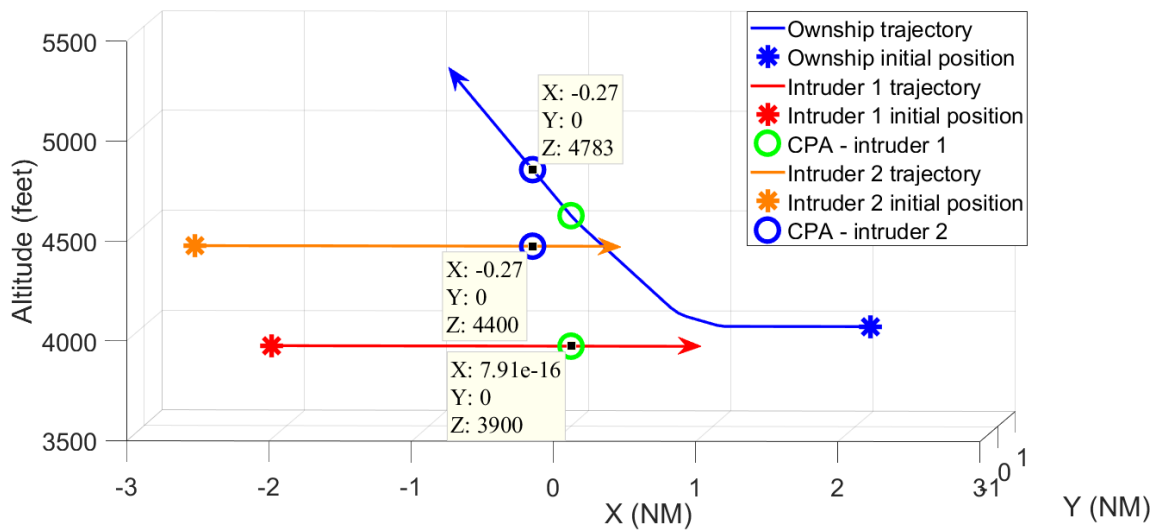

(b) The second intruder's CPA delay = 10s

Figure 6.8: Multiple-threat encounters - the CPA delay impact

the remaining intruders in an optimised way. An instance of such a situation can be seen in Figure 6.9. The parameters defining the encounter are listed in Table 6.3. The evasive manoeuvre was successful as the VMD with both intruders is slightly above the ALIM threshold (300 feet).

Finally, we want to inspect how the collision avoidance logic's decisions change based on manipulation of the encounter parameters. We adjust the parameters to create encounters where the collision avoidance logic is forced to seek different solutions. We aim to confirm

Table 6.3: Values of Fixed Parameters - multiple-threat encounter with RA reversal

	Ownship	Intruder 1	Intruder 2
Approach angle α [°]	–	180	180
Horizontal Velocity [m/s]	75	75	75
ROCD [feet/min]	0	0	-1000
Time Delay of CPA [s]	–	0	10
Altitude Offset [feet]	–	0	760
Sensitivity level	4		

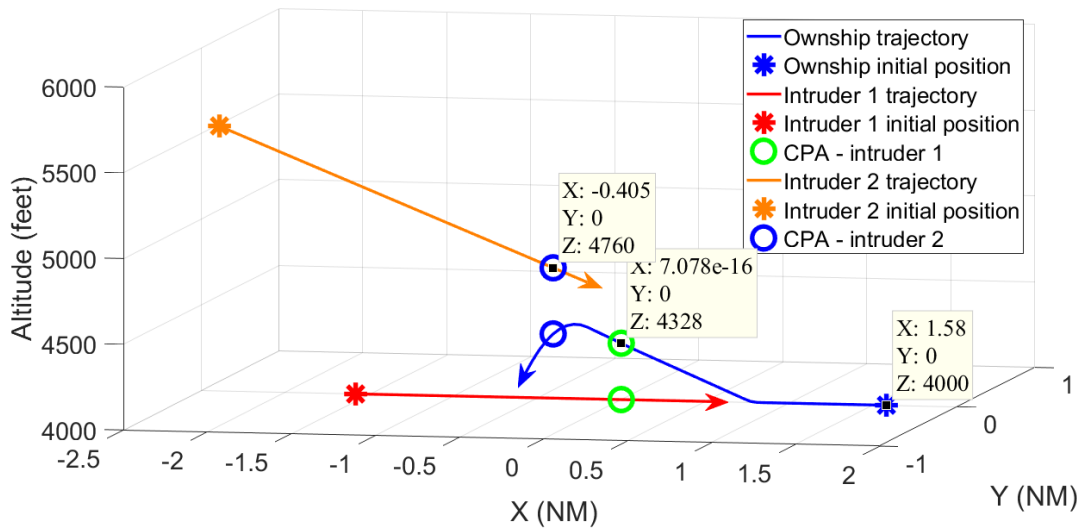

Figure 6.9: Trajectory simulation - multiple-threat encounter with an RA sense reversal case

that the collision avoidance logic is able to deal with a difficult encounter where the ALIM vertical separation cannot be kept, and the logic then has to choose a manoeuvre which keeps the vertical separation as large as possible. The parameters defining the scenarios are listed in Table 6.4, the scenarios vary in the amount of intruders and the altitude offset of Intruder 3.

Scenario 1 — A relatively simple encounter, only intruders 1-2 are present. The simulated trajectories are depicted in Figure 6.10.

Scenario 2 — A third intruder is added to the encounter. The altitude offset of Intruder 3 at the CPA is -400 feet, so that he collides with the evasive descent of the ownship used in Scenario 1. This scenario is depicted in Figure 6.11

Scenario 3 — The altitude offset of Intruder 3 is changed to -700 feet to precisely block the ownship from descending even at increased vertical rates as it did in Scenario 2. The resulting trajectories can be seen in Figure 6.12.

If we closely inspect the CPAs between intruders 1 and 2, we conclude that there is no possibility of flying between the first and the second intruder trajectories through the

CPAs without losing the ALIM vertical separation while the intruders are passing through the DMOD wide critical zone. That is because the horizontal distance between the CPAs is approximately 0.5 NM, while the critical area is 0.7 NM long (twice as long as the DMOD threshold), and the vertical distance between the CPAs is 520 feet which is lower than the height of the critical area (600 feet, twice the ALIM threshold). In Scenario 1, this leads to the RA reversal being necessary to maintain the level of protection.

Table 6.4: Values of Fixed Parameters - difficult multiple-threat encounter

	Ownship	Intruder 1	Intruder 2	Intruder 3
Approach angle α [°]	–	180	180	180
Horizontal Velocity [m/s]	100	100	100	100
ROCD [feet/min]	0	0	-1000	1000
Time Delay of CPA [s]	–	10	0	10
Altitude Offset [feet]	–	-100	420	variable
Sensitivity level	4			

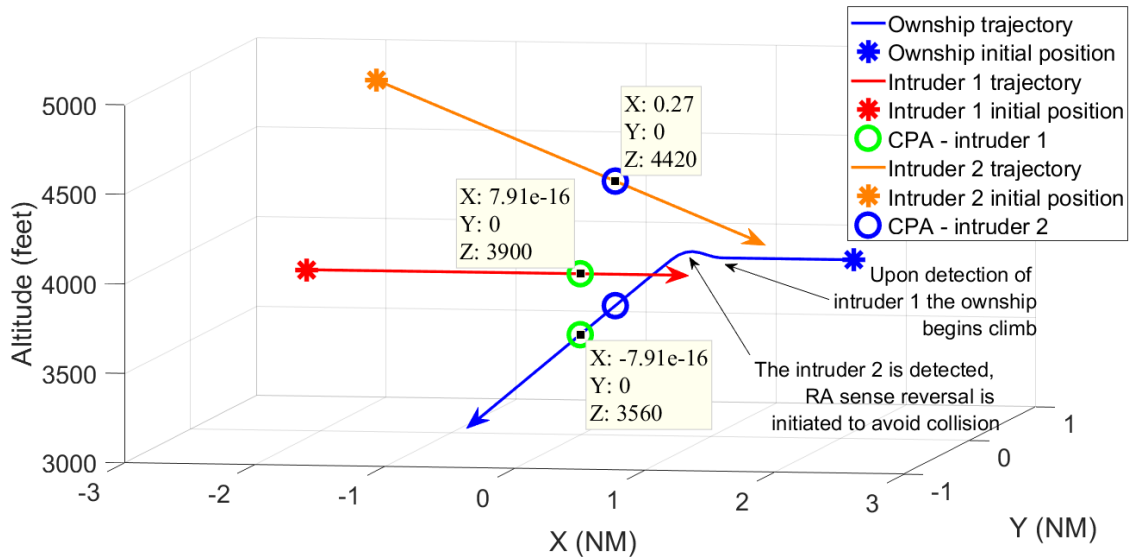

Figure 6.10: Multiple-threat encounter trajectory simulation - Scenario 1

In Scenario 2, the ownship detects the third intruder soon after the RA sense reversal. To avoid a collision, the ownship accelerates to a stronger descent and avoids the third intruder with a VMD of 395 feet.

In Scenario 3, the collision avoidance logic detects the third intruder after beginning the descent and performs a second RA sense reversal to achieve the largest vertical separation possible. It does so by climbing in-between the first and the second intruder. As discussed above, this route cannot provide the ALIM separation in the whole DMOD wide critical area around the ownship but it provides the largest possible vertical separation. The resulting vertical separation at the exact CPA is 350 feet with the first intruder, and 359 feet with the second intruder. The third intruder is almost 1000 feet below at the moment of the CPA. We can see that the collision avoidance logic chose a manoeuvre which keeps approximately the

same amount of vertical separation from both intruders. This approach maximizes the lowest of the vertical separations with the separate intruders.

To conclude, the collision avoidance logic works as expected. It performs well both in single and multiple-threat encounters. Integration with a more precise aircraft dynamics model, air traffic encounter model and a pilot response model should enable us to analyse the RA logic functionality accurately.

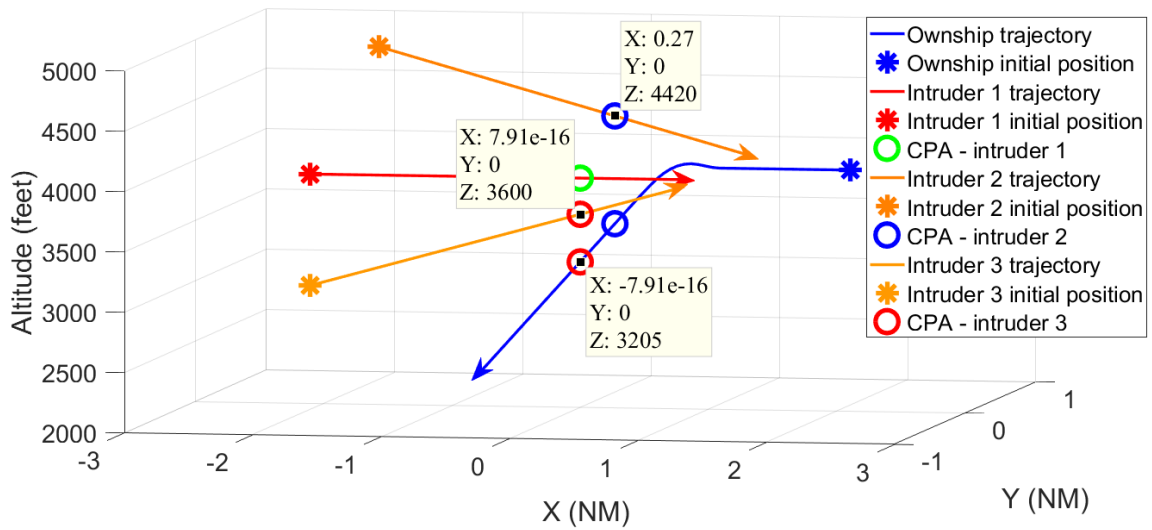

Figure 6.11: Multiple-threat encounter trajectory simulation - Scenario 2

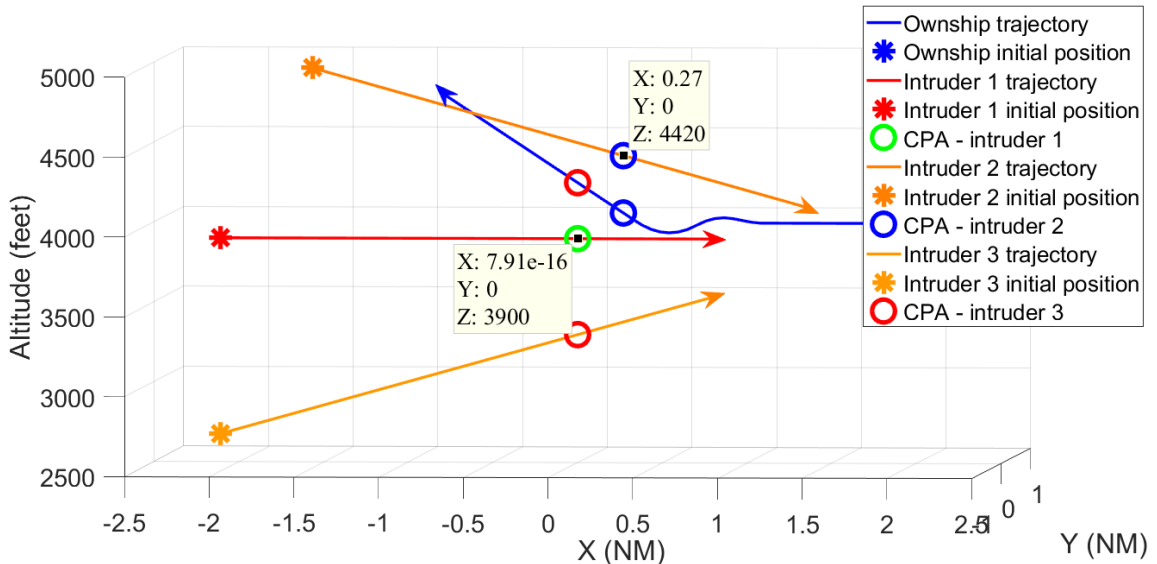

Figure 6.12: Multiple-threat encounter trajectory simulation - Scenario 3

Chapter 7

Collision Avoidance Logic Integration within the Air Traffic Simulation

For the purpose of a precise parametrised encounter simulation, the collision avoidance system was integrated within AgentFly air traffic simulation which was developed by researchers at AI Center, CTU in Prague. AgentFly simulates each aircraft as an independent autonomous entity responsible for planning its flight path and interacting with the rest of the system [3] (for samples of the AgentFly simulation visualisation see Figure 7.1). For our particular simulation BADA aircraft dynamics models (as described in Section 4.2.4) are used.

7.1 Entity Structure

The TCAS2 module is introduced as the main part of the entity representing the aircraft in our simulation of encounters. For the structure of the TCAS2 module see Figure 7.2. The entities communicate by sending/processing events which are distributed by the Distributed Events Manager. Entities can replan their current flight plan (e.g. upon detecting a future collision) by sending information about the desired future trajectories to the BADA Flight Planner in the form of clearances. A clearance mainly specifies the desired altitude at a particular point in the horizontal trajectory plan, and also an ROCD used to reach this altitude. The target altitude is specified in the form of FL which means that it is only possible to set the target altitude in a resolution of hundreds of feet. The position updates arrive once

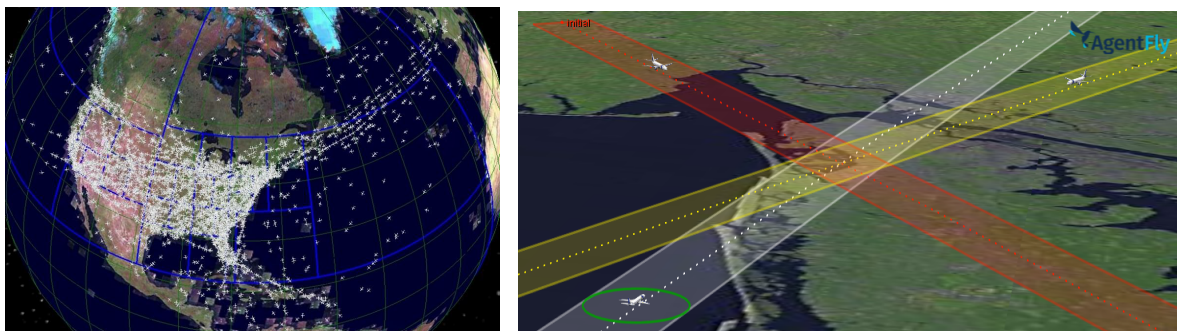

(a) Sample of AgentFly air traffic simulation (borrowed from [2])

(b) An example of a multiple-threat encounter with flight plans visualised

Figure 7.1: AgentFly simulation visualisation

per second which corresponds to the widely used Mode S transponder technology as described in Chapter 2.

7.1.1 TCAS2 Pilot Module

The TCAS2 module includes models for the RA logic composition, pilot response and coordination as can be seen in Figure 7.2. When the module receives a position update, it processes the data and sends it to the RA logic where the collision avoidance logic decides whether a change in plan is needed or not. If the former is the case, the issued RAs are sent to the pilot response model. The pilot response model stores past RAs, and it chooses when and how to react to the issued RAs by forwarding the chosen manoeuvre to the pilot control module. The manoeuvre is then converted into a suitable form of clearances for the BADA Flight Planner. The planner integrates the new clearances to the old flight plan and replans the future trajectories accordingly.

While active, the TCAS2 Pilot module broadcasts its identification to nearby aircraft via events. These events are received by other active modules with a specified delay. The active modules then keep a record of the identified active TCAS aircraft, so in the case of an encounter, they know TCAS-TCAS coordination can be engaged. When a threat with active TCAS is detected, the coordination process follows as explained in Section 3.3. The modules send their intents using the events, so that they can choose the complementary RA senses.

7.2 Encounter Simulation

Using the parametrisation of the encounters (introduced in Section 6.1), we can easily iterate over a single parameter and see its influence on the resulting characteristics. For an illustration of the encounter parameters see Figure 6.1a and Figure 6.1b.

The BADA performance model of the ATR 72¹, a twin-engined regional airliner, is used for the simulation of encounters in this chapter. The absolute horizontal velocity parameter is replaced by the aircraft's True Airspeed (TAS). The parameter of the ownship's altitude at the first CPA is derived from the desired altitude zone. It is set to the vertical centre of the desired zone to ensure the use of the zone's particular set of thresholds during the encounter. For the boundaries of zones and the corresponding threshold parameters see Table 3.1.

7.2.1 Single-threat Encounters

Results for three different altitude zones are always shown in this section to provide comparison and visualise the impact of the thresholds on various scenarios.

¹listed as AT72 in the BADA performance files

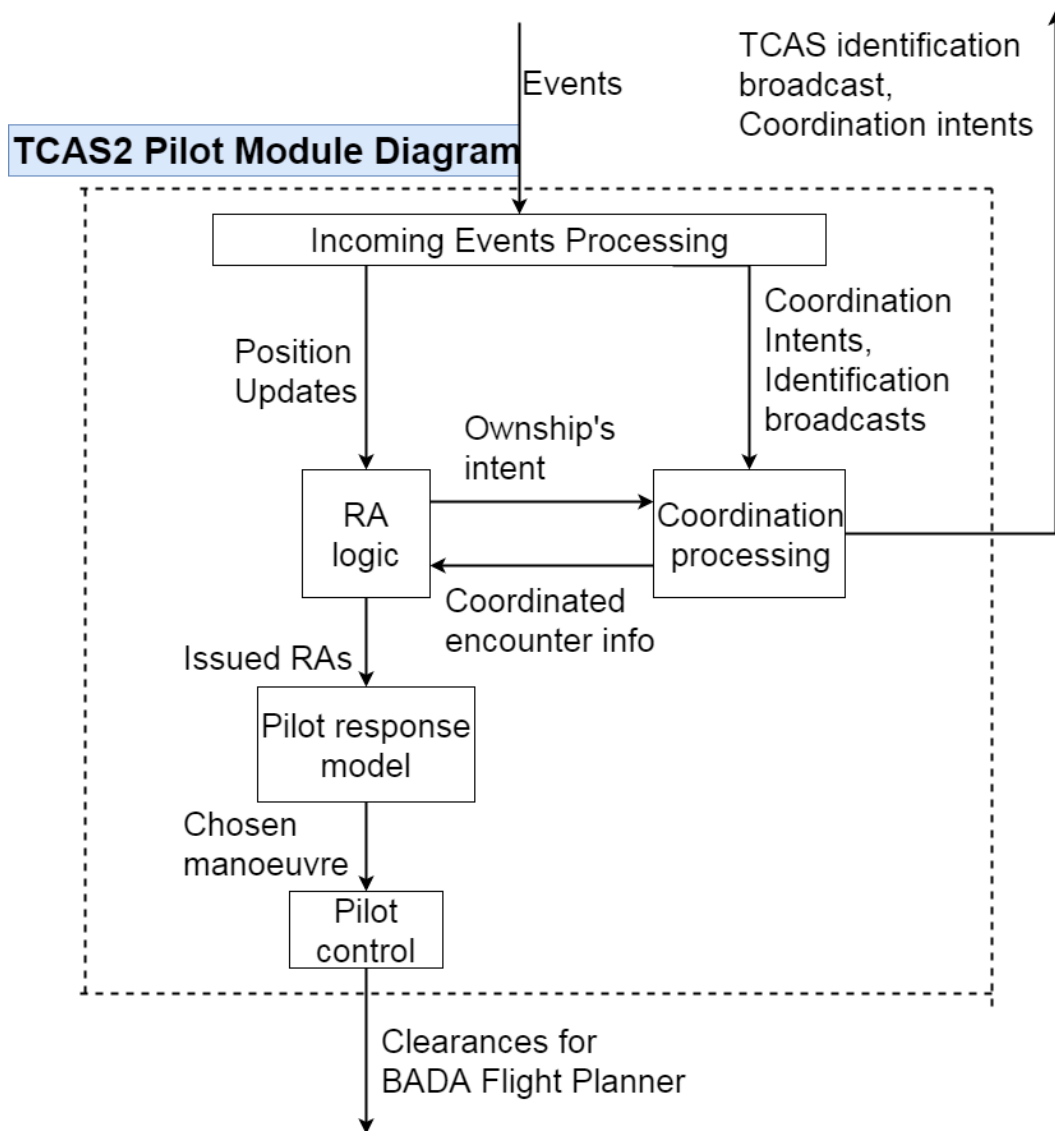

Figure 7.2: TCAS2 module structure diagram

The Effect of the Ownship's TAS

Figure 7.3 shows ALIM boundaries together with the resulting VMD for the range of TAS values, while other parameters are fixed (see Table 7.1). The resulting VMD stably stays slightly over the corresponding ALIM value except for the maximum TAS values. For those highest values of TAS the VMD slowly decays. This is caused by the aircraft dynamics model which has a limited maximum thrust for this given altitude.

Table 7.1: Values of Fixed Parameters - High Closure Rate impact on angle/reaction time characteristics

	Ownship	Intruder 1	Pilot Response Model Parameters	
α [°]	0	180	Initial Delay [s]	5.0
TAS [m/s]	variable	120	Consequent Delay [s]	2.5
ROCD [feet/min]	800	1200	RA age [s]	1.0
Zone	variable			

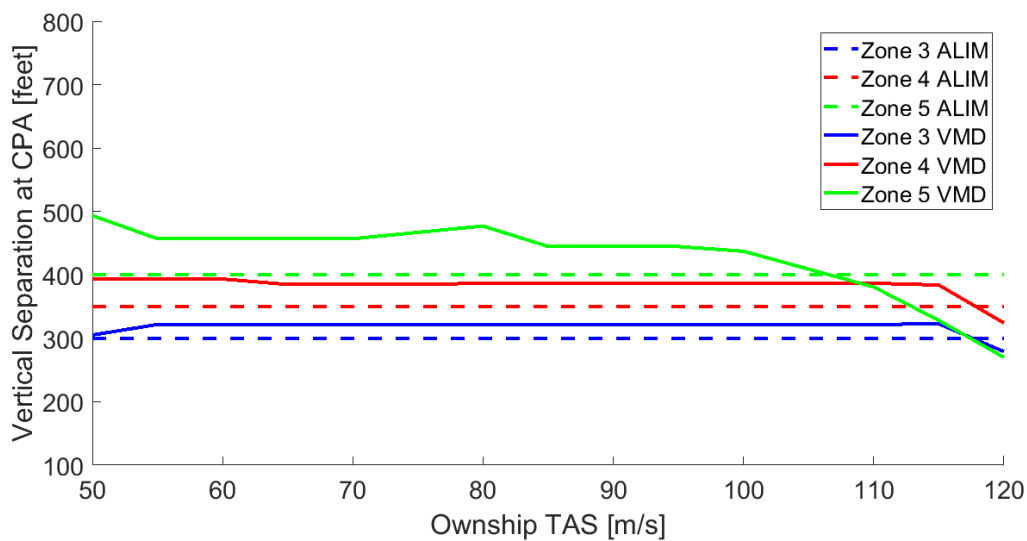

Figure 7.3: The resulting vertical separation at the CPA for different TAS values

The Effect of the Approach Angle α

Figure 7.4 and Figure 7.5 depict the impact of the approach angle α on the reaction time. The former does so for very high (horizontal) closure rates, the latter for very low closure rates. Full lists of the other parameters of the encounters are listed in Table 7.2 and Table 7.3, respectively. In both cases, the reaction time is higher for low values of α . This feature is considerably more significant in the low closure rates case. This is due to the shape of the RA detection area. For very low values of α the aircraft enter the DMOD-wide zone

much earlier which leads to an earlier issuance of an RA followed by an earlier reaction of the pilot model. In the high closure rates case, the reaction time for higher values of α quickly converges to the value of " $TAU - rd_{init}$ ". In contrast to the previous case, the reaction time in the low closure rate case is considerably higher, because the DMOD threshold is more significant in comparison to the closure rate.

Table 7.2: Values of Fixed Parameters - high closure rate's impact on angle/reaction time characteristics

	Ownship	Intruder 1	Pilot Response Model Parameters	
α [°]	0	variable	Initial Delay [s]	5.0
TAS [m/s]	120	120	Consequent Delay [s]	2.5
ROCD [feet/min]	800	1200	RA age [s]	1.0
Zone	variable			

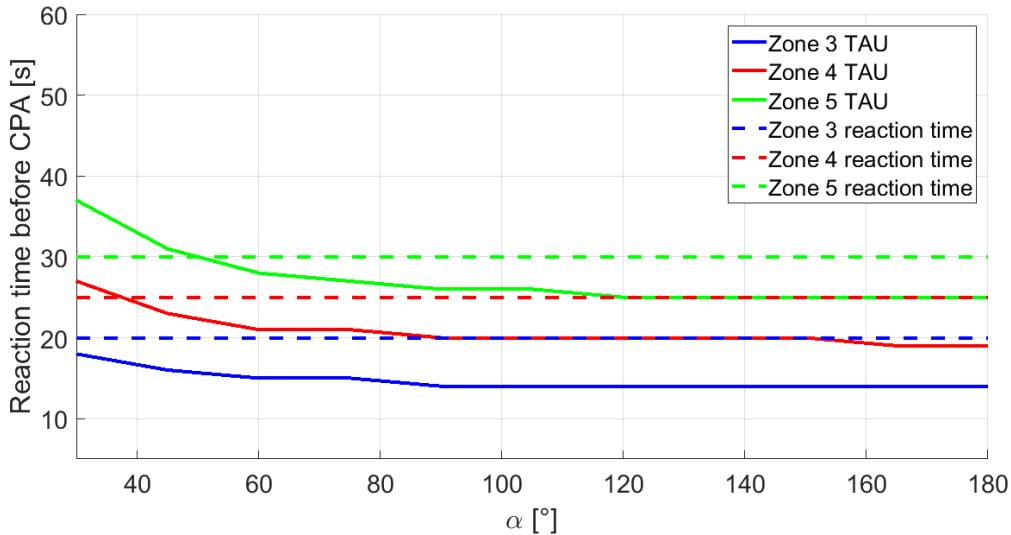

Figure 7.4: The impact of the α parameter on the reaction time for a high closure rate

Table 7.3: Values of Fixed Parameters - low closure rate's impact on α /reaction time characteristics

	Ownship	Intruder 1	Pilot Response Model Parameters	
α [°]	0	variable	Initial Delay [s]	5.0
TAS [m/s]	60	60	Consequent Delay [s]	2.5
ROCD [feet/min]	800	1200	RA age [s]	1.0
Zone	variable			

The Effect of the ROCD

Figure 7.6 shows the resulting VMD for a range of intruder's TAS values. The VMD for low ROCDs is slightly higher than the corresponding ALIM threshold, but it rises with the

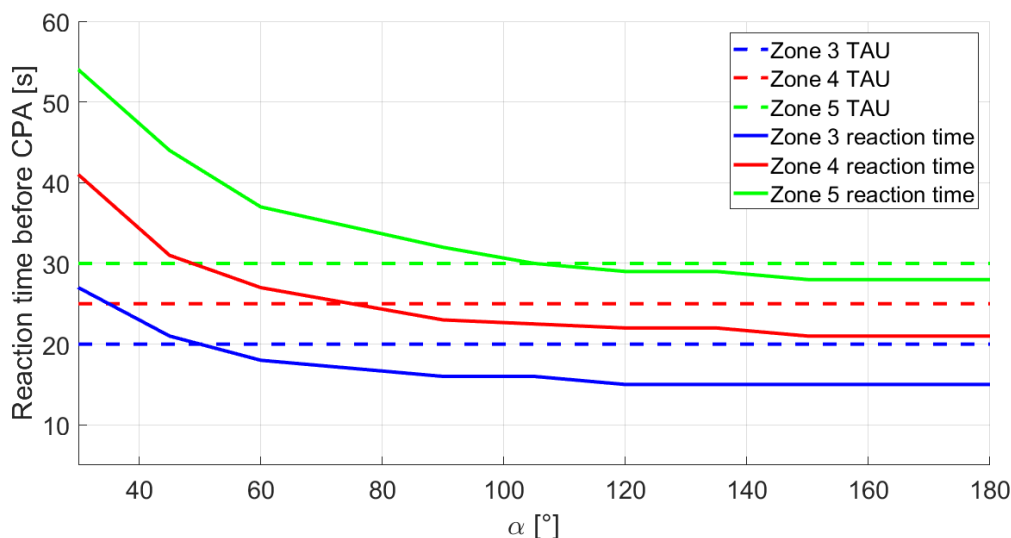

Figure 7.5: The impact of the α parameter on the reaction time for a low closure rate

rise of the intruder’s ROCD. As explained earlier in Section 6.2, as the relative ROCD rises, the vertical separation at the CPA rises too. This is the result of the aircraft gaining further vertical separation while the intruder flies through the DMOD-wide zone around the ownship. This feature is very significant in this particular case because the closure rate is low (both aircraft’s TAS is set to 60 m/s, there is an altitude offset of -100 to fix the upward RA sense for better comparison, for the rest of the parameters defining the encounter see Table 7.4). In Figure 7.6, the ROCD for Zone 5 is plotted only up to 2300 feet/min. This is due to a higher mid-zone altitude (FL 150) than in the case of zones 3-4 (FL 38, FL75), in which such a high ROCD is not reachable for the BADA aircraft model used (AT-72).

The VMD graphs tend to be jagged as can be seen at the beginning in Figure 7.6. This is because, as the encounter even slightly changes it is likely to cause the system to detect the intruder during the different position update which effectively leads to a different manoeuvre. All manoeuvres aim to provide at the least ALIM vertical separation throughout the DMOD-wide zone, and that can lead to quite different vertical separations at the exact CPA, especially when the pilot reaction delays are in effect. As mentioned in Section 7.1, the target altitude can be set with a resolution of hundreds of feet, this also causes the graphs to be jagged as the cruise altitude is rounded to hundreds of feet.

Table 7.4: Values of Fixed Parameters - Effect of Intruder’s ROCD

	Ownship	Intruder 1	Pilot Response Model Parameters	
α [°]	0	180	Initial Delay [s]	5.0
TAS [m/s]	60	60	Consequent Delay [s]	2.5
ROCD [feet/min]	0	variable	RA age [s]	1.0
Zone	variable			
Altitude offset [feet]	0	-100		

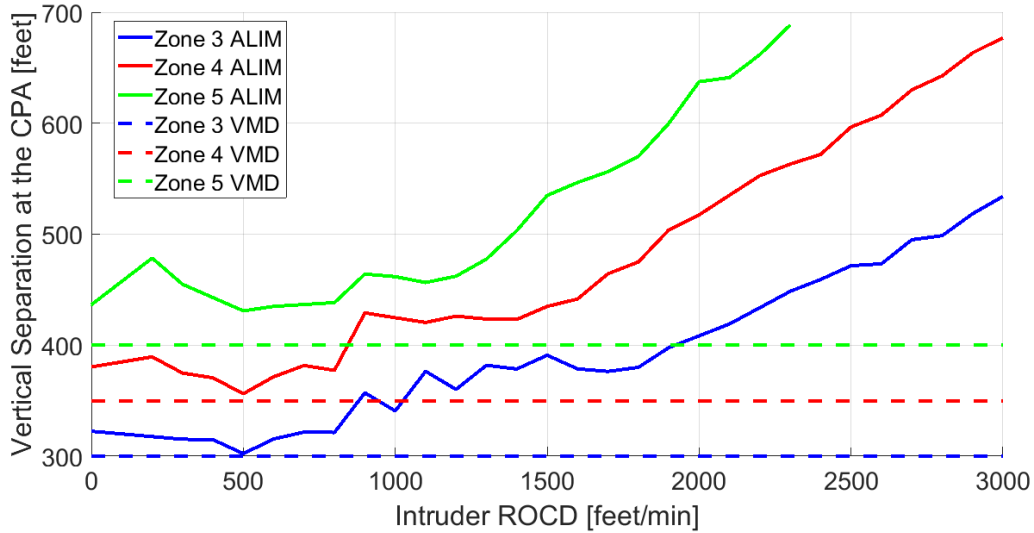

Figure 7.6: A rising ROCD impacting the VMD

The Effect of the Initial Pilot Response Delay

The impact of the rise of the initial pilot response delay on the VMD is depicted in Figure 7.7. Fixed parameters defining the encounter can be found in Table 7.5. TCAS assumes that the pilot reacts to the initial RA issuance with a 5 second delay [23]. Figure 7.7 shows that the VMD in this encounter is stable until the initial pilot response delay reaches 9 seconds for Zone 3, and 13 seconds for zones 4 and 5. This shows that the collision avoidance system is effective in such single-threat encounters until the delay reaches approximately twice the assumed amount. With a further rise of the delay, the VMD declines. With a delay of up to 16 seconds, the VMD drops to 100 feet which indicates the NMAC.

Table 7.5: Values of Fixed Parameters - Initial Pilot Response Delay impact on the VMD

	Ownship	Intruder 1	Pilot Response Model Parameters	
α [°]	0	180	Initial Delay [s]	variable
TAS [m/s]	110	60	Consequent Delay [s]	2.5
ROCD [feet/min]	0	1200	RA age [s]	1.0
Zone	variable			

Coordinated Encounters

In this section we test coordinated TCAS-TCAS encounters, for a description of coordinated encounters see Section 3.3. To show the benefits of coordination, we reuse the two encounters where the ALIM vertical separation was not kept in the uncoordinated encounters.

First, Figure 7.8 shows the VMD for the range of TAS values. Previously, as depicted

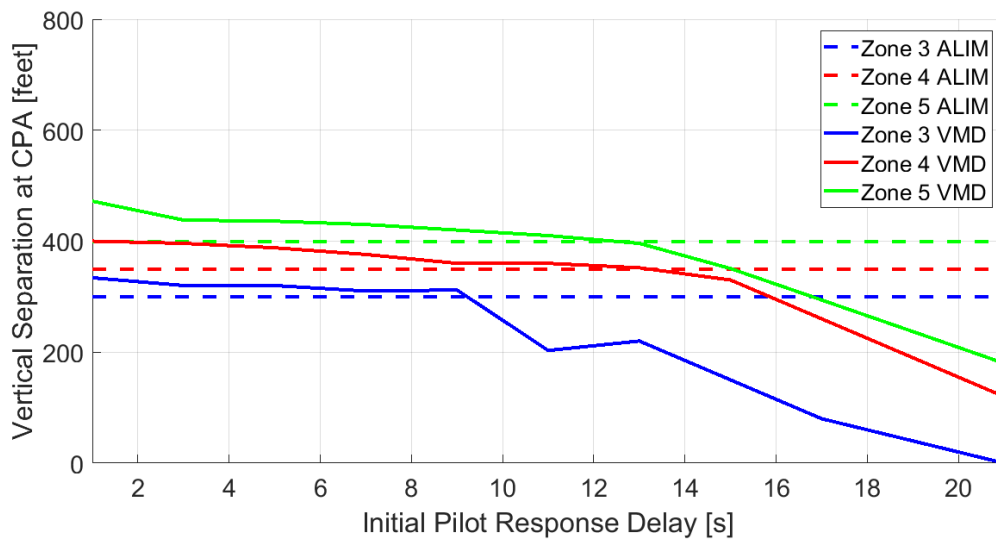

Figure 7.7: The impact of the initial pilot response delay on the resulting VMD

in Figure 7.3, the ALIM separation was violated because the ownship was not capable of a strong enough manoeuvre. In coordinated encounters, it is enough for both aircraft to perform weaker manoeuvres in opposite directions. As a result, the ALIM separation is kept as can be seen in Figure 7.8.

The ALIM separation was also not provided when the initial pilot response delay was too high as depicted in Figure 7.7. Results of the coordinated encounter simulation with the same set of parameters as in Table 7.5 are depicted in Figure 7.9. When compared with Figure 7.7, the decay of the vertical separation comes with approximately a 2 seconds higher value of delay than in the uncoordinated encounter case.

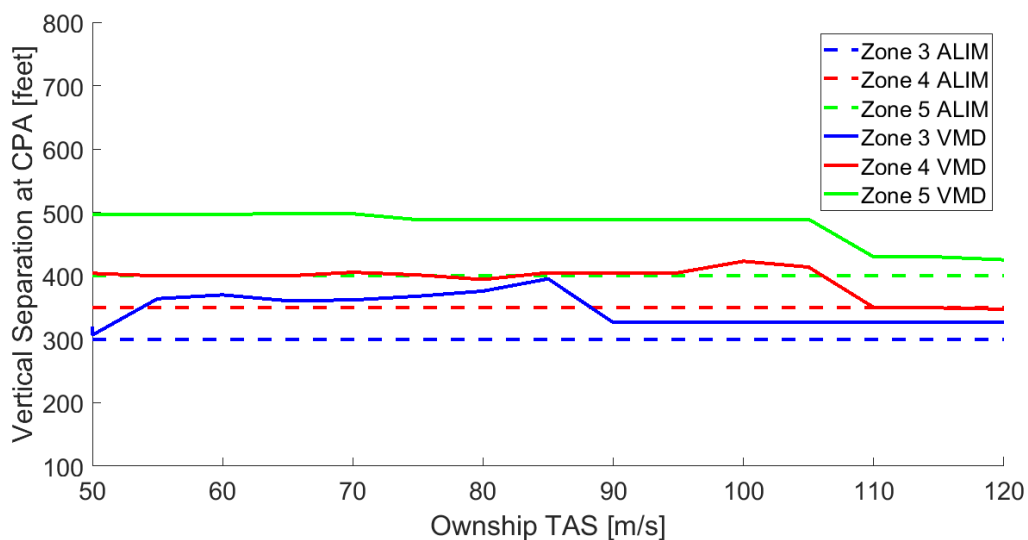

Figure 7.8: Coordinated version of the TAS iteration

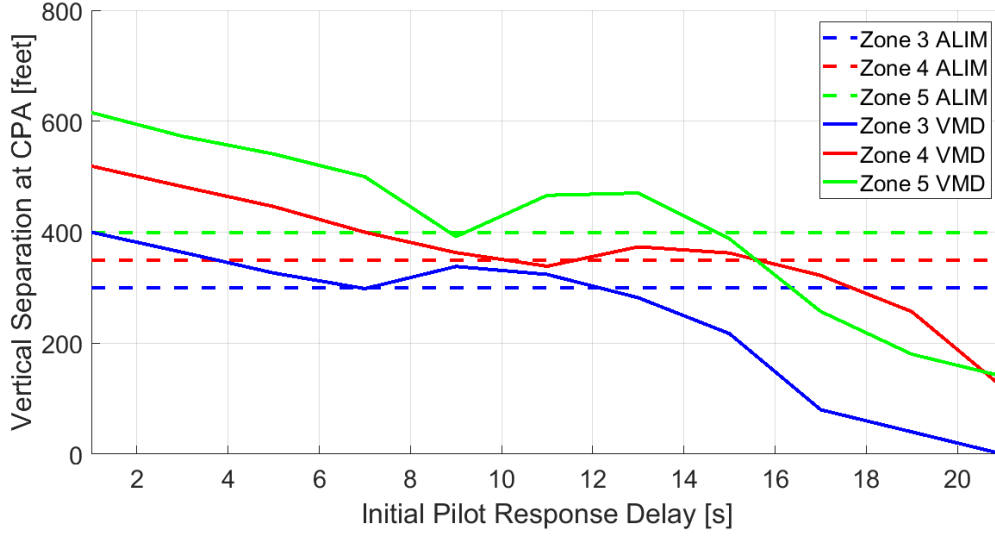

Figure 7.9: Coordinated version of the initial pilot response delay iteration

7.2.2 Multiple-threat Encounters

To test the effect of delays on multiple-threat encounters, we fix the ratios between pilot response parameters and iterate over them on sample encounters. The ratio that is kept is as follows:

$$rd_{cons} = \frac{1}{2}rd_{init} \quad (7.1)$$

$$ra_{age} = \frac{1}{5}rd_{init} \quad (7.2)$$

The following test scenarios are used to show the impact the simulation parameters have on the resulting VMD/delay characteristics:

Scenario 1 — Two intruders head from below and above to a direct collision with the ownship as specified by the parameters in Table 7.6. The results are depicted in Figure 7.10.

Scenario 2 — This scenario shows how the altitude offset parameter can influence the encounter. The offsets are set so that the prior ownship’s position at the CPA is surrounded by intruders with a vertical separation of 100 feet. The input parameters are specified in Table 7.7, and the characteristics is depicted in Figure 7.11. We also test coordinated version of this encounter where all aircraft are TCAS-equipped, this is depicted in Figure 7.12.

Scenario 3 — This scenario, defined by the parameters in Table 7.8 and visualised in Figure 7.13, shows the effect of a time offset between the intruders’ CPAs. The intruders’ CPAs do not coincide as in previous scenarios. Intruder 1 is delayed by 5 seconds.

The VMD graphs where we iterate over the response delays tend to be jagged because a small change in the delays is likely to cause the system to react to different position updates,

leading to issuing quite different manoeuvres etc. (this is also supported by the target altitude resolution as mentioned in Section 7.1).

Figure 7.10 shows that the VMD is stably above the ALIM threshold until the initial delay passes 10 seconds in Scenario 1. As shown in Figure 7.11, the ALIM vertical separation is harder to keep in Scenario 2 as the ownship has to manoeuvre further away (while crossing through the intruders' target altitudes at the CPA) to gain the same vertical separation as in Scenario 1. When the delay reaches 8 seconds, the system rather stays in-between the aircraft

Table 7.6: Values of Fixed Parameters - multiple-threat encounter - Scenario 1

	Ownship	Intruder 1	Intruder 2
α [°]	0	45	315
TAS [m/s]	60	60	60
ROCD [feet/min]	0	-700	700
Altitude offset [feet]	-	0	0
CPA time offset [s]	-	0	0
Zone	3		

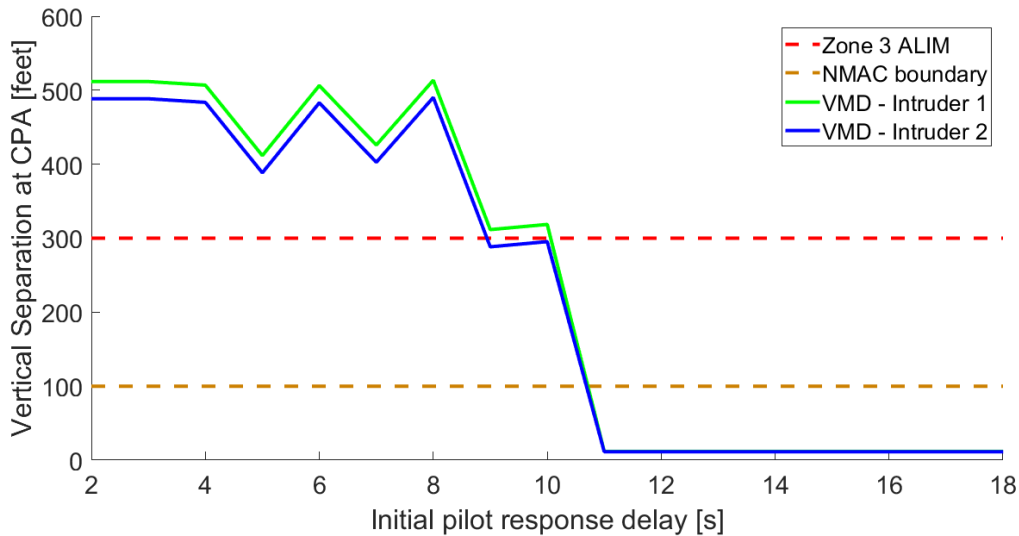

Figure 7.10: Multiple-threat encounter - Scenario 1

Table 7.7: Values of Fixed Parameters - multiple-threat encounter - Scenario 2

	Ownship	Intruder 1	Intruder 2
α [°]	0	45	315
TAS [m/s]	60	60	60
ROCD [feet/min]	0	-700	700
Altitude offset [feet]	0	100	-100
CPA time offset [s]	0	0	0
Zone	3		

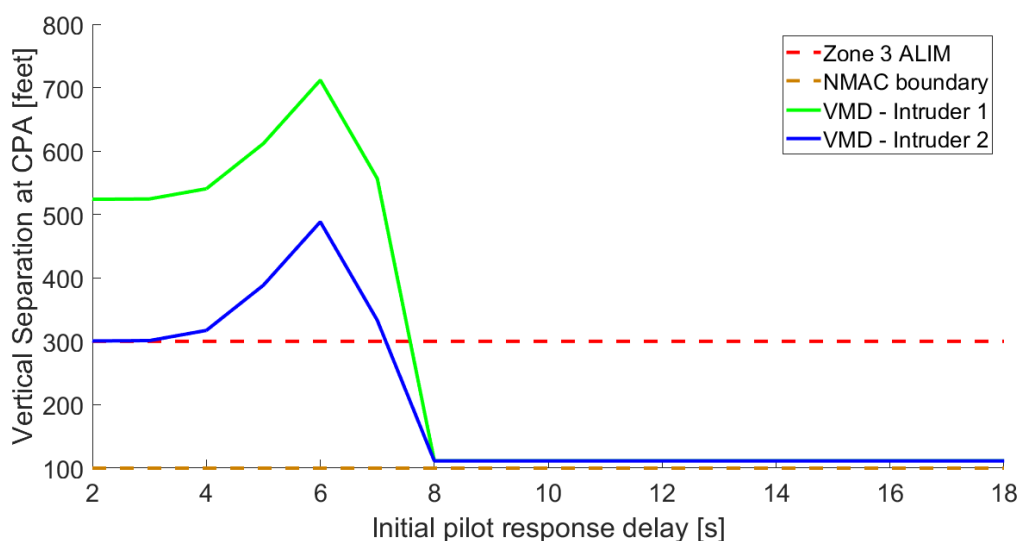

Figure 7.11: Multiple-threat encounter - Scenario 2

to have a separation of at least 100 feet as it does not have enough time to cross through the predicted intruders' altitudes. Of course this is an extreme case of two intruders who endanger the ownship at the exact same moment and the low sensitivity level causes the ownship to detect the intruder late. When the delay is around 6 seconds the VMD is highest because with a bigger initial delay a higher ROC_D is needed to provide ALIM at the beginning off the DMOD-wide zone around the ownship, and the rising consequent delay causes the ownship to level-off later than right after gaining the ALIM separation.

In Scenario 2 where the ownship is endangered both from above and below at the same time, it is difficult to avoid collisions by using vertical manoeuvres. But in a coordinated version of the encounter (Scenario 2) depicted in Figure 7.12, the aircraft cooperate to create a vertical separation and they are able to keep the vertical separation for much higher time delays. At very high values of delays (initial delay over 11 seconds etc.) the coordination begins to fail and the ALIM vertical separation cannot be provided.

In Scenario 3, the intruders' CPAs are separated by 5 seconds, the system is able to keep the ALIM separation for a similar range of the initial delay as in the single-threat encounter case. This is because, as the time offset between the intruders' CPAs rises, the ownship gains manoeuvring space.

7.3 Discussion of Results

The simulation in chapters 6-7 has shown the functionality of the collision avoidance system implementation based on TCAS RA logic. The system's ability to prevent collisions by providing sufficient vertical separation was shown in various scenarios. The simulation using the BADA aircraft dynamics model has shown certain limitations of the system. For high horizontal velocities, especially in high altitude zones, the maximum thrust limits the aircraft's

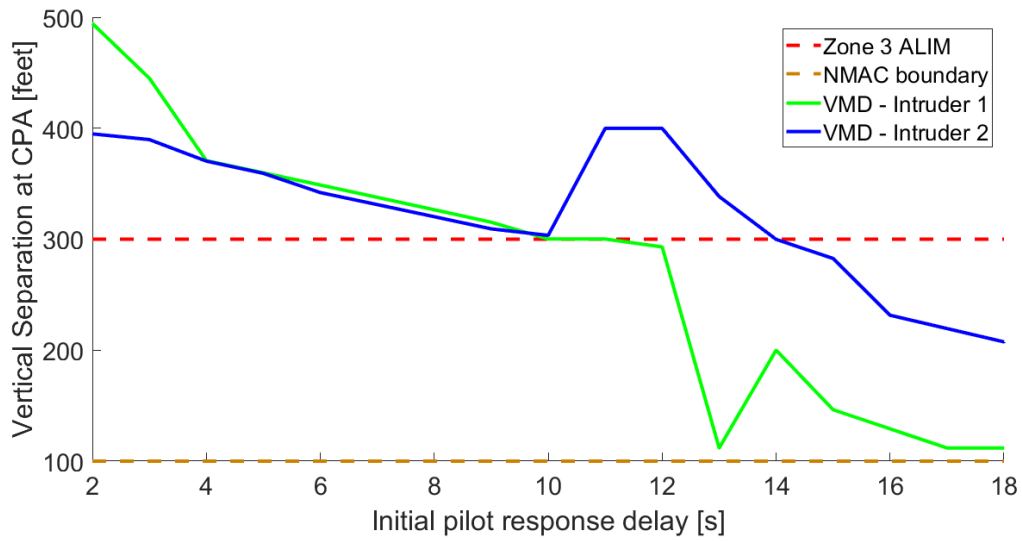

Figure 7.12: Multiple-threat encounter - Scenario 2 - coordinated version

Table 7.8: Values of Fixed Parameters - Scenario 3

	Ownship	Intruder 1	Intruder 2
α [°]	0	90	270
TAS [m/s]	60	60	60
ROCD [feet/min]	0	-700	700
Altitude offset [feet]	0	100	-100
CPA time offset [s]	0	5	0
Zone	3		

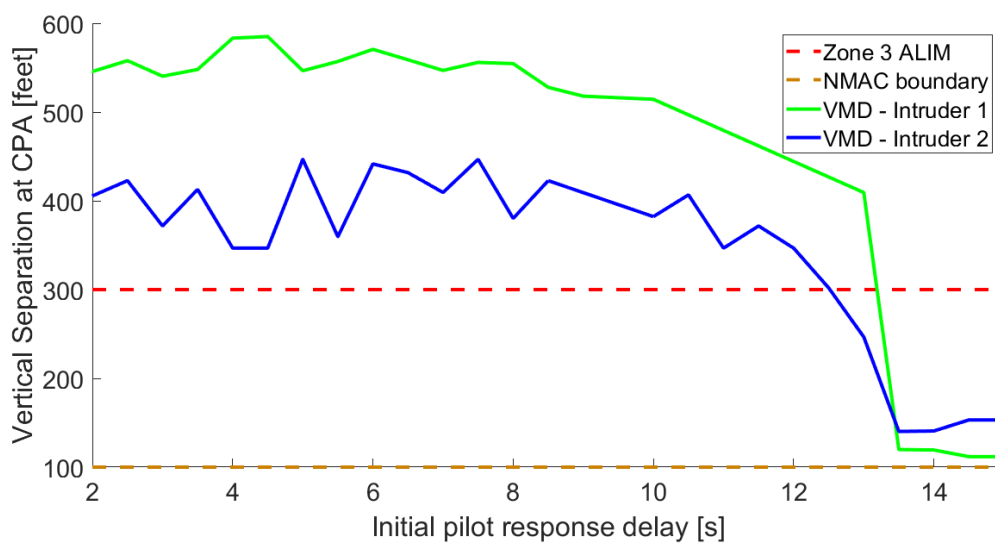

Figure 7.13: Multiple-threat encounter - Scenario 3

capability to do vertical manoeuvres. This results in weaker manoeuvres than requested by the collision avoidance system, leading to a lower VMD being reached (shown in Section 7.2.1). The collision avoidance system has no mechanism to predict the aircraft's incapability to perform a vertical manoeuvre under conditions like combined high altitude and TAS. TCAS is restricted to the aircraft which achieve specific general performance criteria like the minimum ROCD [17]. Planned future versions of collision avoidance systems like ACAS X intend to involve different performance criteria of different classes of aircraft in their design [17]. This is to enable the system to be used on a variety of aircraft without general performance restrictions. Using the BADA aircraft dynamics models, the encounter simulation shows that the collision avoidance system would also benefit from a dynamic evaluation of aircraft's manoeuvring capabilities (e.g. based on the current velocity and altitude) which could be done based on BADA performance files, for example.

The pilot response model was used to inspect how the delays affect the system's functionality. In single-threat encounters, a high initial pilot response delay led to a decrease in the resulting VMD as depicted in Figure 7.7. Until the delay reached approximately double the value assumed by TCAS, the VMD remained stably above the ALIM threshold. Testing a coordinated version of the same encounters showed that the coordination allows for a slightly higher value of delay (+2 seconds) while retaining the ALIM vertical separation (pictured in Figure 7.9). In multiple-threat encounters, we modified parameters defining the scenarios to show their impact on the delay/VMD characteristic. It appears that the most difficult encounters occur when there are multiple threats whose CPAs coincide. In such a scenario with threats both from above and below and offsets set to surround the ownship's altitude, the system failed to provide the ALIM separation with just slightly higher delays (an initial pilot response delay of 8 seconds and etc., for details see Section 7.2.2) than the default values that TCAS assumes. The coordination has shown to be very effective in dealing with such encounters. While cooperating the aircraft managed to avoid losing the ALIM separation for larger delay range (up to 12 seconds of initial pilot response delay etc., for details see Section 7.2.2). For even higher delays the VMD becomes unstable and the coordination is ineffective as depicted in Figure 7.12. With just a few seconds delay between the intruders' CPAs, the system manages the encounter with a range of delays comparable to the single-threat encounters as depicted in Figure 7.13. Overall, the delays show a significant impact on the system's ability to avoid collisions. A collision avoidance system based on TCAS logic for UAVs would benefit from the small reaction delays the autonomous pilot can provide. For single-threat encounters and less difficult multiple-threat encounters the delays can rise to almost double the assumed value before the system stops stably providing the ALIM vertical separation. There is a slightly higher reserve for coordinated encounters. But in difficult uncoordinated multiple-threat encounters just a slightly higher delay may cause loss of the ALIM separation.

Chapter 8

Conclusion

The aim of this thesis was to analyse the functionality of TCAS. First, we presented the principles of operation of on-board transponders and TCAS. Next, we discussed the methodology used for the verification of the collision avoidance systems functionality, focusing on the method of computational simulation analysis using the models of collision avoidance logic, encounters, aircraft dynamics, pilot response and air traffic. Then, we implemented a collision avoidance system based on the TCAS functionality. We verified the functionality of the subsystems of the collision avoidance logic by visualising and analysing the area where the threats are detected, and a certain type of manoeuvre is required. We introduced a parametrised encounter model suitable for our analysis. As a whole, the collision avoidance logic implementation was then verified in various single and multiple-threat encounters using a discrete encounter simulation with a point-mass aircraft dynamics model. Finally, we integrated the collision avoidance logic and a parametrised model of the pilot response into an air traffic simulation using the precise BADA aircraft dynamics models. We analysed the impact of encounter defining parameters on the collision avoidance logic's functionality and estimated delay-related limitations of the system's functionality.

Bibliography

- [1] Federal Aviation Administration. Equip ADS-B - capabilities - ins and outs. https://www.faa.gov/nextgen/equipadsb/capabilities/ins_outs/ last visited on 24.3.2018.
- [2] AgentFly, AI Center, CTU in Prague. ATM simulation of Air Traffic and ATCO Behavior.
- [3] AI Center, CTU in Prague. AgentFly-Related Projects. <http://agents.felk.cvut.cz/projects/agentfly/> last visited on 19.4.2018.
- [4] International Civil Aviation Organization Asia and Pacific Office. ADS-B implementation and operations guidance document, edition 7.0, 2014.
- [5] T.B. Billingsley. *Safety Analysis of TCAS on Global Hawk Using Airspace Encounter Models*. Massachusetts Institute of Technology, Department of Aeronautics and Astronautics, 2006.
- [6] The European Commission. Commission implementing regulation (EU) No 1207, 2011.
- [7] EUROCONTROL. ACAS II. <http://www.eurocontrol.int/acas> last visited on 11.4.2018.
- [8] EUROCONTROL. BADA factsheet. September 2015.
- [9] EUROCONTROL. Mode S Operational Overview. <http://www.eurocontrol.int/articles/mode-s-operational-overview> last visited on 23.4.2018.
- [10] EUROCONTROL. TCAS II protection Volume. https://commons.wikimedia.org/wiki/File:TCAS_Volume.jpg last visited on 5.4.2018.
- [11] EUROCONTROL. ACAS Guide Airborne Collision Avoidance, December 2017.
- [12] Mykel J Kochenderfer, Leo P Espindle, James K Kuchar, and J Daniel Griffith. A comprehensive aircraft encounter model of the national airspace system. *Lincoln Laboratory Journal*, 17(2):41–53, 2008.
- [13] Mykel J Kochenderfer, Matthew W M. Edwards, Leo P Espindle, James K Kuchar, and J Daniel Griffith. Airspace encounter models for estimating collision risk. *Journal of Guidance, Control, and Dynamics*, 33(2):487–499, 2010.
- [14] J Kuchar. Evaluation of Proposed Changes to the ACAS Modified Tau Calculation. 2006.
- [15] César Muñoz, Anthony Narkawicz, and James Chamberlain. A TCAS-II resolution advisory detection algorithm. In *AIAA Guidance, Navigation, and Control (GNC) Conference*, page 4622, 2013.

BIBLIOGRAPHY

- [16] Murfreesboro Aviation. ADS-B. <https://murfreesboroaviation.com/2016/03/no-bs-pdq-abcs-ads-b/> last visited on 24.3.2018.
- [17] EUROCONTROL NETALERT. N17 - ACAS X - the future of airborne collision avoidance, June 2013.
- [18] A Nuic. User manual for the base of aircraft data (bada) revision 3.10. *Atmosphere*, 2010:001, 2010.
- [19] U.S. Department of Transportation Federal Aviation Administration. Advisory Circular Airworthiness Approval of Traffic Alert And Collision Avoidance Systems (TCAS II), Versions 7.0 & 7.1 and Associated Mode S Transponders , 2009.
- [20] International Civil Aviation Organization. ADSB Guide Vs1.2 English, 2013.
- [21] SKYbrary, EUROCONTROL. ACAS. [https://www.skybrary.aero/index.php/Airborne_Collision_Avoidance_System_\(ACAS\)](https://www.skybrary.aero/index.php/Airborne_Collision_Avoidance_System_(ACAS)) last visited on 24.3.2018.
- [22] SKYbrary, EUROCONTROL. Transponder. <https://www.skybrary.aero/index.php/Transponder> last visited on 24.3.2018.
- [23] Federal Aviation Administration U.S. Department of Transportation. Introduction to TCAS II, Version 7.1, 2011.

CD Contents

The names of all the root directories on the CD are listed in Table 1.

Directory name	Description
thesis	the thesis in PDF format
thesis_sources	LaTeX source codes
source	Java source codes

Table 1: CD Contents

List and Meaning of Abbreviations

The abbreviations used in this thesis are listed in Table 2.

Abbreviation	Meaning
ADS-B	Automatic Dependent Surveillance - Broadcast
ALIM	ALtitude LIMit
BADA	Base of Aircraft DATA
CD2D	Conflict Detection 2-Dimensional algorithm
CPA	Closest Point of Approach
DMOD	Distance MODified
FAA	Federal Aviation Administration
GNSS	Global Navigation Satellite System
HMD	Horizontal Miss Distance
ICAO	International Civil Aviation Organization
NMAC	Near Mid-Air Collision
RA	Resolution Advisory
TA	Traffic Advisory
TAS	True AirSpeed
TCAS	Traffic Collision Avoidance System
TIS-B	Traffic Information Service - Broadcast
ROCD	Rate of Climb/Descend
VMD	Vertical Miss Distance
ZTHR	Z- THReshold (vertical threshold for advisories)

Table 2: Lists of abbreviations