

OWNER'S HANDBOOK

DS5 Hybrid4



CITROËN

MyCITROËN

On-line owner's handbook

You can find your handbook on the CITROËN website, under "MyCitröen".

This personal and customisable space allows you to establish direct and special contact with CITROËN.

Referring to the owner's handbook on-line also gives you access to the latest information available, easily identified by the bookmark, associated with this symbol:



If the "MyCitröen" function is not available on the CITROËN public website for your country, you can find your handbook at the following address:

<http://service.citroen.com>

Select:

- > The Vehicle documentation link in the home page (no registration is needed),
- > the language,
- > the vehicle, its body style,
- > the print edition of your handbook appropriate for the date of registration of your vehicle.

You have access to your handbook on line, together with the latest information, identified by the symbol:



We draw your attention to the following...

Your vehicle is fitted with only some of the equipment described in this document, depending on the trim level, version and the specifications for the country in which it is sold.

The fitting of electrical equipment or accessories which are not recommended by CITROËN may result in a failure of your vehicle's electronic system. Please note this specific warning and contact a CITROËN dealer to be shown the recommended equipment and accessories.





CITROËN has a presence on every continent, a complete product range, bringing together technology and a permanent spirit of innovation, for a modern and creative approach to mobility. We thank you and congratulate you on your choice.

At the wheel of your new vehicle, getting to know each system, each control, each setting, makes your trips, your journeys more comfortable and more enjoyable.

Happy motoring!

Contents

Key

-  safety warning
-  additional information
-  contributes to the protection of the environment
-  programming a function with the configuration menu
-  refer to the page indicated

6 FAMILIARISATION

348 ALPHABETICAL INDEX

353 VISUAL SEARCH



HYBRID SYSTEM

- 28 Presentation
- 31 Starting / switching off
- 35 Ready lamp
- 35 Hybrid4 mode selector
- 38 Energy consumption / generation indicator
- 40 Display of hybrid power flow
- 43 Hybrid4 frequently asked questions
- 46 Eco off
- 47 Eco-driving
- 49 Consumption
- 50 High voltage battery
- 54 Car washing machine or tunnel
- 55 Vehicle recovery



001 MONITORING

- 58 Instrument panel
- 59 Indicator and warning lamps
- 68 Gauges and indicators
- 72 Adjustment buttons
- 74 Setting the date and time
- 74 Clock
- 76 Trip computer



002 ACCESS

- 80 Electronic key - remote control
- 81 "Keyless Entry and Starting"
- 88 Boot
- 89 Alarm
- 91 Electric windows
- 93 Cockpit glass roof
- 95 Fuel tank
- 96 Misfuel prevention (Diesel)

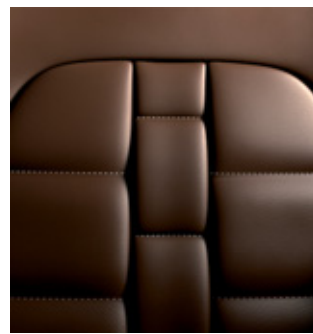

003 COMFORT

- 100 Front seats
- 105 Rear seats
- 108 Mirrors
- 109 Steering wheel adjustment
- 110 Interior fittings
- 114 Boot fittings
- 115 Triangle (stowing)
- 116 Heating and Ventilation
- 118 Dual-zone digital air conditioning
- 122 Rear screen demist - defrost



004 DRIVING

- 126 Electric parking brake
- 134 Hill start assist
- 135 6-speed electronic gearbox
- 139 Lane departure warning system
- 140 Head-up display
- 143 Speed limiter
- 145 Cruise control
- 147 Parking sensors
- 149 Reversing camera



005 VISIBILITY

- 152 Lighting controls
- 155 Daytime running lamps
- 156 Automatic illumination of headlamps
- 157 Automatic headlamp dipping
- 160 Headlamp adjustment
- 161 Directional lighting
- 163 Wiper controls
- 165 Automatic rain sensitive wipers
- 167 Courtesy lamps
- 168 Interior mood lighting

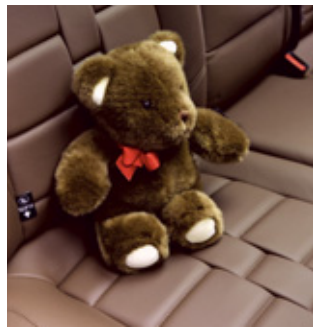

006 CHILD SAFETY

- 172 Child seats
- 178 ISOFIX child seats
- 181 Child lock



007 SAFETY

- 184 Direction indicators
- 185 Emergency or assistance call
- 185 Horn
- 186 Tyre under-inflation detection
- 187 ESC system
- 190 Seat belts
- 193 Airbags



003 PRACTICAL INFORMATION

- 200 Temporary puncture repair kit
- 206 Changing a wheel
- 213 Snow chains
- 214 Changing a bulb
- 222 Changing a fuse
- 225 12 V battery
- 228 Energy economy mode
- 229 Changing a wiper blade
- 229 Recovering the vehicle
- 231 Vehicle recovery
- 231 Towing a trailer
- 233 Fitting roof bars
- 234 Accessories



009 CHECKS

- 239 Opening the bonnet
- 240 Diesel engine
- 241 Running out of fuel (Diesel)
- 242 Checking levels
- 245 Checks



010 TECHNICAL DATA

- 250 Electric motor
- 251 Diesel engine
- 252 Diesel weights
- 253 Dimensions
- 254 Identification markings



011 AUDIO AND TELEMATICS

- 258 Emergency or assistance
- 261 eMyWay
- 315 Audio system

Familiarisation

Familiarisation

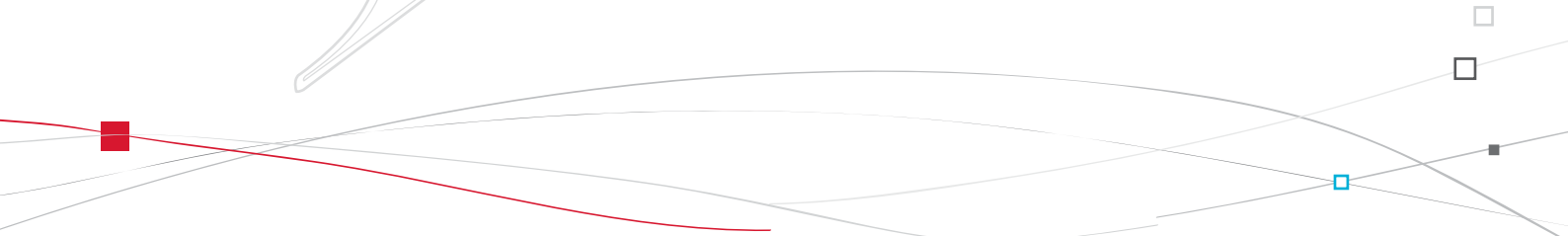



Presentation of the Hybrid4 system

Thank you for choosing a DS5 Hybrid4; this vehicle has characteristics that are different from conventional vehicles.

Study this handbook to learn about the specific hybrid functions and for more information, refer to the "Hybrid system" section.

▶ 26

The Hybrid4 technology allows two sources of energy to be associated in an effective manner: the Diesel HDi engine, which drives the front wheels and the electric motor, which drives the rear wheels.

These two motors can operate alternately or simultaneously, according to the hybrid mode selected and the driving conditions.

The electric motor alone provides power for the vehicle in "ZEV" (Zero Emissions Vehicle) mode, and in "Auto" mode for running at slow speed and low load. It also assists the Diesel engine when moving off, accelerating and changing gear.

The battery that powers the electric motor is recharged during phases of deceleration and stores the energy for subsequent use.

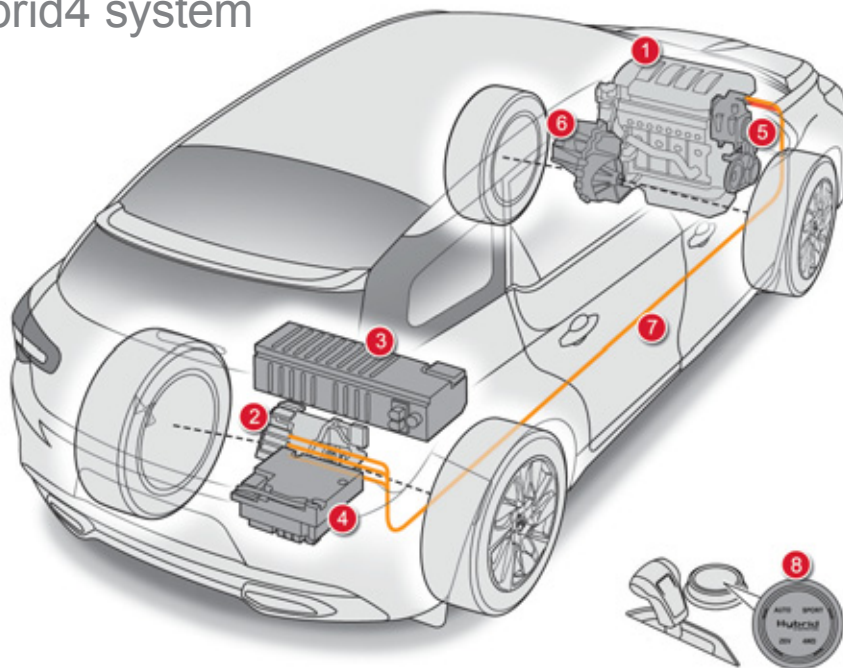

1. Diesel HDi engine (front wheel drive).
2. Electric motor (rear wheel drive).
3. 200 V battery.
4. Electronic power supervisor.
5. Stop & Start system.
6. 6-speed electronic gearbox.
7. Electrical flow.
8. Hybrid4 mode selector.

For economical driving, caring for the environment

The fuel **consumption** of a vehicle **varies greatly**:

- according to the driver's **style of driving** (moderate, aggressive, fast, ...),
- according to the **type of journeys** made (urban, main road, motorway, flowing, heavy traffic, ...) and the speed.

Main recommendations for driving economically

Hybrid mode selector

To optimise fuel consumption, use the **Auto mode** of the selector whenever possible (the mode is activated automatically when starting) including for urban journeys.

This mode optimises the use of the energy sources (internal combustion engine and/or electric) contrary to other modes, which are for use in particular cases.

Gear lever

Use the **automatic mode A** as much as possible as this optimises gear changes to suit the requirements.

Drive smoothly

Stay in the "eco" zone displayed in the energy consumption / generation indicator: accelerate gently, drive at steady speeds using the speed limiter or cruise control as soon as possible.

Use the "charge" zone: anticipate the need to slow down by taking your foot off the accelerator rather than braking.

The movement of the energy consumption / generation indicator needle (into the "charge" zone), shows the level of energy recovery.

Consumption history

See the impact of your style of driving and the type of journey by reviewing the history of your energy consumption. Refer to the "Multifunction screens" section.

Causes of high consumption and checks

As with any vehicle, limit overloading, wind resistance (windows open above 30 mph (50 km/h), roof bars, loaded or not, ...), the use of power consumers (air conditioning, heated seats, heated rear screen, ...).

Observe the recommendations on checks (regular check of tyre pressures, correct tyre pressures, ...) and routine servicing.

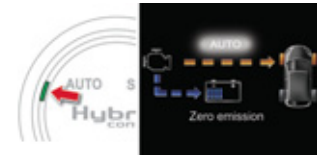

Exterior

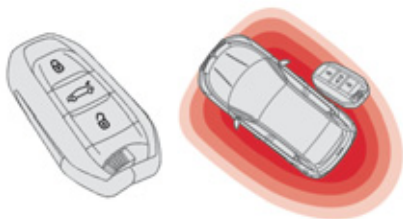

Electronic key: Keyless Entry and Starting

This system allows you to unlock, lock and start your vehicle while keeping the key on your person and in the defined zone around the vehicle.

▶ 81

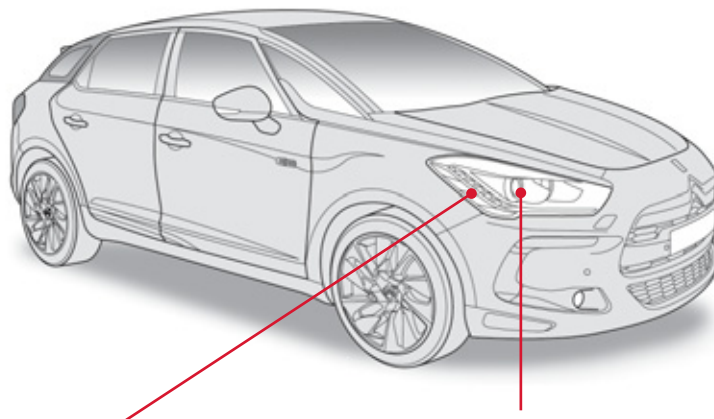

Daytime running lamps

This lighting, switched on automatically when starting the engine, makes your vehicle more visible to other road users.

▶ 155

Directional lighting

This lighting automatically provides additional forward visibility when cornering.

▶ 161

Exterior

Automatic headlamp dipping

This system automatically changes between dipped and main beam, depending on the driving conditions, using a camera located in the interior rear view mirror.

▶ 157

Reversing camera

This system, available only with satellite navigation, is activated automatically on engaging reverse gear and provides an image in the colour screen.

▶ 149



Temporary puncture repair kit

This kit is a complete system consisting of a compressor and a sealant cartridge, to allow the temporary repair of a tyre.

▶ 200

Front and rear parking sensors

This systems warns you of the presence of obstacles located in front of or behind the vehicle during parking manoeuvres.

▶ 147

Access

Electronic key

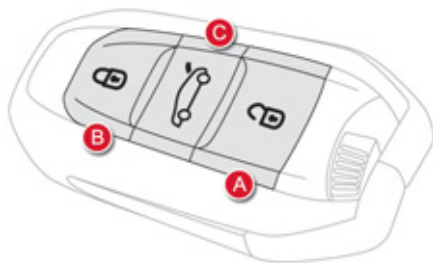

- A. Unlocking the vehicle.
- B. Normal locking of the vehicle
- C. Unlocking the boot and complete unlocking of the vehicle.

▶ 80

Keyless Entry and Starting

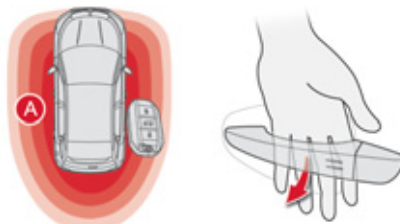

Unlocking

With the electronic key on your person and in the defined zone **A** around the vehicle, pass your hand behind the door handle to unlock the vehicle, then pull on the handle to open the door.

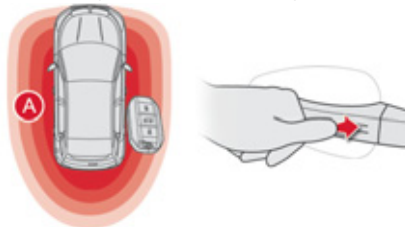

Locking

With the electronic key in the defined zone **A** around the vehicle, press with a finger on the door handle (at the markings) to lock the vehicle.

▶ 81

Fuel tank



1. Opening the fuel filler flap.
Tank capacity: approximately 60 litres.

▶ 95

Boot



1. Unlocking the boot from inside: maintain pressure until the boot is heard to unlock.

▶ 88

Interior

Audio and communication systems

These systems benefit from the latest technology: MP3 compatible audio systems, USB player, Bluetooth hands-free system, satellite navigation system with colour screen, auxiliary inputs, Hi-Fi audio system, ...

eMyWay

▶ 261

Audio system

▶ 315

Central storage containing various systems

It is illuminated, cooled and provides storage and locations for systems and loose items (USB Player, location for a bottle, ...).

▶ 112

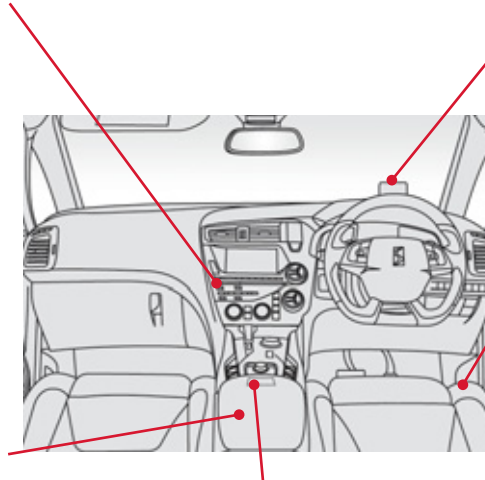

Electric parking brake

It combines the functions of automatic application on switching off the engine and automatic release when moving off. Manual application and release remains possible.

▶ 126

Head-up display

This system projects speed and cruise control/speed limiter information onto a smoked strip in the driver's field of vision, so that they do not need to take their eyes off the road.

▶ 140

Massage function







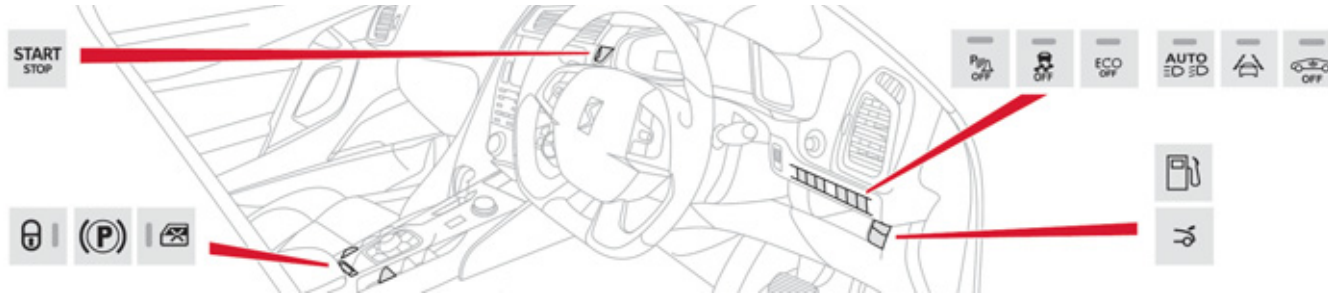





This system provides a lumbar massage for a period of about 60 minutes. The massage is done in 6 cycles of 10 minutes.

▶ 104

Switch panels



Illumination of the indicator lamp indicates the state of the corresponding function.

 <p>Deactivation of parking sensors.</p> <p>▶ 148</p>	 <p>Activation of lane departure warning system.</p> <p>▶ 139</p>	 <p>Push button starting/stopping.</p> <p>▶ 31, 35</p>
 <p>Deactivation of the DSC/ASR system.</p> <p>▶ 189</p>	 <p>Deactivation of the alarm.</p> <p>▶ 89</p>	 <p>Locking/unlocking the passenger compartment.</p> <p>▶ 87</p>
 <p>Forced operation of the Diesel engine.</p> <p>▶ 46</p>	 <p>Opening the fuel filler flap.</p> <p>▶ 95</p>	 <p>Electric parking brake activated.</p> <p>▶ 126</p>
 <p>Activation for Automatic headlamp dipping.</p> <p>▶ 157</p>	 <p>Opening the boot.</p> <p>▶ 88</p>	 <p>Electric child lock.</p> <p>▶ 181</p>

Sitting comfortably

Front seats

Manual

1. Head restraint height and angle adjustment.
2. Backrest angle adjustment.
3. Seat cushion height adjustment.
4. Seat forwards-backwards adjustment.
5. **Driver's** lumbar support adjustment.

▶ 100

Electric

1. Angle, seat height and seat forwards-backwards adjustment.
2. Backrest angle adjustment.
3. **Driver's** lumbar support adjustment.
4. Manual cushion adjustment.

▶ 101



Instruments and controls

1. Bonnet release lever.
2. Headlamp height adjustment.
3. Side adjustable air vents.
4. Front door window demisting/defrosting vents.
5. Quarter light demisting windows.
6. Head-up display.
7. Windscreen demisting/defrosting vent.
8. Passenger's airbag.
9. Glove box / Passenger's airbag deactivation inside.
10. 12 V accessory socket.
11. Rear electric window controls.
12. Central armrest with storage. USB port / auxiliary socket.
13. Electric parking brake.
14. Controls for electric windows / electric child lock / central locking.
15. eMyWay controls.
16. Gear selector.
17. Hybrid4 mode selector.
18. Heating / air conditioning controls.
19. Audio system.
20. Hazard warning lamps.
21. Multifunction screen.
22. Central adjustable air vents.
23. Clock.
24. Starting with the START/STOP button.
25. Electronic key reader.
26. Wiper / screenwash / trip computer stalk.
27. Audio equipment steering mounted controls.
28. Driver's airbag. Horn.
29. Cruise control / speed limiter controls.
30. Switch panel (see previous page).
31. Door mirror adjustment.
32. Lighting and direction indicator stalk
33. Instrument panel.
34. Seat belt and airbag warning lamps.
35. Courtesy lamp.
36. Head-up display controls.
37. Controls for cockpit glass roof blind.
38. CITROËN Localised Emergency Call - CITROËN Localised Assistance Call.

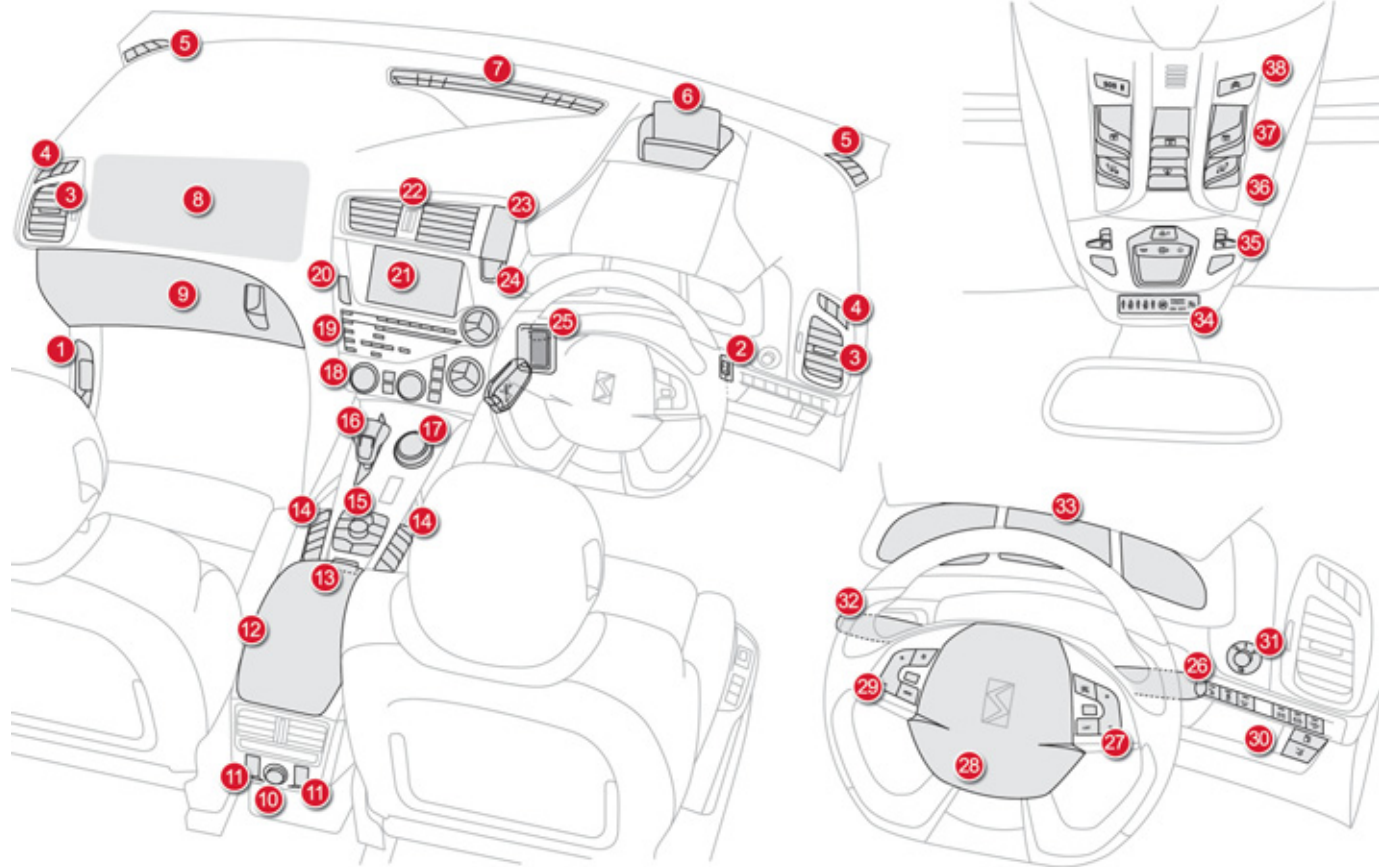

Sitting comfortably

Head restraint adjustment

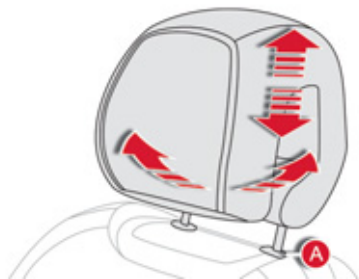

To lower it, simultaneously press button **A** and push down on the head restraint.

To raise it, guide the head restraint upwards to the desired position.

To incline it, swivel the lower part backwards or forwards.

Steering wheel adjustment

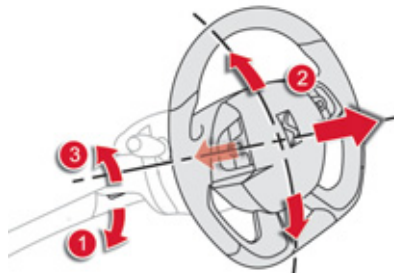

1. Release the adjustment mechanism.
2. Adjust for height and reach.
3. Lock the adjustment mechanism.

 For reasons of safety, these operations must only be carried out with the vehicle stationary.

Sitting comfortably

Door mirrors

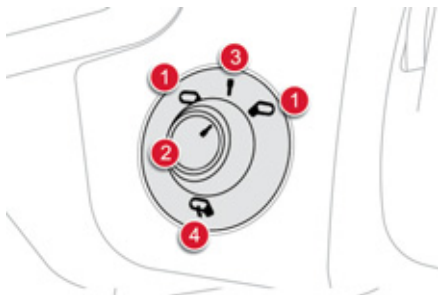

Adjustment

1. Selection of the left or right mirror.
2. Adjusting the position of the mirror glass.
3. Deselection of the mirror.
4. Folding the mirror.

▶ 108

Rear view mirror

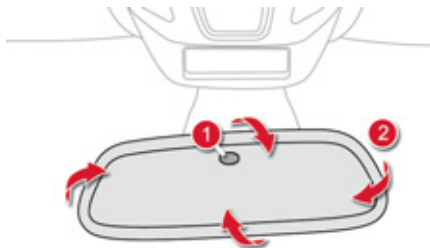

1. Automatic detection of day/night mode.
2. Rear view mirror adjustment.

▶ 109

Front seat belts

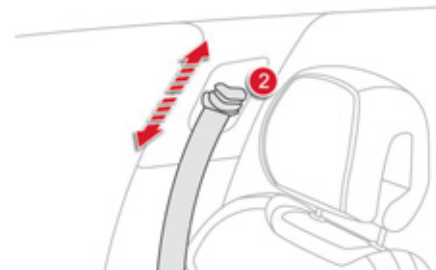
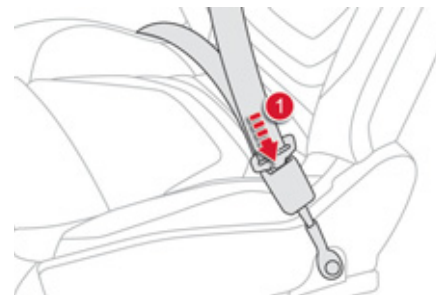

1. Fastening.
2. Adjusting for height.



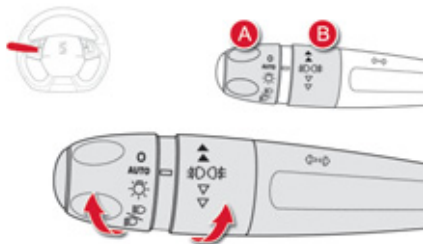

▶ 190

Seeing clearly



Lighting



Ring A

-  Lighting off.
-  Automatic illumination of headlamps.
-  Sidelamps.
-  Dipped / main beam headlamps.

Ring B

-  Front and rear foglamps.
-  153

Wipers

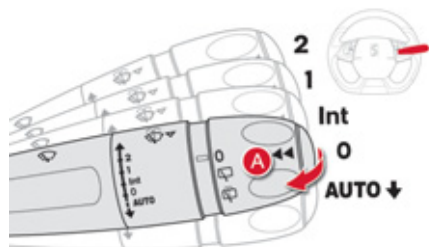

Control stalk A: windscreen wipers

- 2. Fast wipe.
- 1. Normal wipe.
- Int. Intermittent wipe.
- 0. Park.
- AUTO** Automatic wiping.

↓ Single wipe: Brief pull on the stalk towards you.
 Screenwash: Long pull on stalk towards you.

 163

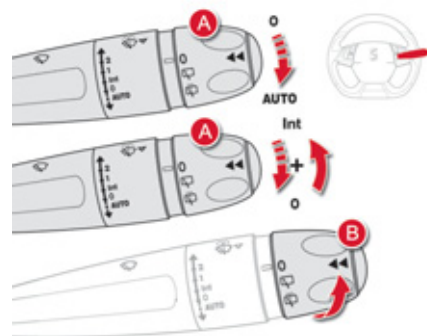

Switching on "AUTO" mode



 Briefly push the stalk downwards.

Switching off "AUTO" mode

 Briefly push the stalk downwards or place the stalk in another position: Int, 1 or 2.

 165

Ring B: rear wiper

-  Park.
-  Intermittent wipe.
-  Screenwash.

 164

Monitoring Instrument panel



On switching on, the dial needles go to the extent of their travel then return to 0.

- A.** With the ignition on, the bars indicate the fuel remaining.



- B.** With the ignition on, the instrument panel screen should indicate the oil level. If the levels are not correct, top up the level which is low.

▶ 58

Warning lamps



1. With the ignition on, the orange and red warning lamps come on.
 2. With the hybrid system active, these warning lamps should go off.
- If a warning lamp remains on, refer to the corresponding section.

▶ 59

Passenger safety

Front passenger's airbag

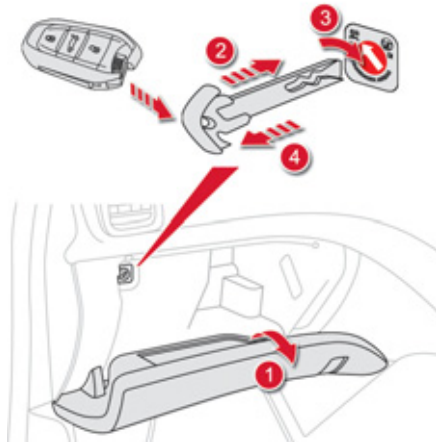

1. Open the glove box.
2. Insert the key (integral with the electronic key).
3. Select position:
"ON" (activation), with front passenger or "forwards facing" child seat,
"OFF" (deactivation), with "rear facing" child seat.
4. Remove the key keeping the switch in the new position.

Front seat belts and passenger's front airbag

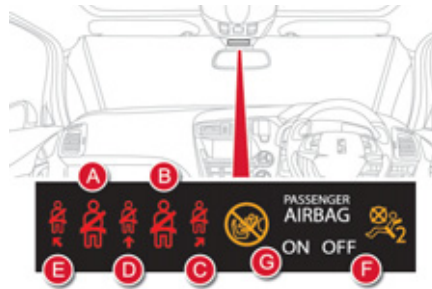

- A. Left hand front seat belt not fastened or unfastened warning lamp.
- B. Right hand front seat belt not fastened or unfastened warning lamp.
- C. Right hand rear seat belt not fastened or unfastened warning lamp.
- D. Centre rear seat belt not fastened or unfastened warning lamp.
- E. Left hand rear seat belt not fastened or unfastened warning lamp.
- F. Front passenger's airbag deactivated warning lamp.
- G. Front passenger's airbag activated warning lamp.

Driving safely

Starting - stopping the engine



Before starting

- Place the gear selector in position **N**.
- Insert the electronic key in the reader or keep the electronic key inside the vehicle.

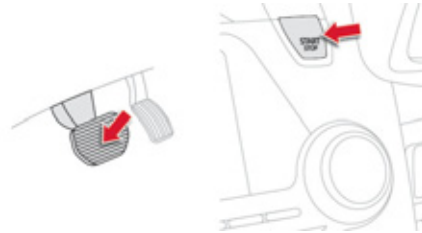

Starting

- Press the brake pedal.
- Make single short press (about 1 second) on the **START/STOP** button.

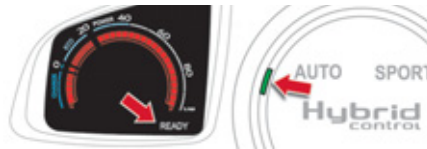

- The instrument panel and the **Ready** lamp come on, confirmed by an audible signal.
- The dial in the centre console is in **AUTO** mode.

Moving off

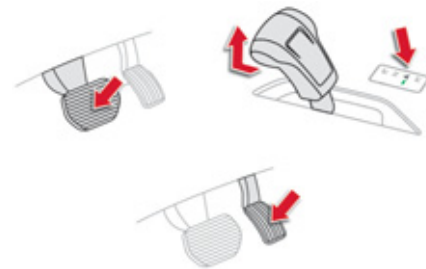

- While maintaining pressure on the brake pedal, move the gear selector to position **A** to go forwards or **R** for reverse.
- Take your foot off the brake pedal, you can then move off.

Driving safely

Electric parking brake

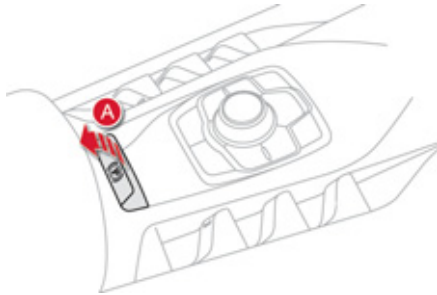

Manual Application/Release

Manual application of the parking brake is possible by **pulling** the control lever **A**.
With the ignition on, **manual release** of the parking brake is possible by **pressing the brake pedal** and **pulling** then **releasing** the control lever **A**.

 If an audible signal is heard on opening the driver's door with the hybrid system active, apply the parking brake manually.
Do not leave a child alone in the vehicle with the ignition on; they might release the parking brake.



Automatic Application / Release

Press the accelerator pedal, the parking brake is released automatically and progressively as you move off.
With the vehicle stationary, the parking brake is applied automatically on switching off the ignition (**Ready** lamp off).



If this warning lamp comes on in the instrument panel, automatic **application / release** is **deactivated**. The parking brake must be applied and released **manually**.

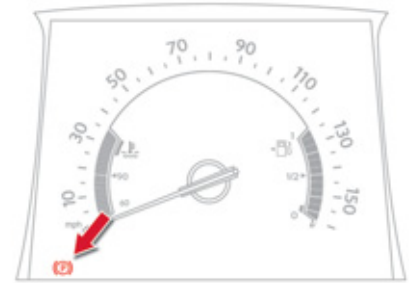

Before leaving the vehicle, check that the the brake warning lamp and the **P** warning lamp in the control lever **A** are **on fixed (not flashing)**.



If towing a trailer or caravan or if the slope might vary (transport by boat or lorry, recovery of the vehicle...) make a maximum application of the parking brake - by making a long pull on the control lever **A** - to immobilise the vehicle.

Driving safely

Speed limiter "LIMIT"

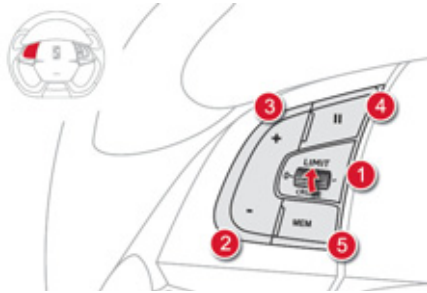

1. Selecting speed limiter mode.
2. Decrease the programmed value.
3. Increase the programmed value.
4. Pause/resume speed limiter.
5. Display of the memorised speeds (by the audio system memory).

These values must be set with the hybrid system active.

▶ 143

Cruise control "CRUISE"

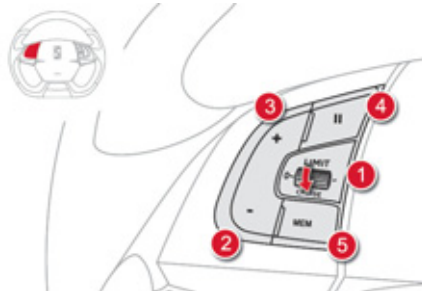

1. Selecting cruise control mode.
2. Programming a speed / Decrease the programmed value.
3. Programming a speed / Increase the programmed value.
4. Pause/resume cruise control.
5. Display of the memorised speeds (by the audio system memory).

In order to be programmed or activated, the vehicle speed must be higher than 25 mph (40 km/h), with at least 2nd gear engaged.

▶ 145

Display in the instrument panel



The cruise control or speed limiter mode appears in the instrument panel when selected.



Cruise control



Speed limiter

Hybrid system

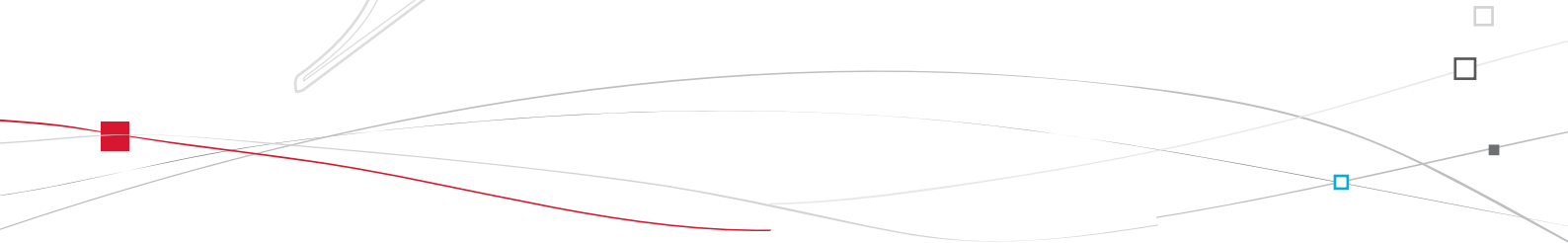

AUTO SPORT

Hybrid
Control

ZEV 4WD

R⁺

N

D

M

Presentation

The Hybrid4 technology allows two sources of energy to be associated in an effective manner: the Diesel HDi engine, which drives the front wheels and the electric motor, which drives the rear wheels.

These two motors can operate alternately or simultaneously, according to the hybrid mode selected and the driving conditions.

The electric motor alone provides power for the vehicle in "ZEV" (Zero Emissions Vehicle) mode, and in "Auto" mode for running at slow speed and low load. It also assists the Diesel engine when moving off, accelerating and changing gear.

The battery that powers the electric motor is recharged during phases of deceleration and stores the energy for subsequent use.

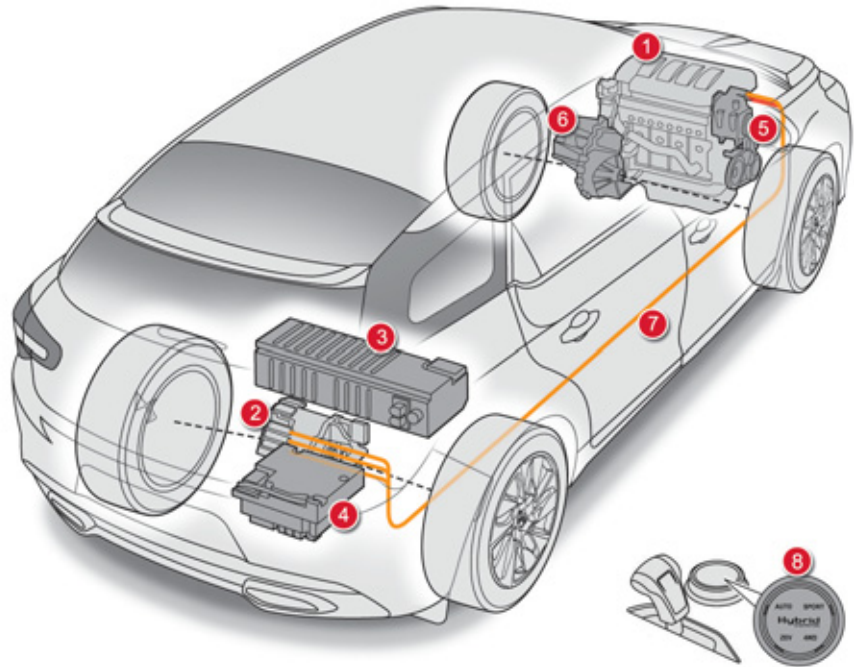

1. Diesel HDi engine (front wheel drive).
2. Electric motor (rear wheel drive).
3. 200 V battery.
4. Electronic power supervisor.
5. Stop & Start system.
6. 6-speed electronic gearbox.
7. Electrical flow.
8. Hybrid4 mode selector.

Main parts of the Hybrid4 system

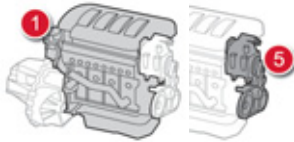

The **HDi Diesel engine - 1**, located at the front, drives the front wheels and provides most of the power needed to drive the vehicle. It is fitted with the **Stop & Start system - 5** which recharges the batteries and provides additional power when needed (in 4x4 mode).

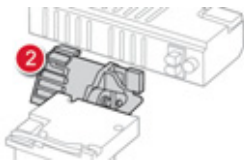

The **electric motor - 2**, located at the rear, drives the rear wheels on its own, or supplements the Diesel engine, according to the hybrid mode selected. It recovers energy and charges the batteries during phases of deceleration of the vehicle and is active up to 70 mph (120 km/h).

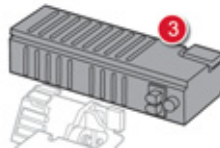

A 200 V NI-MH **high voltage battery - 3**, provides a source of energy for the rear electric motor. Its charging rate is managed automatically by the vehicle during phases of deceleration. It is located in a compartment in the boot, access to which is restricted to trained service technicians.



The battery **state of charge** is indicated by 8 horizontal or vertical bars (depending on the screen).

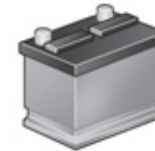

The **conventional battery**, located under the bonnet, powers the vehicle's 12 V systems. It is recharged automatically by the high voltage network.

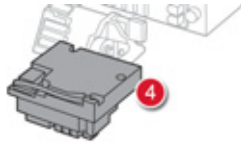

The **electronic power supervisor - 4** automatically manages the operation of the two power units (Diesel and electric) to provide the lowest consumption.

An inverter and a transformer are needed to manage the electric power.

The inverter acts on the torque of the electric motor, by regulating the current coming from the high voltage battery pack. Its operating range is between 150 and 270 volts.

The transformer converts the 200 V of the battery pack to 12 V, to power the vehicle's ancillary systems.

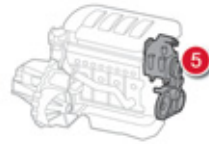

The **Stop & Start system - 5** allows the Diesel engine to be put into standby during stops (traffic lights, a stop, or in a traffic jam, for example) or during phases of running in all-electric mode.

The stopping and restarting of the Diesel engine is done in a way that is instantaneous and transparent for the driver.

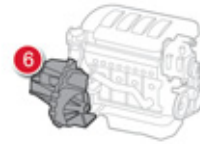

The **electronic gearbox - 6** provides, in automatic mode, significant savings in fuel consumption compared to a conventional manual gearbox, thanks to its electronic control system.

It also offers improved driving pleasure with the possibility at any time of choosing the gear changing mode: automatic or manual, using the paddles located behind the steering wheel.

Starting - switching off the engine

Before starting

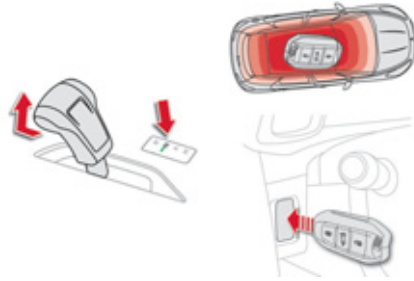

- Place the gear selector lever in position **N**.
- If your vehicle has Keyless Entry and Starting, simply having the key inside the vehicle is sufficient.
- If not, place the electronic key in the reader.

Starting the Hybrid4 system

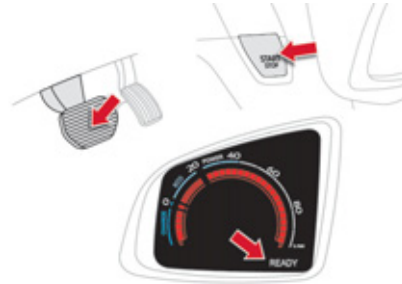

- Press the brake pedal.
- Make a single short press (about a second) on the **START/STOP** button.
- The steering column locks (noticeable noise and movement of the steering wheel).
- Keep your foot on the brake pedal until the Hybrid4 system starts up (the instrument panel and the **Ready** lamp come on, confirmed by an audible signal).

The hybrid system determines whether it is necessary to start the Diesel engine.

Switching off the Hybrid4 system

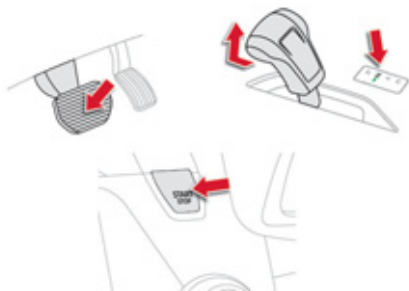

- Before switching off the Hybrid4 system, place the gear selector in position **N**.
- Make a short press on the **START/STOP** button.
- The system shuts down and the steering column locks.

 When stationary, switch off the ignition and check that the **Ready** lamp is off before leaving the vehicle, otherwise the hybrid system will still be active.

For more information, see the section on "Underbonnet precautions/warnings".

 **When your vehicle vehicle moves off in electric mode, it makes no noise. Be very careful of pedestrians as they will not hear you coming.**



Ignition on without starting the engine (accessory position)

With the electronic key in the reader or the Keyless Entry and Starting key inside the vehicle, pressing the "START/STOP" button, with no action on the pedals, allows the ignition to be switched on and so activate the ancillary equipment.

**START
STOP**

- ☞ Press the "START/STOP" button, the instrument panel comes on but the engine does not start.
- ☞ Press the button again to switch off the ignition and so allow the vehicle to be locked.



If you use the accessory position for too long, the system automatically goes into economy mode to avoid the risk of a flat battery.

Anti-theft protection

Electronic engine immobiliser

The keys contain an electronic chip which has a secret code. When the ignition is switched on, this code must be recognised in order for starting to be possible.

This electronic engine immobiliser locks the engine management system a few minutes after the ignition is switched off and prevents starting of the engine by anyone who does not have the key.

In the event of a malfunction, you are informed by a message in the instrument panel screen. In this case, your vehicle does not start; contact a CITROËN dealer as soon as possible.

Back-up starting with the Keyless Entry and Starting system

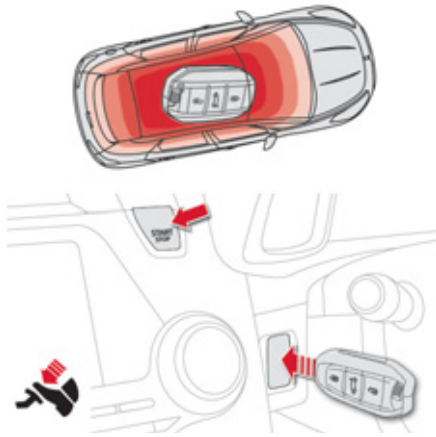

When the electronic key is in the defined zone and your vehicle does not start after pressing the "START/STOP" button:

- ☞ Insert the electronic key in the reader.
- ☞ Press the brake pedal.
- ☞ Press the "START/STOP" button.
The hybrid system is active.

Back-up switch-off



In the event of an emergency only, the engine can be switched off without any conditions. To do this, press and hold the "START/STOP" button for about 3 seconds. In this case the steering column locks as soon as the vehicle stops.

The electronic key must always remain inside the vehicle when in use.

Electronic key not recognised by the "Keyless Entry and Starting" system



If the electronic key is no longer in the defined zone when driving or when you (later) request switching off of the hybrid system, a message appears in the instrument panel.



- ☞ Press and hold the "START/STOP" button for about 3 seconds if you want to force switching off of the hybrid system (note that restarting will not be possible without the electronic key in the defined zone).

Ready lamp



On starting the vehicle: with the gear selector in position **N**, press the brake pedal and press the START/STOP button to activate the hybrid system.

This lamp comes on when the vehicle is ready to move off ("Auto" mode is on by default) and so the driver can press the accelerator.

This lamp comes on more or less instantly but may take a few seconds in some cases (in particular, the time needed for pre-heating the Diesel engine in cold weather or, for example, in energy economy mode, ...).

H With the vehicle stationary, press the START/STOP button and check that the **Ready** lamp is off when leaving the vehicle, otherwise the hybrid system will still be active.

For more information, refer to the section on "Underbonnet precautions / warnings".

Hybrid4 mode selector

The selector allows the user to choose between 4 drive modes for the vehicle. Turn the dial to the right or left; the mode selected is confirmed by illumination of the corresponding indicator.

AUTO mode, for normal use and optimised fuel consumption.

Sport mode, to make use of the maximum performance of the vehicle.

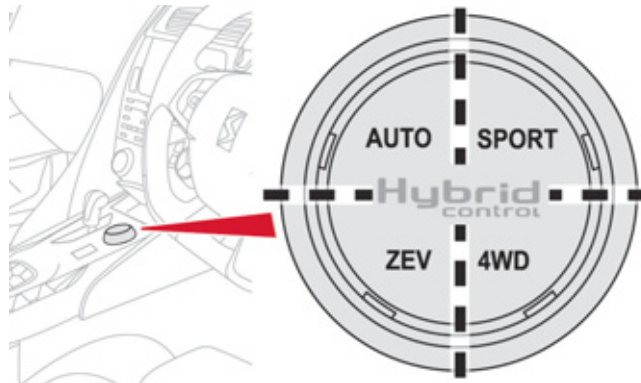

ZEV mode, to force electric running.

4WD mode, to force the vehicle into 4x4 mode.



Auto mode

 This **standard** mode to use in **preference** is activated **automatically** on starting the hybrid system.

It automatically manages the operation of the Diesel engine and the electric motor, according to inherent vehicle parameters, traffic conditions and driving style so as to **optimise the vehicle's fuel consumption**.

In particular, this mode activates "**zero emissions**" **electric running** when the conditions allow.

In auto mode, the **electric motor**:

- can drive the vehicle on its own up to around 36 mph (60 km/h) in "zero emissions" electric running, depending on the state of charge of the battery, if the conditions specific to the vehicle are met and if acceleration is moderate,
- **supplements the Diesel engine** when moving off and changing gear, during acceleration and when traction from the front wheels is inadequate (it automatically **adds 4 wheel drive**),
- is no longer active above 70 mph (120 km/h).



ZEV mode* (all electric)

Zero emissions vehicle operation is assured 100 % by electric drive.

This mode **forces silent running** at moderate speeds.



It can be activated when the required conditions are met, particularly if the state of charge of high voltage battery is sufficient (from 4 bars).

* ZEV: Zero Emissions Vehicle.



If the conditions do not allow this mode, a message that the "electric mode is not currently available" appears in the screen. The ZEV warning lamp flashes for a few seconds then goes off and the selector comes on in AUTO.

In ZEV mode:

- Range and acceleration capacity are limited. The maximum speed possible is around 36 mph (60 km/h).
- Under high load or a priority requirement causing the start of the Diesel engine, the system changes automatically to AUTO mode.



For more information on "Automatic restarting of the Diesel engine or ZEV mode not available", refer to the corresponding section.



Sport mode (Diesel and electric)

This mode allows more dynamic driving by providing **additional performance**. Vehicle acceleration and pick-up are maximised by using the capacity of the electric motor, supplementing the power of the Diesel engine.

This mode manages the progressiveness of the accelerator, the electronic gearbox and the use of the electric motor.

In Sport mode:

- The electric motor can be used up to 70 mph (120 km/h).

** 4WD: 4 Wheel Drive.

*** This mode will be even more effective if suitable tyres are fitted (winter tyres in particular).



4WD mode** (Diesel and electric)

This mode provides **additional traction***** at low speed by driving all 4 wheels of the vehicle continuously: the Diesel engine (front wheel drive) and the electric motor (rear wheel drive) operate simultaneously and permanently. Their coupling is managed electronically to optimise traction on slippery surfaces.

In 4WD mode:

- Power for the electric motor is provided, if needed, by the alternator-starter motor of the front engine. The Diesel engine operates continuously.
- The additional traction from the electric motor is available up to 75 mph (120 km/h).



This mode should be used on snow covered roads or difficult ground (mud, sand, ...). In this mode, in severe conditions and if the circumstances allow, it is recommended that you accelerate strongly to ensure that you move off and avoid any risk of getting stuck.

The addition of 4WD traction is available whatever:

- the state of charge of the traction battery,
- the altitude.

Energy consumption / generation indicator



The indicator dial provides real time information on the total power used, combining electric and Diesel.

It comprises three main zones.

ECO zone



Zone which indicates that the vehicle is **optimising its energy consumption**, electric, Diesel or a combination of both. This zone corresponds to phases of electric running as well as to phases of optimum use of the Diesel engine, which are easily accessible with a suitable driving style (smooth "eco-citizen" driving).

CHARGE zone

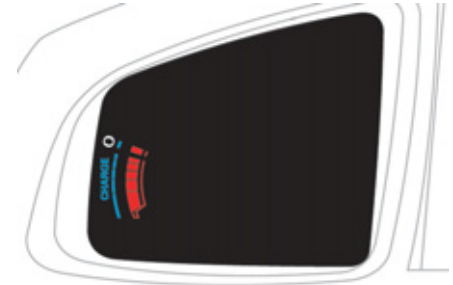

Zone which indicates that the vehicle is in electrical **energy recovery** phase: on deceleration, braking (partially or particularly with your foot off the accelerator (to use in preference as this gives better energy recovery). This allows the high voltage battery to be recharged using **"free" energy** which can then be **reused** for future energy requirements.



POWER zone

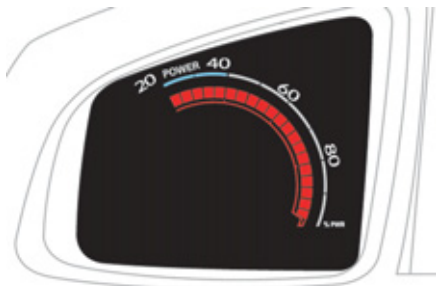

Zone which indicates an increased cumulative **power demand** from your hybrid vehicle, taking account of the combined power available from the Diesel engine and the electric motor.

View hybrid flow information

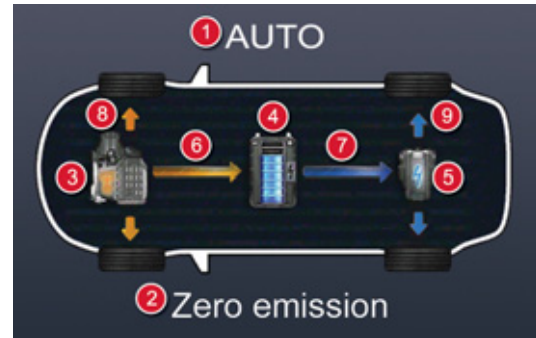
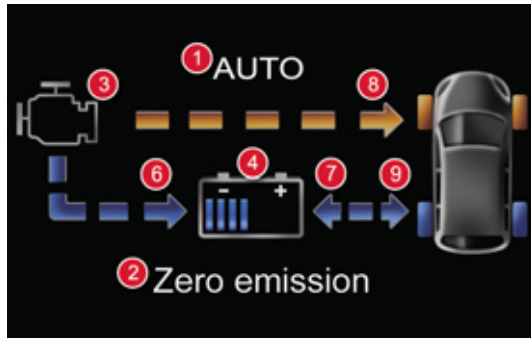

Information on the active hybrid mode, arrows for energy flows and the state of charge of the battery, is displayed in the instrument panel screen or the screen.

Hybrid modes

1. Hybrid mode selected (AUTO, ZEV, SPORT, 4WD).
2. Messages, e.g.: "Zero Emission" if the Diesel engine is off (0 g/km CO₂).

Vehicle infrastructure

3. Diesel engine.
4. Traction battery state of charge.
5. Electric Motor/Generator.

Operation / Energy flows

6. The Diesel engine supplies the battery (if needed).
7. Arrow from left to right: the battery powers the electric motor (when the electric motor is operating).
Arrow from right to left: the electric motor/generator recharges the battery (energy recovery phases).
8. The Diesel engine drives the front wheels.
9. The electric motor drives the rear wheels.

Examples of displays

On starting and when stationary

There is no flow of energy (the Stop & Start system stops and restarts the Diesel engine automatically).

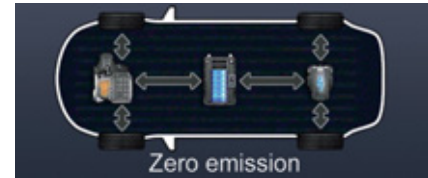
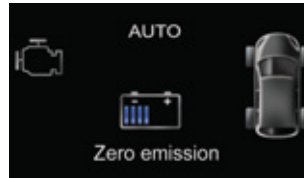

Energy recovery

During this phase (deceleration, braking, foot off the accelerator, ... all modes), the battery is recharged by the electric motor/generator, then being driven by the rear wheels. You can maximise this energy recovery by taking your foot off the accelerator pedal, deceleration will then be less marked than with a conventional vehicle.

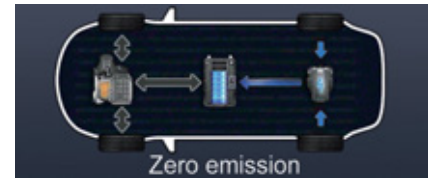

100% electric

In all electric running (AUTO or ZEV modes), only the electric motor, powered by the battery, drives the rear wheels. The display of "Zero Emission" indicates that the Diesel engine is off and the vehicle is producing no CO₂.

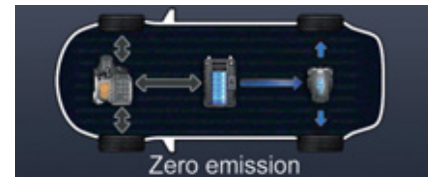

Automatic restarting of the Diesel engine or ZEV mode NOT available

The internal combustion engine may restart or ZEV mode may not be available in the various conditions presented below.

The internal combustion engine can be switched off automatically as soon as these conditions are lifted.

When the conditions described below cause the vehicle to come out of ZEV mode and the Diesel engine to restart, the vehicle automatically changes to AUTO mode.

Action by the driver

- Moving the gear selector to position **M**.
- Action on steering mounted control paddles to change gear.
- Sustained and sharp acceleration.
- Use of demisting.
- Use of air conditioning.

Maintaining the performance of the system

- When the vehicle exceeds 18 mph (30 km/h) after moving off (if the internal combustion engine has not already started since the vehicle was last started).
- If the high voltage battery is not sufficiently charged. A minimum of 4 bars in ZEV mode so as to ensure operation over a certain distance (in AUTO, electric operation is accessible for a shorter period with a lower level of charge).
- When the fuel level enters the reserve zone (where rate of consumption of this reserve is high, ZEV inhibition may continue for some time after refuelling).
- During regeneration of the particle emissions filter, which occurs automatically for 5 to 10 minutes, approximately every 300 miles (500 kms) (or less in extended urban running).

Difficult weather conditions and circumstances

- If certain conditions or engine temperature requirements make it necessary (such as an engine temperature that is too low for the ambient conditions).
- When the battery is close to maximum charge (for example: when going down a long hill), because engine recovery being no longer possible, the internal combustion engine restarts automatically just to provide engine braking.
- If the vehicle encounters a steep slope (car park ramp, ...).
- If the vehicle has been parked in the sun for a prolonged period.
- When driving in mountainous conditions (altitude).

Your vehicle is fitted with the most effective emissions control systems, in particular the Particle Emissions Filter (PEF).

At regular intervals your Diesel engine will produce energy for the self-cleaning of this filter.

During this PEF regeneration phase, electric running is purposely made unavailable and is accompanied by a message "**Electric mode not available: PEF regeneration in progress**".

Hybrid4 frequently asked questions

ZEV (Zero Emissions Vehicle) mode

Question	Answer
<p>Why is it not always possible for me to put the vehicle into ZEV (Zero Emissions Vehicle) mode even though the battery is well charged?</p>	<p>This situation is temporary. Certain conditions will occasionally prevent the change to ZEV mode, even if the battery has sufficient charge, such as, for example, very cold conditions, altitude, demisting, high demand for heating or air conditioning, regeneration of the particle emissions filter (PEF).</p>
<p>Why do I sometimes see an alert message "Electric mode not available: PEF regeneration in progress"?</p>	<p>This is an message relating to the regeneration of the particle emissions filter (PEF). This is a completely normal process that takes place every 240 or 300 miles (400 or 500 km) (or more frequently in prolonged urban use), as on a conventional HDi vehicle. This process is not generally noticed by the driver. On the other hand, in the case of a hybrid, this phenomenon may be noticeable (in urban use) as temporarily the HDi engine will not stop and this message will be displayed at intervals while regeneration is in progress.</p>
<p>Why is it not possible for me to put the vehicle into ZEV mode, even though I had just been running electrically in Auto mode?</p>	<p>The management of ZEV is different from Auto mode. Changing to ZEV mode is only possible with a battery charge of at least 4 bars, in order to assure sufficient range. In Auto mode, the system alone manages the conditions for changing temporarily to electric mode, for shorter periods and with a lower state of charge of the battery.</p>
<p>Why is the range in ZEV (Zero Emissions Vehicle) mode lower when climbing?</p>	<p>The vehicle needs more energy when climbing than when running on the level. So it is better to stay in Auto mode, which will favour operation of the Diesel engine.</p>
<p>Why is it that the system makes me come out of ZEV (Zero Emissions Vehicle) mode; it does not return to ZEV automatically when the conditions allow?</p>	<p>It is not intended to give preference to ZEV running at any cost, as it is not always the most economical mode. So the system returns automatically to Auto mode.</p>

Reducing consumption - Fuel

Question	Answer
How can I optimise my fuel consumption?	<p>Give preference to Auto mode as it selects in the best way the "driving energy source" to use in order to reduce fuel consumption.</p> <p>You should also adapt your driving style to the characteristics of hybrid vehicles to get the best out of it, for example by taking your foot off the accelerator pedal rather than braking and by anticipating decelerations (entering a built-up area, stop at traffic lights, stop at halt signs, ...).</p>
Why do I not manage to reduce my fuel consumption even though I often drive in ZEV (Zero Emissions Vehicle) mode?	<p>It is not ZEV mode but Auto mode that is the most appropriate for reducing fuel consumption, as it selects the best "driving energy source".</p> <p>ZEV mode (100% electric operation) can reduce fuel consumption in some cases. However, recharging the traction battery has an energy cost.</p> <p>This is why we recommend using Auto mode more often.</p>
Why does the trip computer sometimes display the bars for 28 mpg (10 litres) consumption in town?	<p>The current fuel consumption displayed may appear high when the distance covered is very low, but this generally has very little impact and the true average fuel consumption will remain low.</p> <p>In town, your hybrid retains very good fuel economy (of the order of 35% better than a non-hybrid vehicle).</p>
Why is my battery rarely fully charged?	<p>A partly charged battery is normal operation (4 to 5 bars on average in Auto mode).</p> <p>This allows some capacity to be left free for the recovery for energy when going downhill or taking when your foot off the accelerator.</p>
Why are there so many fuel alert messages when starting to use the reserve?	<p>To encourage you to refuel as soon as possible and avoid the loss of hybrid functions.</p>

Air conditioning

Question	Answer
It seems to me that the vehicle runs less on electric when the heating or air conditioning is operating, is that right?	The demand for heating or air conditioning may require the starting of the Diesel engine until the desired level of comfort is attained. Normal hybrid operation is simply put back. The period can be longer under low or very high ambient temperatures.
It seems to me that when it is very hot and the air conditioning is working, the vehicle runs on electric for shorter periods. Is that right?	When it is hot, the periods when the Diesel engine is put on standby and the vehicle runs on electric are necessarily restricted in order to limit the difference between the temperature in the vehicle and the level of comfort selected. In very hot weather, it is always possible to press the Eco OFF button (which brings the vehicle out of ZEV mode and prevents electric running or the stopping of the engine) to give preference to temperature control (keeps the air conditioning running).

Special Hybrid4 features

Question	Answer
Can I tow with my hybrid vehicle and how much?	A Hybrid4 vehicle can tow between 500 kg and 800 kg (see the "Towing" section). This allows a jet ski or two-wheeler on a trailer to be towed, for example. The "technical" reason for the limit is related to maintaining adequate cooling capacity for the internal combustion engine as well as the hybrid components that are also cooled by the engine's cooling system.
Why does engine braking seem so strong?	When you take your foot off the accelerator, the engine braking results mainly from the energy recovery by the electric motor. This leads to a higher level of deceleration than a conventional vehicle and so allows the recovery of free energy.

ECO OFF switch

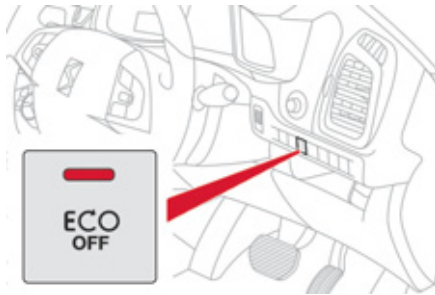

This function prevents the Diesel engine being switched off and so ensures that a comfortable temperature can be maintained in the passenger compartment (air conditioning running continuously).

On pressing the switch, the engine restarts immediately.

To return to normal operation, press the switch again.

After switching off the ignition, the vehicle will return to normal operation (lamp in the switch off).

During electric running and when the engine is stopped, the hybrid system manages restarting automatically to assure comfort levels in the passenger compartment*.

However, variations in temperature may still be felt in very hot climates. To avoid any discomfort in these conditions you can operate the ECO OFF switch.

* Except in ZEV mode, which favours electric running over assuring a comfortable temperature.

Eco-driving

Eco-driving is a range of everyday practices that allow the motorist to optimise their fuel consumption and CO₂ emissions.

Eco-driving suited to your Hybrid4 vehicle

Use gear selector position **A**, as this optimises gear changes to suit the circumstances, and the **AUTO** mode of the Hybrid4 mode selector.

When moving off, accelerate normally up to the desired speed (**POWER** zone between 20 and 40 %).

At steady speeds, drive gently with small movements of the accelerator pedal (**ECO** or **CHARGE** zone), run in electric mode as often as possible when driving at low speed.

Anticipate the need to slow down and use engine braking (**CHARGE** zone), so as to make use of free energy recovery while keeping light pressure on the accelerator pedal.

Control the use of your electrical equipment

Before moving off, if the passenger compartment is too warm, ventilate it by opening the windows and air vents before using the air conditioning.

Above 30 mph (50 km/h), close the windows and leave the air vents open.

Remember to make use of equipment that can help keep the temperature in the passenger compartment down (sun roof and window blinds...).

Switch off the air conditioning, unless it has automatic digital regulation, as soon as the desired temperature is attained.

Switch off the demisting and defrosting controls, if not automatic.

Switch off the heated seat as soon as possible.

Switch off the headlamps and front foglamps when the level of light does not require their use.

Avoid running the Diesel engine when stationary, particularly in winter; your vehicle will warm up much faster while driving.

As a passenger, if you avoid connecting your multimedia devices (film, music, video game...), you will contribute towards limiting the consumption of electrical energy, and so of fuel.

Disconnect your portable devices before leaving the vehicle.

Limit the causes of excess consumption

Spread loads throughout the vehicle; place the heaviest items in the bottom of the boot, as close as possible to the rear seats.

Limit the loads carried in the vehicle and reduce wind resistance (roof bars, roof rack, bicycle carrier, trailer...). Use a roof box in preference.

Remove roof bars and roof racks after use.

At the end of winter, remove snow tyres and refit your summer tyres.

Observe the recommendations on maintenance

Check the tyre pressures regularly, when cold, referring to the label in the door aperture, driver's side.

Carry out this check in particular:

- before a long journey,
- at each change of season,
- after a long period out of use.

Have your vehicle serviced regularly (engine oil, oil filter, air filter...) and observe the schedule of operations recommended by the manufacturer.

When refuelling, do not continue after the 3rd cut-off of the nozzle to avoid any overflow.

At the wheel of your new vehicle, it is only after the first 1 800 miles (3 000 kilometres) that you will see the fuel consumption settle down to a consistent average.

Consumption of your hybrid in the screen



Average consumption over the last 5 minutes.

"60 % Hybrid Use" corresponds to 60 % of the cumulative running time with the addition of the hybrid system and 40 % of the time with the Diesel engine only (with no contribution from the hybrid system).

i For more information on the trip computer, refer to the corresponding section.

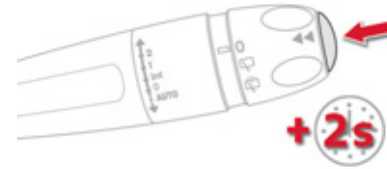

Resetting the history

With the hybrid system active, when trip 2 displayed, press the control for 2 seconds to reset the history to zero.

200 V high voltage battery

Charging

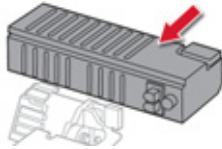

The 200 V high voltage battery cannot be recharged from a mains supply. The battery is Ni-MH (Nickel Metal Hydride) and is located below the boot floor, close to the electric motor.



The battery is charged when the vehicle decelerates, the electric motor then becomes a generator and converts kinetic energy into electrical energy (except if the speed of the vehicle is above 70 mph (120 km/h)). The battery is not recharged from a mains supply. The battery may also be charged automatically when required by the Stop & Start system of the Diesel engine.

This recovery allows the use of "free" energy. The battery charging time is very short and is continuous.

A discharged battery (following ZEV running or high load, for example) will quickly return to a state of charge sufficient for full operation of the different hybrid modes.

The **charging takes place automatically when driving.**

The energy recovery can be faster during deceleration.

The average state of charge is 4 to 5 bars, so preserving a margin for energy recovery when deceleration of going downhill (free energy).

i To preserve the service life of the battery, the level of charge never falls below 20 %, even if a level of 0 bars is displayed after ZEV running. Where the battery is close to maximum, vehicle deceleration with your foot off the accelerator pedal will be at a lower level.

Fan cooling of the high voltage battery

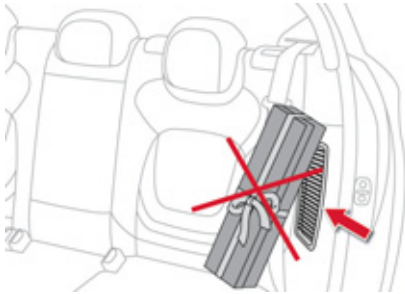

This system does not work continuously, but adapts the force of the fan cooling to the requirements of the battery. Its operation can be heard at the rear, even if the vehicle is stopped after a run. If the air intake is blocked, the battery may overheat, damaging the battery and causing a loss of performance of the hybrid system.



For the best use of the high voltage battery, please follow these recommendations:

- do not obstruct the air intake with loose articles, otherwise, the battery may overheat, causing a loss of performance of the hybrid system
- do not spill fluids, as this may cause damage to the battery.



The high voltage battery has an air cooling system, comprising an air intake (located on the side of the left hand rear seat) and a fan (located behind the left hand boot trim panel).

High voltage

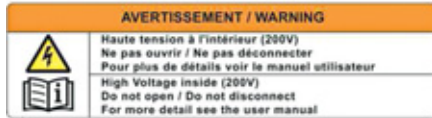

The voltage used for the operation of the electric motor is in the range 150 to 270 Volts. Be sure to take account of the warning labels fitted to the vehicle.

Take great care regarding the high voltage and high temperatures of components carrying the current.

READY

Before doing any work on the vehicle, switch off the ignition (**Ready** lamp off).

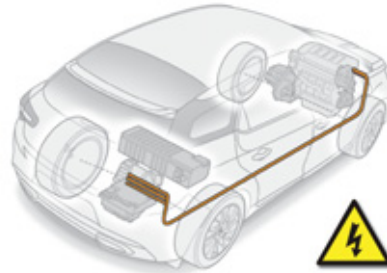

Never touch, dismantle, remove or replace the high voltage parts, orange cables or connectors, even in the event of an accident.

Emergency cut-off

In the event of an accident, a cut-off system blocks the high voltage current and cuts off the fuel pump; your vehicle can no longer be started.

To restart the hybrid system, contact a CITROËN dealer.

Battery precautions

The high voltage battery must not in any circumstances be charged from an external source and must only be handled by a workshop technician.

There is the risk of serious burns, as well as electric arcs that could cause serious injury or even death.

A used Ni-MH (Nickel Metal Hydride) type high voltage battery must be removed in an appropriate manner by a repair workshop, so that its recycling presents no risk to the environment.

High voltage cables

High voltage cables are routed under the vehicle (sills); take care not to damage them when the vehicle is used for off-road activity (such as covering rough ground).



Take care to position lifting equipment (jack, hoist, ...) at the locations provided to avoid damaging the cables.

Underbonnet precautions / warnings

READY

Always ensure that the ignition is switched off (**Ready** lamp off) before opening the bonnet.

The alternator-starter motor of your hybrid vehicle is also supplied at high voltage. If the vehicle ignition has not been switched off, there is a risk of the engine restarting at any time.

⚠ Also ensure that the ignition is switched off when refuelling to avoid the engine restarting.

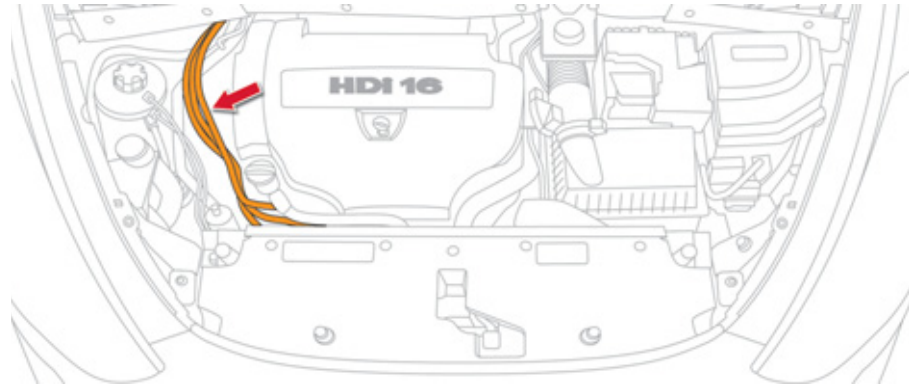
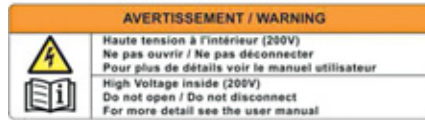

Car washing machine or tunnel



Some car washing machines or tunnels (where the vehicle is moved forwards on a travelling track) require that the parking brake be "released" during the wash.

Car washing machines or tunnels in which the Diesel engine must be switched off.

- i** With the hybrid system active, **Ready** lamp on, parking brake released:
- Place the gear selector in position **N**.
 - Switch off the engine (press on START/STOP). The parking brake is applied automatically and the **Ready** lamp goes off in the instrument panel.
 - Switch on the ignition again (press on START/STOP) without your foot on the brake pedal. The **Ready** lamp remains off.
 - Release the parking brake using the manual control on the centre console, while keeping your foot on the brake pedal.
 - Switch off the ignition (press on START/STOP without your foot on the brake pedal) checking that the parking brake remains released.

Car washing machines or tunnels in which the Diesel engine must not be switched off.

- i** With the hybrid system active, **Ready** lamp on, parking brake released:
- Place the gear selector in position **N** (Auto or Sport mode).
 - Press the brake pedal then the ECO OFF button.

If the Diesel engine is not running, it restarts.

If the Diesel engine is running, it remains running without time limit.

Vehicle recovery

Before doing any work, with the ignition on, press the brake pedal and put the gear selector to position **N**, then switch off the hybrid system.

If necessary because access to the vehicle is difficult, it can be moved a few dozen metres at a speed not exceeding 6 mph (10 km/h).

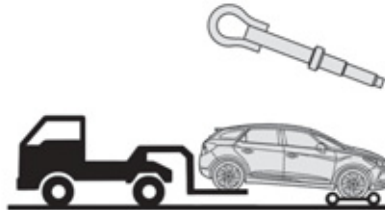
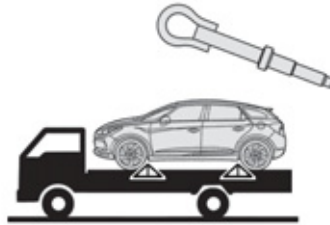

The front or rear wheels must not be on the ground, use a flat-bed lorry or trailer to recover the vehicle.

Use the towing eyes only to pull a vehicle out or to pull it onto a flat-bed.

001 Instruments and controls

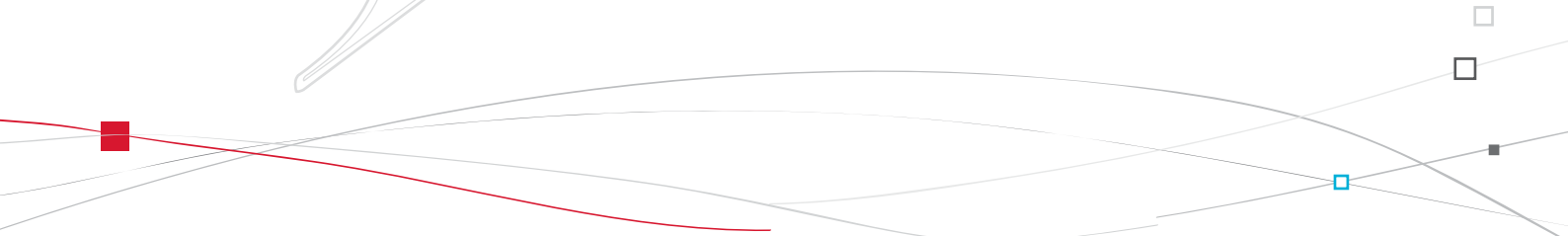



PAUSE
0 km/h
D
130 km/h
4.6 min
3.56 km

Instrument panel



Dials and screens

1. Energy consumption / generation indicator (available power as a percentage).
For more information refer to the "Hybrid system" section.
2. Fuel gauge.
3. Engine coolant temperature gauge.
4. Speedometer (mph or km/h).
5. Cruise control or speed limiter settings.
6. Gear engaged.
7. Instrument panel screen: electrical flow, trip recorder, alert messages or state of functions (e.g.: oil pressure, battery, door open, ...), trip computer, media, satellite navigation.
8. Digital speedometer (mph or km/h).
9. Ready lamp: indicates that the vehicle is ready to drive.

Control buttons

- A.** Main lighting and controls dimmer.
- B.** - Successive short presses: under-inflation detection, recall servicing information, alert log.
- Long press: reset the function selected to zero (service indicator or trip recorder).



Indicator and warning lamps

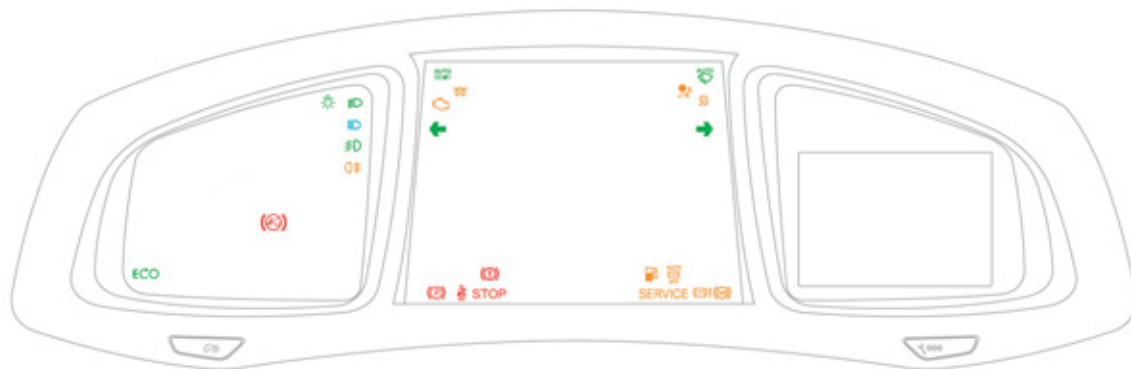

Visual indicators informing the driver that a system is in operation, switched off or has a fault.

When the ignition is switched on

Certain warning lamps come on for a few seconds in the instrument panel and/or instrument panel screen when the vehicle's ignition is switched on.

When the engine is started, these same warning lamps should go off. If they remain on, before moving off, refer to the information on the warning lamp concerned.









Associated warnings

The switching on of certain warning lamps may be accompanied by an audible signal and a message in the instrument panel screen. The warning lamps may come on continuously (fixed) or flash.

 Certain warning lamps may come on in one of two modes: fixed (continuous) or flashing. Only by relating the type of illumination to the operation of the vehicle can it be determined whether the situation is normal or a fault has occurred. Refer to the tables on the following pages for more information.





Operation indicator lamps



If one of the following indicator lamps comes on in the instrument panel and/or instrument panel screen, this confirms that the corresponding system has come into operation.

Warning / indicator lamp		State	Cause	Action / Observations
	Ready	fixed.	The vehicle is ready to move off; you can press the accelerator.	It comes on once high voltage is established in the vehicle.
	Left-hand direction indicator	flashing with buzzer.	The lighting stalk is pushed down.	
	Right-hand direction indicator	flashing with buzzer.	The lighting stalk is pushed up.	
	Sidelamps	fixed.	The lighting stalk is in the "Sidelamps" position.	
	Dipped beam headlamps	fixed.	The lighting stalk is in the "Dipped beam headlamps" position.	
	Main beam headlamps	fixed.	The lighting stalk is pulled towards you.	Pull the stalk to return to dipped beam headlamps.
	Automatic headlamp dipping	fixed.	The lighting stalk has been pulled towards you and the button (to the right of the steering wheel) has been pressed. Its warning lamp is on.	The camera, located in the interior rear view mirror, authorises or not switching between main and dipped beam, depending on the exterior lighting and the driving conditions. Pull the lighting stalk to return to dipped beam.
	Front foglamps	fixed.	The front foglamps are switched on.	Turn the ring on the stalk rearwards twice to switch off the front foglamps.

 For more information on the lighting controls, refer to the corresponding section.





Warning / indicator lamp	State	Cause	Action / Observations
	Rear foglamps	fixed.	The rear foglamps are switched on. Turn the ring on the stalk rearwards to switch off the rear foglamps.
	Diesel engine pre-heating	fixed.	The START/STOP switch has been pressed (ignition on). Wait until the warning lamp goes off before starting. The period of illumination of the warning lamp is determined by the ambient conditions (up to about thirty seconds in extreme conditions). If the engine does not start, switch the ignition off and then on, wait until the warning lamp goes off again, then start the engine.
	Electric parking brake	fixed.	The electric parking brake is applied. Release the electric parking brake to switch off the warning lamp: with your foot on the brake pedal, pull the electric parking brake control lever. Observe the safety recommendations. For more information on the electric parking brake, refer to the corresponding section.
	Deactivation of the automatic functions of the electric parking brake	fixed.	The "automatic application" (on switching off the engine) and "automatic release" functions are deactivated or faulty. Activate the function (according to country) via the vehicle configuration menu or contact a CITROËN dealer or a qualified workshop if automatic application / release is not possible. The parking brake can be released manually using the emergency release procedure. For more information on the electric parking brake, refer to the corresponding section.

Warning / indicator lamp	State	Cause	Action / Observations
 Foot on the brake pedal	fixed.	The brake pedal is not pressed.	Press the brake pedal to start the hybrid system (gear selector in position N). If you wish to release the parking brake without pressing the brake pedal, this warning lamp will remain on.
	flashing.	If you hold the vehicle on a rising incline using the accelerator for too long, the clutch overheats.	Use the brake pedal and/or the electric parking brake.
 Automatic wiping	fixed.	The wiper control is pushed downwards.	Automatic front wiping is activated. To deactivate automatic wiping, operate the control stalk downwards or put the stalk into another position.
 Passenger's airbag system	fixed in the seat belt and passenger's front airbag warning lamps display.	The control switch, located in the glove box, has been placed in the "ON" position. The passenger's front airbag is activated. In this case, do not install a "rear facing" child seat.	Move the control switch to the "OFF" position to deactivate the passenger's front airbag. In this case, you can install a "rear facing" child seat.



Deactivation indicator lamps

If one of the following indicator lamps comes on, this confirms that the corresponding system has been switched off intentionally. This may be accompanied by an audible signal and a message in the instrument panel screen.

Warning / indicator lamp	State	Cause	Action / Observations
 Passenger's airbag system	fixed in the instrument panel and/or seat belt and front passenger's airbag warning lamps display.	The control switch, located in the glove box, is set to the OFF position. The passenger's front airbag is deactivated.	Set the control to the "ON" position to activate the passenger's front airbag. In this case, do not fit a child seat in the rear-facing position.
 Dynamic stability control (DSC/ASR)	fixed.	The button, located at the bottom right of the dashboard, is pressed. Its indicator lamp is on. The DSC/ASR is deactivated. DSC: dynamic stability control. ASR: anti-slip regulation, or traction control.	Press the button to activate the DSC/ASR. Its indicator lamp goes off. The DSC/ASR system is activated automatically when the vehicle is started. If it has been deactivated, the system is reactivated automatically from approximately 30 mph (50 km/h).



Warning lamps





With the hybrid system active or when the vehicle is being driven, illumination of one of the following warning lamps indicates a fault which requires action on the part of the driver.

Any fault resulting in the illumination of a warning lamp must be investigated further by reading the associated message in the instrument panel screen. If you encounter any problems, contact a CITROËN dealer or a qualified workshop.





Warning / indicator lamp		State	Cause	Action / Observations
STOP	STOP	fixed, associated with another warning lamp, accompanied by an audible signal and a message in the screen.	It is associated with a punctured wheel, the braking system, the power steering, the engine oil pressure, the engine coolant temperature, the hybrid system or a major electrical fault.	Stop as soon as it is safe to do so as the engine may cut out. Park, switch off the ignition and call a CITROËN dealer or a qualified workshop.
SERVICE	Service	on temporarily.	A minor fault has occurred for which there is no specific warning lamp.	Identify the fault by reading the message shown in the screen, such as, for example: <ul style="list-style-type: none"> - the closing of the doors, boot or bonnet, - the engine oil level, - the screenwash level, - the remote control battery, - the tyre pressures, - saturation of the particle emission filter (Diesel). - ... For any other faults, contact a CITROËN dealer or a qualified workshop.
		fixed.	A major fault has occurred for which there is no specific warning lamp.	Identify the fault by reading the message shown on the screen and contact a CITROËN dealer or a qualified workshop.
	PEF: particle emissions filter, Diesel	fixed, associated temporarily with a message on the risk of blockage of the PEF.	This indicates the start of saturation of the particle emissions filter.	As soon as traffic conditions allow, regenerate the filter by driving at a speed of at least 35 mph (60 km/h) until the service warning lamp goes off.
		fixed.	This indicates the low level in the Diesel additive reservoir.	Have the level topped up by a CITROËN dealer or a qualified workshop as soon as possible.



Warning / indicator lamp	State	Cause	Action / Observations
 Electric parking brake	flashing.	The electric parking brake is not applied automatically. The application/release is faulty.	You must stop as soon as it is safe to do so. Park on flat level ground, switch off the ignition and contact a CITROËN dealer or a qualified workshop.
 Electric parking brake fault	fixed.	The electric parking brake has a fault.	Contact a CITROËN dealer or a qualified workshop without delay. The parking brake can be released manually using the emergency release procedure. For more information on the electric parking brake, refer to the corresponding section.
 Deactivation of the automatic functions of the electric parking brake	fixed.	The "automatic application" (on switching off the engine) and "automatic release" functions are deactivated or faulty.	Activate the function (according to country) via the vehicle configuration menu or contact a CITROËN dealer or a qualified workshop if automatic application / release is not possible. The parking brake can be released manually using the emergency release procedure. For more information on the electric parking brake, refer to the corresponding section.

Warning / indicator lamp	State	Cause	Action / Observations
	Braking	fixed.	You must stop as soon as it is safe to do so. Top up with brake fluid listed by CITROËN. If the problem persists, have the system checked by a CITROËN dealer or a qualified workshop.
+ 		fixed, associated with the ABS warning lamp.	The electronic brake force distribution (EBFD) system has a fault.
	Anti-lock Braking System (ABS)	fixed.	The vehicle retains conventional braking. Drive carefully at reduced speed and contact a CITROËN dealer or a qualified workshop without delay.
	Dynamic stability control (DSC/ASR)	flashing.	The system optimises traction and improves the directional stability of the vehicle.
		fixed.	Unless it has been deactivated (button pressed and its indicator lamp on) the DSC/ASR system has a fault.
	Engine autodiagnosis system	flashing.	Risk of destruction of the catalytic converter. Have it checked by a CITROËN dealer or a qualified workshop.
		fixed.	The emission control system has a fault.



Warning / indicator lamp	State	Cause	Action / Observations
 Low fuel level	fixed with the two last bars flashing.	When it first comes on there remains approximately 6 litres of fuel in the tank.	<p>You must refuel as soon as possible to avoid running out of fuel.</p> <p>This warning lamp will come on every time the ignition is switched on, until a sufficient addition of fuel is made.</p> <p>Fuel tank capacity: approximately 60 litres.</p> <p>Never continue to drive until you run out of fuel as this could damage the emission control and injection systems.</p>
 Seat belt(s) not fastened / unfastened	fixed or flashing accompanied by an audible signal.	A seat belt has not been fastened or has been unfastened.	Pull the strap then insert the tongue in the buckle.
 Airbags	on temporarily.	This lamp comes on for a few seconds when you turn on the ignition, then goes off.	This lamp should go off when the engine is started. If it does not go off, contact a CITROËN dealer or a qualified workshop.
	fixed.	One of the airbag or seat belt pretensioner systems has a fault.	Have it checked by a CITROËN dealer or a qualified workshop.
 Directional headlamps	flashing.	The directional headlamps system has a fault.	Have it checked by a CITROËN dealer or a qualified workshop.

Coolant temperature gauge

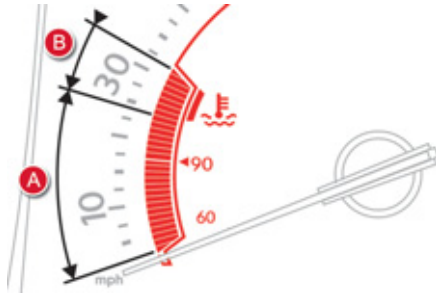

With the hybrid system active:

- in zone **A**, the temperature is correct,
- in zone **B**, the temperature is too high; the central **STOP** warning lamp comes on, accompanied by an audible signal and a message in the instrument panel screen.

You must stop as soon as it is safe to do so.

Wait a few minutes before switching off the engine.

Contact a CITROËN dealer or a qualified workshop.

After driving for a few minutes, the temperature and pressure in the cooling system increase.

To top up the level:

- ☞ wait for the engine to cool,
- ☞ unscrew the cap by two turns to allow the pressure to drop,
- ☞ when the pressure has dropped, remove the cap,
- ☞ top up the level to the "MAX" mark.

 Be aware of the risk of burns when topping up the cooling system. Do not fill above the maximum level (indicated on the reservoir).

Service indicator

System which informs the driver when the next service is due, in accordance with the manufacturer's servicing schedule.

The point at which the service is due is calculated from the last indicator zero reset. It is determined by two parameters:

- the distance travelled,
- the time elapsed since the last service.



More than 1 800 miles (3 000 km) remain before the next service is due

When the ignition is switched on, no service information appears in the screen.

Between 600 miles (1 000 km) and 1 800 miles (3 000 km) remain before the next service is due

For 5 seconds after the ignition is switched on, the spanner symbolising the service operations comes on. The distance recorder display line indicates the distance remaining before the next service is due.

Example: 1 700 miles (2 800 km) remain before the next service is due.

For 5 seconds after the ignition is switched on, the screen indicates:

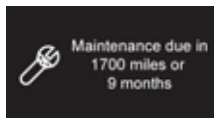

5 seconds after the ignition is switched on, **the spanner goes off**; the distance recorder resumes its normal operation. The screen then indicates the total and trip distances.

Less than 600 miles (1 000 km) remain before the next service is due

Example: 560 miles (900 km) remain before the next service is due.

For 5 seconds after the ignition is switched on, the screen indicates:

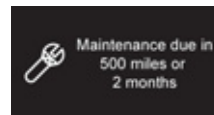

5 seconds after the ignition is switched on, the distance recorder resumes its normal operation. **The spanner remains on** to indicate that a service must be carried out soon.

i Illumination of the key is accompanied by a message in the instrument panel screen.

Service overdue

Every time the ignition is switched on, an overdue service is immediately signaled by flashing of the spanner and the fixed illumination of the **Service** warning lamp.

SERVICE



5 seconds after the ignition is switched on, the distance recorder resumes its normal operation. **The spanner remains on.**

i The distance remaining may be weighted by the time factor, depending on the driving conditions. Therefore, the spanner may also come on if you have exceeded the period since the last service, indicated in the **maintenance and warranty guide**.

Service indicator zero reset

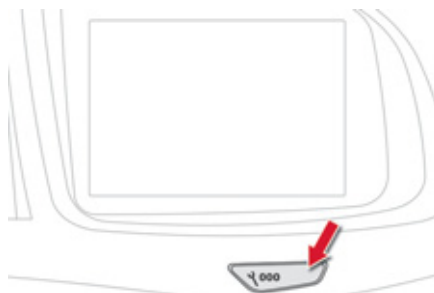

After each service, the service indicator must be reset to zero.

The procedure for resetting to zero is as follows:

- ☞ switch off the ignition,
- ☞ press and hold the trip distance recorder zero reset button,
- ☞ switch on the ignition; the distance recorder display begins a countdown,
- ☞ when the display indicates "**0**", release the button; the spanner disappears.

i Following this operation, if you wish to disconnect the battery, lock the vehicle and wait at least five minutes for the zero reset to be taken into account.

Retrieving the service information

You can access the service information at any time.

- ☞ Press the trip distance recorder zero reset button.

The service information is displayed for a few seconds, then disappears.



Engine oil level indicator

System which informs the driver whether the engine oil level is correct or not. This information is indicated for a few seconds when the ignition is switched on, after the service information.

i The level read will only be correct if the vehicle is on level ground and the engine has been off for more than 30 minutes.



Oil level correct

This is indicated by a message in the instrument panel screen.



Oil level incorrect

This is indicated by a message in the instrument panel screen. If the low oil level is confirmed by a check using the dipstick, the level must be topped up to avoid damage to the engine.



Oil level indicator fault

This is indicated by a message in the instrument panel screen. Contact a CITROËN dealer or a qualified workshop.

Dipstick

Refer to the "Checks" section to locate the dipstick and the oil filler cap on your engine.



There are 2 marks on the dipstick:

- **A** = max; never exceed this level,
- **B** = min; top up the level via the oil filler cap, using the grade of oil suited to your engine.

Total distance recorder



System which measures the total distance travelled by the vehicle during its life. The total and trip distances are displayed for thirty seconds when the ignition is switched off, when the driver's door is opened and when the vehicle is locked or unlocked.

Trip distance recorder



System which measures a distance travelled during a day or other period since it was reset to zero by the driver.

- ☞ With the ignition on, press the button until zeros appear.

Lighting dimmer

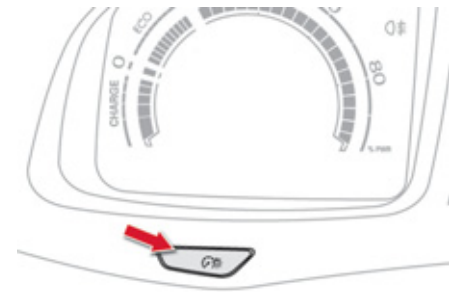

System for manual adjustment of the brightness of the instruments and controls in relation to the exterior brightness.

Activation

When the lighting is on:

- ☞ press the button to change the brightness of the instruments and controls,
- ☞ when the level of brightness required is reached, release the button.

Deactivation

When the lighting is off, or in day mode on vehicles fitted with daytime running lamps, pressing the button does not have any effect.

i To conform to legislation in the country you are crossing, change the units of distance (miles or km) via the configuration menu.

Black panel (black screen) with eMyWay



System allowing certain screens to be switched off for night driving (available only with eMyWay).

The instrument panel remains on with the vehicle speed, electronic gearbox gear selected, cruise control or speed limiter information, if in use, and the low fuel alerts if necessary.

If there is an alert or a change in a function or to a setting, the black panel mode is interrupted.

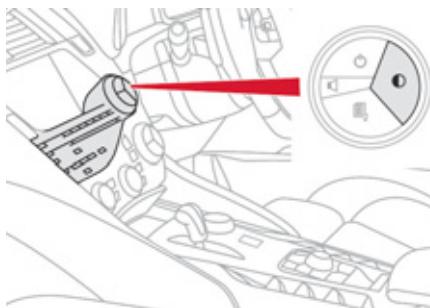

 For more information, refer to the eMyWay part of the "Audio and telematics" section.

Setting the date and time

Clock

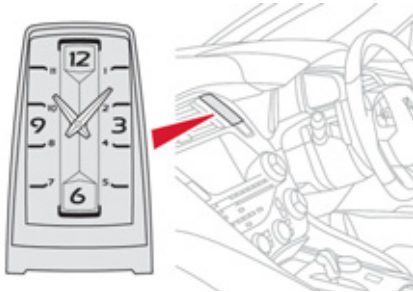

The analogue clock does not have an adjustment button.

To set the time, refer to the section relating to the screen (audio system) configuration menu. The clock is synchronised with the screen time; once the the setting has been confirmed in the screen, the hands will turn to synchronise with the screen, and each time the ignition is switched on.

Audio system / Bluetooth

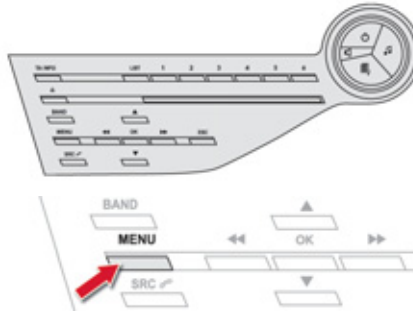

Press **MENU**.

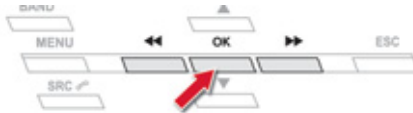

Using the arrows, select "**Personalisation-configuration**" and confirm.



Using the arrows, select "**Display configuration**" and confirm.

Using the arrows, select "**Date and time adjustment**" and confirm.

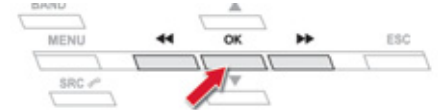

Select the setting to be modified. Confirm by pressing **OK**, then make the change and confirm again to save the modification.

Adjust the settings one by one, confirming by pressing the **OK** button. Next select the "**OK**" tab on the screen then confirm to exit from the "**Date and time adjustment**" menu.

eMyWay

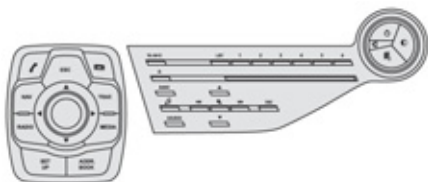

Press **SETUP** to display the "**Configuration**" menu.



Select "**Display configuration**" and confirm.

Select "**Set date and time**" and confirm.

i Select "**Synchronize the minutes with GPS**" so that setting the minutes is done automatically by satellite reception.

Select the setting to adjust.

Confirm by pressing **OK**, then adjust the setting and confirm again to save the modification.

Adjust the settings one by one.

Then select "**OK**" on the screen and confirm to save the settings.

i The clock, located in the dashboard, is synchronised with the time in the screen. It is set once the time is adjusted using the "**SETUP**" menu and every time the ignition is switched on.

Trip computer

System that gives you information on the journey in progress (range, fuel consumption...).

Instrument panel screen



Information display

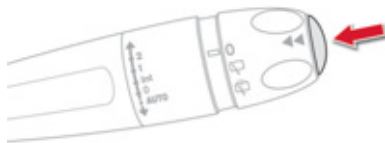

☞ Press the button on the end of the **wiper control stalk** to display the various tabs in succession.



- The current information tab with:
 - the range,
 - the current fuel consumption,



- Trip "1" with:
 - the average speed, for the first trip.
 - the average fuel consumption,



- Trip "2" with:
 - the average speed, for the second trip.
 - the consumption history (with 16/9 colour screen),
 - the average fuel consumption,

- Radio or media.
- Satellite navigation.

Reset trip

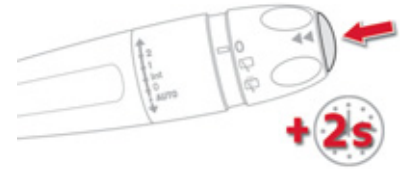

☞ When the trip required is displayed, press the control for more than two seconds or use the left hand thumb wheel of the steering mounted controls.

Reset history

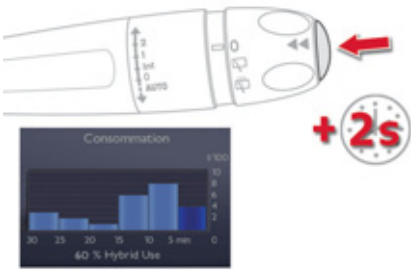

☞ With trip 2 displayed, press the button (on the end of the wiper stalk) for more than two seconds to reset the history to zero.

Trips "1" and "2" are independent but their use is identical.

For example, trip "1" can be used for daily figures, and trip "2" for monthly figures.

Trip computer, a few definitions...



Range

(miles or km)

This indicates the distance which can still be travelled with the fuel remaining in the tank in relation to the average fuel consumption over the last few miles (kilometres) travelled.



This value may vary following a change in the style of driving or the relief, resulting in a significant change in the current fuel consumption.

When the range falls below 20 miles (30 km), dashes are displayed. After filling with at least 5 litres of fuel, the range is recalculated and is displayed when it exceeds 60 miles (100 km).



If dashes are displayed continuously while driving in place of the digits, contact a CITROËN dealer or a qualified workshop.



Current fuel consumption

(mpg or l/100 km or km/l)

This is the average fuel consumption during the last few seconds.



This function is only displayed from 20 mph (30 km/h).



Average fuel consumption

(mpg or l/100 km or km/l)

This is the average fuel consumption since the last trip computer zero reset.



Average speed

(mph or km/h)

This is the average speed calculated since the last trip computer zero reset (ignition on).

002
Access

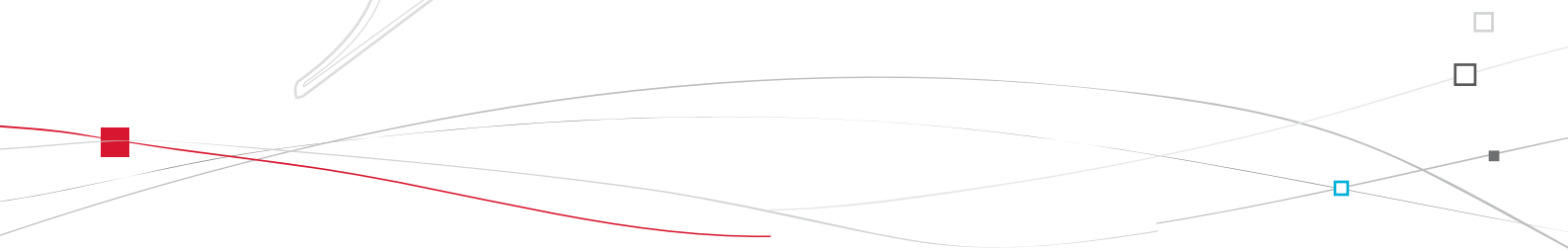



Electronic key remote control

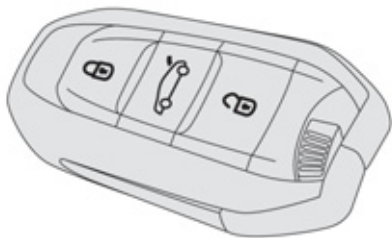

System which permits central unlocking or locking of the vehicle using the lock or from a distance. It is also used to locate and start the vehicle, as well as providing protection against theft.

Unlocking the vehicle

Complete unlocking



☞ Press the open padlock to unlock the vehicle.

Selective unlocking



This setting is done in the configuration menu. Complete unlocking is activated by default.



☞ To unlock only the driver's door, press the open padlock once.

☞ To unlock the other doors and the boot, press the open padlock again.



Unlocking is confirmed by rapid flashing of the direction indicators for around two seconds.

At the same time, depending on version, the door mirrors unfold.

Unlocking the boot



☞ Press this button until you hear the boot unlock.

Locking the vehicle



☞ Press the closed padlock to lock the vehicle completely. Hold the button down until the windows close completely.



Locking is confirmed by fixed lighting of the direction indicators for approximately two seconds. The door mirrors fold at the same time.

Be aware of children when operating the windows.

"Keyless Entry and Starting" system

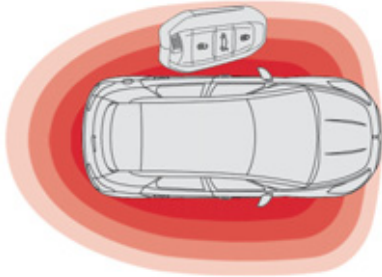

System that allows the opening, closing and starting of the vehicle while keeping the electronic key on your person.

i It can also be used as a remote control; see the "Electronic key/remote control" section.

Accumulations (water, dust, grime, salt...) on the inner surface of the door handle may affect detection.

If cleaning the inner surface of the door handle using a cloth does not resolve the problem, contact a CITROËN dealer or a qualified workshop.

A sudden splash of water (stream of water, high pressure jet washer, ...) may be identified by the system as the desire to open the vehicle.

Unlocking the vehicle

Complete unlocking

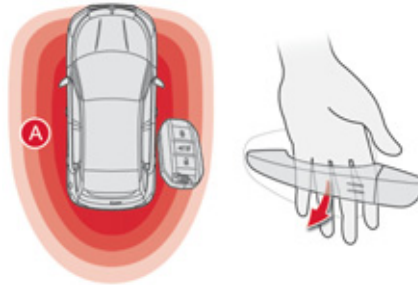

- ☞ With the electronic key on your person and in the defined zone **A**, pass your hand behind the door handle to unlock the vehicle, then pull on the handle to open the door.
Your passengers can also open their doors, as soon as the electronic key is in the defined zone around the vehicle.

Selective unlocking



This setting is done via the configuration menu.

By default, complete unlocking is activated.

- ☞ To unlock only the driver's door, with the electronic key on your person, pass your hand behind the driver's door handle then pull on the door handle to open.
- ☞ To unlock the complete vehicle, pass your hand behind one of the passenger door handles on the same side of the vehicle as the electronic key is located, then pull on the door handle to open.



Unlocking is confirmed by rapid flashing of the direction indicators for approximately two seconds.

The door mirrors unfold at the same time.

If the alarm is on, the audible warning when opening a door with the key (integral with the remote control), will stop on starting the engine.

Locking the vehicle

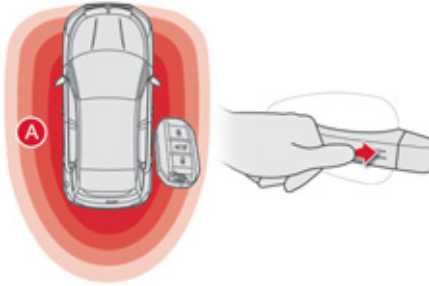

☞ With the electronic key in the defined zone **A**, press with a finger on one of the door handles (at the markings) to lock the vehicle. Maintain pressure with your finger until the windows close completely.

i Locking is confirmed by fixed lighting of the direction indicators for approximately two seconds. The door mirrors fold at the same time.

! Ensure that no one prevents the correct operation of the windows. Be aware of children when operating the windows.

i If one of the doors or the boot is still open or if the key for Keyless Entry and Starting has been left inside the vehicle, the central locking does not take place. When the vehicle is locked, if it is unlocked inadvertently, it will lock itself again automatically after about thirty seconds unless a door is opened. The folding and unfolding of the door mirrors by the remote control can be deactivated by a CITROËN dealer or a qualified workshop.

! As a safety measure (children on board), never leave the vehicle without taking the key for the Keyless Entry and Starting system, even for a short period. Guard against theft when the key for the Keyless Entry and Starting system is in the defined zone with the vehicle unlocked. In order to preserve the charge of the cell battery in the remote control, the "hands-free" functions go into extended stand-by after 21 days of non-use. To restore these functions, press one of the remote control buttons or start the engine with the electronic key in the reader.

Ignition on without starting the engine (accessory position)

With the electronic key in the reader or the Keyless Entry and Starting key inside the vehicle, pressing the "START/STOP" button, with no action on the pedals, allows the ignition to be switched on and so activate the ancillary equipment.

**START
STOP**

- ☞ Press the "START/STOP" button, the instrument panel comes on but the engine does not start.
- ☞ Press the button again to switch off the ignition and so allow the vehicle to be locked.

⚠ If you use the accessory position for too long, the system automatically goes into economy mode to avoid the risk of a flat battery.

Deadlocking

⚠ Deadlocking renders the exterior and interior door controls inoperative. It also deactivates the manual central control button. Therefore, never leave anyone inside the vehicle when it is deadlocked.

Using the remote control



- ☞ Press the closed padlock to lock the vehicle completely. Maintain pressure with your finger for more than two seconds to close the windows.
- ☞ Press the closed padlock again within five seconds to deadlock the vehicle.

⚠ Ensure that no one is preventing the correct closing of the windows. Be aware of children when operating the windows.

With the Keyless Entry and Starting system

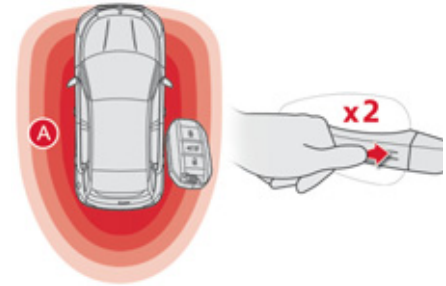

By the doors:

- ☞ With the electronic key in the defined zone **A**, press a finger on the door handle (at the markings) to lock the vehicle.
- ☞ Within five seconds, press the door handle again to deadlock the vehicle.

Back-up control

Unlocking/locking using the integral key

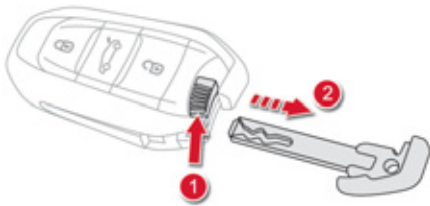

The integral key is used to lock and unlock the vehicle when the electronic key cannot operate:

- cell battery flat, vehicle battery discharged or disconnected, ...
 - vehicle located in an area with strong electromagnetic signals.
- ☞ Maintain a pull on button 1, to extract the integral key 2.

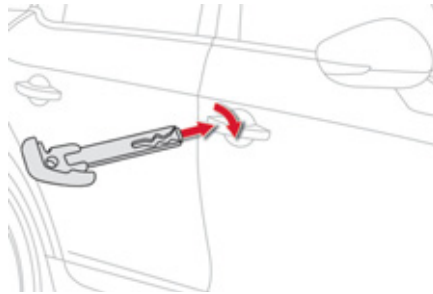

Complete unlocking

- ☞ Turn the key towards the front of the vehicle to unlock the vehicle.

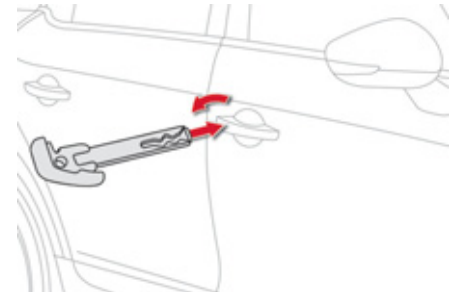

Normal locking

- ☞ Turn the key towards the rear of the vehicle to lock the vehicle completely.

Deadlocking

- ☞ Turn the key towards the rear in the driver's door lock to lock the vehicle completely.
- ☞ Turn the key towards the rear again within five seconds to deadlock the vehicle.

Remote control problem - reinitialisation

Following disconnection of the vehicle battery, replacement of the remote control battery or in the event of a remote control malfunction, you can no longer unlock, lock or locate your vehicle.

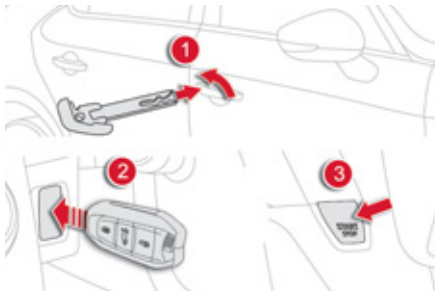

- ☞ Place the mechanical key (integral with the remote control) in the lock to unlock your vehicle.
- ☞ Place the electronic key in the reader.
- ☞ Switch on the ignition by pressing START/ STOP.

The electronic key is fully operational again. If the problem persists, contact a CITROËN dealer or a qualified workshop as soon as possible.

Changing the battery of the electronic key

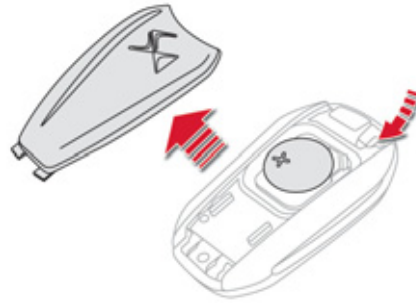

Battery ref.: CR2032 / 3 volts.

This replacement battery is available from a CITROËN dealer or a qualified workshop. A message appears in the instrument panel screen when replacement of the battery is needed.

- ☞ Unclip the cover using a small screwdriver at the cutout.
- ☞ Lift off the cover.
- ☞ Remove the flat battery from its location.
- ☞ Fit the new battery into its location observing the original direction of fitment.
- ☞ Clip the cover onto the casing.



Do not throw the remote control batteries away, they contain metals which are harmful to the environment. Take them to an approved collection point.



Lost electronic key

Visit a CITROËN dealer with the vehicle's registration document and your personal identification documents and if possible the key code label. The CITROËN dealer will be able to retrieve the key code and the transponder code required to order a new key.

Electronic key

The electronic key is a sensitive system; do not operate it while it is in your pocket as there is a possibility that it may unlock the vehicle, without you being aware of it.

Do not repeatedly press the buttons of your electronic key out of range and out of sight of your vehicle. You run the risk of stopping it from working and the remote control would have to be reinitialised.

The electronic key cannot operate as a remote control when it is in the reader or even when the ignition is switched on.

Locking the vehicle

Driving with the doors locked may make access to the passenger compartment by the emergency services more difficult in an emergency.

As a safety precaution (with children on board), take the Keyless Entry and Starting electronic key when you leave the vehicle, even for a short time.

Electrical interference

The Keyless Entry and Starting electronic key may not operate if close to certain electronic devices: telephone, laptop computer, strong magnetic fields, ...

Anti-theft protection

Do not make any modifications to the electronic engine immobiliser system; this could cause malfunctions.

Don't forget to turn the steering to engage the steering lock.

When purchasing a second-hand vehicle

Have all of the keys in your possession paired by a CITROËN dealer, to ensure that only your keys allow your vehicle to be unlocked and started.

Central locking control

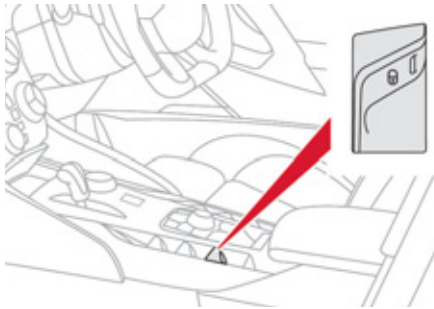

☞ Operate the button.
This allows the doors and the boot to be locked or unlocked.

⚠ If the vehicle is deadlocked or locked from the outside, the button is not active. In this case, use the remote control to unlock the vehicle or pull an interior door handle to open a door. If one of the doors is open, central locking from the inside does not take place.

Automatic central locking of the doors (anti-intrusion security)

The doors and boot can lock automatically while driving (speed above 6 mph (10 km/h)). To activate or deactivate this function (activated by default):

☞ Operate this button until a message appears in the instrument panel screen.

⚠ Driving with the doors locked may make access to the passenger compartment by the emergency services more difficult in an emergency.

ℹ **Transporting long or voluminous objects**
If you want to drive with the boot open, press the central locking control button to lock the doors.

Locating your vehicle

☞ Press the closed padlock to locate your locked vehicle in a car park.

This is indicated by lighting of the courtesy lamps and flashing of the direction indicators for a few seconds.

Boot

Opening from outside

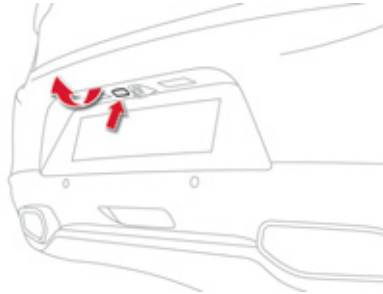

- ☞ After unlocking the boot or the vehicle using the electronic key - remote control, press the opening control then raise the tailgate.

Opening from inside

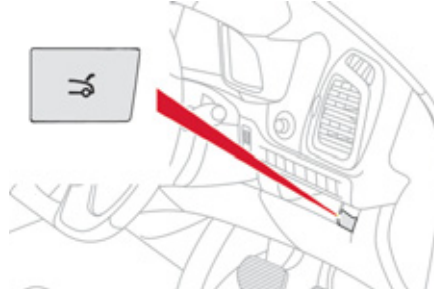

- ☞ Press this button until the boot is heard to unlock.

Closing

- ☞ Lower the tailgate using the interior grab handle.

If the tailgate is not closed correctly, with the **hybrid system active** or the **vehicle moving** (speed above 6 mph (10 km/h)), a message appears in the instrument panel screen for a few seconds.

Tailgate release

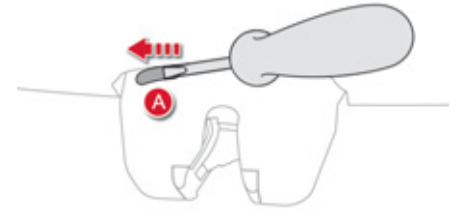

System allowing the mechanical unlocking of the boot in the event of a battery or central locking system malfunction.

Unlocking

- ☞ Fold back the rear seats to gain access to the lock from inside the boot.
- ☞ Insert a small screwdriver into hole **A** of the lock to unlock the tailgate.
- ☞ Move the latch to the left.

Locking after closing

If the fault persists after closing again, the boot will remain locked.

Alarm

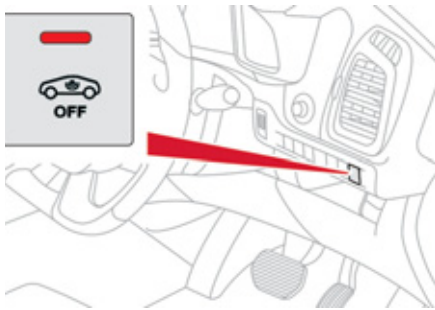

System which protects and provides a deterrent against theft and break-ins. It provides the following types of monitoring:

- Exterior perimeter

The system checks for opening of the vehicle. The alarm is triggered if anyone tries to open a door, the boot or the bonnet...

- Interior volumetric

The system checks for any variation in the volume in the passenger compartment. The alarm is triggered if anyone breaks a window, enters the passenger compartment or moves inside the vehicle.

- Tilt

The system checks for any change in the attitude of the vehicle. The alarm is triggered if the vehicle is lifted, moved or knocked.

Self-protection function

The system checks for the putting out of service of its components. The alarm is triggered if the battery, the button or the wires of the siren are put out of service or damaged.

For all work on the alarm system, contact a CITROËN dealer or a qualified workshop.

Locking the vehicle with full alarm system

Activation

 Switch off the ignition and get out of the vehicle.



 Press the locking button on the remote control or lock the vehicle using the Keyless Entry and Starting system.

The monitoring system is active: the indicator lamp in the button flashes once per second. After the locking button on the remote control is pressed or the vehicle locked using the Keyless Entry and Starting system, the exterior perimeter monitoring is activated after a delay of 5 seconds, the interior volumetric monitoring after 45 seconds and the anti-tilt after one minute and 30 seconds. If an opening (door, boot...) is not closed fully, the vehicle is not locked but the exterior perimeter monitoring will be activated after a delay of 45 seconds.

Deactivation of the volumetric monitoring



 Press the unlocking button on the remote control or unlock the vehicle using the Keyless Entry and Starting system.



The volumetric protection system is deactivated: the indicator lamp in the button goes off.

Locking the vehicle with exterior perimeter monitoring only

Deactivate the interior volumetric and anti-lift monitoring to avoid unwanted triggering of the alarm in certain cases such as:

- leaving a window partially open,
- washing your vehicle,
- changing a wheel,
- having your vehicle towed,
- transportation by sea.

Deactivation of the interior volumetric and anti-tilt monitoring



☞ Switch of the ignition and within ten seconds, press this button until the indicator lamp is on continuously.

☞ Get out of the vehicle.



☞ Press the locking button on the remote control immediately or lock the vehicle using the Keyless Entry and Starting system.

The exterior perimeter monitoring alone is activated: the indicator lamp in the button flashes once per second.

To be effective, this deactivation must be carried out each time the ignition is switched off.

Reactivation of the interior volumetric and anti-tilt monitoring



☞ Press the unlocking button on the remote control or unlock the vehicle using the Keyless Entry and Starting system to deactivate the exterior perimeter monitoring.



☞ Press the locking button on the remote control or lock the vehicle using the Keyless Entry and Starting system to activate all the monitoring functions.



The indicator lamp in the button again flashes once per second.

Triggering of the alarm

This is indicated by sounding of the siren and flashing of the direction indicators for thirty seconds.

The monitoring functions remain active until the alarm has been triggered eleven times in succession.



When the vehicle is unlocked using the remote control or unlocked using the Keyless Entry and Starting system, rapid flashing of the indicator

lamp in the button informs you that the alarm was triggered during your absence. When the ignition is switched on, this flashing stops immediately.

Failure of the remote control

To deactivate the monitoring functions:

- ☞ Unlock the vehicle using the key (integral with the remote control) in the driver's door lock.
- ☞ Open the door; the alarm is triggered.
- ☞ Switch on the ignition; the alarm stops. The indicator lamp in the button goes off.

Locking the vehicle without activating the alarm

- ☞ Lock or deadlock the vehicle using the key (integral with the remote control) in the driver's door lock.

Operating fault

When the ignition is switched on, fixed illumination of the indicator lamp in the button indicates a fault in the system. Have it checked by a CITROËN dealer or a qualified workshop.

Automatic activation*

2 minutes after the last door or the boot is closed, the system is activated automatically.

- ☞ To avoid triggering the alarm on entering the vehicle, first press the unlocking button on the remote control or unlock the vehicle using the Keyless Entry and Starting system.

* According to country.



Electric windows

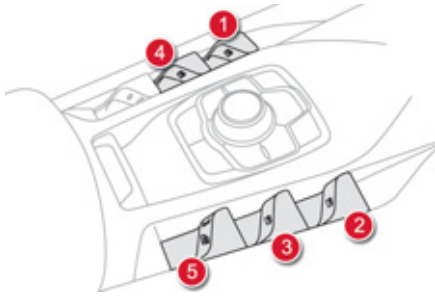

1. Left hand front electric window switch.
2. Right hand front electric window switch.
3. Right hand rear electric window switch.



4. Left hand rear electric window switch.
5. Deactivating the rear electric window switches, locking the rear doors (child lock).

Manual operation

To open or close the window, press or pull the switch gently. The window stops as soon as the switch is released.

Automatic operation

To open or close the window, press or pull switch fully: the window opens or closes completely when the switch is released. Pressing the switch again stops the movement of the window.

The electric window switches remain operational for approximately 45 seconds after switching off the ignition.

Once this time has elapsed, the electric windows will not operate. To reactivate them, switch the ignition on again.

Safety anti-pinch

When the window rises and meets an obstacle, it stops and immediately partially lowers again. In the event of unwanted opening of the window on closing, press the switch until the window opens completely, then pull the switch immediately until the window closes. Continue to hold the switch for approximately one second after the window has closed.

The safety anti-pinch function is not active during this operation.

Deactivating the rear window controls



For the safety of your children, press switch **5** to prevent operation of the rear windows irrespective of their position.

The warning lamp in the button comes on, accompanied by a message confirming activation. It remains on, as long as the child lock is activated.

The interior controls for the rear doors are also deactivated.

Opening the doors from the outside and operation of the rear electric windows from the driver's controls remain possible.

Reinitialisation of the electric windows

Following reconnection of the battery, the safety anti-pinch function must be reinitialised. The safety anti-pinch function is not active during these operations:

- lower the window completely, then raise it, it will rise in steps of a few centimetres each time the switch is pressed. Repeat the operation until the window closes completely,
- continue to press the switch for at least one second after reaching this position, window closed.



In the event of contact during operation of the windows, you must reverse the movement of the window. To do this, press the switch concerned. When operating the passenger electric window switches, the driver must ensure that no one is preventing correct closing of the windows. The driver must ensure that the passengers use the electric windows correctly. Be aware of children when operating the windows. Be aware of passengers or other persons present when closing the windows using the the electronic key or the "Access and Starting Hands Free" system.



Cockpit glass roof

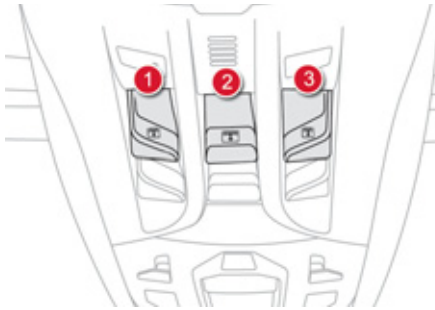

A tinted glass panoramic surface to increase the light and visibility in the passenger compartment.

Fitted with three electric blinds to improve temperature and noise related comfort.

Electric blinds

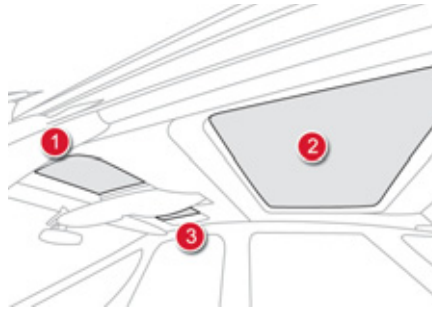

There are two options for opening and closing:

- ☞ Pull or press the control without going beyond the point of resistance (forwards to close and rearwards to open). When you release the control, the blind continues moving for around 2 cm, then stops.
- ☞ Pull or press control, going beyond the point of resistance. One press opens or closes the blind completely. After a new action on the the control, the blind continues moving for around 2 cm, then stops.

Safety anti-pinch

In automatic mode and at the end of its travel, if the blind meets an obstacle while closing it stops and moves back slightly.

Reinitialisation

If power to the blind is cut off while it is moving, the safety anti-pinch must be reinitialised:

- ☞ operate the control until the blind is fully closed,
- ☞ continue to press for at least 3 seconds.

A slight movement of the blind will then be noticeable, confirming the reinitialisation.

If the blind stops and immediately opens again during a closing manoeuvre:

- ☞ operate the control until the blind is fully open,
- ☞ then operate the control until the blind is fully closed.

The safety anti-pinch function is not operational during these operations.



If the blind meets an obstacle during operation, you must reverse the movement of the blind. To do this, press the control concerned.

When the driver operates the blind control, they must ensure that no one is preventing correct closing of the blind.

The driver must ensure that passengers use the blind correctly.

Be aware of children when operating the blind.

Fuel tank

Capacity of the tank: approximately 60 litres.

Opening

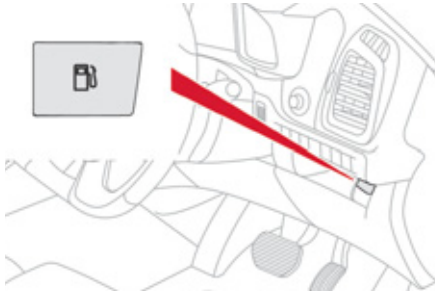

- ☞ Press the switch

This switch remains active for a few minutes after switching off the ignition. If necessary, switch the ignition on again to reactivate it.



With Stop & Start, never refuel with the system in STOP mode; you must switch off the ignition with the START/STOP button.

Refuelling

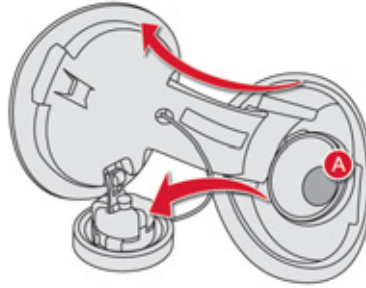

Additions of fuel must be of at least 5 litres to be registered by the fuel gauge. Opening the filler cap may result in an inrush of air. This vacuum is entirely normal and results from the sealing of the fuel system.

- ☞ Take care to select the pump that delivers the correct fuel type for your vehicle's engine (reminder on a label on the inside of the filler flap).
- ☞ Open the filler cap by turning it a 1/4 turn to the left.
- ☞ Remove the filler cap and hang it on its carrier (on the filler flap).

- ☞ Introduce the nozzle and push it in fully (pushing open the metal non-return valve A).
- ☞ Fill the tank (don't continue past the third cut-off of the nozzle, as this may cause malfunctions).
- ☞ Refit the filler cap turning it a 1/4 turn to the right.
- ☞ Push the filler flap to close it.

Your vehicle is fitted with a catalytic converter that reduces the levels of harmful substances in the exhaust gas.



If you have put in the wrong fuel for your vehicle, you must have the tank drained and refilled with the correct fuel before you start the engine.

Low fuel level



When the low fuel level in the tank is reached, this warning lamp comes on in the instrument panel, accompanied by an audible warning and a message in the instrument panel screen.

When it first comes on, around 6 litres of fuel remain in the tank.

You must refuel as soon as possible to avoid running out.

Fuel supply cut-off

Your vehicle is equipped with a safety device which cuts off the fuel supply in the event of a collision.

Misfuel prevention (Diesel)*

Mechanical device which prevents filling the tank of a Diesel vehicle with petrol. It avoids the risk of engine damage that can result from filling with the wrong fuel.

Located in the filler neck, the misfuel prevention device appears when the filler cap is removed.

Operation

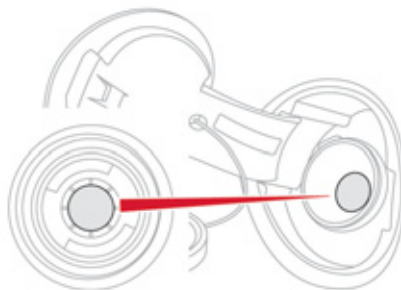

When a petrol filler nozzle is introduced into the fuel filler neck of your Diesel vehicle, it comes into contact with the flap. The system remains closed and prevents filling.

Do not persist but introduce a Diesel type filler nozzle.

i It remains possible to use a fuel can to fill the tank.
In order to ensure a good flow of fuel, do not place the nozzle of the fuel can in direct contact with the flap of the misfuel prevention device and pour slowly.

Travelling abroad

As Diesel fuel pump nozzles may be different in other countries, the presence of the misfuel prevention device may make refuelling impossible.

Before travelling abroad, we recommend that you check with the CITROËN dealer network, whether your vehicle is suitable for the fuel pumps in the country in which you want to travel.

* According to country of sale.



Quality of the fuel used for Diesel engines



DIESEL

The Diesel engines are perfectly compatible with biofuels which conform to current and future European standards (Diesel fuel which complies with standard EN 590 mixed with a biofuel which complies with standard EN 14214) available at the pumps (containing up to 7 % Fatty Acid Methyl Ester).

The B30 biofuel can be used in certain Diesel engines; however, this use is subject to strict application of the special servicing conditions. Contact a CITROËN dealer or a qualified workshop.

The use of any other type of (bio)fuel (vegetable or animal oils, pure or diluted, domestic fuel...) is strictly prohibited (risk of damage to the engine and fuel system).

003
Comfort

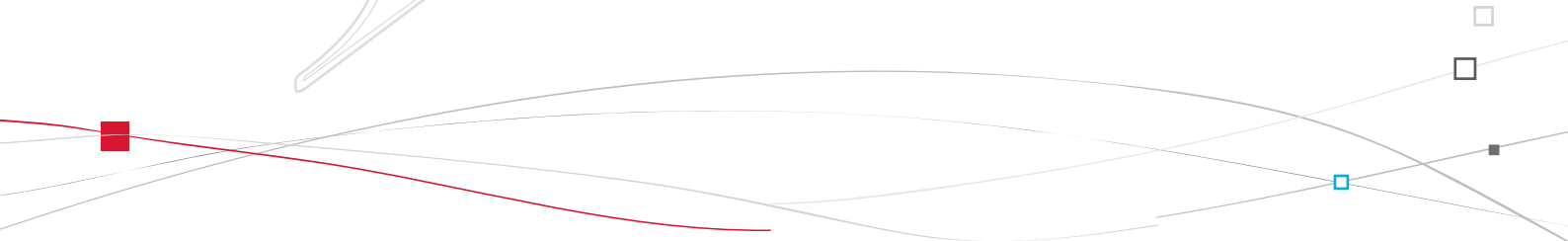



Front seats

Manual

1. Adjustments to the height and angle of the head restraint

To raise it, pull upwards.

To lower it, press on the lug and the head restraint at the same time.

2. Adjustment of the backrest angle

Turn the wheel to adjust the angle of the backrest.

3. Adjustment of the seat height

Raise or lower the control lever the number of times required to obtain the desired position.

4. Forwards-backwards adjustment of the seat position

Lift the control bar and slide the seat forwards or backwards.

5. Adjustment of the driver's lumbar support

Turn the wheel to obtain the desired level of lumbar support.

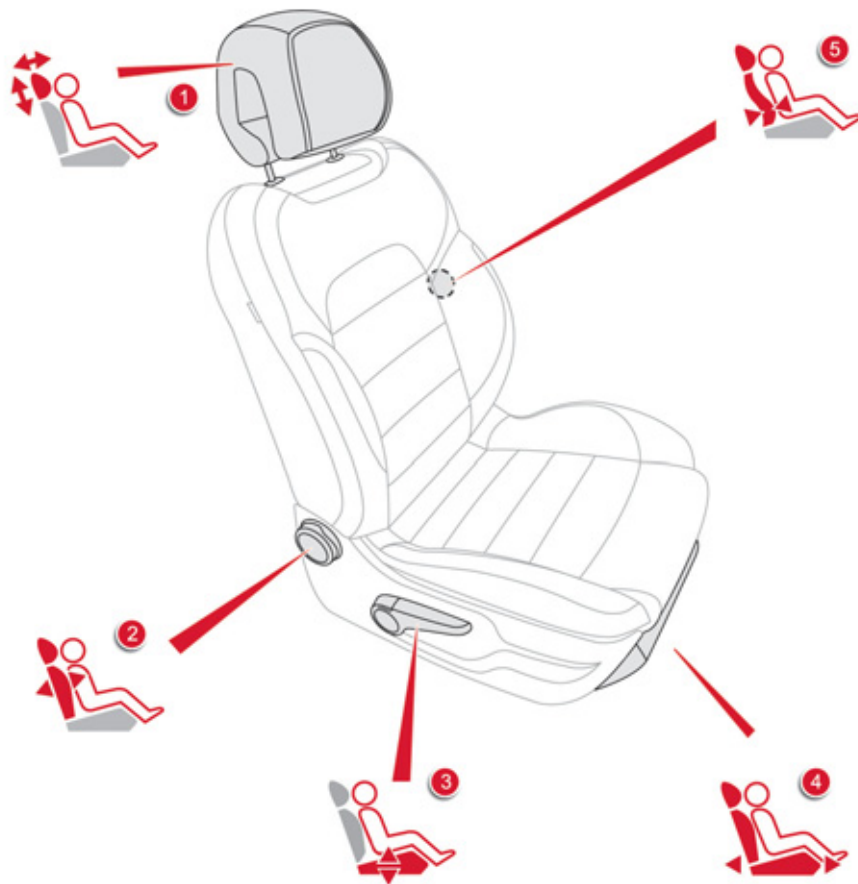



Electric

1. Adjustment of the seat cushion angle and height, and forwards-backwards adjustment

- ☞ Raise or lower the front of the control to adjust the seat cushion angle.
- ☞ Raise or lower the rear of the control to raise or lower the seat.
- ☞ Simultaneously raise or lower the front and rear of the control in order to raise or lower the entire seat.

2. Adjustment of the backrest angle

Move the control forwards or backwards to adjust the backrest angle.

3. Adjustment of driver's lumbar support

Press the control switches to obtain the desired level of lumbar support.

4. Manual adjustment of the cushion

Pull on the grip to adjust the length of the cushion.

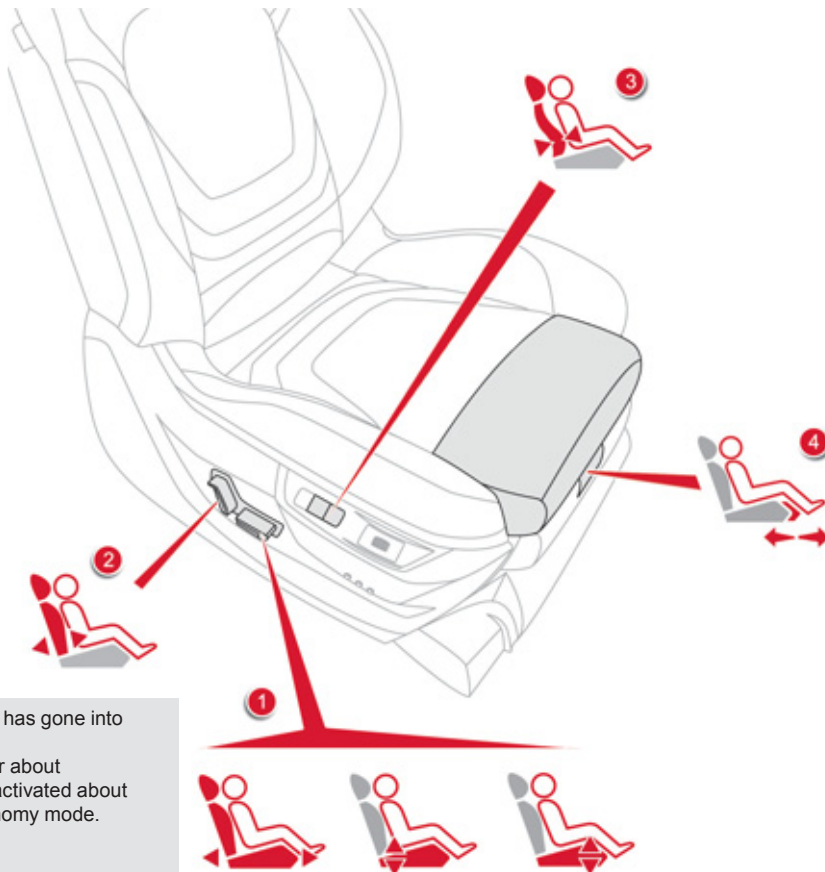

- i** Switch on the ignition or start the engine if the vehicle has gone into economy mode. The electric functions of the driver's seat are active for about 45 seconds after opening the front door. They are deactivated about 45 seconds after switching off the ignition and in economy mode. To reactivate them, switch on the ignition.

Storing driving positions

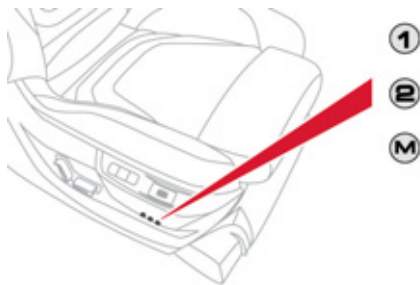

System which stores the electrical settings of the driver's seat and the head-up display settings. It enables you to store up to two positions using the buttons on the side of the driver's seat.

Storing a position using buttons M / 1 / 2

- ☞ Switch on the ignition.
- ☞ Adjust your seat and the head-up display.
- ☞ Press button **M**, then press button **1** or **2** within four seconds.
An audible signal indicates that the position has been stored.

Storing a new position cancels the previous position.

Recalling a stored position

- ☞ Briefly press button **1** or **2** to recall the corresponding position.
An audible signal indicates the end of the adjustment.

i You can interrupt the current movement by pressing button **M**, **1** or **2** or by using one of the seat controls.
A stored position cannot be recalled while driving.
Recalling stored positions is deactivated 45 seconds after switching off the ignition.

Head restraint height and angle adjustment

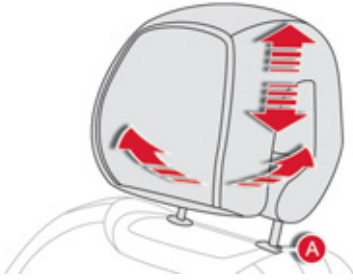

- ☞ To raise a head restraint, pull it upwards.
- ☞ To remove the head restraint, press the lug **A** and pull the head restraint upwards.
- ☞ To put the head restraint back in place, engage the head restraint stems in the openings keeping them in line with the seat back.
- ☞ To lower the head restraint, press the lug **A** and push down on the head restraint at the same time.
- ☞ To adjust the angle of the head restraint, tilt its lower part forwards or rearwards.

 The head restraint is fitted with a frame with notches which prevents it from lowering; this is a safety device in case of impact.

The adjustment is correct when the upper edge of the head restraint is level with the top of the head.

Never drive with the head restraints removed; they must be in place and adjusted correctly.

Heated seats control

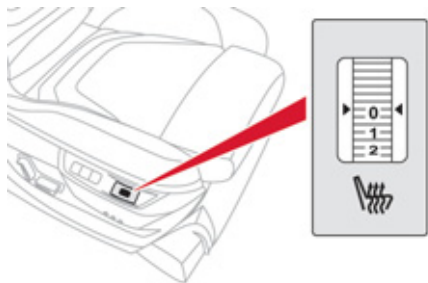

With the hybrid system active, the front seats can be heated individually.

☞ Use the adjustment wheel to switch on and select the level of heating required:

- 0: Off.
- 1: Low.
- 2: Medium.
- 3: High.

Massage function

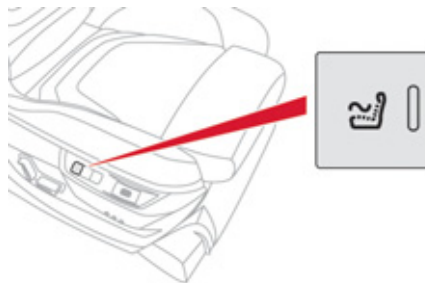

This function provides the driver with a back massage. It only operates when the hybrid system is active or in STOP mode of the Stop & Start system.

Activation



☞ Press this switch.

Its indicator lamp comes on and the massage function is activated for a period of 1 hour. During this time, massage is performed in 6 cycles of 10 minutes (6 minutes of massage followed by 4 minutes break). After one hour, the function is deactivated, the indicator lamp goes off.

Deactivation



You can deactivate the massage function at any time by pressing this switch, its indicator lamp goes off.

Rear seats

Bench seat with split cushion and backrest (left hand 2/3, right hand 1/3) which can be folded individually to adapt the load space in the boot.

Folding the cushion and backrest

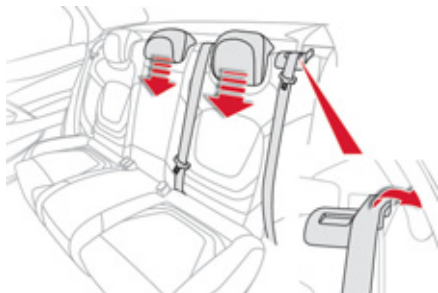

- ☞ Move the corresponding front seat forward if necessary.
- ☞ Place the head restraints in the low position or remove them.
- ☞ Remove the seat belt from its guide.

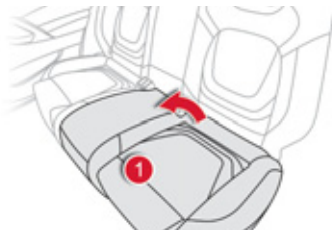

- ☞ Lift the cushion **1** by hand, lifting from the rear.

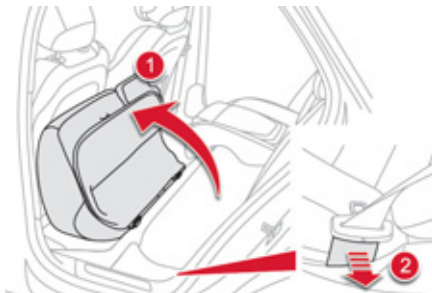

- ☞ Tip the seat cushion **1** fully against the front seat.
- ☞ Keep the seat belt guide **2** held against the vehicle.

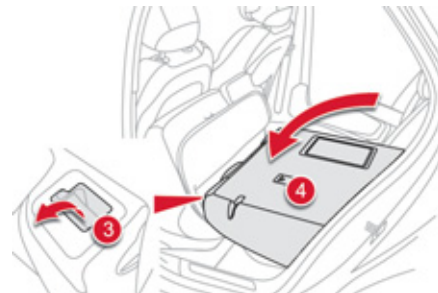

- ☞ Pull control **3** forwards to release the seat back **4**.
- ☞ Fold the seat backrest **4**.

Repositioning the seat backrest and cushion

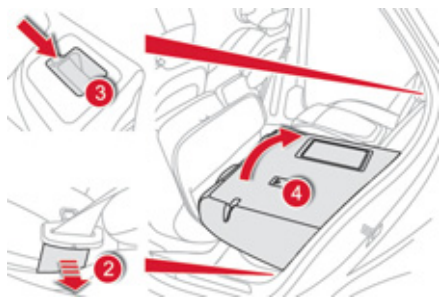

- ☞ Keep the seat belt guide **2** held against the vehicle to avoid trapping the seat belt when repositioning the seat.
- ☞ Straighten the seat back **4** while refitting the head restraints and secure it.
- ☞ Check that the red indicator, located next to the control **3**, is no longer visible.

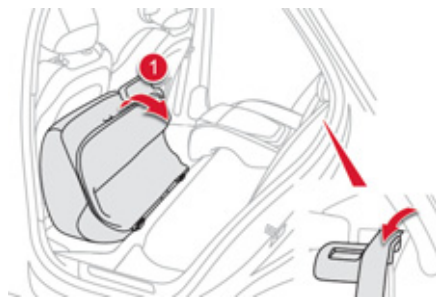

- ☞ Reposition the cushion **1**.
- ☞ Release the seat belt guide **2**.
- ☞ Put the seat belt back in place in the guide.

i When repositioning the seat backrest, take care not to trap the seat belts.

Removing the seat cushion

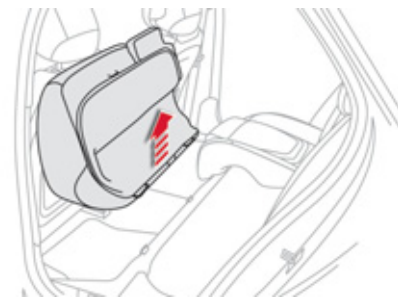

- ☞ Remove the seat cushion **1** from its fixings by pulling upwards.

Refitting the seat cushion

- ☞ Position the seat cushion **1** vertically in its fixings.

Fan cooling of the high voltage battery

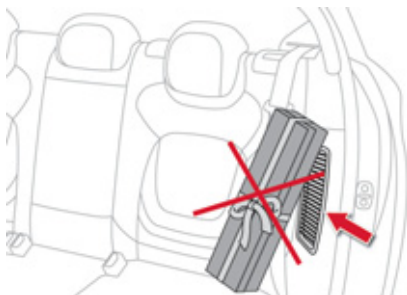

This system does not work continuously, but adapts the force of the fan cooling to the requirements of the battery. Its operation can be heard at the rear, even if the vehicle is stopped after a run. If the air intake is blocked, the battery may overheat, damaging the battery and causing a loss of performance of the hybrid system.

- !** For the best use of the high voltage battery, please follow these recommendations:
- do not obstruct the air intake with loose articles, otherwise, the battery may overheat, causing a loss of performance of the hybrid system
 - do not spill fluids, as this may cause damage to the battery.

i The high voltage battery has an air cooling system, comprising an air intake (located on the side of the left hand rear seat) and a fan (located behind the left hand boot trim panel).

Rear head restraints

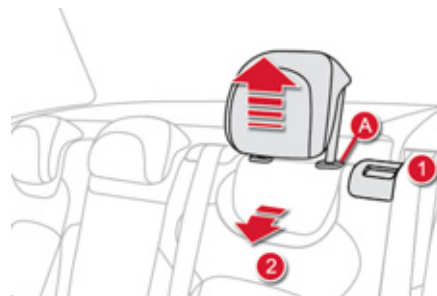

These have one position for use (up) and a stowed position (down).

They can also be removed.

To remove a head restraint:

- ☞ release the backrest using control **1**,
- ☞ tilt the backrest **2** slightly forwards,
- ☞ pull the head restraint upwards to the stop,
- ☞ then, press the lug **A**.

! Never drive with the head restraints removed; they must be in place and correctly adjusted.

Mirrors

Door mirrors

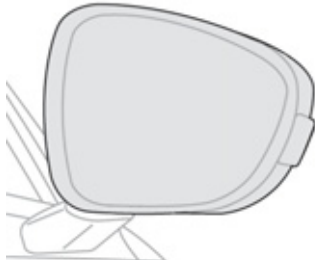

Each fitted with an adjustable mirror glass providing the lateral rearward vision necessary for overtaking or parking. They can also be folded for parking in confined spaces.

Demisting - Defrosting



Demisting-defrosting of the door mirrors operates by switching on the heated rear screen.

For more information, refer to the "Rear screen demist-defrost" section.



The rear screen demisting - defrosting can only operate when the hybrid system is active.

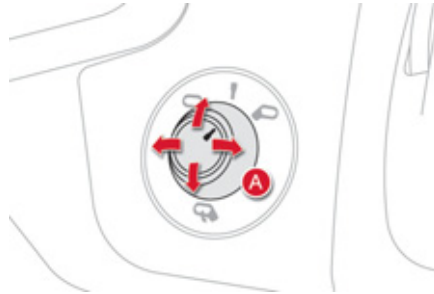

Adjustment

- ☞ Turn control **A** to the right or to the left to select the corresponding mirror.
- ☞ Move control **A** in all four directions to adjust.
- ☞ Return control **A** to the central position.



The objects observed are, in reality, closer than they appear. Take this into account in order to correctly judge the distance of vehicles approaching from behind.

Folding

Automatic: lock the vehicle using the electronic key.



Manual: with the ignition on, move control **A** downwards.



If the mirrors are folded using control **A**, they will not unfold when the vehicle is unlocked.

Unfolding

Automatic: unlock the vehicle using the electronic key.



Manual: with the ignition on, move control **A** upwards.



The folding and unfolding of the door mirrors using the electronic key can be deactivated by a CITROËN dealer or a qualified workshop. Fold the mirrors when putting your vehicle through an automatic car wash.

Rear view mirror

Adjustable mirror providing a central rearward view.

Equipped with an anti-dazzle system, which darkens the mirror glass and reduces the nuisance to the driver caused by the sun, headlamps from other vehicles...

Automatic day/night model

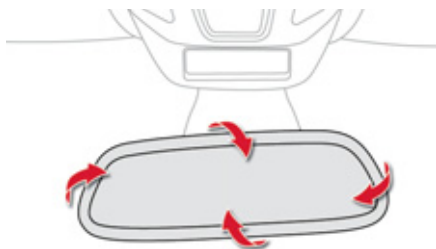

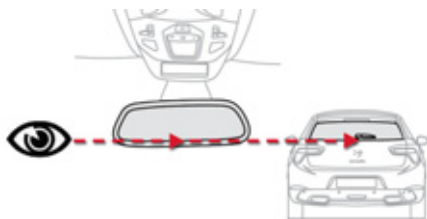

By means of a sensor, which measures the light from the rear of the vehicle, this system automatically and progressively changes between the day and night uses.

Seeing clearly







For better rear vision, align the bottom of the rear view mirror with the bottom of the rear screen.

 In order to ensure optimum visibility during your manoeuvres, the mirror lightens automatically when reverse gear is engaged.

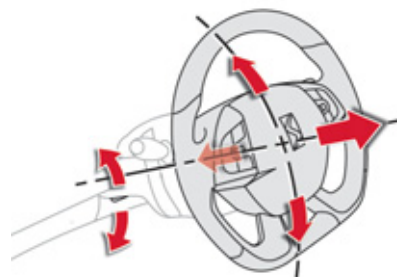
 As a safety measure, the mirrors should be adjusted to reduce the "blind spot".

Steering wheel adjustment



-  **When stationary**, pull the control lever to release the adjustment mechanism.
-  Adjust the height and reach to suit your driving position.
-  Push the control lever to lock the adjustment mechanism.

 As a safety precaution, these operations should only be carried out while the vehicle is stationary.

Interior fittings

- 1. Glove box**
- 2. Storage**
- 3. Storage (according to version)**
- 4. Ticket holder (according to version)**
- 5. Removable ashtray / 12 V accessory socket (120 W)**
Press the lid to open the ashtray.
To empty the ashtray, remove it by pulling it upwards.
- 6. Front armrest and storage**
It is illuminated, cooled and contains storage space (1.5 litre bottle, ...).
- 7. USB Player**
- 8. 12 V accessory socket (120 W)**
Observe the maximum power rating to avoid damaging your accessory
- 9. Cup holder in the door panel.**

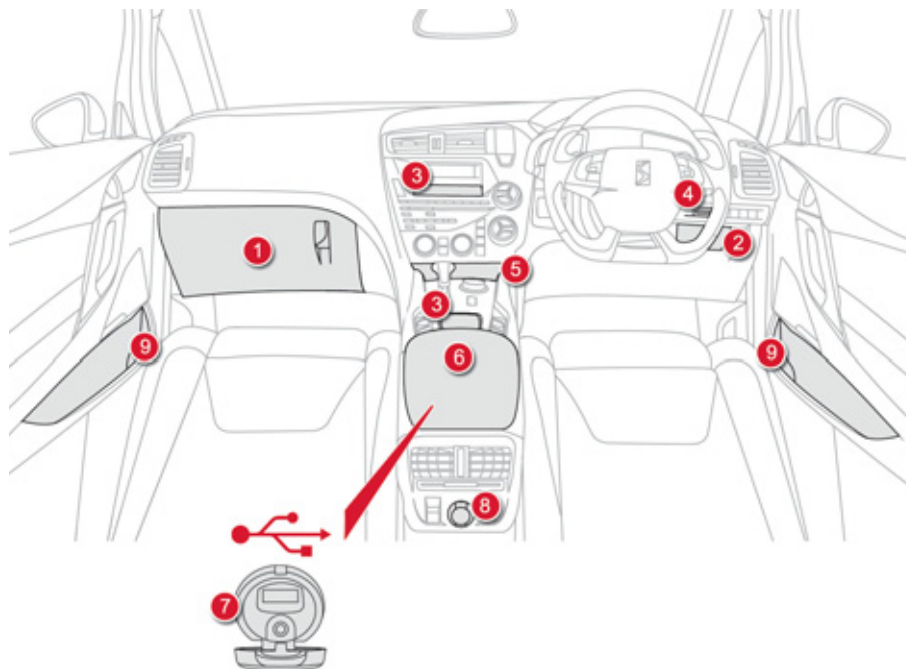

Cigarette lighter / 12 V accessory socket

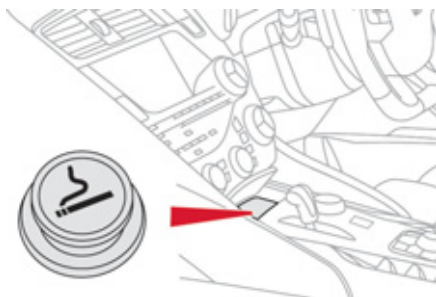

- ☞ To use the cigarette lighter, press it in and wait a few seconds until it pops out automatically.
- ☞ To connect a 12 V accessory (max power: 120 W), remove the cigarette lighter and connect a suitable adaptor.

You can use this socket to connect a telephone charger, a bottle warmer...

After use, put the cigarette lighter back into place straight away.

Mats

Removable carpet protection.

Fitting

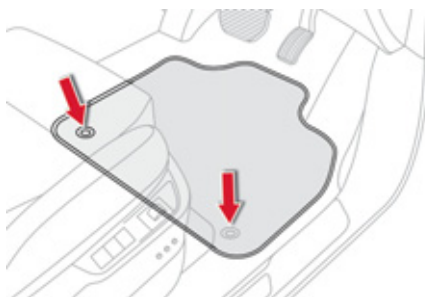

- ☞ move the seat fully back,
- ☞ fit the mat in place,
- ☞ engage the fixings by pressing down on them.

Removal

To remove the mat on the driver's side:

- ☞ move the seat fully back,
- ☞ disengage the fixings, leaving the fixing pins in the floor carpet,
- ☞ remove the mat.

Refitting

To refit the mat on the driver's side:

- ☞ position the mat correctly,
- ☞ refit the fixings by pressing,
- ☞ check that the mat is secured correctly.



To avoid any risk of jamming of the pedals:

- only use mats which are suited to the fixings already present in the vehicle; these fixings must be used,
- never fit one mat on top of another.

The use of mats not approved by CITROËN may interfere with access to the pedals and hinder the operation of the cruise control / speed limiter.

Centre armrest

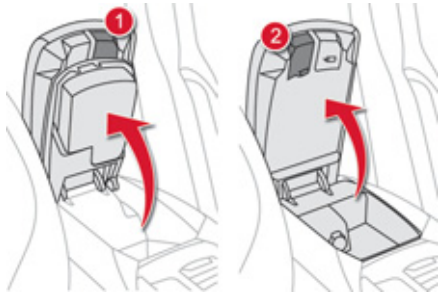

Comfort and storage system for the driver and front passenger.

Storage

- ☞ For access to the large storage box, press button **1** then lift the cover.
- ☞ For access to the small storage box (below the armrest cover) press button **2** then lift the cover.

These can be used for portable devices (mobile phone, MP3 player...) which can be connected to the USB port / auxiliary socket.

An air vent (with adjustable opening) delivers cooled air into the large storage box.

USB Player



This connection box, consisting of a JACK auxiliary socket and a USB port, is located in the front armrest (under the cover).

It permits the connection of portable device, such as a digital audio player of the iPod® type or a USB memory stick.

It reads the audio file formats (MP3, OGG, WMA, WAV, ...) which are transmitted to your audio equipment and played via the vehicle's speakers.

You can manage these files using the steering mounted controls or the audio system control panel and display them in the instrument panel screen.

When the USB port is used, the portable device charges automatically.

i For more information on the use of this system, refer to the "Audio and telematics" section.



Rear armrest

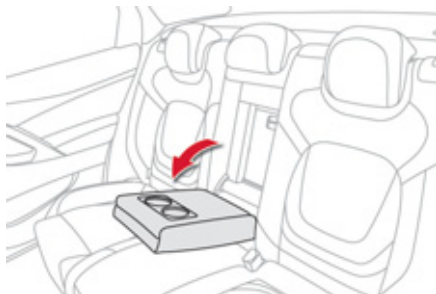

- ☞ Lower the rear armrest for a more comfortable position. It may be fitted with cup holders and also gives access to the ski flap.

Ski flap

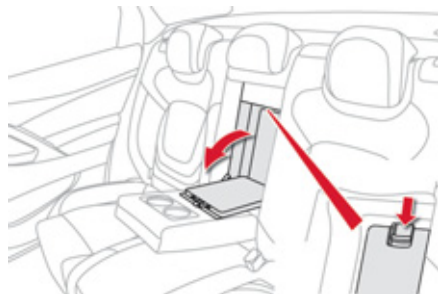

Facility for storing and transporting long objects.

Opening

- ☞ Lower the armrest.
- ☞ Press the flap opening control.
- ☞ Lower the flap.
- ☞ Load the objects from inside the boot.

Boot fittings

1. Rear parcel shelf

It can be removed for carrying large objects.

2. Bag hooks

3. Warning triangle retaining straps

4. Removable boot floor

Lift the floor using the grip and follow the guides.

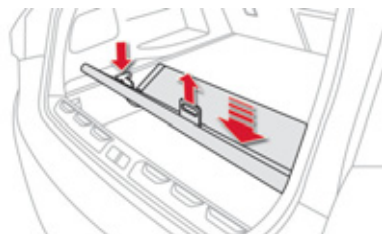
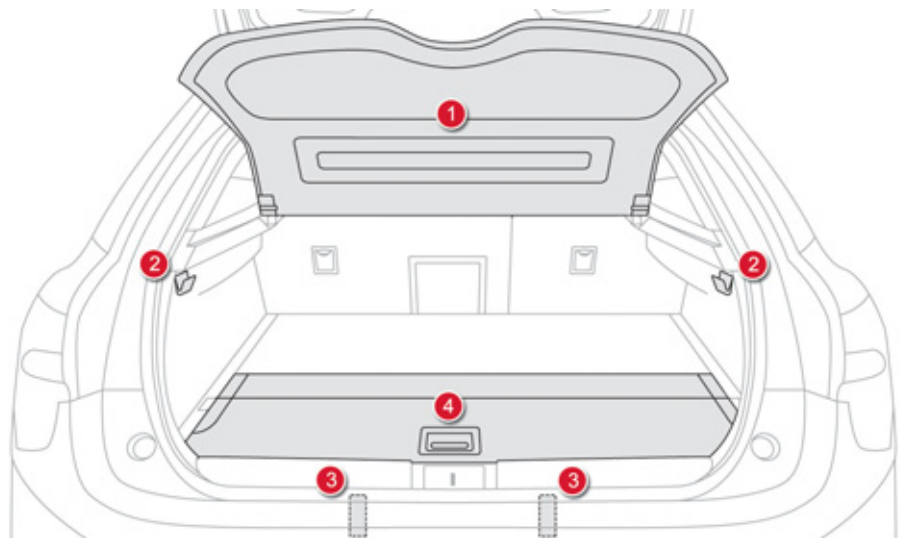

Warning triangle (stowing)

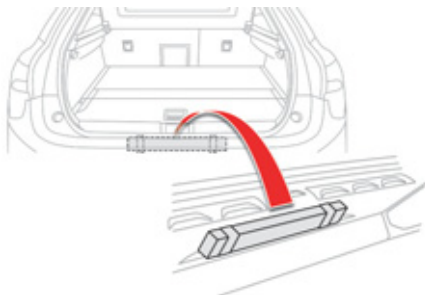

Use the straps on the interior boot trim to stow the folded triangle or its storage box.



Refer to the manufacturer's instructions for use of the triangle.

Placing the triangle in the road

- Place the triangle at a distance behind the vehicle, as shown in the table below, according to the type of road and the level of ambient light.

Distance from your vehicle (in metres)		
Road		Motorway
Day	Night	
50 m	80 m	150 m

! Before getting out of your vehicle to assemble the triangle and place it on the road, put on your high visibility vest.

i The triangle is available as an accessory, contact a CITROËN dealer or a qualified workshop.

These are the internationally recognised values.
Use the triangle in line with local driving regulations.

Heating and Ventilation

System which creates and maintains good conditions of comfort and visibility in the vehicle's passenger compartment.

Controls

The incoming air follows various routes depending on the controls selected by the driver, the front passenger and rear passengers.

The temperature control enables you to obtain the level of comfort required by mixing the air of the various circuits.

The air distribution control enables you to select the air vents used in the passenger compartment by the combined use of the associated buttons.

The air flow control enables you to increase or reduce the speed of the ventilation fan.

These controls are grouped together on control panel **A** on the centre console.

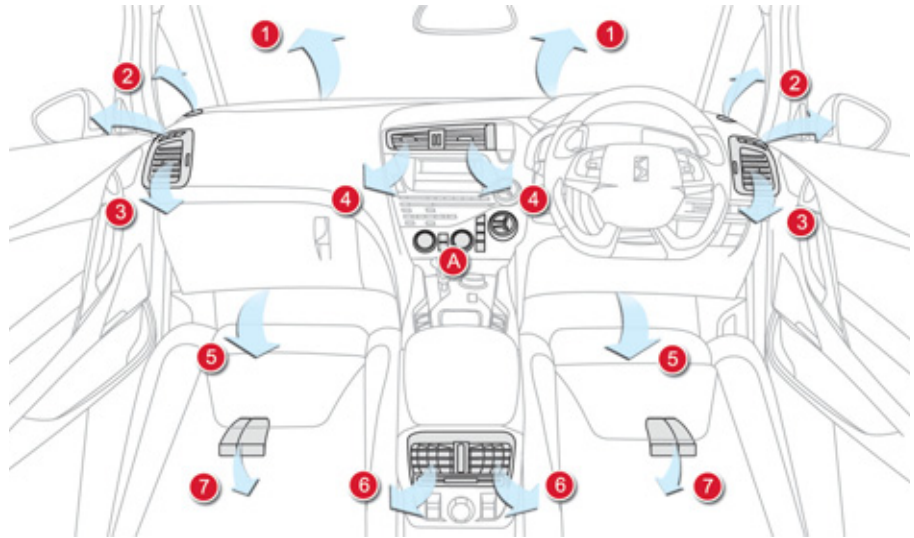

Air distribution

1. Windscreen demisting/defrosting vents.
2. Front side quarter light window demisting/defrosting vents.
3. Side adjustable air vents.
4. Central adjustable air vents.
5. Air outlets to the driver and front passenger footwells.
6. Adjustable air vents for the rear passengers.
7. Air outlets to the rear footwells.





Recommendations for ventilation and air conditioning

-  In order for these systems to be fully effective, follow the operation and maintenance guidelines below:
- ☞ To obtain an even air distribution, take care not to obstruct the exterior air intake grilles located at the base of the windscreen, the nozzles, the vents and the air outlets, as well as the air extractor located in the boot.
 - ☞ Do not cover the sunshine sensor, located on the dashboard; this is used for regulation of the digital air conditioning system.
 - ☞ Operate the air conditioning system for at least 5 to 10 minutes, once or twice a month to keep it in perfect working order.
 - ☞ Ensure that the passenger compartment filter is in good condition and have the filter elements replaced regularly (refer to the "Checks" section).
We recommend the use of a combined passenger compartment filter. Thanks to its special active additive, it contributes to the purification of the air breathed by the occupants and the cleanliness of the passenger compartment (reduction of allergic symptoms, bad odours and greasy deposits).
 - ☞ To ensure correct operation of the air conditioning system, you are also advised to have it checked regularly as recommended in the servicing and warranty booklet.
 - ☞ If the system does not produce cold air, switch it off and contact a CITROËN dealer or a qualified workshop.

You can switch off the air conditioning (AC button) and stay in Automatic mode in order to limit fuel consumption. If misting appears while in this mode, you can switch the air conditioning back on temporarily to improve the situation.

When towing the maximum load on a steep gradient in high temperatures, switching off the air conditioning increases the available engine power and so improves the towing ability.

-  If after an extended stop in sunshine, the interior temperature is very high, first ventilate the passenger compartment for a few moments.
Put the air flow control at a setting high enough to quickly change the air in the passenger compartment.
The air conditioning system does not contain chlorine and does not present any danger to the ozone layer.

-  The condensation created by the air conditioning results in a discharge of water under the vehicle which is perfectly normal.

Dual-zone digital air conditioning

The air conditioning can only operate when the hybrid system is active (Ready lamp on). Its effectiveness will be reduced when in electric mode (see the ECO OFF section).

Automatic operation

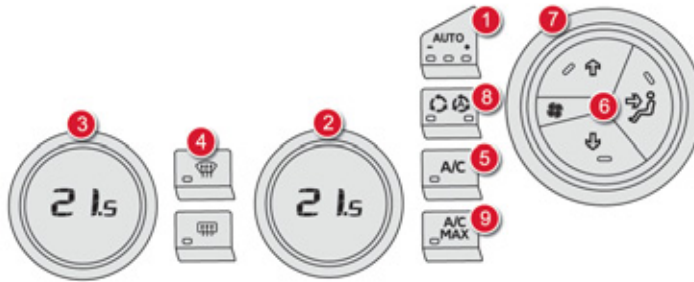

1. Automatic comfort programme



We recommend the use of one of the three AUTO modes available: they provide optimised regulation of the temperature according to the comfort value that you have chosen.

These three modes automatically control the system, according to the desired setting, while also maintaining the desired comfort value.

This system is designed to operate effectively in all seasons, with the windows closed.

- ☞ Press the **"AUTO"** button repeatedly:
 - a first indicator lamp comes on; the "low" setting mode is selected,
 - a second indicator lamp comes on; the "medium" setting mode is selected,
 - a third indicator lamp comes on; the "high" mode setting is selected.
- Use the "medium" and "high" settings in preference to maintain the comfort level at the rear.

i When the engine is cold, the air flow will reach its optimum level progressively, taking account of the weather and the desired comfort level so as to avoid too great a distribution of cold air.

On entering the vehicle, if the interior temperature is much colder or warmer than the comfort value, there is no need to change the value displayed in order to obtain the comfort required. In all seasons, with the windows closed the system corrects the difference in temperature automatically and as quickly as possible.



2-3. Driver's-passenger's side settings



The driver and front passenger can each adjust the temperature to their requirements.

The value indicated on the display corresponds to a level of comfort and not to a temperature in degrees Celsius or Fahrenheit.

- ☞ Turn control **2** or **3** to the left or to the right respectively to decrease or increase this value.

A setting around the value 21 provides optimum comfort. However, depending on your requirements, a setting between 18 and 24 is normal.

You are advised to avoid a left / right setting difference of more than 3.

4. Automatic visibility programme



See "Front demisting - defrosting".

-  With Stop & Start, when demisting has been switched on, the Diesel engine does not stop.

Manual operation

If you wish, you can make a different choice from that offered by the system by changing a setting. The **"AUTO"** indicator lamps go off; the other functions, except the air conditioning, will still be controlled automatically.

- ☞ Pressing the **"AUTO"** button returns the system to completely automatic operation.

-  For maximum cooling or heating of the passenger compartment, it is possible to exceed the minimum value 14 or the maximum value 28.

- ☞ Turn control **2** or **3** to the left until **"LO"** is displayed or to the right until **"HI"** is displayed.

5. Air conditioning On / Off





☞ Press this button to switch off the air conditioning.

Switching the system off could result in discomfort (humidity, condensation).

☞ Press this button again to return to automatic operation of the air conditioning. The indicator lamp in the "A/C" button comes on.

To obtain cool air more quickly, you can use recirculation of the interior air for a few moments. Then revert to the intake of exterior air.

 In ZEV mode, the hybrid system may temporarily inhibit operation of the air conditioning.

 The **ZEV** mode gives preference to electric driving rather than maintaining a comfortable temperature.

6. Air distribution adjustment



☞ Press one or more buttons to direct the air flow towards:

- the windscreen and side windows,
- the outer and centre air vents,
- the footwells.

You can combine the three orientations to obtain the desired air distribution.

7. Air flow adjustment



☞ Turn this control to the left to decrease the air flow or to the right to increase the air flow.

The air flow indicator lamps, between the two fans, come on progressively in relation to the value requested.

8. Air intake / Air recirculation

Air recirculation enables the passenger compartment to be isolated from exterior odours and smoke when external pollution is detected (if your vehicle is fitted with a pollution sensor). It is activated automatically on operation of the screenwash.

It is inactive when the ambient temperature is below 5 °C to avoid the risk of misting in the vehicle.



- The indicator lamp with "A" on indicates that recirculation is controlled automatically.
- The indicator lamp without "A" on indicates that recirculation is forced manually.
- Both indicator lamps off indicates that recirculation is controlled automatically without taking account of the detection of pollution.

Without pollution sensor



If your vehicle is not fitted with a pollution sensor, press this button to force recirculation manually.



9. Maximum air conditioning



- ☞ If you want to quickly cool the air in the passenger compartment, press this button; **"LO"** is displayed.

To return to the previous settings, press the button again.

Switching the system off



- ☞ Turn the air flow control to the left until all of the indicator lamps go off.

This action switches off the air conditioning and the ventilation.

Temperature related comfort is no longer assured but a slight flow of air, due to the movement of the vehicle, can still be felt.

- ☞ Modify the settings (temperature, air flow or air distribution) or press the **"AUTO"** button to reactivate the system with the values set before it was switched off.



Avoid prolonged operation in interior air recirculation mode or driving for long periods with the system off (risk of condensation and deterioration of air quality).

Front Demist - Defrost

Automatic visibility programme



- Select this programme to demist or defrost the windscreen and side windows as quickly as possible.

The system automatically manages the air conditioning, air flow and air intake, and provides optimum distribution towards the windscreen and side windows.

- To stop the programme, press either the **"visibility"** button again or **"AUTO"**, the indicator lamp in the button goes off and the indicator lamp in the **"AUTO"** button comes on.

The system starts again with the values in use before it was overridden by the visibility programme.

 With Stop & Start, when demisting has been activated, the STOP mode is not available.

Rear screen and door mirrors demist - defrost

Switching on

The rear screen demisting - defrosting can only operate when the hybrid system is active.



- Press this button (located on the air conditioning system control panel) to demist/defrost the rear screen and the door mirrors. The indicator lamp associated with the button comes on.

Switching off

The demisting/defrosting switches off automatically to prevent an excessive consumption of current.



- It is possible to stop the demisting/defrosting operation before it is switched off automatically by pressing the button again. The indicator lamp associated with the button goes off.



- Switch off the demisting/defrosting of the rear screen and door mirrors as soon as appropriate, as lower current consumption results in reduced fuel consumption.



004
Driving

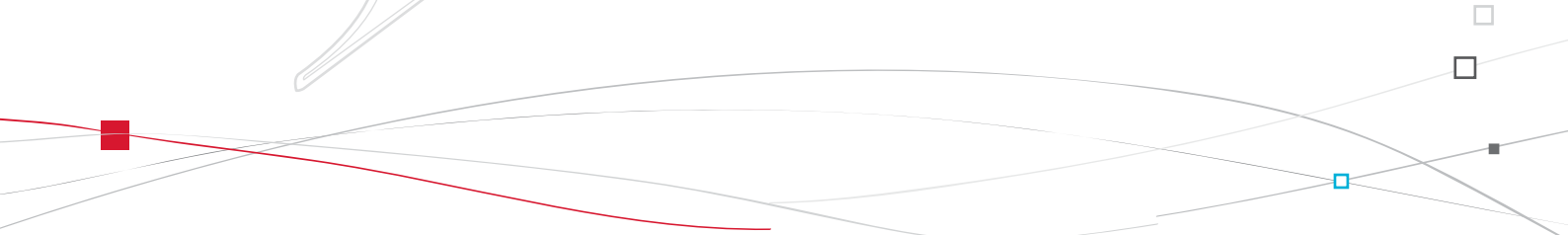



Electric parking brake

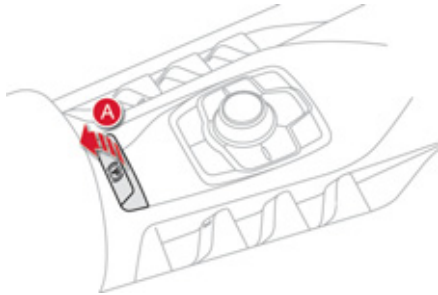

The electric parking brake combines 2 operating modes:

- **Automatic Application/Release**
Application is automatic when the engine stops, release is automatic on use of the accelerator (this mode is activated by default),
- **Manual Application/Release**
Manual application of the parking brake is done by pulling control lever **A**. Manual release is done by **pulling** then releasing the control lever, while pressing the brake pedal

When the driver's door is opened, there is an audible signal and a message is displayed if the brake is not applied.

Programming the automatic mode

Depending on the country of sale of the vehicle, the automatic application when the engine is switched off and the automatic release when you press the accelerator can be deactivated. You can contact a CITROËN dealer or a qualified workshop to have it activated.



In this case, programming is done via the configuration menu.



If deactivated, the parking brake must be applied and released manually. If this warning lamp comes on in the instrument panel, the automatic mode is deactivated.

Label on door panel



It is recommended that you do not apply the parking brake in very cold conditions (ice) and during towing (recovery...).

To do this, release the parking brake manually, select position **A** or **R**, then press the START/STOP switch to stop the engine.



Never leave the vehicle without checking that the parking brake is on.



This warning lamp comes on fixed (not flashing).

Manual application

With the vehicle stationary, to apply the parking brake whether the hybrid system is active or not, **pull** control lever **A**.

The application of the parking brake is confirmed by:

- illumination of the braking warning lamp and of the **P** warning lamp in the control lever **A**,
- the display of a message.

When the driver's door is opened with the hybrid system active, there is an audible signal and a message is displayed if the parking brake has not been applied.

- i** Before leaving the vehicle, check that parking brake warning lamps in the instrument panel and the control lever **A** are on fixed, not flashing.

Manual release

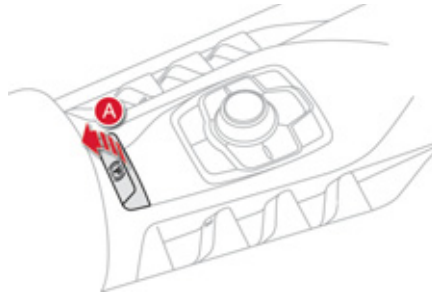

With the ignition on or the hybrid system active, to release the parking brake, **press the brake pedal, pull** then release control lever **A**. The full release of the parking brake is confirmed by:

- the braking warning lamp and the **P** warning lamp in the control lever **A** going off,
- the display of a message.

If you pull the control lever **A** without pressing the brake pedal, the parking brake will not be released and a message appears in the instrument panel.

Maximum application

If necessary, you can make a **maximum application** of the parking brake. It is obtained by means of a **long pull** on control lever **A**, until you see a message and an audible signal is heard.

Maximum application is essential:

- in the case of a vehicle towing a trailer, if the automatic functions are activated but you are applying the parking brake manually,
- when the slope you are parked on may vary (e.g. on a ferry, on a lorry, during towing).

- i** In the case of towing, a loaded vehicle or parking on a gradient, make a maximum application of the parking brake then turn the front wheels towards the pavement and engage a gear when you park. After a maximum application, the release time will be longer.

Automatic application, engine off

With the vehicle stationary, the parking brake is **automatically applied when the engine is switched off**.

The application of the parking brake is confirmed by:

-  - illumination of the braking warning lamp and of the **P** warning lamp in the control lever **A**,
- the display of a message.

 Before leaving the vehicle, check that parking brake warning lamps in the instrument panel and in the control lever **A** are on fixed (not flashing). Never leave a child alone inside the vehicle with the ignition on, as they could release the parking brake.

Automatic release

The electric parking brake **releases automatically and progressively as the vehicle moves off**, select position **A**, **M** or **R** and then press the accelerator.

-  Full release of the parking brake is confirmed by:
 - the braking warning lamp and the **P** warning lamp in the control lever **A** going off,
 - the display of a message.

 When stationary, with the hybrid system activated, do not press the accelerator pedal unnecessarily, as you may release the parking brake.

Immobilising the vehicle, hybrid system active

With the hybrid system active and the vehicle stationary, in order to immobilise the vehicle it is essential to **manually** apply the parking brake by **pulling** control lever **A**.

The application of the parking brake is confirmed by:

-  - illumination of the braking warning lamp and of the **P** warning lamp in the control lever **A**,
- the display of a message.

When the driver's door is opened, a loud beep is heard and a message is displayed if the parking brake has not been applied.

 Before leaving the vehicle, check that parking brake warning lamps in the instrument panel and the control lever **A** are on fixed, not flashing.

Emergency braking

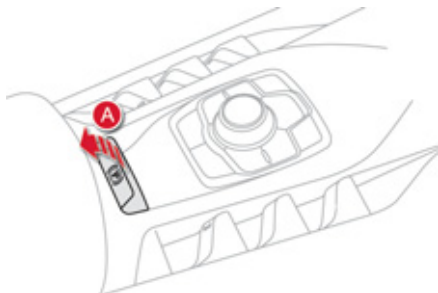

In the event of a failure of the main service brake or in an exceptional situation (e.g. driver taken ill, under instruction, etc) a continuous pull on the control lever **A** will stop the vehicle. The Dynamic Stability Control system provides stability during emergency braking. If the emergency braking malfunctions, a message is displayed.



If a failure of the DSC system is signalled by the illumination of this warning lamp, then braking stability is not guaranteed.

In this event, stability must be assured by the driver by repeating alternate "pull-release" actions on the control lever **A**.

Emergency release

In the event of the electric parking brake malfunctioning or the battery running flat, an emergency manual device can release the parking brake.

- ☞ Immobilise the vehicle and with the hybrid system active, place the gear selector in position **M** or **R**.
- ☞ Switch off the engine then switch the ignition back on (press the START/STOP switch twice). If it is impossible to immobilise the vehicle, do not operate the control and contact a CITROËN dealer or a qualified workshop urgently.



The emergency braking must only be used in exceptional circumstances.

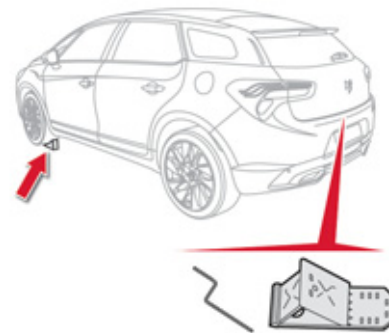

- ☞ Take the vehicle blocks and the release device, located under the boot carpet.
- ☞ On sloping ground, secure the vehicle by placing chocks in front or behind the front wheels, on the falling side of the slope.

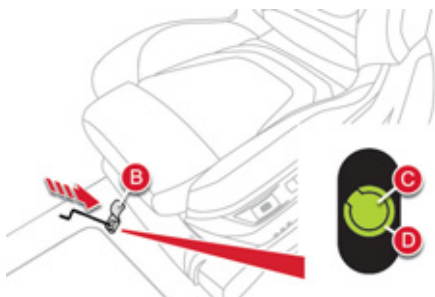

Front left seat moved back fully.

- ☞ Slide the front left-hand seat back as far as possible.
- ☞ Raise the pre-cut zone **B** in the carpet under the seat.
- ☞ Pierce the protective cover **C** on the tube **D** with the release device (located in the boot).
- ☞ Place the release device in the tube **D**.
- ☞ Turn the release device **clockwise** making several dozen turns

For safety reasons, it is **essential** to continue turning the device as far as it will go. The parking brake is released.



- ☞ Remove the release device and stow it.
- ☞ The operation of the parking brake reinitialises after the ignition is switched off then on again. If the reinitialisation of the parking brake proves impossible, contact a CITROËN dealer or a qualified workshop.
- ☞ The (subsequent) time required for application may be longer than during normal operation.





! For safety reasons, you must contact a CITROËN dealer as soon as possible to replace the protective cover. Take care not to allow moisture or dust in the proximity of the protective cover. Following an emergency unlocking, immobilisation of the vehicle is no longer guaranteed once the manual emergency release has been deployed and the manual control does not allow the re-application of your parking brake. Take no action, either on the control lever **A**, or stopping or starting the engine while the release device is engaged. To re-engage the electric parking brake (after correction of the fault or battery problem), make a long pull on the control lever **A** until the parking brake warning lamp in the instrument panel flashes then make a second long pull until this warning lamp comes on fixed.



Operating faults

If the electric parking brake fault warning lamp comes on together with one or more of the warning lamps presented in these tables, place the vehicle in a safe condition (on level ground, gear engaged) and contact a CITROËN dealer or a qualified workshop without delay.

Situations	Consequences
<p>Display of the message "Parking brake fault" and of the following warning lamps:</p> 	<ul style="list-style-type: none"> - The automatic functions are deactivated. - Hill start assist is not available. - The electric parking brake can only be used manually.
<p>Display of the message "Parking brake fault" and of the following warning lamps:</p> 	<ul style="list-style-type: none"> - Manual release of the electric parking brake is only possible by pressing the accelerator pedal and pulling the control lever. - Hill start assist is not available. - The automatic functions and the manual application are still available.
<p>Display of the message "Parking brake fault" and of the following warning lamps:</p> 	<ul style="list-style-type: none"> - The automatic functions are deactivated. - Hill start assist is not available.

Situations	Consequences
 <p>and possibly</p>  <p>flashing</p>	<p>To apply the electric parking brake:</p> <ul style="list-style-type: none"> ☞ immobilise the vehicle and switch off the ignition. ☞ pull the control for at least 5 seconds or until application is complete. ☞ switch on the ignition and check that the electric parking brake warning lamps come on. <p>The application is slower than during normal operation.</p> <p>To release the electric parking brake:</p> <ul style="list-style-type: none"> ☞ switch on the ignition. ☞ pull the control lever and hold it for approximately 3 seconds then release it. <p>If the braking warning lamp is flashing or if the warning lamps do not come on with the ignition on, these procedures will not work. Place the vehicle on level ground and have it checked by a CITROËN dealer or a qualified workshop.</p>
<p>Display of the message "Parking brake fault" and of the following warning lamps:</p>  <p>and possibly</p>  <p>flashing</p>	<ul style="list-style-type: none"> - Only the automatic application on switching off the engine and automatic release on acceleration functions are available. - The manual application/release of the electric parking brake and the emergency braking are not available.
<p>Display of the message "Battery charge fault".</p> 	<ul style="list-style-type: none"> - You must stop as soon as it is safe to do so. Switch off and immobilise your vehicle (if necessary, place the a chock under a wheel). - Apply the electric parking brake before switching off the engine.



Special situations

In some circumstances (engine start...), the parking brake may adjust the level of application itself. This is normal operation. To move your vehicle a few centimetres without starting the engine, with the ignition on, press the brake pedal and release the parking brake **by pulling** then **releasing** the control lever **A**. Complete release of the parking brake is indicated by the warning lamps in the control lever **A** and in the instrument panel going off and by the display of the message "Parking brake off".

In the event of a malfunction of the parking brake **in the on position** or a battery failure, manual release remains possible. To ensure correct operation, and so your safety, the number of successive applications and releases of the parking brake is limited to eight cycles. If used excessively, you are alerted by the message "parking brake faulty" and a flashing warning lamp.

Hill start assist

System which keeps your vehicle immobilised temporarily (approximately 2 seconds) when starting on a gradient, the time it takes to move your foot from the brake pedal to the accelerator pedal.

This function is only active when:

- the vehicle is completely stationary, with your foot on the brake pedal,
- in particular conditions on a slope,
- with the driver's door closed.

The hill start assist function cannot be deactivated.

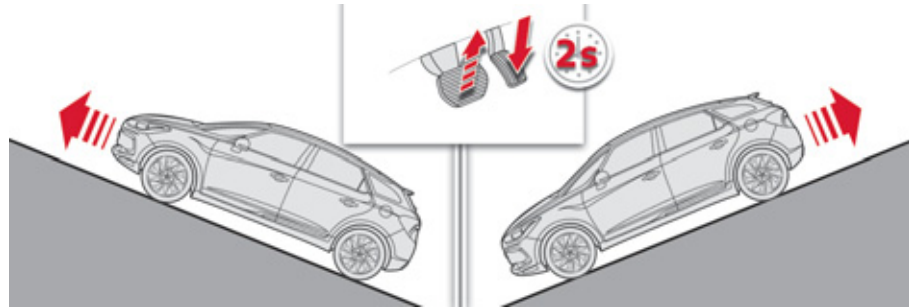

On an ascending slope, with the vehicle stationary, the vehicle is held for a brief moment when you release the brake pedal, if the gear selector is in position A or M.

On a descending slope, with the vehicle stationary and reverse gear engaged, the vehicle is held for a brief moment when you release the brake pedal.



Do not exit the vehicle while it is being held in the hill start assist phase.

If you need to exit the vehicle with the hybrid system active, apply the parking brake manually then ensure that the parking brake warning lamp and the warning lamp **P** on the lever (of the electric brake) are permanently on.

Operating fault



SERVICE

If a malfunction of the system occurs, these warning lamps come on. Contact a CITROËN dealer or a qualified workshop to have the system checked.

6-speed electronic gearbox

Six-speed electronic gearbox which offers a choice between the comfort of fully automatic operation or the pleasure of manual gear changing.

There are two driving modes:

- **automated** mode for automatic control of the gears by the gearbox,
- **manual** mode for sequential gear changing by the driver.

In automated mode, it remains possible to change gear manually by using the steering mounted control paddles as desired, when overtaking, for example.

This gearbox provides additional functions:

- hill start assist,
- creep function (the vehicle moves on its own on releasing the brake pedal) in automated mode or in reverse.

Gear selector



- R.** Reverse.
 - ☞ With your foot on the brake, lift the selector and push forwards.
- N.** Neutral.
 - ☞ With your foot on the brake, select this position to start.
- A.** Automated mode.
 - ☞ Move the selector backwards to select this mode.
- M.** Manual mode with sequential gear changing.
 - ☞ Lift the selector then move it backwards to select this mode, then use the steering mounted control paddles to change gear.

Steering mounted control paddles

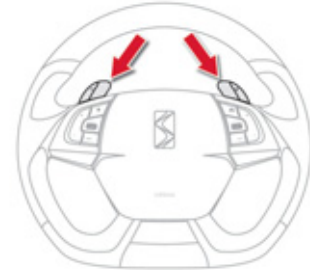

- +** Change up paddle to the right of the steering wheel.
 - ☞ Press the back of the "+" steering mounted paddle to change up a gear.
- Change down paddle to the left of the steering wheel.
 - ☞ Press the back of the "-" steering mounted paddle to change down a gear.

i The steering mounted paddles cannot be used to select neutral or to engage or disengage reverse gear.

Displays in the instrument panel



N Neutral

R Reverse

1, 2, 3, 4, 5, 6 Gears in manual mode

A This comes on when automated mode is selected. It goes off on changing to manual mode.



- ☞ Place your **foot on the brake** when a message appears in the instrument panel screen.



Engagement of reverse gear is accompanied by an audible signal. If you leave the vehicle, place the gear selector in position **N** and then you must stop the hybrid system by switching off the ignition (**Ready** lamp off).

Moving off

- ☞ Select position **N**.
- ☞ Press the brake pedal down fully.
- ☞ Start the hybrid system.



N appears in the instrument panel screen.



If the gear selector is not in position **N** on starting, **N** flashes in the instrument panel, accompanied by an audible signal and a message in the instrument panel screen.

Foot on brake flashes on the instrument panel, accompanied by an audible signal and a message in the instrument panel screen, if the brake pedal is not pressed on starting.

- ☞ Select a gear (position **M** or **A**) or reverse (position **R**).
- ☞ Release the parking brake unless it is programmed to automatic mode.
- ☞ Take your foot off the brake pedal, then accelerate.



A and **1** or **R** appear in the instrument panel screen.



When the engine is idling with the brakes off, if position **R**, **A** or **M** is selected, the vehicle will move off on its own without any action on the accelerator.

Automatic mode

- ☞ After starting the vehicle, select position **A** for enter automatic mode.



A appears in the instrument panel screen.

The gearbox is then operating in auto-active mode, without any action on the part of the driver. It continuously selects the most suitable gear, depending on the:

- style of driving,
- profile of the road.



For optimum acceleration, for example when overtaking another vehicle, press the accelerator pedal firmly past the point of resistance.

Manual gear changing

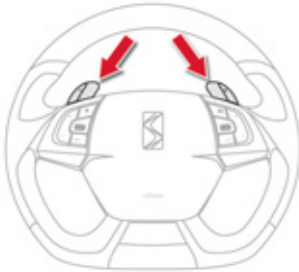

This selective gear change mode enables you to overtake, for example, while still remaining in automatic mode.

- ☞ Operate the + or - steering mounted control paddle.

The gearbox engages the gear requested if the engine speed permits. **A** is still displayed in the instrument panel.

After a few moments without any action on the controls, the gearbox resumes automatic control of the gears.

Manual mode

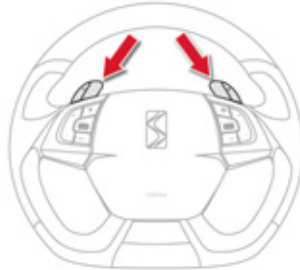

- ☞ When the vehicle has moved off, select position **M** to change to manual mode.
- ☞ Operate the + or - steering mounted control paddles.



A disappears and the gears engaged appear successively in the instrument panel screen.

The gear change commands are only carried out if the engine speed permits. The internal combustion engine is still running. It is not necessary to release the accelerator during gear changes.

When braking or slowing down, the gearbox changes down automatically to permit acceleration in the correct gear.

i At very low speed, if reverse gear is requested, this will only be taken into account when the vehicle is immobilised (foot on the brake). A warning lamp appears in the instrument panel screen.

! On sharp acceleration in manual mode, the gearbox will not change up unless the driver acts on the gear lever or the steering mounted paddles. Never select neutral **N** while the vehicle is moving. Only engage reverse gear **R** when the vehicle is immobilised with the brake pedal pressed.

Creep function (moving without the accelerator)

This function facilitates manoeuvring of the vehicle at low speed (when parking, in traffic jams, ...).

With the hybrid system active and the parking brake released, if position **A**, **M** or **R** is selected, the vehicle moves as soon as you take your foot off the brake pedal (even without any action on the accelerator).



For your safety, this function will only be activated if you press the brake pedal when engaging forward drive or reverse.

This function is deactivated if the driver's door is opened. To reactivate it, close the door and then press the brake or accelerator pedal.



Never leave children unsupervised in the vehicle with the hybrid system active.

Stopping the vehicle

Before switching off the engine, you can choose to:

- move to position **N** to engage neutral,
- leave the gear engaged; in this case, it will not be possible to move the vehicle.

In both cases, you should apply the parking brake to immobilise the vehicle.



When immobilising the vehicle, with the hybrid system active, you must place the gear selector in neutral **N**. Before carrying out any work in the engine compartment, check that the gear selector is in neutral **N** and that the parking brake is applied.

Operating fault

SERVICE

With the ignition on, the flashing of this warning lamp, accompanied by an audible signal and a message

in the instrument panel screen, indicates a malfunction of the gearbox.

Have it checked by a CITROËN dealer or a qualified workshop.



You must press the brake pedal when starting the engine. Whatever the circumstances, you must manually apply the parking brake when parking, unless the parking brake is programmed in automatic mode.

Lane departure warning system

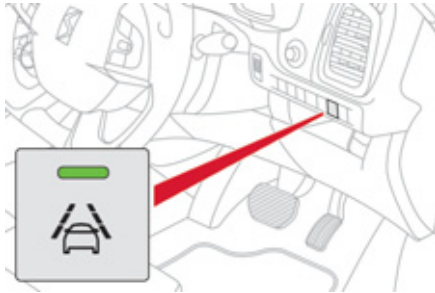

System which, using a camera which recognises solid or broken lines, detects the involuntary crossing of longitudinal traffic lane markings on the ground.

To provide safe driving, the camera analyses the image then, if the driver's attention drops, triggers a warning if the vehicle drifts over a lane marking (speed higher than 50 mph (80 km/h)).

This system is particularly useful on motorways and main roads.



The lane departure warning system cannot, in any circumstances, replace the need for vigilance and responsibility on the part of the driver.

Activation



☞ Press this button, the indicator lamp comes on.

Detection - alert

You are warned by the vibration of the driver's seat cushion:

- on the right-hand side, if the marking on the ground has been crossed on the right,
- on the left-hand side, if the marking on the ground has been crossed on the left.

No warning is transmitted while the direction indicator is active and for approximately 20 seconds after the direction indicator is switched off.

Deactivation



☞ Press this button again, the indicator lamp goes off.

The status of the system remains in the memory when the ignition is switched off.

Operating fault

In the event of a fault, the indicator lamp in the button flashes.

Contact a CITROËN dealer or a qualified workshop.



The detection may be impeded:

- if the markings on the ground are worn,
- if there is little contrast between the markings on the ground and the road surface,
- if the windscreen is dirty,
- in certain severe weather conditions: fog, heavy rain, snow, bright sunlight or direct exposure to the sun (low sun, leaving a tunnel, ...) and shade.

Head-up display

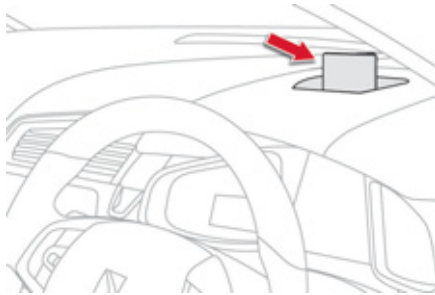

System which projects information onto a transparent strip in the field of vision of the driver so that they do not have to take their eyes off the road.

This system operates when the hybrid system is active and the settings are stored when the ignition is switched off.

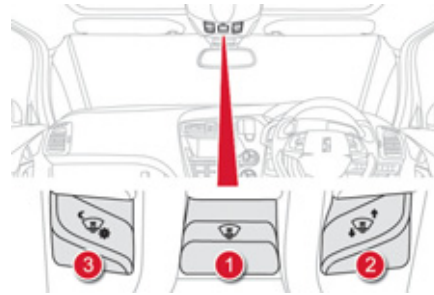
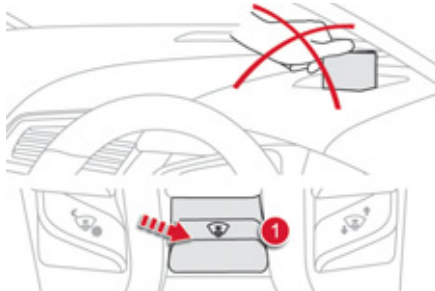

1. Head-up display on / off.
2. Display height adjustment.
3. Brightness adjustment.

Displays during operation

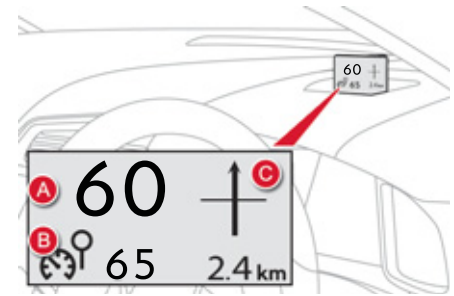

Once the system has been activated, the information projected in the head-up display is:

- A. The speed of your vehicle.
- B. Cruise control/speed limiter information.
- C. Navigation information (depending on version) which appears in blue while in electric mode.

i For more information on the navigation system, refer to the "Audio and telematics" section.

Activation / Deactivation

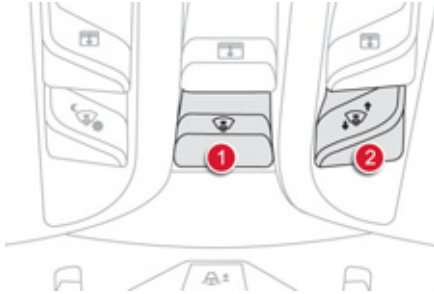

- ☞ With the hybrid system activated, press button 1. The activated/deactivated status when the engine is switched off is retained when the engine is switched on again. The strip retracts automatically 3 seconds after switching off the engine except in STOP mode of Stop & Start.

Height adjustment

- ☞ With the hybrid system active, adjust the display to the required height using button 2:
 - towards the rear to move the display up,
 - towards the front to move the display down.

Brightness adjustment

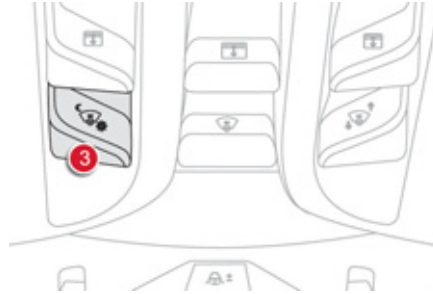

- ☞ With the hybrid system active, adjust the brightness of the information using button 3:
 - towards the rear to increase the brightness,
 - towards the front to decrease the brightness.

! We recommend that adjustments are only made using these buttons when the vehicle is stationary. When stationary or while driving, no objects should be placed around the transparent strip (or on its cover) to avoid blocking the strip output and preventing its correct operation.

i In certain extreme weather conditions (rain and/or snow, bright sunshine, ...) the head-up display may not be legible or may suffer temporary interference. Some sunglasses may hamper reading of the information. To clean the transparent strip, use a clean, soft cloth (such as a spectacles cloth or microfibre cloth). Do not use a dry or abrasive cloth or detergent or solvent products as these could scratch the strip or damage the anti-reflection coating.

Memorising speeds

This memorising of speeds applies to both the speed limiter and the cruise control.

You can memorise up to 5 speeds in the system.

By default, some speeds are already memorised.

With the Audio System



- ☞ Go to the main menu by pressing the **"MENU"** button.

- ☞ Select the "Personalisation-configuration" menu and confirm.
- ☞ Select "Vehicle parameters" menu and confirm.
- ☞ Select the "Driving assistance" line and confirm.
- ☞ Select the "Speeds memorised" line and confirm.
- ☞ Modify the speed.
- ☞ Select **"OK"** and confirm to save the modifications.

With eMyWay



- ☞ Go to the main menu by pressing **"SET UP"**.

- ☞ Select the "Configuration" menu and confirm.
- ☞ Select the "Vehicle parameters" menu and confirm.
- ☞ Select the "Driving assistance" line and confirm.
- ☞ Select the "Speeds memorised" line and confirm.
- ☞ Modify the speed.
- ☞ Select **"OK"** and confirm to save the modifications.

Access



- ☞ press the steering mounted **"MEM"** button to display the list of memorised speeds.

Selection

To select a memorised speed:

- ☞ Press and hold the "+" or "-" button; the system stops at the nearest memorised speed.
- ☞ Press and hold the "+" or "-" button again to select another memorised speed.

A reminder of the speed and the state of the system (active / inactive) is displayed in the instrument panel.



For safety reasons, the driver must only carry out these operations using the audio system screen when stationary.

Speed limiter

System which prevents the vehicle from exceeding the speed programmed by the driver. When the programmed speed limit is reached, pressing the accelerator pedal no longer has any effect.

Operation

The speed limiter is **switched on** manually: it requires a programmed speed of at least 20 mph (30 km/h).

The speed limiter is **switched off** by manual operation of the control.

The programmed speed can be exceeded temporarily by pressing the accelerator firmly beyond the point of resistance.

To return to the programmed speed, simply release the accelerator pedal.

The programmed speed remains in the memory when the ignition is switched off.

 The speed limiter cannot, in any circumstances, replace the need to respect speed limits, nor can it replace the need for vigilance and responsibility on the part of the driver.

Steering mounted controls

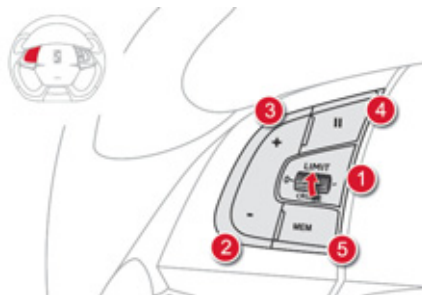

The functions of this system are grouped together on the steering mounted controls.

1. Speed limiter mode selection wheel.
2. Programmed value decrease button.
3. Programmed value increase button.
4. Speed limiter on / off button.
5. List of memorised speeds display button. (see "Memorising speeds")

Displays in the instrument panel

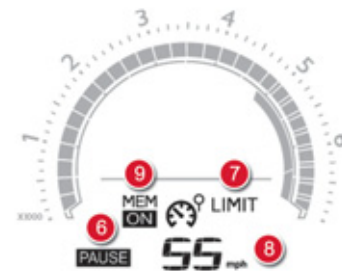

The programmed information is grouped together in the instrument panel screen.

6. Speed limiter on / off indication.
7. Speed limiter mode selection indication.
8. Programmed speed value.
9. Selection of a memorised speed. (see "Memorising speeds")



-  This information also appears in the head-up display. For more information, refer to the "Head-up display" section.



Programming

☞ Turn dial **1** to the "LIMIT" position: the speed limiter mode is selected but is not switched on (Pause).

You do not have to switch the speed limiter on in order to set the speed.

☞ Set the speed value by pressing button **2** or **3** (e.g.: 55 mph (90 km/h)).

You can then change the programmed speed using buttons **2** and **3**:

- by + or - 1 mph (km/h) = short press,
- in steps of + or - 5 mph (km/h) = maintained press.

If speed memorisation is available and activated on your vehicle, the programmed speed will stop at the closest memorised speed; refer to the corresponding paragraph.

- ☞ Switch the speed limiter on by pressing button **4**.
- ☞ Switch the speed limiter off by pressing button **4**: the display confirms that it has been switched off (Pause).

☞ Switch the speed limiter back on by pressing button **4** again.

Exceeding the programmed speed

Pressing the accelerator pedal to exceed the programmed speed will not have any effect unless you press the pedal **firmly** past the **point of resistance**.

The speed limiter is deactivated temporarily and the programmed speed, which is still displayed, flashes.

Returning to the programmed speed, by means of intentional or unintentional deceleration of the vehicle, automatically cancels the flashing of the programmed speed.



Exiting the speed limiter mode

☞ Turn dial **1** to the "0" position: the speed limiter mode is deselected. It disappears from the screen.

Operating fault

In the event of a fault with the speed limiter, the speed is cleared resulting in flashing of the dashes.

Have it checked by a CITROËN dealer or a qualified workshop.



⚠ On a steep descent or in the event of sharp acceleration, the speed limiter will not be able to prevent the vehicle from exceeding the programmed speed.

To avoid any risk of jamming of the pedals:

- ensure that the mat is positioned correctly,
- do not fit one mat on top of another.

Cruise control

System which automatically maintains the speed of the vehicle at the value programmed by the driver, without any action on the accelerator pedal.

Operation

The cruise control is **switched on** manually: it requires a minimum vehicle speed of 25 mph (40 km/h) and the engagement of second gear with sequential gear changing (position **M**). The cruise control is **switched off** manually or by pressing the brake pedal or on triggering of the "electronic stability programme" system for safety reasons.

It is possible to exceed the programmed speed temporarily by pressing the accelerator pedal. To return to the programmed speed, simply release the accelerator pedal. Switching off the ignition cancels any programmed speed value.

Steering mounted controls

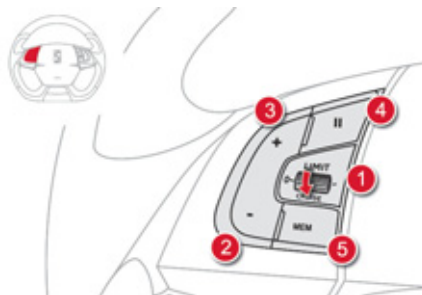

The functions of this system are grouped together on the steering mounted controls.

1. Cruise control mode selection dial.
2. Speed programming / value decrease button.
3. Speed programming / value increase button.
4. Cruise control off / resume button.
5. Stored speeds display button. (see "Storing speeds")



The cruise control system cannot, in any circumstances, replace the need to respect speed limits, nor can it replace the need for vigilance and responsibility on the part of the driver. You are advised to keep your feet near the pedals at all times.

Displays in the instrument panel

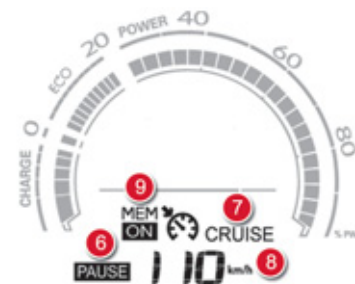

The programmed information is grouped together in the instrument panel screen.

6. Cruise control off / resume indication.
7. Cruise control mode selection indication.
8. Programmed speed value.
9. Selecting a stored speed. (see "Storing speeds")

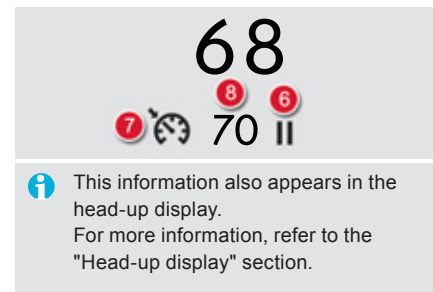

This information also appears in the head-up display. For more information, refer to the "Head-up display" section.



Programming

- ☞ Turn dial 1 to the **"CRUISE"** position: the cruise control mode is selected but is not switched on (Pause).
- ☞ Set the programmed speed by accelerating to the required speed, then press button 2 or 3 (e.g.: 70 mph (110 km/h)); the cruise control system is activated (ON).

You can then change the programmed speed using buttons 2 and 3:

- by + or - 1 mph (km/h) = short press,
- in steps of + or - 5 mph (km/h) = maintained press.

If storing speeds is available and activated on your vehicle, the programmed speed will stop at the closest stored speed; refer to the corresponding section.

- ☞ Stop the cruise control system by pressing button 4: this is confirmed in the screen (Pause).
- ☞ Switch on the cruise control again with another press on button 4.

Exceeding the programmed speed

Intentional or unintentional exceeding of the programmed speed results in flashing of this speed in the screen.

Return to the programmed speed, by means of intentional or unintentional deceleration of the vehicle, automatically cancels the flashing of the speed.

Exiting cruise control mode

- ☞ Turn dial 1 to the **"0"** position: the cruise control mode is deselected. It disappears from the screen.



Operating fault

In the event of a cruise control malfunction, the speed is cleared resulting in flashing of the dashes.

Have it checked by a CITROËN dealer or a qualified workshop.



- ⚠ When the cruise control is switched on, be careful if you maintain the pressure on one of the programmed speed changing buttons: this may result in a very rapid change in the speed of your vehicle.

Do not use the cruise control on slippery roads or in heavy traffic.

On a steep descent, the cruise control will not be able to prevent the vehicle from exceeding the programmed speed.

On steep climbs or when towing, the programmed speed may not be reached or maintained.

To avoid any risk of jamming of the pedals:

- ensure that the mat is positioned correctly,
- never fit one mat on top of another.

Parking sensors

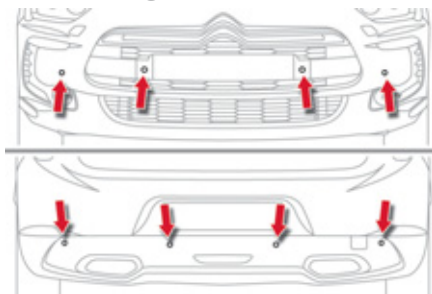

This system indicates the proximity of an obstacle (person, vehicle, tree, gate, etc.) which comes within the field of detection of sensors located in the bumper.

Certain types of obstacle (stake, roadworks cone, etc.) detected initially will no longer be detected at the end of the manoeuvre due to the presence of blind spots.



This function cannot, in any circumstances, take the place of the vigilance and responsibility of the driver.

Rear parking sensors

The system is switched on by engaging reverse gear. This is accompanied by an audible signal. The system is switched off when you exit reverse gear.

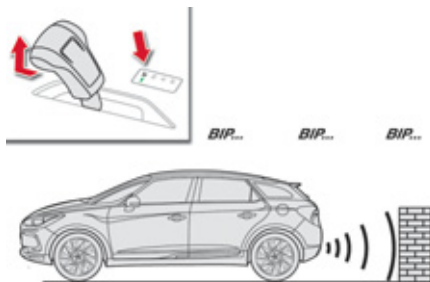

Audible assistance

The proximity information is given by an intermittent audible signal, the frequency of which increases as the vehicle approaches the obstacle. The sound emitted by the speaker (right or left) indicates the side on which the obstacle is located. When the distance between the vehicle and the obstacle becomes less than approximately thirty centimetres, the audible signal becomes continuous.



Visual assistance

This supplements the audible signal by displaying bars in the multifunction screen which move progressively nearer to the vehicle. When the obstacle is near, the "Danger" symbol is displayed in the screen.

Front parking sensors

In addition to the rear parking sensors, the front parking sensors are triggered when an obstacle is detected in front and the speed of the vehicle is still below 6 mph (10 km/h).

The front parking sensors are interrupted if the vehicle stops for more than three seconds in forward gear, if no further obstacles are detected or when the speed of the vehicle exceeds 6 mph (10 km/h).



The sound emitted by the speaker (front or rear) indicates whether the obstacle is in front or behind.

Deactivation / Activation of the front and rear parking sensors

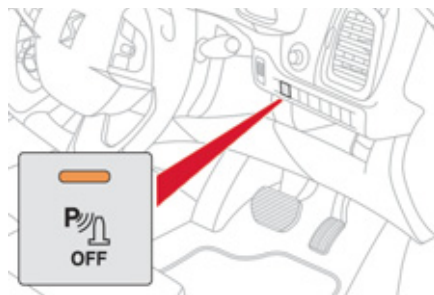

The function is deactivated by pressing this button. The indicator lamp in the button comes on.

Pressing this button again reactivates the function. The indicator lamp in the button goes off.



The function will be deactivated automatically if a trailer is being towed or a bicycle carrier is fitted (vehicle fitted with a towbar or bicycle carrier recommended by CITROËN).

Operating fault

SERVICE

In the event of a malfunction of the system, when reverse gear is engaged this warning lamp is displayed in the instrument panel and/or a message appears in the screen, accompanied by an audible signal (short beep). Contact a CITROËN dealer or a qualified workshop.



In bad weather or in winter, ensure that the sensors are not covered with mud, ice or snow. When reverse gear is engaged, an audible signal (long beep) indicates that the sensors may be dirty. Certain sound sources (motorcycle, lorry, pneumatic drill, etc.) may trigger the audible signals of the parking sensor system.

Reversing camera

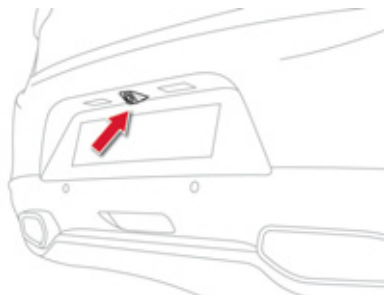

A reversing camera is activated automatically when reverse gear is engaged. The colour image is provided in the navigation screen.



The green lines represent the general direction of the vehicle.

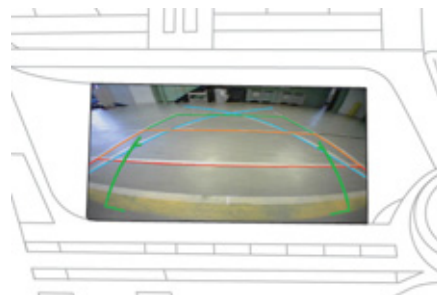

The red lines represent around 30 cm beyond the limit of your vehicle's rear bumper. The audible signal becomes continuous from this limit. The blue lines represent the maximum turning circle.

 Clean the reversing camera regularly using a sponge and a soft cloth.

005
Visibility

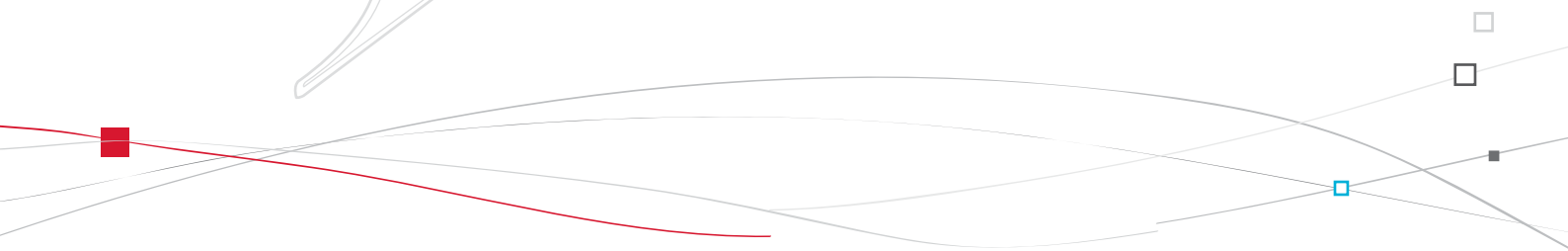



Lighting controls

System for selection and control of the various front and rear lamps providing the vehicle's lighting and signalling.

Main lighting

There are various lamps on the vehicle:

- sidelamps, to be seen,
- dipped beam headlamps to see without dazzling other drivers,
- main beam headlamps to see clearly when the road is clear,
- directional headlamps for improved visibility when cornering.

Additional lighting

Other lamps are installed to fulfil the requirements of particular driving conditions:

- rear foglamps to better signal the presence of the vehicle in foggy conditions,
- front foglamps for better visibility in foggy conditions and to improve lighting at intersections and when parking,
- daytime running lamps to be seen during the day.

Automatic lighting functions

Various automatic lighting functions are also available depending on options:





- guide-me-home lighting,
- directional headlamps,
- welcome lighting,
- daytime running lamps,
- automatic illumination of headlamps,
- automatic headlamp dipping.

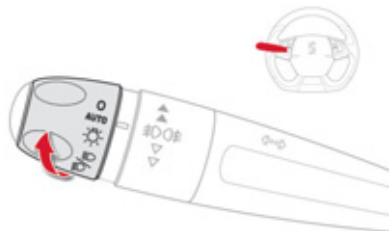

Selection ring for main lighting mode

Turn the ring to position the symbol required facing the mark.



-  Lighting off.
-  Automatic illumination of headlamps.
-  Sidelamps only.
-  Dipped or main beam headlamps.

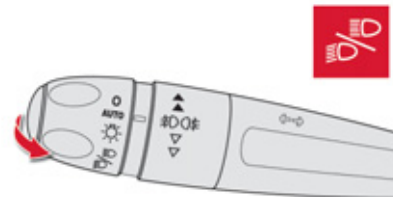

Dipping the headlamps

Pull the stalk to switch the lighting between dipped / main beam headlamps.

In the lighting off and sidelamps modes, the driver can switch on the main beam headlamps temporarily ("headlamp flash") by maintaining a pull on the stalk.

Displays

Illumination of the corresponding indicator lamp in the instrument panel confirms the lighting switched on.

Foglamps selection ring

The foglamps operate with dipped and main beam headlamps.

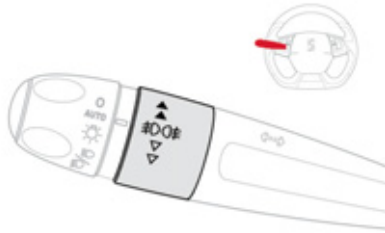

Front and rear foglamps

Rotate and release the ring:

- ☞ forwards a first time to switch on the front foglamps,
- ☞ forwards a second time to switch on the rear foglamps,
- ☞ rearwards a first time to switch off the rear foglamps,
- ☞ rearwards a second time to switch off the front fog lamps.

When the headlamps switch off with automatic illumination of headlamps (AUTO model) or when the dipped beam headlamps are switched off manually, the foglamps and sidelamps remain on.

- ☞ Turn the ring rearwards to switch off the foglamps, the sidelamps will then switch off.



In good or rainy weather, both day and night, the front foglamps and the rear foglamps are prohibited. In these situations, the power of their beams may dazzle other drivers. They should only be used in fog or snow.

In these weather conditions, it is your responsibility to switch on the foglamps and dipped headlamps manually as the sunshine sensor may detect sufficient light.

Do not forget to switch off the front foglamps and the rear foglamps when they are no longer needed.

i Lighting left on audible signal

An audible signal when a front door is opened warns the driver that the vehicle's exterior lighting is on, with the ignition off and in manual lighting mode. In this case, switching off the lighting stops the audible signal.

With the ignition off, if the dipped headlamps remain on, the vehicle goes into "ECO" mode to avoid discharging the battery.

The lighting goes off when you switch off the ignition, but you can always switch it on again using the lighting control stalk.

i In some weather conditions (e.g. low temperature or humidity), the presence of misting on the internal surface of the glass of the headlamps and rear lamps is normal; it disappears after the lamps have been on for a few minutes.

Daytime running lamps (LEDs)

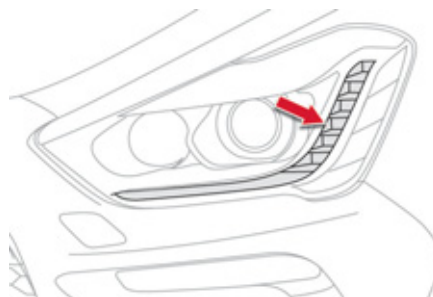

They come on when the engine is started.

Depending on the country of sale or where required by regulations, they are used for:

- daytime running lamps in day mode and sidelamps in night mode (they are brighter when daytime running lamps),
- or
- sidelamps in day and night mode.



The daytime running lamps can be activated and deactivated via the configuration menu.

Automatic illumination of headlamps

The sidelamps and dipped beam headlamps are switched on automatically, without any action on the part of the driver, when a low level of external light is detected or in certain cases of activation of the windscreen wipers.

As soon as the brightness returns to a sufficient level or after the windscreen wipers are switched off, the lamps are switched off automatically.

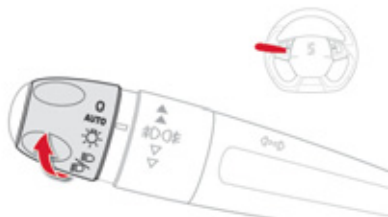

Activation

- ☞ Turn the ring to the **"AUTO"** position, automatic illumination of headlamps is activated and a message is displayed in the screen.

Deactivation

- ☞ Turn the ring to another position. Deactivation is accompanied by a message in the screen.

Association with the automatic "Guide-me-home" lighting

Association with the automatic lighting provides the "guide-me-home" lighting with the following additional options after the ignition is switched off:

- selection of the lighting duration of 15, 30 or 60 seconds in the vehicle parameters in the vehicle configuration menu,
- automatic activation of "guide-me-home" lighting when automatic illumination of headlamps is in operation.

Operating fault

SERVICE

In the event of a malfunction of the sunshine sensor, the lighting comes on, this warning lamp is displayed in the instrument panel and/or a message appears in the screen, accompanied by an audible signal. Contact a CITROËN dealer or a qualified workshop.



In fog or snow, the sunshine sensor may detect sufficient light. In this case, the lighting will not come on automatically. Do not cover the sunshine sensor, coupled with the rain sensor and located in the centre of the windscreen behind the rear view mirror; the associated functions would no longer be controlled.

Automatic headlamp dipping

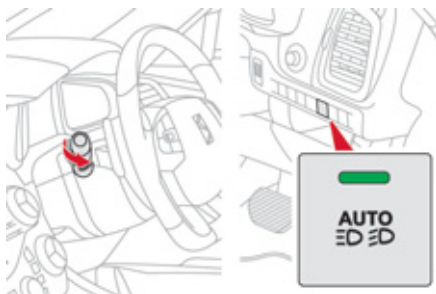

System which automatically changes between dipped and main beam according to the traffic conditions, using a camera in the rear view mirror.

! This automatic headlamp dipping system is a driving aid. The driver remains responsible for the vehicle's lighting, its correct use for the prevailing conditions of light, visibility and traffic and observation of driving and vehicle regulations.

Switching on



☞ Put the lighting control stalk ring in the "AUTO" position.



☞ Press the button, its indicator lamp comes on.

Activation



☞ Flash the headlamps (pull the stalk beyond the stiff point), which causes a change between dipped and main beam, the indicator lamp in the instrument panel comes on to confirm activation.



The system will be operational as soon as you have exceeded 15 mph (25 km/h). If the speed drops below 9 mph (15 km/h), the system changes to dipped beam.

Switching off



☞ Press the button, the indicator lamp goes off, the headlamps remain in their current position

Pause

If the situation requires a change of headlamp beam, driver can take over at any time:



☞ Flash the headlamps (pull the stalk beyond the stiff point) to temporarily deactivate the system (pause), this changes the headlamps to dipped beam.



☞ Flash the headlamps to reactivate the system.

i The system may suffer interference or not work correctly:

- under conditions of poor visibility (for example, snowfall, heavy rain or thick fog, ...),
- if the windscreen is dirty, misted or obscured (by a sticker, ...) in front of the camera,
- if the vehicle is facing highly reflective signs.

The system is not able to detect:

- road users that do not have their own lighting, such as pedestrians,
- road users whose lighting is obscured, such as vehicles running behind a safety barrier (on a motorway, for example),
- road users at the top or bottom of a steep slope, on twisty roads, on crossroads.

Manual guide-me-home lighting

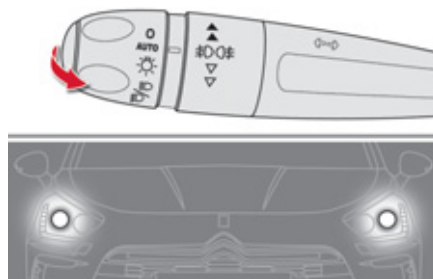

Temporarily keeping the dipped beam headlamps on after the vehicle's ignition has been switched off makes the exit of the vehicle's occupants easier when the light is poor.

Switching on

- ☞ Within one minute after switching of the ignition, "flash" the headlamps using the lighting stalk.
- ☞ A further "headlamp flash" switches the function off.

Switching off

The manual guide-me-home lighting switches off automatically after a set time (this time is programmable in the configuration menu).

Parking lamps

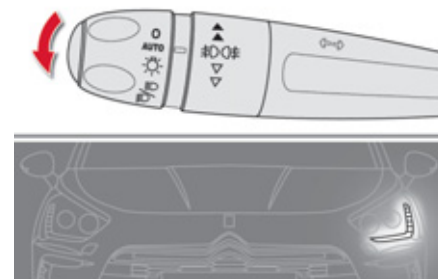

Side markers for the vehicle by illumination of the sidelamps on the traffic side only.

- ☞ Within one minute of switching off the ignition, operate the lighting control stalk up or down depending on the traffic side (for example: when parking on the left; lighting control stalk upwards; the right hand sidelamps are on).

This is confirmed by an audible signal and illumination of the corresponding direction indicator warning lamp in the instrument panel. To switch off the parking lamps, return the lighting control stalk to the middle position or switch on the ignition.

Exterior welcome lighting

The remote switching on of the lighting makes your approach to the vehicle easier in poor light. It is activated according to the level of light detected by the sunshine sensor.

Switching on



Press the open padlock on the remote control or the door handle with Keyless Entry and Starting.

The dipped beam headlamps and the sidelamps come on; your vehicle is also unlocked.

Switching off

The exterior welcome lighting switches off automatically after a set time, when the ignition is switched on or on locking the vehicle.

Programming



The lighting duration is selected via the vehicle configuration menu.



The duration of the welcome lighting is associated with and identical to that of the automatic guide-me-home lighting.

Door mirror spotlamps

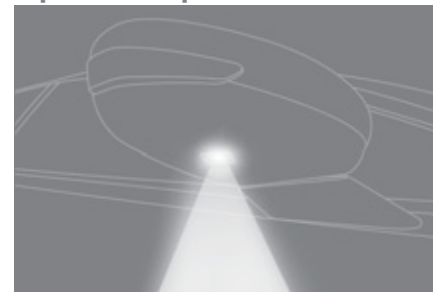

To make your approach to the vehicle easier, these illuminate:

- the zones facing the driver's and passenger's doors,
- the zones forward of the door mirrors and rearward of the front doors.

Switching on

The spotlamps come on:

- when you unlock the vehicle,
- when you switch off the ignition,
- when you open a door,
- when you use the remote control to locate the vehicle.

Switching off

They are timed to go off automatically.

Manual adjustment of halogen headlamps

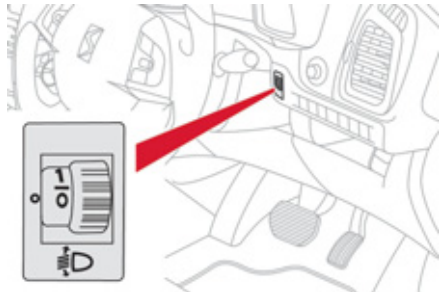

To avoid causing a nuisance to other road users, the height of the halogen headlamps should be adjusted according to the load in the vehicle.

0. 1 or 2 people in the front seats.
 - Intermediate setting.
1. 5 people + maximum authorised load.
 - Intermediate setting.
2. Driver + maximum authorised load.
 - Intermediate setting.
3. 5 people + maximum load in the boot.

 The initial setting is position "0".

Automatic adjustment of xenon headlamps

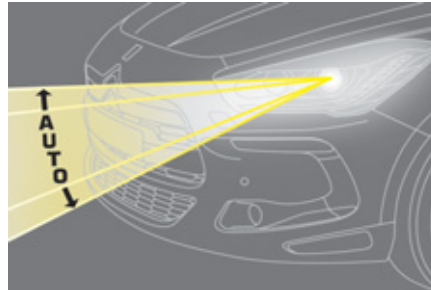

In order to avoid causing a nuisance to other road users, this system corrects the height of the xenon headlamps beam automatically and when stationary, in relation to the load in the vehicle.

SERVICE

If a fault occurs, this warning lamp is displayed in the instrument panel, accompanied by an audible signal and a message in the instrument panel screen. The system then places your headlamps in the lowest position.



If a fault occurs, do not touch the xenon bulbs. Contact a CITROËN dealer or a qualified workshop.

Directional lighting

When the dipped or main beam headlamps are on, this function, allows the light beams to better follow the road.

The use of this function, coupled with the xenon headlamps and the cornering lighting, considerably improves the quality of your lighting round bends.

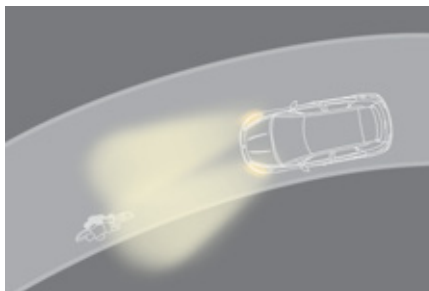

with directional lighting

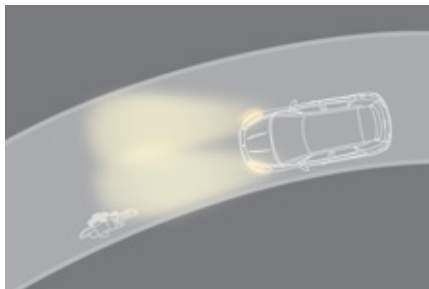

without directional lighting

Programming



The system is activated or deactivated in the vehicle configuration menu. The system is activated by default. The state of the system stays in memory on switching off the ignition.

Operating fault



If a fault occurs, this warning lamp flashes in the instrument panel, accompanied by a message in the screen. Contact a CITROËN dealer or a qualified workshop.



This function is inactive:

- when stationary or at low speeds,
- when reverse is engaged.

Cornering lighting

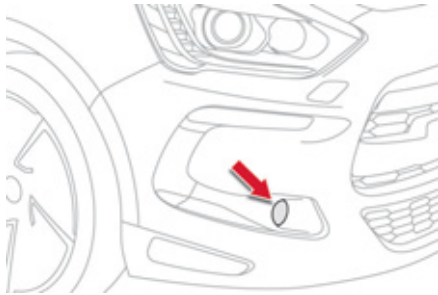

With dipped or main beams, this function makes use of the beam from a front foglamp to illuminate the inside of a bend, when the vehicle speed is below 25 mph (approximately 40 km/h) (urban driving, winding road, intersections, parking manoeuvres...).

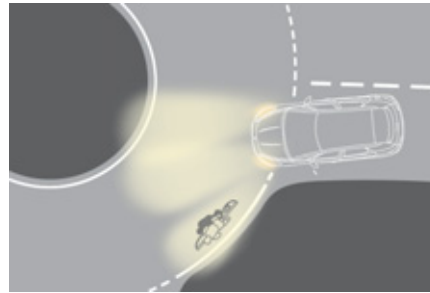

with cornering lighting

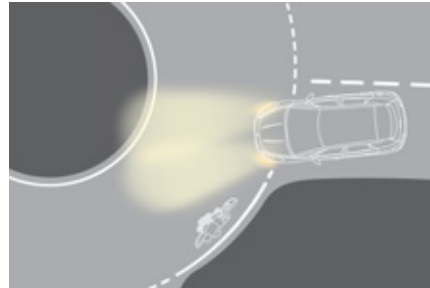

without cornering lighting

Switching on

This function starts:

- when the corresponding direction indicator is switched on,
- or
- from a certain angle of rotation of the steering wheel.

Switching off

The system does not operate:

- below a certain angle of rotation of the steering wheel,
- above 25 mph (40 km/h),
- when reverse gear is engaged.

Programming



The system is activated or deactivated in the vehicle configuration menu.

The system is activated by default.

Wiper controls

The vehicle's front and rear wipers are designed to improve the driver's visibility progressively according to the climatic conditions.

Programming

Various automatic wiper control modes are also available according to the following options:

- automatic rain sensitive windscreen wipers,
- rear wiping on engaging reverse gear.

Manual controls

The wipers are controlled directly by the driver.

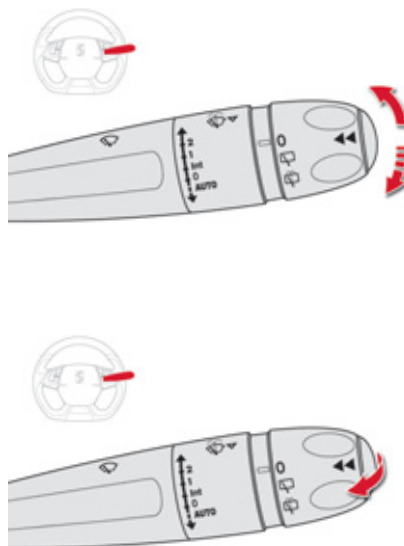

Windscreen wipers

Wiping speed:

2	fast (heavy rain),
1	normal (moderate rain),
Int	intermittent (proportional to the speed of the vehicle),
0	park,
AUTO ↓	automatic (press down and release),

single wipe (pull the stalk briefly towards you).

Rear wiper

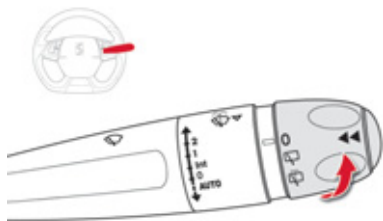

 If a significant accumulation of snow or ice is present, or when using a bicycle carrier on the boot, deactivate the automatic rear wiper via the configuration menu.

Rear wiper selection ring:



park,



intermittent wipe,



wash-wipe (set duration).

Reverse gear

When reverse gear is engaged, the rear wiper will come into operation if the windscreen wipers are operating.

Programming



The function is activated or deactivated via the configuration menu.

This function is activated by default.

Windscreen and headlamp wash

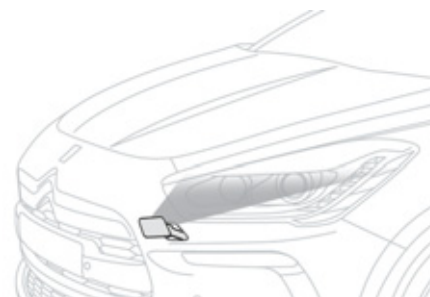

 Pull the windscreen wiper stalk towards you. The windscreen wash then the windscreen wipers operate for a fixed period.

The headlamp washers only operate when **the dipped beam headlamps are on**.

Automatic rain sensitive windscreen wipers

The windscreen wipers operate automatically, without any action on the part of the driver, if rain is detected (sensor behind the rear view mirror), adapting their speed to the intensity of the rainfall.

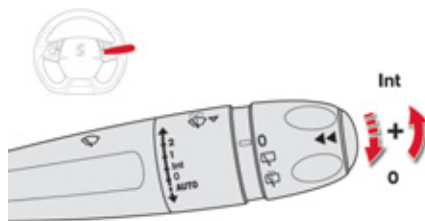
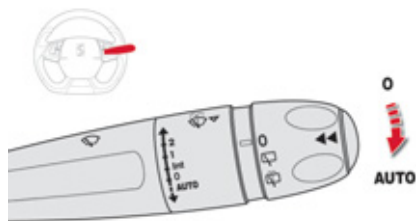

Switching on



Briefly push the control stalk downwards.

This warning lamp comes on in the instrument panel and a message is displayed.

Switching off



Briefly push the control stalk downwards again, or place the control stalk in another position (Int, 1 or 2).

This warning lamp goes off in the instrument panel and a message is displayed.



The automatic rain sensitive windscreen wipers must be reactivated by pushing the control stalk downwards, if the ignition has been off for more than one minute.

Operating fault

If a fault occurs with the automatic rain sensitive wipers, the wipers will operate in intermittent mode.

Have it checked by CITROËN dealer or a qualified workshop.



Do not cover the rain sensor, linked with the sunshine sensor and located in the centre of the windscreen behind the rear view mirror.

Switch off the automatic rain sensitive wipers when using an automatic car wash. In winter, it is advisable to wait until the windscreen is completely clear of ice before activating the automatic rain sensitive wipers.

Special position of the windscreen wipers



This position permits release of the windscreen wiper blades.

It is used for cleaning or replacement of the blades. It can also be useful, in winter, to detach the blades from the windscreen.

- ☞ Any action on the wiper stalk in the minute after switching off the ignition places the blades vertically on the screen.
- ☞ To park the blades again, switch on the ignition and operate the wiper stalk.



To maintain the effectiveness of the "flat-blade" type of wiper blades, it is advisable to:

- handle them with care,
- clean them regularly using soapy water,
- avoid using them to retain cardboard on the windscreen,
- replace them at the first signs of wear.



Courtesy lamps

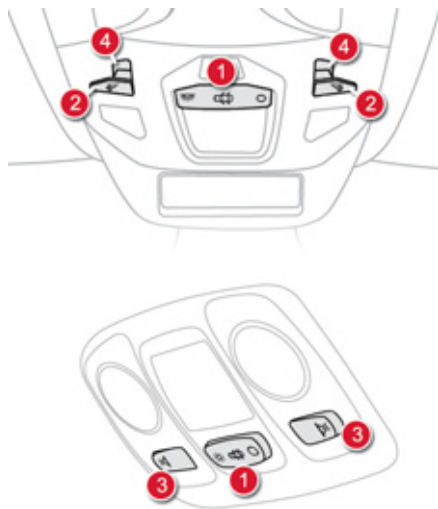

1. Front - rear courtesy lamp
2. Front map reading lamps
3. Rear map reading lamps
4. Interior mood LEDs

Front - rear courtesy lamps



In this position, the courtesy lamp comes on gradually:

- when the vehicle is unlocked,
- when the electronic key is removed from the reader,
- when opening a door,
- when the remote control locking button is activated, in order to locate your vehicle.

It switches off gradually:

- when the vehicle is locked,
- when the ignition is switched on,
- 30 seconds after the last door is closed.



Permanently off.



Permanent lighting.



With the "permanent lighting" mode, the lighting time varies according to the circumstances:

- with the ignition off, approximately ten minutes,
- in energy economy mode, approximately thirty seconds,
- with the hybrid system active, unlimited.

Front - rear map reading lamps

With the ignition on, press the corresponding switch.



Take care to avoid leaving anything in contact with the courtesy lamps.

Interior mood lighting

The dimmed passenger compartment lighting improves visibility in the vehicle when the light is poor.

Switching on



At night, the interior mood lighting comes on automatically when the sidelamps are switched on (for example, a source of light in the roof console illuminates the middle of the centre console).

The interior mood lighting switches off automatically when the sidelamps are switched off.

Adjusting the brightness of the courtesy lamp

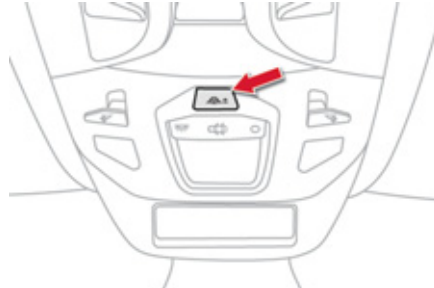

Lamps on: there are 7 levels of brightness.

The level of brightness increases progressively with each press of the button, returning to zero after the maximum level is reached.

A long press gives maximum brightness.

This adjustment is used to set the mood lighting level for the interior lamp, as well as for the door opening controls and the storage locations (depending on version).

Footwell lighting



The soft lighting provided by the footwell lamps improves visibility in the vehicle when the light is poor.

Activation

Its operation is identical to that of the courtesy lamps. The lighting comes on when one of the doors is opened.

169
Visibility



006
Child safety

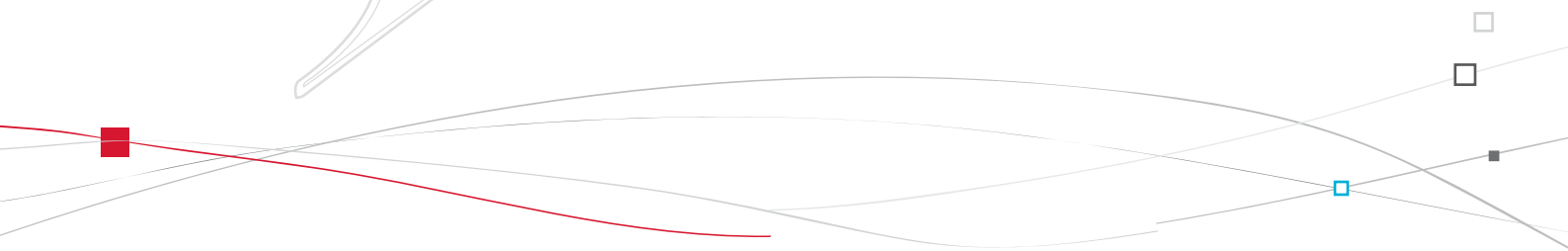



General points relating to child seats

Although one of CITROËN's main criteria when designing your vehicle, the safety of your children also depends on you.

For maximum safety, please observe the following recommendations:

- in accordance with European regulations, **all children under the age of 12 or less than one and a half metres tall must travel in approved child seats suited to their weight**, on seats fitted with a seat belt or ISOFIX mountings*,
- **statistically, the safest seats in your vehicle for carrying children are the rear seats,**
- **a child weighing less than 9 kg must travel in the "rearwards-facing" position both in the front and in the rear.**



CITROËN recommends that children should travel in the **outer rear seats** of your vehicle:

- **"rearwards-facing"** up to the age of 2,
- **"forwards-facing"** over the age of 2.

* The rules for carrying children are specific to each country. Refer to the legislation in force in your country.

Child seat in the front



"Rearwards-facing"

When a "rearwards-facing" child seat is installed on the **front passenger seat**, it is essential that the passenger airbag is deactivated. Otherwise, **the child would risk being seriously injured or killed if the airbag were to inflate.**



"Forwards-facing"

When a "forwards-facing" child seat is installed on the **front passenger seat**, adjust the vehicle's seat to the fully back and highest position with the seat back upright and leave the passenger's airbag activated.

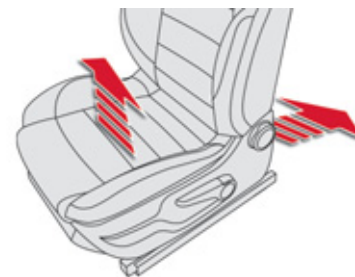

Passenger seat in the fully back and highest position.



Ensure that the seat belt is correctly tensioned.



Passenger airbag OFF

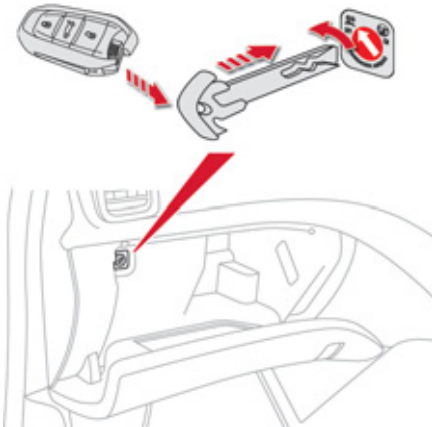

i For more information on deactivating the airbag, refer to the "Safety" section then "Airbags".



Refer to the advice given on the label present on both sides of the passenger's sun visor.

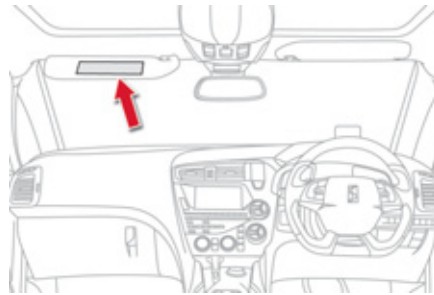





! To assure the safety of your child, you must deactivate the passenger's front airbag when you install a child seat in the rearwards facing position on the front passenger's seat. Otherwise, there is a risk that the child could be seriously injured or killed if the airbag were deployed.





Child seats recommended by CITROËN

CITROËN offers a complete range of recommended child seats which are secured using a **three point seat belt**:

Group 0+: from birth to 13 kg	Groups 1, 2 and 3: from 9 to 36 kg
 <p style="text-align: center;">L1 "RÖMER Baby-Safe Plus" Installed in the rearwards-facing position.</p>	 <p style="text-align: center;">L2 "KIDDY Comfort Pro" The impact shield must be used for carrying young children (from 9 to 18 kg).</p>
Groups 2 and 3: from 15 to 36 kg	
	<p style="text-align: center;">L4 "KLIPPAN Optima" From the age of 6 years (approximately 22 kg), the booster is used on its own.</p>
	<p style="text-align: center;">L5 "RÖMER KIDFIX" Can be fitted to the vehicle's ISOFIX mountings. The child is restrained by the seat belt.</p>

Installing child seats attached using the seat belt

In accordance with European regulations, this table indicates the options for installing child seats secured using a seat belt and universally approved (**a**) in accordance with the weight of the child and the seat in the vehicle:

Weight of the child and indicative age					
Seat		Under 13 kg (groups 0 (b) and 0+) Up to approx 1 year	From 9 to 18 kg (group 1) 1 to 3 years approx	From 15 to 25 kg (group 2) 3 to 6 years approx	From 22 to 36 kg (group 3) 6 to 10 years approx
Front passenger seat (c) with height adjustment		U (R)	U (R)	U (R)	U (R)
Outer rear seats		U	U	U	U
Centre rear seat		X	X	X	X

a: universal child seat, child seat that can be installed in all vehicles using a seat belt.

b: group 0, from birth to 10 kg. Shells seats and baby carriers cannot be installed in the front passenger seat.

c: consult the legislation in force in your country before installing your child on this seat.

U: seat suitable for the installation of a child seat secured using a seat belt and universally approved, "rearwards-facing" and/or "forwards-facing".

U (R): same as **U**, with the passenger seat adjusted to the highest position and as far back as possible.

X: seat position not suitable for installation of a child seat for the weight class indicated.

Advice on child seats

 The incorrect installation of a child seat in a vehicle compromises the child's protection in the event of an accident.

Ensure that there is no seat belt or seat belt buckle under the child seat, as this could destabilise it.

Remember to fasten the seat belts or the child seat harnesses keeping the slack relative to the child's body to a minimum, even for short journeys.

When installing a child seat using the seat belt, ensure that the seat belt is tightened correctly on the child seat and that it secures the child seat firmly on the seat of your vehicle. If your passenger seat is adjustable, move it forwards if necessary.

At rear seating positions, always leave sufficient space between the front seat and:

- a "rearwards facing" child seat,
- the child's feet for a child seat fitted "forwards facing".

To do this, move the front seat forwards and, if necessary, move its backrest into the upright position.

For optimum installation of the "forwards-facing" child seat, ensure that the back of the child seat is in contact with the back of the vehicle's seat and remove the head restraint. Ensure that the head restraint is stored or attached securely to prevent it from being thrown around the vehicle in the event of sharp braking. Refit it if an adult uses the seating position.

Children under the age of 10 must not travel in the "forwards-facing" position on the front passenger seat, unless the rear seats are already occupied by other children, cannot be used or are absent.

Deactivate the passenger airbag when a "rearwards-facing" child seat is installed on the front seat.

Otherwise, the child would risk being seriously injured or killed if the airbag were to inflate.

Installing a booster seat

The chest part of the seat belt must be positioned on the child's shoulder without touching the neck.

Ensure that the lap part of the seat belt passes correctly over the child's thighs. CITROËN recommends the use of a booster seat which has a back, fitted with a seat belt guide at shoulder level.

As a safety precaution, do not leave:

- a child or children alone and unsupervised in a vehicle,
- a child or an animal in a vehicle which is exposed to the sun, with the windows closed,
- the keys within reach of children inside the vehicle.

To prevent accidental opening of the doors and rear windows, use the "Child lock". Take care not to open the rear windows by more than one third.

To protect young children from the rays of the sun, fit side blinds on the rear windows.

"ISOFIX" mountings

Your vehicle has been approved in accordance with the **latest ISOFIX regulations**.

The seats, represented below, are fitted with regulation ISOFIX mountings.

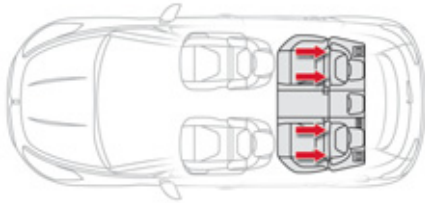

There are three rings for each seat.

- Two rings **A**, located between the vehicle seat back and cushion, indicated by a label.

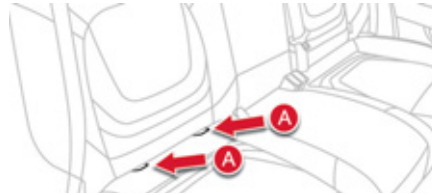

- A ring **B**, behind the seat, referred to as the **TOP TETHER** for fixing the upper strap.



This ISOFIX mounting system provides fast, reliable and safe fitting of the child seat in your vehicle.

The **ISOFIX child seats** are fitted with two latches which are easily secured on the two rings **A**.

Some also have an **upper strap** which is attached to ring **B**.

To attach this strap, raise the vehicle seat's head restraint then pass the hook between its rods. Then fix the hook on ring **B** and tighten the upper strap.

 The incorrect installation of a child seat in a vehicle compromises the child's protection in the event of an accident.

For information regarding the ISOFIX child seats which can be installed in your vehicle, refer to the table showing the locations for installing ISOFIX child seats.



ISOFIX child seat

Recommended by CITROËN and approved for your vehicle

RÖMER Duo Plus ISOFIX
(size category **B1**)

Group 1: from 9 to 18 kg



Installed only in the forwards-facing position.

Fitted with an upper strap to be secured on the upper ring **B**, referred to as the TOP TETHER.

Three seat body angles: sitting, reclining, lying.

Adjust the front seat of the vehicle so that the child's feet do not touch the back of the seat.

Can be installed forwards-facing by attaching it to the seat using a three-point seat belt.





This child seat can also be used on seats which are not fitted with ISOFIX mountings. In this case, it must be attached to the vehicle seat using the three point seat belt.

Follow the instructions for fitting the child seat given in the seat manufacturer's installation guide.

Locations for installing ISOFIX child seats

In accordance with European Regulations, this table indicates the options for installing ISOFIX child seats on seats in the vehicle fitted with ISOFIX mountings.

In the case of universal and semi-universal ISOFIX child seats, the ISOFIX size category, determined by a letter from **A** to **G**, is indicated on the child seat next to the ISOFIX logo.

		Weight of the child / indicative age									
		Less than 10 kg (group 0) Up to approx. 6 months		Less than 10 kg (group 0) Less than 13 kg (group 0+) Up to approx. 1 year			From 9 to 18 kg (group 1) From approx. 1 to 3 years				
Type of ISOFIX child seat		Sleeper cot*		"rearwards-facing"			"rearwards-facing"		"forwards-facing"		
ISOFIX size category		F	G	C	D	E	C	D	A	B	B1
Front passenger seat		X									
Outer rear seats		IL-SU**		IL-SU			IL-SU		IUF IL-SU		
Centre rear seat		X									

IUF: seat suitable for the installation of an Isofix **Universal** seat, "Forwards-facing" secured using the top belt.

IL-SU: seat suitable for the installation of an Isofix **Semi-Universal** seat either:

- "rearwards-facing" fitted with a top belt or a stay,
- "forwards-facing" fitted with a stay,
- a sleeper cot fitted with an upper strap or a stay.

For advice on securing of the top belt, refer to the paragraph "Isofix mountings".

X: seat not suitable for the installation of a child seat or shell for the weight group indicated.

* Sleeper cots cannot be fitted to the front passenger's seat.

** The ISOFIX sleeper cot, fixed to the lower ISOFIX rings, occupies all of the rear seats.



Electric child lock

Remote control system to prevent opening of the rear doors using their interior controls and use of the rear electric windows.

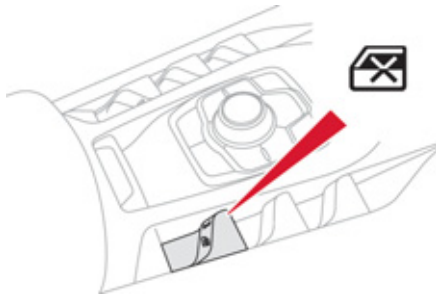

Switching on



☞ With the ignition on, press this button.

The indicator lamp in the button comes on, accompanied by a message to confirm that the child lock is on.

This indicator lamp remains on until the child lock is switched off.

It is still possible to open the doors from the outside and operate the rear electric windows from the driver's control panel.

Switching off



☞ With the ignition on, press this button again.

The indicator lamp in the button goes off, accompanied by a message to confirm that the child lock is off.

This indicator lamp remains off while the child lock is switched off.



Any other status of the indicator lamp indicates a fault with the electric child lock.

Have it checked by a CITROËN dealer or a qualified workshop.



This system is independent and in no circumstances does it take the place of the central locking control.

Check the status of the child lock each time you switch on the ignition.

Always remove the key from the ignition when leaving the vehicle, even for a short time.

In the event of a serious impact, the electric child lock is switched off automatically to permit the exit of the rear passengers.

007
Safety

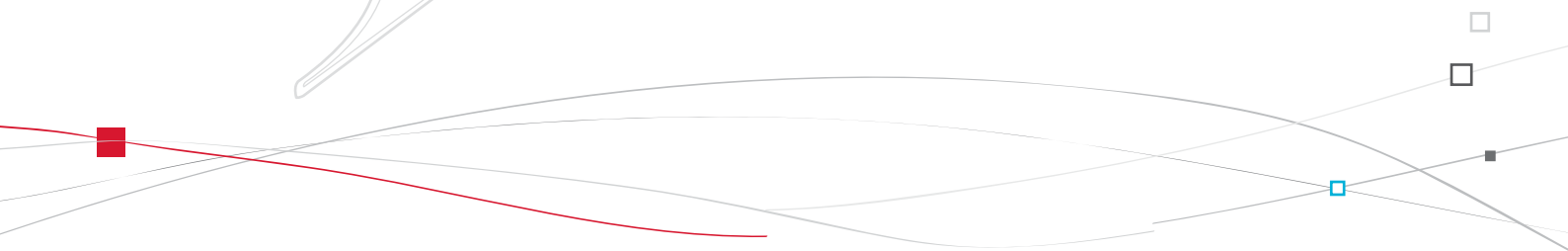



Direction indicators

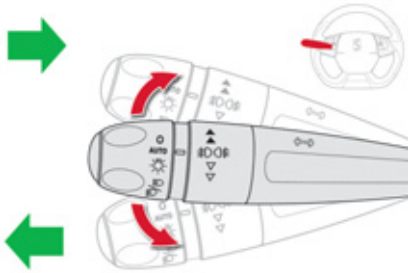

- ☞ Lower the lighting control stalk fully when moving to the left.
- ☞ Raise the lighting control stalk fully when moving to the right.

i If you forget to cancel the direction indicators for more than twenty seconds, the volume of the audible signal will increase if the speed is above 40 mph (60 km/h).

"Motorway" function

Move the stalk briefly upwards or downwards, without going beyond the point of resistance; the corresponding direction indicators will flash 3 times.

Hazard warning lamps

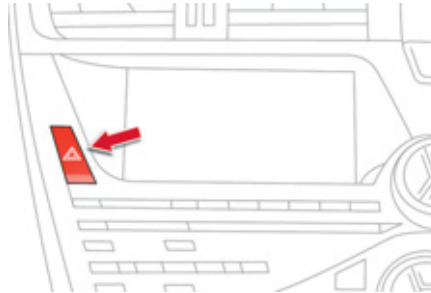

Press the button, the direction indicators flash. They can operate with the ignition off.

Automatic operation of hazard warning lamps

When braking in an emergency, depending on the rate of deceleration, as well as when the ABS regulation is invoked or in the event of an impact, the hazard warning lamps come on automatically.

They switch off automatically the first time you accelerate.

- ☞ You can also switch them off by pressing the button.

Emergency or assistance call

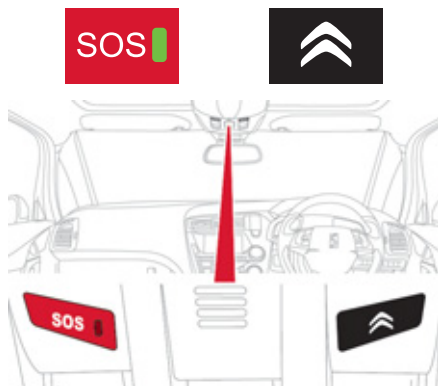

This system allows you to make an emergency or assistance call to the emergency services or to the dedicated CITROËN service.

i For more information on the use of this function, refer to the "Audio and telematics" section.

Horn

Audible warning system to alert other road users to an imminent danger.

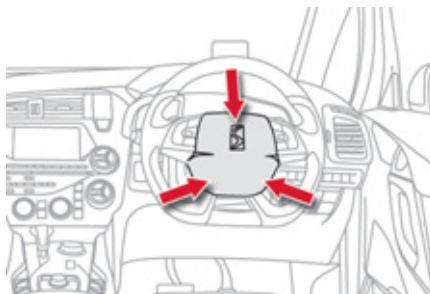

☞ Press the central part of the multifunction steering wheel.

i Use the horn moderately and only in the following circumstances:

- immediate danger,
- overtaking a cyclist or pedestrian,
- approaching a location lacking visibility.

Tyre under-inflation detection

System which automatically checks the pressure of the tyres while driving.



Sensors fitted in each valve trigger a warning in the event of malfunction (speed above 12 mph (20 km/h)).

The spare wheel is not fitted with a sensor.

i The tyre under-inflation detection system is an aid to driving which does not replace the need for the driver to be vigilant or to drive responsibly.

Under-inflated tyre

A message appears in the instrument panel screen, accompanied by an audible signal, to identify the wheel concerned.

☞ Check the tyre pressures as soon as possible. This check must be carried out when the tyres are cold.

Puncture

STOP



This warning lamp and the **STOP** warning lamp come on, accompanied by an audible signal and a message in the instrument panel screen identifying the wheel concerned.

- ☞ Stop immediately, avoiding any sudden movement of the steering wheel and the brakes.
- ☞ Change the damaged wheel (punctured or very deflated tyre), and have the tyre pressure checked as soon as possible.

Sensor(s) not detected or faulty

A message appears in the instrument panel screen, accompanied by an audible signal, to identify the wheel or wheels which are not detected or to indicate a fault in the system. Contact a CITROËN dealer or a qualified workshop to replace the faulty sensor(s).

i This message is also displayed when one of the wheels is away from the vehicle (being repaired) or when one or more wheels without a sensor are fitted.

! All repairs and changing of tyres on a wheel fitted with this system must be carried out by a CITROËN dealer or a qualified workshop.

If, when changing a tyre, you install a wheel which is not detected by your vehicle (example: fitting of snow tyres), you must have the system reinitialised by a CITROËN dealer or a qualified workshop.

i This system does not avoid the need to have the tyre pressures checked regularly (refer to "Identification markings") to ensure that the optimum dynamic performance of the vehicle is maintained and prevent premature wear of the tyres, particularly in arduous driving conditions (heavy load, high speed).

The tyre pressures must be checked cold, at least once a month. Remember to check the pressure of the spare wheel.

The tyre under-inflation detection system may experience temporary interference due to electromagnetic signals on a frequency close to that used by the system.



Electronic stability programme (ESC)

Electronic Stability Programme incorporating the following systems:

- the anti-lock braking system (ABS) and the electronic brake force distribution (EBFD),
- the emergency braking assistance,
- the anti-slip regulation (ASR) or traction control,
- the dynamic stability control (DSC).

Definitions

Anti-lock braking system (ABS) and electronic brake force distribution (EBFD)

This system improves the stability and manoeuvrability of your vehicle when braking and provides improved control in corners, in particular on poor or slippery road surfaces. The ABS prevents wheel lock in the event of emergency braking.

The electronic brake force distribution system manages the braking pressure wheel by wheel.

Emergency braking assistance

In an emergency, this system enables you to reach the optimum braking pressure more quickly and therefore reduce the stopping distance.

It is triggered in relation to the speed at which the brake pedal is pressed. This is felt by a reduction in the resistance of the pedal and an increase in the effectiveness of the braking.

Anti-slip regulation (ASR)

The ASR system (also known as Traction Control) optimises traction in order to avoid wheel slip by acting on the brakes of the driving wheels and on the engine. It also improves the directional stability of the vehicle on acceleration.

Dynamic stability control (DSC)

If there is a difference between the path followed by the vehicle and that required by the driver, the DSC monitors each wheel and automatically acts on the brake of one or more wheels and on the engine to return the vehicle to the required path, within the limits of the laws of physics.

Intelligent traction control system ("Snow motion")

Your vehicle has a system to help driving on snow: **intelligent traction control**.

This system detects situations of difficult surface adhesion that could make it difficult to move off or make progress on deep fresh snow or compacted snow.

In these situations, the **intelligent traction control** limits the amount of wheel slip to provide the best traction and trajectory control for your vehicle.

In extremely severe conditions (deep snow, mud, ...), when it proves impossible to move off, it may be useful to temporarily deactivate the ESP/ASR systems to allow the wheels to spin freely and so allow movement of the vehicle.

 The use of snow tyres is strongly recommended on surfaces offering low levels of adhesion.

Operation

Anti-lock braking system (ABS) and electronic brake force distribution (EBFD)





When this warning lamp comes on, accompanied by an audible signal and a message, it indicates that there is a fault with the ABS, which could cause loss of control of the vehicle when braking.



When this warning lamp comes on, coupled with the **STOP** warning lamp, accompanied by an audible signal and a message, it indicates that there is a fault with the electronic brake force distribution (EBFD), which could cause loss of control of the vehicle when braking.

You must stop as soon as it is safe to do so. In both cases, contact a CITROËN dealer or a qualified workshop.

 When changing wheels (tyres and rims), make sure that these are approved for your vehicle.
Normal operation of the ABS may make itself felt by slight vibrations of the brake pedal.

 **In emergency braking, press very firmly without releasing the pressure.**

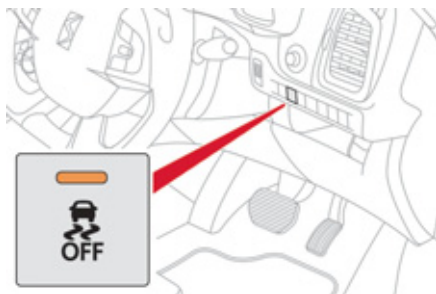

Dynamic stability control (DSC)

Activation

This system is activated automatically each time the vehicle is started.

It comes into operation in the event of a grip or trajectory problem.



This is indicated by flashing of this warning lamp in the instrument panel.

Deactivation

In exceptional conditions (starting a vehicle which is bogged down, stuck in snow, on soft ground...), it may be advisable to deactivate the DSC system, so that the wheels can move freely and regain grip.

But it is recommended that the system be reactivated as soon as possible.



☞ Press the button.



This warning lamp and the indicator lamp in the button come on: the DSC system no longer acts on the operation of the engine.

Reactivation

The system is reactivated automatically each time the ignition is switched back on or from 30 mph (50 km/h).



☞ Press the button again to reactivate it manually.

Operating fault



If this warning lamp comes on, accompanied by an audible signal and a message in the instrument panel screen, this indicates a fault with the system.

Contact a CITROËN dealer or a qualified workshop to have the system checked.



The DSC system offers exceptional safety in normal driving, but this should not encourage the driver to take extra risks or drive at high speed. The correct operation of the system depends on observation of the manufacturer's recommendations regarding the wheels (tyres and rims), the braking components, the electronic components and the CITROËN assembly and operation procedures. After an impact, have the system checked by a CITROËN dealer or a qualified workshop.

Seat belts

Front seat belts



The front seat belts are fitted with a pretensioning and force limiting system. This system improves safety in the front seats in the event of a front or side impact. Depending on the severity of the impact, the pretensioning system instantly tightens the seat belts against the body of the occupants. The pretensioning seat belts are active when the ignition is on. The force limiter reduces the pressure of the seat belt on the chest of the occupant, so improving their protection.

Rear seat belts

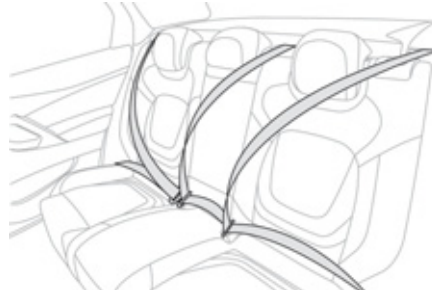

The rear seats are each fitted with a seat belt, three-point anchorages with inertia reel and force limiter (except for the centre rear seat).

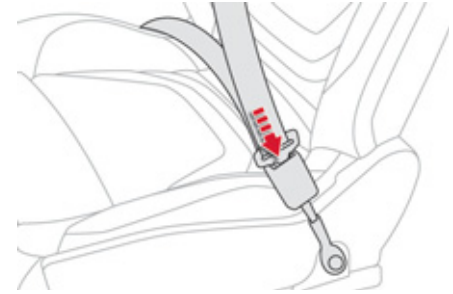

Fastening

- ☞ Pull the strap, then insert the tongue in the buckle.
- ☞ Check that the seat belt is fastened correctly by pulling the strap.

Unfastening

- ☞ Press the red button on the buckle.
- ☞ Guide the seat belt as it reels in.

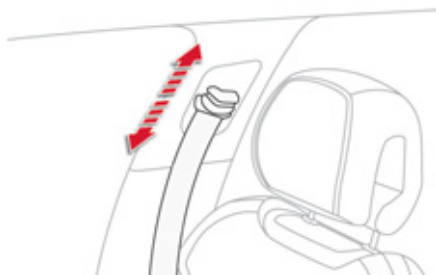

Front seat belt height adjustment

- ☞ To adjust the anchorage point, squeeze the control and slide it until you find a notch.

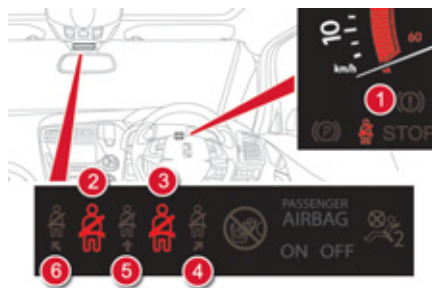

Seat belt not fastened / unfastened warning lamps*

1. Front and/or rear seat belts not fastened / unfastened warning lamp in the instrument panel.
2. Front left seat belt warning lamp.
3. Front right seat belt warning lamp.
4. Rear right seat belt warning lamp.
5. Rear centre seat belt warning lamp.
6. Rear left seat belt warning lamp.



From approximately 12 mph (20 km/h), the warning lamp(s) flash for two minutes accompanied by an audible signal. Once these two minutes have elapsed, the warning lamp(s) remain on until the driver or one or more passengers fasten their seat belt.

Front seat belt warning lamps



On switching on the ignition, warning lamp 1 comes on in the instrument panel and the corresponding warning lamp 2 and/or 3 come(s) on in red in the passenger's seat belt and front airbag warning lamp display if the corresponding seat belt is not fastened or is unfastened.

Rear seat belt warning lamps



On switching on the ignition, the corresponding warning lamps 4, 5 and 6 come on in red for about 30 seconds if a seat belt is not fastened. Above 12 mph (20 km/h), the corresponding warning lamps 4, 5 or 6 comes on in red, accompanied by an audible signal and a message in the instrument panel screen, when a rear passenger has unbuckled their seat belt.

* According to version and/or country of sale.



The driver must ensure that passengers use the seat belts correctly and that they are all restrained securely before setting off.

Wherever you are seated in the vehicle, always fasten your seat belt, even for short journeys.

Do not interchange the seat belt buckles as they will not fulfil their role fully.

The seat belts are fitted with an inertia reel permitting automatic adjustment of the length of the strap to your size. The seat belt is stowed automatically when not in use.

Before and after use, ensure that the seat belt is reeled in correctly. The lower part of the strap must be positioned as low as possible on the pelvis. The upper part must be positioned in the hollow of the shoulder.

The inertia reels are fitted with an automatic locking device which comes into operation in the event of a collision, emergency braking or if the vehicle rolls over. You can release the device by pulling firmly on the strap and releasing it so that it reels in slightly.

In order to be effective, a seat belt must:

- be tightened as close to the body as possible,
- be pulled in front of you with a smooth movement, checking that it does not twist,
- be used to restrain only one person,
- not bear any trace of cuts or fraying,
- not be converted or modified to avoid affecting its performance.

In accordance with current safety regulations, for all repairs on your vehicle, go to a qualified workshop with the skills and equipment needed, which a CITROËN dealer is able to provide.

Have your seat belts checked regularly by a CITROËN dealer or a qualified workshop, particularly if the straps show signs of damage.

Clean the seat belt straps with soapy water or a textile cleaning product, sold by CITROËN dealers.

After folding or moving a seat or rear bench seat, ensure that the seat belt is positioned and reeled in correctly.

Recommendations for children

Use a suitable child seat if the passenger is less than 12 years old or shorter than one and a half metres.

Never use the same seat belt to secure more than one person.

Never allow a child to travel on your lap.

In the event of an impact

Depending on the nature and seriousness of the impact, the pretensioning device may be deployed before and independently of the airbags. Deployment of the pretensioners is accompanied by a slight discharge of harmless smoke and a noise, due to the activation of the pyrotechnic cartridge incorporated in the system.

In all cases, the airbag warning lamp comes on.

Following an impact, have the seat belts system checked, and if necessary replaced, by a CITROËN dealer or a qualified workshop.

Airbags

System designed to maximise the safety of the occupants (with the exception of the rear centre passenger) in the event of violent collisions.

The airbags supplement the action of the force-limiting seat belts (with the exception of the centre rear passenger).

If a collision occurs, the electronic detectors record and analyse the front and side impacts sustained in the impact detection zones:

- in the case of a serious impact, the airbags are deployed instantly and contribute towards better protection of the occupants of the vehicle (with the exception of the rear centre passenger); immediately after the impact, the airbags deflate rapidly so that they do not hinder visibility or the exit of the occupants,
- in the case of a minor or rear impact or in certain roll-over conditions, the airbags will not be deployed; the seat belt alone contributes towards ensuring your protection in these situations.

The airbags do not operate when the ignition is switched off.

This equipment will only deploy once. If a second impact occurs (during the same or a subsequent accident), the airbag will not be deployed again.

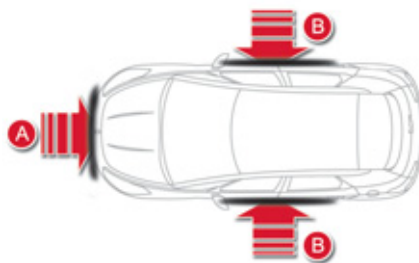

Impact detection zones

- Front impact zone.
- Side impact zone.



Deployment of the airbag(s) is accompanied by a slight emission of smoke and a noise, due to the activation of the pyrotechnic cartridge incorporated in the system. This smoke is not harmful, but sensitive individuals may experience slight irritation. The noise of the detonation may result in a slight loss of hearing for a short time.

Front airbags

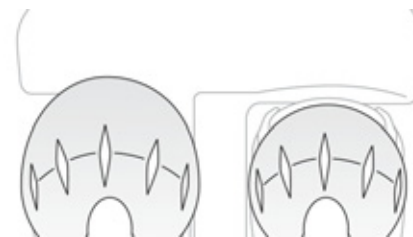

System which protects the driver and front passenger in the event of a serious front impact in order to limit the risk of injury to the head and thorax.

The driver's airbag is fitted in the centre of the steering wheel; the front passenger's airbag is fitted in the dashboard above the glove box.

Deployment

The airbags are deployed simultaneously, unless the passenger's front airbag is deactivated, in the event of a serious front impact to all or part of the front impact zone **A**, in the longitudinal centreline of the vehicle on a horizontal plane and directed from the front to the rear of the vehicle.

The front airbag inflates between the thorax and head of the front occupant of the vehicle and the steering wheel, driver's side, and the dashboard, passenger's side to cushion their forward movement.

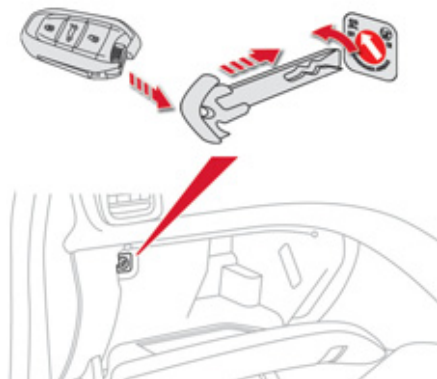

Deactivation

Only the passenger's front airbag can be deactivated:

- ☞ **with the ignition off**, insert the key in the passenger airbag deactivation switch,
- ☞ turn it to the **"OFF"** position,
- ☞ then, remove the key keeping the switch in the new position.



According to version, this warning lamp comes on either in the instrument panel or in the seat belt and passenger's front airbag warning lamp display when the ignition is on and until the airbag is reactivated.



To assure the safety of your child, the passenger's front airbag must be deactivated when you install a "rear facing" child seat on the front passenger seat.

Otherwise, the child would risk being seriously injured or killed if the airbag were deployed.

Reactivation

When you remove the child seat, **with the ignition off**, turn the switch to the **"ON"** position to reactivate the airbag and so assure the safety of your front passenger in the event of an impact.



With the ignition on, this warning lamp comes on in the seat belt and passenger's front airbag warning lamp display for approximately one minute, if the passenger's front airbag is activated.

Operating fault



If this warning lamp comes on in the instrument panel, accompanied by an audible warning and a message in the instrument panel screen, contact a CITROËN dealer or a qualified workshop to have the system checked. The airbags may no longer be deployed in the event of a serious impact.



If this warning lamp flashes, contact a CITROËN dealer or a qualified workshop. The passenger's front airbag may no longer be deployed in the event of a serious impact.



If even one of the two airbag warning lamps comes on continuously, do not install a child seat on the front passenger seat. Have it checked by a CITROËN dealer or qualified workshop.

Lateral airbags



System which protects the driver and front passenger in the event of a serious side impact in order to limit the risk of injury to the chest, between the hip and the shoulder. Each lateral airbag is fitted in the seat backrest frame, door side.

Deployment

The lateral airbags are deployed unilaterally in the event of a serious side impact applied to all or part of the side impact zone **B**, perpendicular to the longitudinal centreline of the vehicle on a horizontal plane and directed from the outside towards the inside of the vehicle.

The lateral airbag inflates between the hip and shoulder of the front occupant of the vehicle and the corresponding door trim panel.

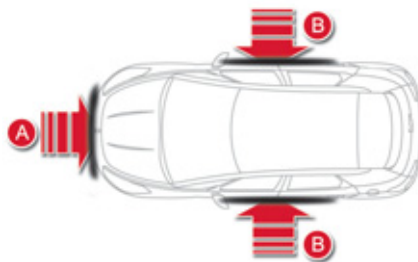

Impact detection zones

- A. Front impact zone.
- B. Side impact zone.

Curtain airbags

System which protects the driver and passengers (with the exception of the rear centre passenger) in the event of a serious side impact in order to limit the risk of injury to the side of the head.

Each curtain airbag is built into the pillars and the upper passenger compartment area.

Deployment

The curtain airbag is deployed at the same time as the corresponding lateral airbag in the event of a serious side impact applied to all or part of the side impact zone **B**, perpendicular to the longitudinal centreline of the vehicle on a horizontal plane and directed from the outside towards the inside of the vehicle.

The curtain airbag inflates between the front or rear occupant of the vehicle and the windows.

Operating fault



If this warning lamp comes on in the instrument panel, accompanied by an audible signal and a message in the instrument panel screen, contact a

CITROËN dealer or a qualified workshop to have the system checked. The airbags may no longer be deployed in the event of a serious impact.



In the event of a minor impact or bump on the side of the vehicle or if the vehicle rolls over, the airbag may not be deployed.

In the event of a rear or front collision, the curtain airbag is not deployed.

For the airbags to be fully effective, observe the following safety rules:

Sit in a normal upright position.

Wear a correctly adjusted seat belt.

Do not leave anything between the occupants and the airbags (a child, pet, object...). This could hamper the operation of the airbags or injure the occupants.

After an accident or if the vehicle has been stolen or broken into, have the airbag systems checked.

All work on the airbag system must be carried out by a CITROËN dealer or a qualified workshop.

Even if all of the precautions mentioned are observed, a risk of injury or of minor burns to the head, chest or arms when an airbag is deployed cannot be ruled out. The bag inflates almost instantly (within a few milliseconds) then deflates within the same time discharging the hot gas via openings provided for this purpose.

Front airbags

Do not drive holding the steering wheel by its spokes or resting your hands on the centre part of the wheel.

Passengers must not place their feet on the dashboard.

If possible, do not smoke as deployment of the airbags can cause burns or the risk of injury from a cigarette or pipe.

Never remove or pierce the steering wheel or hit it violently.

Lateral airbags

Use only approved covers on the seats, compatible with the deployment the lateral airbags. For information on the range of seat covers suitable for your vehicle, you can contact a CITROËN dealer.

Refer to the "Accessories" section.

Do not fix or attach anything to the seat backs (clothing...). This could cause injury to the chest or arms if the lateral airbag is deployed.

Do not sit with the upper part of the body any nearer to the door than necessary.

Curtain airbags

Do not fix or attach anything to the roof. This could cause injury to the head if the curtain airbag is deployed.

If fitted on your vehicle, do not remove the grab handles installed on the roof, they play a part in securing the curtain airbags.

197
Safety



008
Practical information

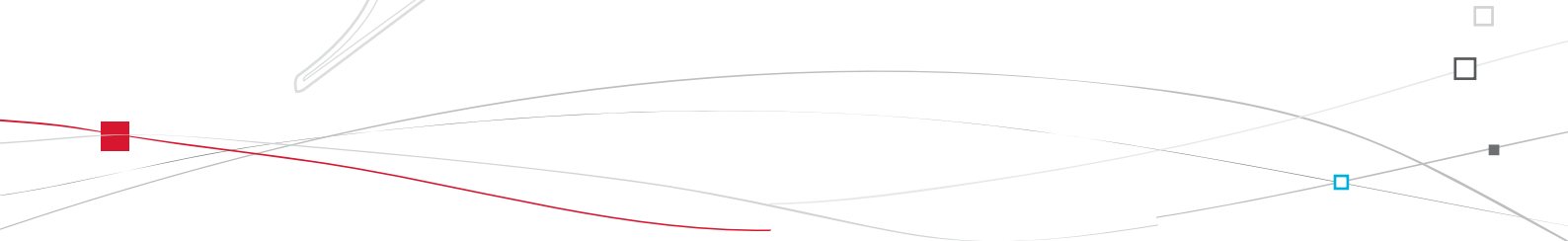



CITROËN

Temporary puncture repair kit

Complete system consisting of a compressor and a sealant cartridge which permits **temporary repair** of a tyre so that you can drive to the nearest garage. It is designed to repair most punctures which could affect the tyre, located on the tyre tread or shoulder.

Access to the kit

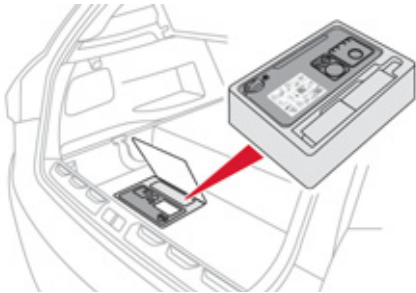

This kit is installed in the storage box, under the boot floor.

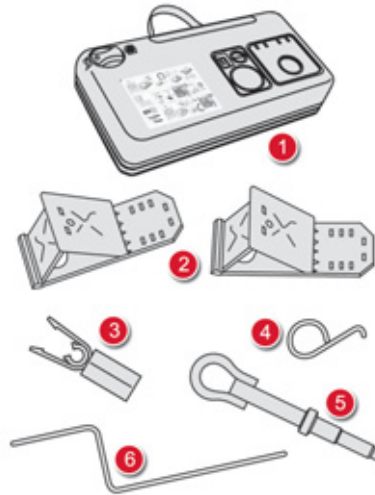

List of tools

All of these tools are specific to your vehicle and can vary according to equipment. Do not use them for other purposes.

1. 12 V compressor.
Contains a sealant cartridge for the temporary repair of a tyre and can also be used for adjusting tyre pressures.
2. Chocks* to block the wheels of the vehicle.
3. Bolt "covers"* tool.
For removing the wheel bolt protectors (covers) on alloy wheels.
4. Wheel finisher remover.
For removing the wheel finishers on alloy wheels.
5. Removable towing eye.
See "Towing the vehicle".
6. Electric parking brake emergency release control.
See "Electric parking brake" then "Emergency braking".

* Depending on country of sale or equipment.



Description of the kit



The tyre inflation pressures are given on this label.

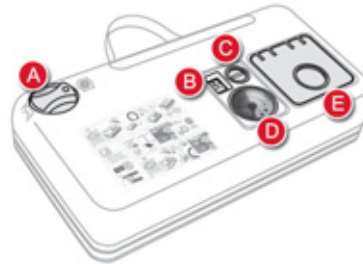

- A. "Sealant" or "Air" position selector.
- B. On "I" / off "O" switch.
- C. Deflation button.
- D. Pressure gauge (in bar or p.s.i.).
- E. Compartment housing:
 - a cable with adaptor for 12 V socket,
 - various inflation adaptors for accessories, such as balls, bicycle tyres...

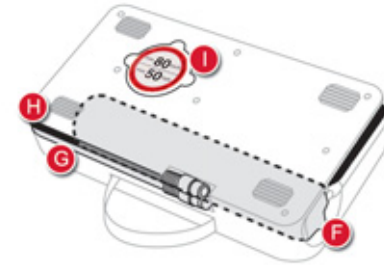

- F. Sealant cartridge.
- G. White pipe with cap for repair.
- H. Black pipe for inflation.
- I. Speed limit sticker.

i The speed limit sticker I must be affixed to the vehicle's steering wheel to remind you that a wheel is in temporary use. Do not exceed a speed of 50 mph (80 km/h) when driving with a tyre repaired using this type of kit.

Repair procedure

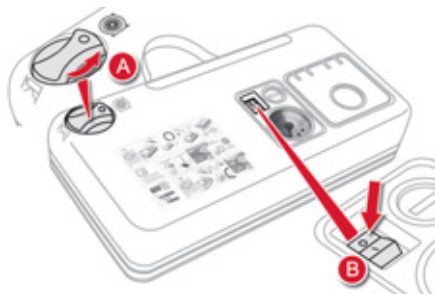

1. Sealing

- ☞ Switch off the ignition.
- ☞ Turn the selector **A** to the "sealant" position.
- ☞ Check that the switch **B** is in position "O".



i Avoid removing any foreign bodies which have penetrated into the tyre.

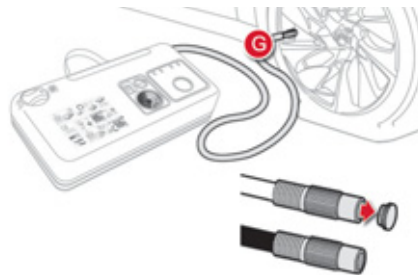

- ☞ Uncoil the white pipe **G** fully.
- ☞ Unscrew the cap from the white pipe.
- ☞ Connect the white pipe to the valve of the tyre to be repaired.

! Take care, this product is harmful (e.g. ethylene-glycol, colophony...) if swallowed and causes irritation to the eyes. Keep this product out of the reach of children.



- ☞ Connect the compressor's electric plug to the vehicle's 12 V socket.
- ☞ Start the vehicle and leave the engine running.

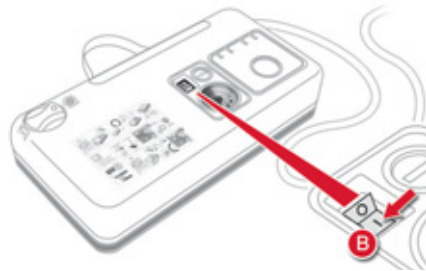

- ☞ Switch on the compressor by moving the switch **B** to position "I" until the tyre pressure reaches 2.0 bars. The sealant is injected into the tyre under pressure; do not disconnect the pipe from the valve during this operation (risk of splashing).

i Do not start the compressor before connecting the white pipe to the tyre valve: the sealant product would be expelled through the pipe.

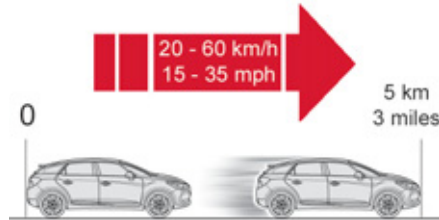

- ☞ Remove the kit and screw the cap back on the white pipe. Take care to avoid staining your vehicle with traces of fluid. Keep the kit to hand.
- ☞ Drive immediately for approximately three miles (five kilometres), at reduced speed (between 15 and 35 mph (20 and 60 km/h)), to plug the puncture.
- ☞ Stop to check the repair and the tyre pressure using the kit.

i If after around 5 to 7 minutes the pressure is not attained, this indicates that the tyre is not repairable; contact a CITROËN dealer or a qualified workshop for assistance.

i Tyre under-inflation detection

If the vehicle is fitted with tyre under-inflation detection, the under-inflation warning lamp will remain on after the wheel has been repaired until the system is reinitialised by a CITROËN dealer or a qualified workshop.

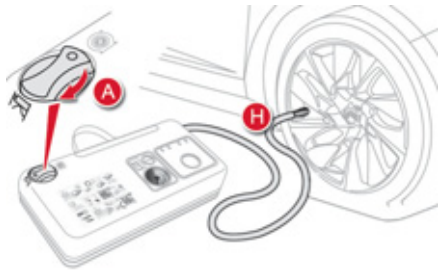

2. Inflation

- ☞ Turn the selector **A** to the "air" position.
- ☞ Uncoil the black pipe **H** fully.
- ☞ Connect the black pipe to the valve of the wheel.



- ☞ Connect the compressor's electric plug to the vehicle's 12 V socket.
- ☞ Start the vehicle again and leave the engine running.



As soon as possible, go to a CITROËN dealer or a qualified workshop. You must inform the technician that you have used this kit. After inspection, the technician will advise you on whether the tyre can be repaired or if it must be replaced.

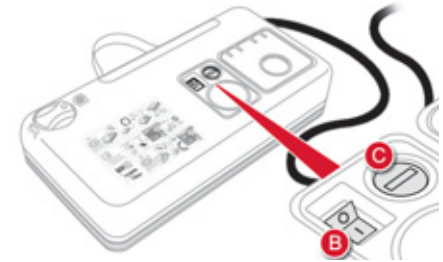

- ☞ Adjust the pressure using the compressor (to inflate: switch **B** in position "**I**"; to deflate: switch **B** in position "**O**" and press button **C**), in accordance with the vehicle's tyre pressure label (located on the left hand door aperture).
- A loss of pressure indicates that the puncture has not been fully plugged; contact a CITROËN dealer or qualified workshop for assistance.
- ☞ Remove and stow the kit.
 - ☞ Drive at reduced speed (50 mph [80 km/h] max) limiting the distance travelled to approximately 120 miles (200 km).

Removing the cartridge



- ☞ Stow the black pipe.
- ☞ Detach the angled base from the white pipe.
- ☞ Support the compressor vertically.
- ☞ Unscrew the cartridge from the bottom.

! Beware of discharges of fluid.
The expiry date of the fluid is indicated on the cartridge.
The sealant cartridge is designed for single use; even if only partly used, it must be replaced.
After use, do not discard the cartridge into the environment, take it to an authorised waste disposal site or a CITROËN dealer.
Do not forget to obtain a new sealant cartridge, available from CITROËN dealers or from a qualified workshop.

Checking tyre pressures / inflating accessories

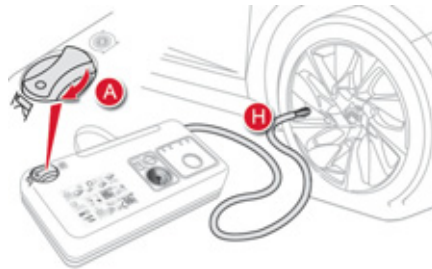

You can also use the compressor, without injecting any product, to:

- check or adjust the pressure of your tyres,
- inflate other accessories (balls, bicycle tyres...).

- ☞ Turn the selector **A** to the "Air" position.
- ☞ Uncoil the black pipe **H** fully.
- ☞ Connect the black pipe to the valve of the wheel or accessory.
If necessary, fit one of the adaptors supplied with the kit first.

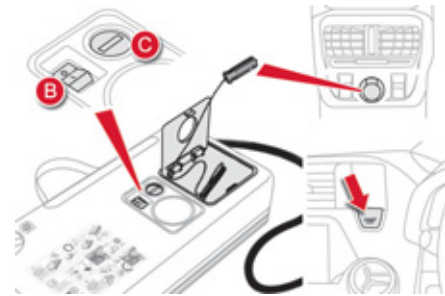

- ☞ Connect the compressor's electrical connector to the vehicle's 12 V socket.
- ☞ Start the vehicle and let the engine run.
- ☞ Adjust the pressure using the compressor (to inflate: switch **B** in position "I"; to deflate: switch **B** in position "O" and press button **C**), according to the vehicle's tyre pressure label or the accessory's pressure label.
- ☞ Remove the kit then stow it.

Changing a wheel

Procedure for changing a faulty wheel for the spare wheel using the tools provided with the vehicle*.

Access to the tools





The tools are installed in the boot under the floor.

 When using lifting equipment (a jack for example), take care to use the jacking points provided, so as to avoid damaging the high voltage cables.

Tyre under-inflation detection

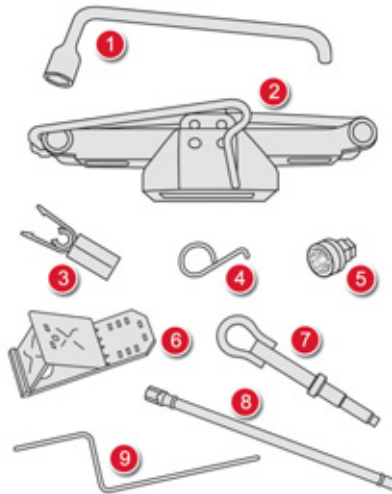
The spare wheel is not fitted with a sensor. The punctured wheel must be repaired by a CITROËN dealer or a qualified workshop.



 Before doing any work on your vehicle, switch off the ignition (**Ready** lamp off) to avoid any risk of injury resulting from automatic operation of the engine.

List of tools*

All of these tools are specific to your vehicle and can vary according to the level of equipment. Do not use them for other purposes.

1. Wheelbrace.
For removing the wheel trim and removing the wheel bolts.
2. Jack with integral handle.
For raising the vehicle.
3. "Bolt cover" tool.
For removing the bolt protectors (covers) on alloy wheels.
4. Wheel trim remover.
For removing the alloy wheel finishers.
5. Socket for the security bolts (located in the glove box).
For adapting the wheelbrace to the special "security" bolts.
6. Wheel chocks for blocking the vehicle's wheels.
7. Towing eye.
See the "Towing the vehicle" section.
8. Extension spanner.
For slackening/tightening the spare wheel carrier nut.
9. Emergency release control for the electric parking brake.
See the "Electric parking brake" section, "Emergency braking".

* According to country of sale.

Access to the spare wheel

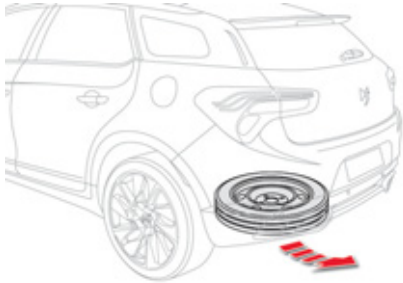

The spare wheel is supported by a cable-driven carrier underneath the vehicle.

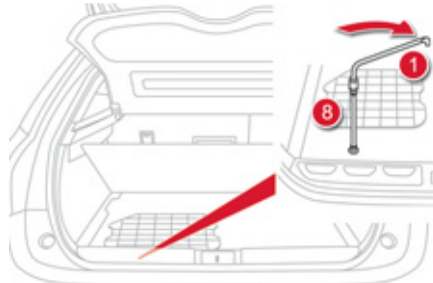

Taking out the wheel

- ☞ Raise the floor to reveal the spare wheel carrier drive nut.
- ☞ Turn this drive nut fully **clockwise**, using the wheelbrace **1** and the extension **8**, to unwind the carrier cable.

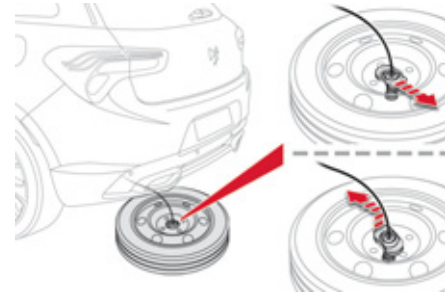

- ☞ Detach the wheel from the rear of the vehicle.
- ☞ Remove the hook with its connection plate to release the wheel, as shown in the illustration.
- ☞ Pull out the wheel.

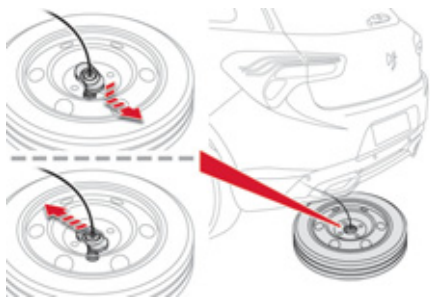

Putting the wheel back in place

☞ Pass the hook with its connection plate into the wheel, as illustrated.



☞ Raise the wheel underneath the vehicle by turning the carrier drive nut **anticlockwise** using the wheelbrace **1** and the extension **8**.

☞ Tighten fully and check that the wheel is horizontally flush against the floor.



Removing a wheel

i Parking the vehicle

Immobilise the vehicle where it does not block traffic: the ground must be level, stable and not slippery.

Apply the parking brake unless it has been programmed to automatic mode, switch off the ignition and engage first gear* to block the wheels.

Check that the braking warning lamp and the **P** warning lamp in the parking brake control lever come on.

The occupants must get out of the vehicle and wait where they are safe. Never go underneath a vehicle raised using a jack; use an axle stand.

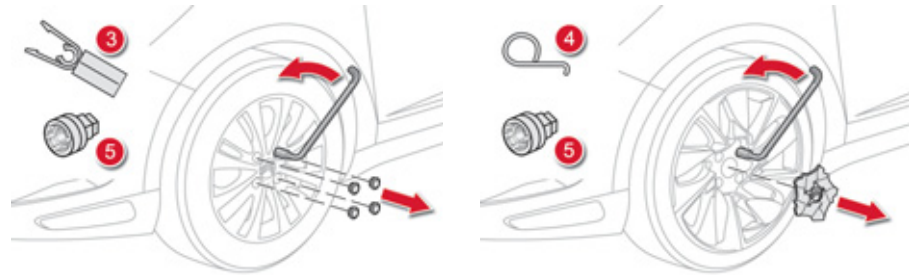

List of operations

- ☞ Depending on equipment, remove the cover from from each of bolts using the tool **3** or remove the hub cap using tool **4**.
- ☞ Fit the security socket **5** on the wheelbrace **1** to slacken the security bolt (if fitted).
- ☞ Slacken the other bolts (no more than a 1/4 turn) using the wheelbrace **1** only.

* position **R** for the electronic gearbox system;
P for the automatic gearbox.

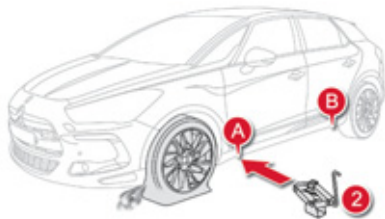

- ☞ Place the jack **2** in contact with one of the two front **A** or rear **B** locations provided on the underbody, whichever is closest to the wheel to be changed.

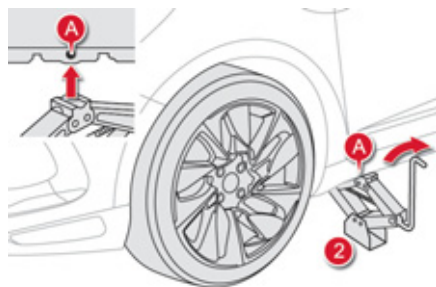

- ☞ Extend the jack **2** until its base plate is in contact with the ground. Ensure that the centreline of the jack base plate is directly below the location **A** or **B** used.



- ☞ Raise the vehicle until there is sufficient space between the wheel and the ground to admit the spare (not punctured) wheel easily.
- ☞ Remove the bolts and store them in a clean place.
- ☞ Remove the wheel.

Fitting a wheel



Fitting the "space-saver" spare wheel

If your vehicle is fitted with alloy wheels, when tightening the bolts on fitting, it is normal to notice that the washers do not come into contact with the "space-saver" spare wheel. The wheel is secured by the conical surface of each bolt.

After changing a wheel

To correctly store the punctured wheel in the boot (**not in the location of the space-saver wheel**), first remove the central cover.



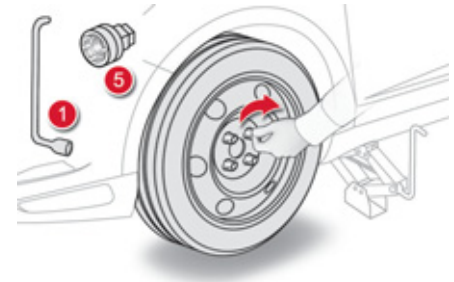

When using the "space-saver" type spare wheel, do not exceed 50 mph (80 km/h).

Have the tightening of the bolts and the pressure of the spare wheel checked by a CITROËN dealer or a qualified workshop without delay.

Have the punctured wheel repaired and refitted to the vehicle as soon as possible.



List of operations

-  Put the wheel in place on the hub.
-  Screw in the bolts fully by hand.
-  Pre-tighten the security bolt using the wheelbrace **1** fitted with the security socket **5**.
-  Pre-tighten the other bolts using the wheelbrace **1** only.

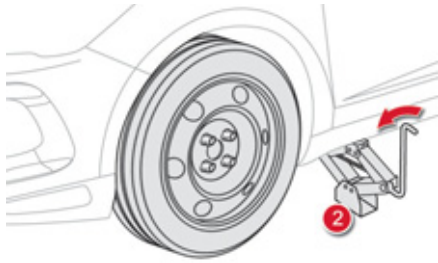

- ☞ Lower the vehicle fully.
- ☞ Fold the jack **2** and detach it.

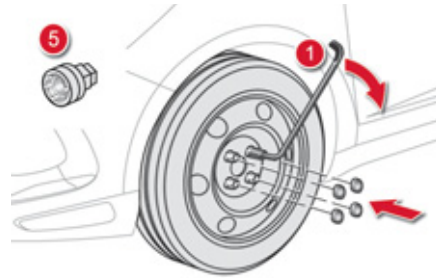

- ☞ Tighten the security bolt using the wheelbrace **1** fitted with the security socket **5**.
- ☞ Tighten the other bolts using the wheelbrace **1** only.
- ☞ Refit the bolt covers on each of the bolts or the hub cap (depending on equipment).
- ☞ Store the tools in the box.

Snow chains

In wintry conditions, snow chains improve traction as well as the behaviour of the vehicle when braking.

i The snow chains must be fitted only to the front wheels. They must never be fitted to "space-saver" type spare wheels.

Use only the chains designed to be fitted to the type of wheel fitted to your vehicle:

Original tyre size	Maximum link size.
215/60 R16	9 mm
225/50 R17	
235/45 R18	not chainable
235/40 R19	

For more information on snow chains, contact a CITROËN dealer or a qualified workshop.

i Take account of the legislation in force in your country on the use of snow chains and the maximum running speed authorised.

Advice on installation

- ⚙** If you have to fit the chains during a journey, stop the vehicle on a flat surface on the side of the road.
- ⚙** Apply the parking brake and position any wheel chocks to prevent movement of your vehicle.
- ⚙** Fit the chains following the instructions provided by the manufacturer.
- ⚙** Move off gently and drive for a few moments, without exceeding 30 mph (50 km/h).
- ⚙** Stop your vehicle and check that the snow chains are correctly tightened.

i Avoid driving on roads that have been cleared of snow, to avoid damaging your vehicle's tyres and the road surface. It is recommended that before you leave, you practise fitting the snow chains on a level and dry surface. If your vehicle is fitted with alloy wheels, check that no part of the chain or its fixings is in contact with the wheel rim.

Changing a bulb

Front lamps



Before doing any work on your vehicle, switch off the ignition (**Ready** lamp off) to avoid any risk of injury resulting from automatic operation of the engine.

Model with xenon headlamps

1. **Main beam headlamps (H1-35W).**
2. **Directional dipped / directional headlamps (D1S-35W).**
3. **Daytime running lamps / sidelamps (light emitting diodes - LEDs).**
4. **Direction indicators (HY21-21W).**
5. **Directional foglamps (H11).**

Model with halogen headlamps

1. **Main beam headlamps (H1-55W).**
2. **Dipped beam headlamps (H7-55W).**
3. **Daytime running lamps/sidelamps (Light emitting diodes - LEDs).**
4. **Direction indicators (HY21-21W).**
5. **Directional foglamps (H11).**



Risk of electrocution

Xenon bulbs (D1S-35W) must be replaced by a CITROËN dealer or a qualified workshop.



For H7 type bulbs with lugs... take care to observe their correct installation so as to ensure the best lighting performance.

In some weather conditions (e.g. low temperature or humidity), the presence of misting on the internal surface of the glass of the headlamps and rear lamps is normal; it disappears after the lamps have been on for a few minutes.

- !** The headlamps are fitted with polycarbonate glass with a protective coating:
- ☞ **do not clean them using a dry or abrasive cloth, nor with a detergent or solvent product,**
 - ☞ use a sponge and soapy water or a pH neutral product,
 - ☞ when using a high pressure washer on persistent marks, do not keep the lance directed towards the lamps or their edges for too long, so as not to damage their protective coating and seals.

Changing a bulb should only be done after the headlamp has been switched off for a few minutes (risk of serious burns).

- ☞ Do not touch the bulb directly with your fingers, use a lint-free cloth.

It is imperative to use only anti-ultraviolet (UV) type bulbs to avoid damaging the headlamp.

Always replace a failed bulb with a new bulb with the same type and specification.

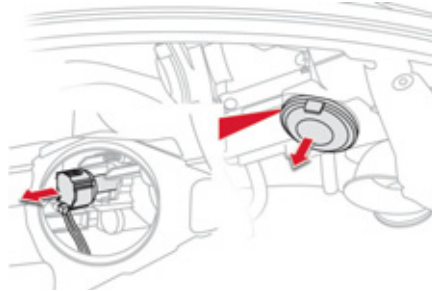

Main beam headlamps (xenon model)

- ☞ Remove the protective plastic cover by pulling on the tab.
- ☞ Remove the connector with the bulb by pressing on the lug at the bottom.
- ☞ Remove the bulb and change it.

For reassembly, carry out these operations in reverse order.

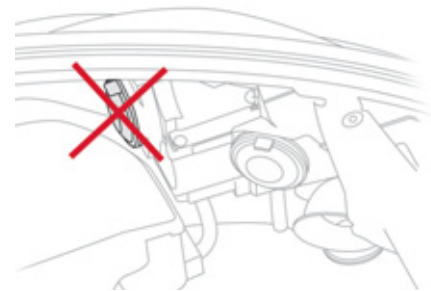

! Dipped beam headlamps (xenon model)

D1S xenon bulbs must be changed by a CITROËN dealer or a qualified workshop, as there is a risk of electrocution.

It is recommended that the D1S bulbs are changed at the same time when one of them fails.

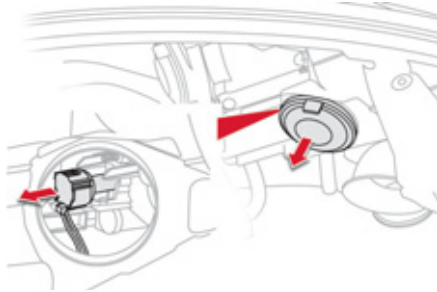

Main beam headlamps (halogen model)

- ☞ Remove the protective plastic cover by pulling on the tab.
- ☞ Remove the connector with the bulb by pressing on the lug at the bottom.
- ☞ Remove the bulb and change it.

For reassembly, carry out these operations in reverse order.

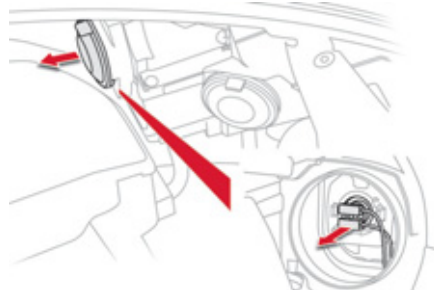

Dipped beam headlamps (halogen model)

- ☞ Remove the protective plastic cover by pulling on the tab.

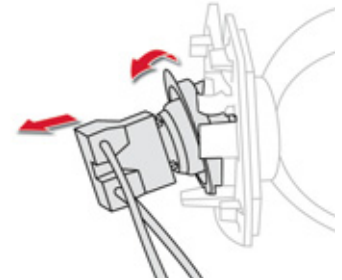

- ☞ Press on the top of the connector then pivot the assembly downwards.
- ☞ Remove the connector with the bulb.
- ☞ Remove the bulb and change it.

For reassembly, carry out these operations in reverse order, but engaging the bottom of the bulb first.

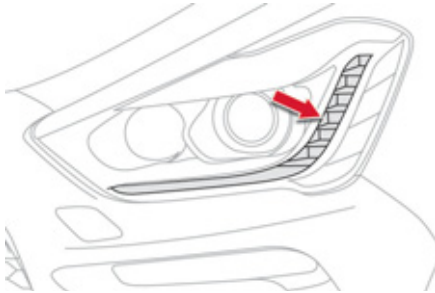

Daytime running lamps / sidelamps

For the replacement of this type of LED lamp and lighting guides, contact a CITROËN dealer or a qualified workshop.

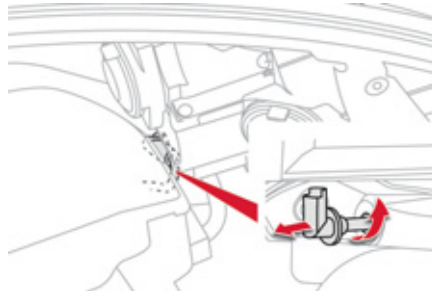

A replacement kit for the LEDs is available from CITROËN dealers.



Direction indicators

-  Faster flashing of a direction indicator warning lamp (left or right) indicates a failed bulb on that side.

The direction indicator bulb is located below the front lamp.

-  Turn the bulb holder a quarter turn and pull it out.
-  Remove the bulb and change it.

For reassembly, carry out these operations in reverse order.

You can also contact a CITROËN dealer or a qualified workshop for the replacement of these bulbs.



Door mirror spotlamps

You should contact a CITROËN dealer or a qualified workshop for the replacement of the light emitting diode - LED.

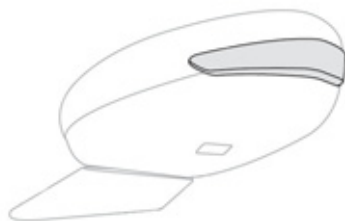

Integrated direction indicator side repeaters

You should contact a CITROËN dealer or a qualified workshop for the replacement of these bulbs.

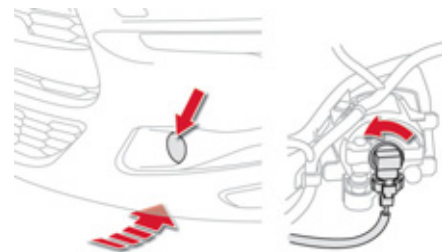

Front foglamps

- ☞ Remove the deflector under the body.
- ☞ Disconnect the bulb connector.
- ☞ Turn the bulb a quarter of a turn, withdraw and change it.

To refit, carry out these operations in reverse order.

To replace these bulbs you may also contact a CITROËN dealer or a qualified workshop.



Rear lamps

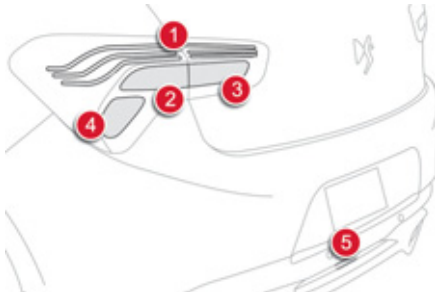

1. Sidelamps
(light emitting diodes - LEDs).
2. Direction indicators (PY21W amber).
3. Reversing lamps (P21W).
4. Brake lamps (P21W).
5. Foglamps (P21W).

Changing the light emitting diode-LED lamps

For replacement, contact a CITROËN dealer or qualified workshop.

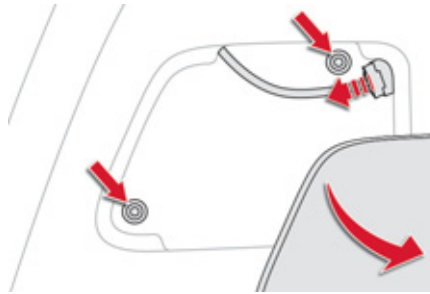

Direction indicators and brake lamps (on the wings)

- ☞ Open the boot then remove the access cover.
- ☞ Disconnect the lamp connector.
- ☞ Remove the two lamp fixing nuts.

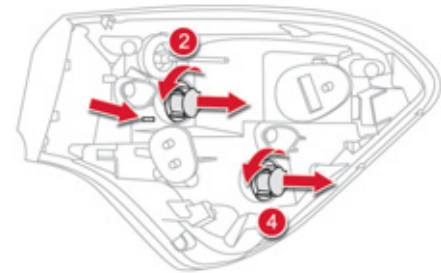

- ☞ Carefully remove the lamp unit from outside. The retaining clips unclip automatically.
- ☞ Turn the bulb holder a quarter of a turn and change the bulb.

For reassembly, carry out these operations in reverse order.

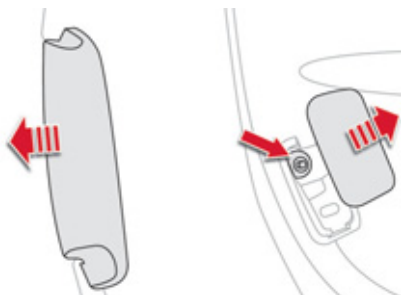

Reversing lamp (tailgate)

- ☞ Open the tailgate.
- ☞ Unclip the skirt of the lamp.
- ☞ Remove the access cover and the lamp fixing nut.

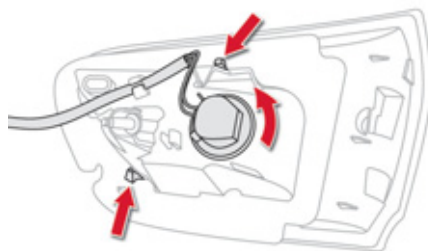

- ☞ Carefully remove the lamp from the outside. The retaining clips unclip automatically.
- ☞ Turn the bulb holder a quarter of a turn and replace the bulb.

For reassembly, carry out these operations in reverse order.

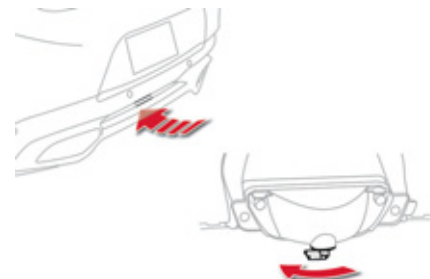

Foglamp

Access is by passing a hand under the bumper.

- ☞ Turn the bulb holder a quarter of a turn and pull it out.
- ☞ Change the bulb.

To refit, carry out these operations in reverse order.

You can also contact a CITROËN dealer or a qualified workshop for the replacement of these bulbs.

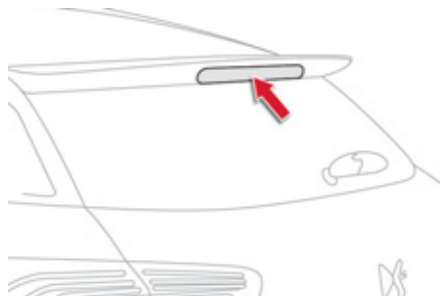

Third brake lamp (light emitting diodes - LEDs)

Contact a CITROËN dealer or qualified workshop.

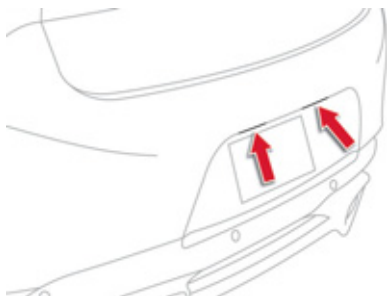

Number plate lamps

- ☞ Insert a thin screwdriver into the slot in the lens.
- ☞ Push it outwards to unclip it.
- ☞ Remove the lens.
- ☞ Pull the bulb out and change it.

Changing a fuse

Procedure for replacing a failed fuse with a new fuse to rectify a failure of the corresponding function.

Access to tooling

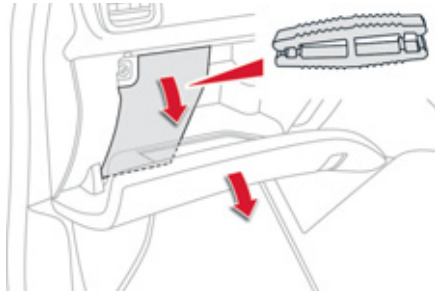

The fuse extraction tweezer is fitted to the back of the dashboard fusebox cover.

For access to it:

- ☞ remove the cover completely,
- ☞ remove the tweezer.

Changing a fuse



Good



Failed

Before changing a fuse, the cause of the failure must be identified and rectified.

- ☞ Identify the failed fuse by checking the condition of its filament.
- ☞ Use the special tweezer to extract the fuse from its housing.
- ☞ Always replace the failed fuse with a fuse of the same rating.
- ☞ Check that the number marked on the fusebox, the rating marked on the fuse and the following tables all agree.

i Installing electrical accessories

Your vehicle's electrical system is designed to operate with standard or optional equipment.

Before installing other electrical equipment or accessories on your vehicle, contact a CITROËN dealer or a qualified workshop.



CITROËN will not accept responsibility for the cost incurred in repairing your vehicle or for rectifying malfunctions resulting from the installation of accessories not supplied and not recommended by CITROËN and not installed in accordance with its instructions, in particular when the combined consumption of all of the additional equipment connected exceeds 10 milliamperes.

Dashboard fuses

The fusebox is placed in the lower dashboard (left-hand side).

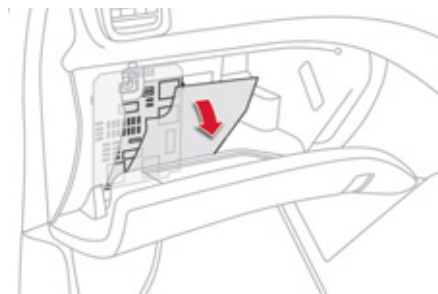

Access to the fuses

☞ Remove the cover.

Fuse N°	Rating (A)	Functions
F6 A or B	15	Audio system.
F8	3	Alarm.
F13	10	Front cigarette lighter, front 12 V socket.
F14	10	Rear 12 V socket.
F16	3	Rear map reading lamps.
F17	3	Courtesy mirror.
F28 A or B	15	Audio system.
F30	20	Rear wiper.
F32	10	Audio amplifier.

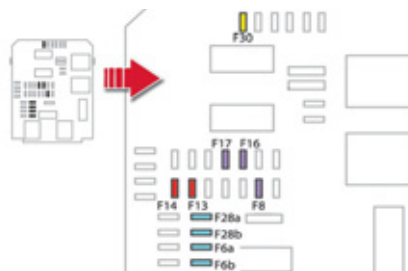

Engine compartment fuses

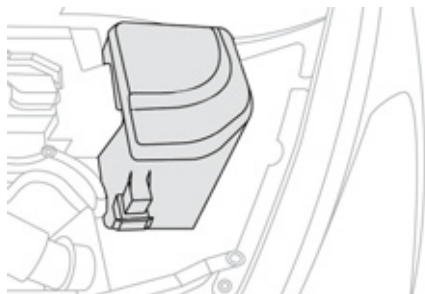

The fusebox is placed in the engine compartment near the battery.

Access to the fuses

- ☞ Unclip the cover.
- ☞ Change the fuse (see corresponding paragraph).
- ☞ When you have finished, close the cover carefully to ensure correct sealing of the fusebox.

Fuse N°	Rating (A)	Functions
F20	15	Front / rear screenwash pump.
F21	20	Headlamp wash pump.
F22	15	Horn.
F23	15	Right-hand main beam headlamp.
F24	15	Left-hand main beam headlamp.
F27	5	Left hand lamp mask.
F28	5	Right hand lamp mask.

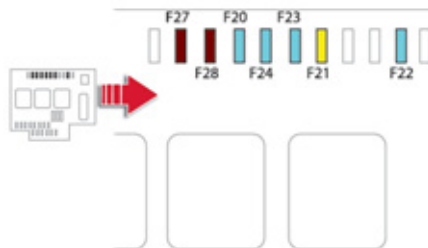

12 V battery

Procedure for starting the engine using another battery or charging a discharged battery.

Your vehicle is fitted with a conventional 12 V battery, located under the bonnet, in addition to the high voltage battery used by the hybrid system.

In certain conditions, if the 12 V battery is too discharged to activate the hybrid system, recharging from another conventional 12 V battery is possible.

Do not carry out this recharge if the **Ready** lamp is on.

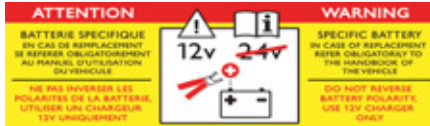

- ⚠ The presence of this label indicates the use of a 12 V lead-acid battery with special technology and specification, for which the involvement of a CITROËN dealer or qualified workshop is required when replacing or disconnecting the battery.
- Failure to observe this recommendation may cause premature wear of the battery.

Access to the battery

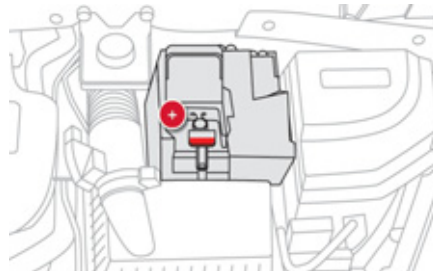

The battery is located under the bonnet. To gain access to it:

- ☞ open the bonnet using the interior release lever, then the exterior safety catch,
- ☞ remove the plastic cover on the (+) terminal,
- ☞ if necessary, unclip the fusebox to remove the battery.

- ⚠ Before doing any work on your vehicle, switch off the ignition (**Ready** lamp off) to avoid any risk of injury resulting from automatic operation of the engine.

Disconnecting the (+) cable

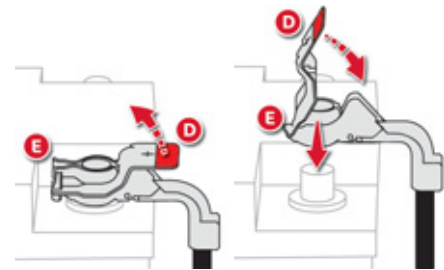

- ☞ Raise the locking tab **D** fully to release the cable terminal clamp **E**.

Reconnecting the (+) cable

- ☞ Position the open clamp **E** of the cable on the positive post (+) of the battery.
- ☞ Press vertically on the clamp **E** to position it correctly on the battery.
- ☞ Lock the clamp by spreading the positioning lug and then lowering the tab **D**.

- ⚠ Do not apply excessive force on the tab as locking will not be possible if the clamp is not positioned correctly; start the procedure again.

Starting using another battery

When your vehicle's battery is discharged, the engine can be started using a slave battery (external or on another vehicle) and jump lead cables.

- ⚠ First check that the slave battery has a nominal voltage of 12 V and a capacity at least equal to that of the discharged battery.
Do not try to start the engine by connecting a battery charger.
Do not disconnect the (+) terminal when the engine is running.

- 🔧 Connect the red cable to the positive terminal (+) of the flat battery **A**, then to the positive terminal (+) of the slave battery **B**.
- 🔧 Connect one end of the green or black cable to the negative terminal (-) of the slave battery **B** (or earth point on the other vehicle).
- 🔧 Connect the other end of the green or black cable to the earth point **C** on the broken down vehicle (or on the engine mounting).
- 🔧 Start the engine of the vehicle with the good battery and leave it running for a few minutes.

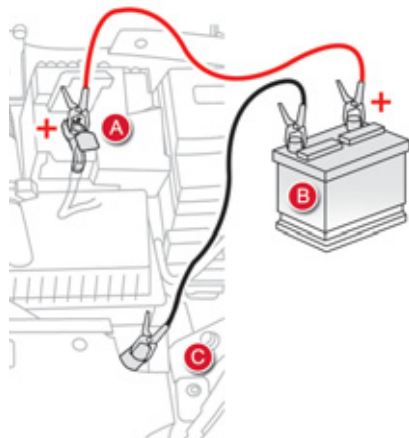



- 🔧 Operate the starter on the broken down vehicle and let the engine run. If the engine does not start straight away, switch off the ignition and wait a few moments before trying again.
- 🔧 Wait until the engine returns to idle then disconnect the jump lead cables in the reverse order.

Charging the battery using a battery charger

- 🔧 Disconnect the battery from the vehicle.
- 🔧 Follow the instructions for use provided by the manufacturer of the charger.
- 🔧 Connect the battery starting with the negative terminal (-).
- 🔧 Check that the terminals and connectors are clean. If they are covered with sulphate (whitish or greenish deposit), remove them and clean them.

- 📘 After refitting the battery, the Stop & Start system will only be active after several hours depending on the climatic conditions and the state of charge of the battery (up to about 8 hours).

 The batteries contain harmful substances such as sulphuric acid and lead. They must be disposed of in accordance with regulations and must not, in any circumstances, be discarded with household waste. Take used remote control batteries and vehicle batteries to a special collection point.

 It is advisable to disconnect the battery if the vehicle is to be left unused for more than one month.

 Protect your eyes and face before handling the battery. All operations on the battery must be carried out in a well ventilated area and away from naked flames and sources of sparks, so as to avoid the risk of explosion or fire. Do not try to charge a frozen battery; the battery must first be thawed out to avoid the risk of explosion. If the battery has been frozen, before charging have it checked by a CITROËN dealer or a qualified workshop who will check that the internal components have not been damaged and the casing is not cracked, which could cause a leak of toxic and corrosive acid. Do not reverse the polarity and use only a 12 V charger. Do not disconnect the terminals while the engine is running. Do not charge the batteries without disconnecting the terminals first. Wash your hands afterwards.

Do not push the vehicle to start the engine if the vehicle is fitted with the electronic gearbox.

Do not push the vehicle to start the engine.

Before disconnecting the battery

Wait 2 minutes after switching off the ignition before disconnecting the battery. Close the windows and the doors before disconnecting the battery.

Following reconnection of the battery

Following reconnection of the battery, switch on the ignition and wait 1 minute before starting to permit initialisation of the electronic systems. However, if problems remain following this operation, contact a CITROËN dealer or a qualified workshop. Referring to the corresponding section, you must yourself reinitialise (depending on version):

- the remote control key,
- the electric blind(s),
- ...

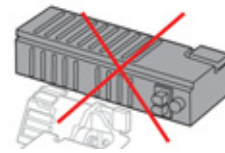

 Do not attempt to charge the high voltage battery.

Load reduction mode

System which manages the use of certain functions according to the level of charge remaining in the battery.

When the vehicle is being driven, the load reduction function temporarily deactivates certain functions, such as the air conditioning, the heated rear screen...

The deactivated functions are reactivated automatically as soon as conditions permit.

Energy economy mode

System which manages the duration of use of certain functions to conserve a sufficient level of charge in the battery.

After the engine has stopped, you can still use functions such as the audio and telematics system, windscreen wipers, dipped beam headlamps, courtesy lamps, etc. for a maximum combined duration of about forty minutes.

Switching to economy mode

A message then appears in the instrument panel screen indicating that the vehicle has switched to economy mode and the active functions are put on standby.

If a telephone call is being made at this time, it will be maintained for around 10 minutes with the Bluetooth hands-free system of your audio system.



In this energy economy mode and when starting up the hybrid system, it may take a few seconds before the **Ready** lamp comes on.

Exiting economy mode

These functions are reactivated automatically next time the vehicle is driven.

In order to restore the use of these functions immediately, start the engine and let it run:

- for less than ten minutes, to use the equipment for approximately five minutes,
- for more than ten minutes, to use the equipment for up to approximately thirty minutes.

Let the engine run for the duration specified to ensure that the battery charge is sufficient.

Do not repeatedly and continuously restart the engine in order to charge the battery.

A flat battery prevents the engine from starting (refer to the "Battery" section).

Changing a wiper blade

Before removing a front wiper blade

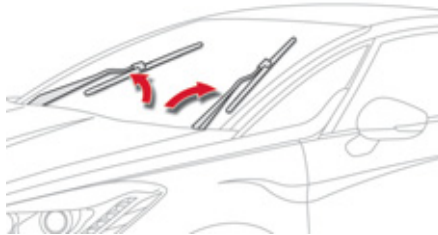

- ☞ Within one minute after switching off the ignition, operate the wiper stalk to position the wiper blades vertically on the windscreen.

Removing

- ☞ Raise the corresponding wiper arm.
- ☞ Unclip the wiper blade and remove it.

Fitting

- ☞ Put the corresponding new wiper blade in place and clip it.
- ☞ Fold down the wiper arm carefully.

After fitting a front wiper blade

- ☞ Switch on the ignition.
- ☞ Operate the wiper stalk again to park the wiper blades.

Recovering the vehicle on a flat-bed

Procedure for having your vehicle recovered on a flat bed lorry or trailer.

Always recover the vehicle on a flat bed lorry or trailer.

Never tow the vehicle with the four wheels on the ground (or the front or rear wheels only), you risk damaging the transmission.

Place the gear selector in position **N** and switch off the engine (**Ready** lamp off).

Access to the tools

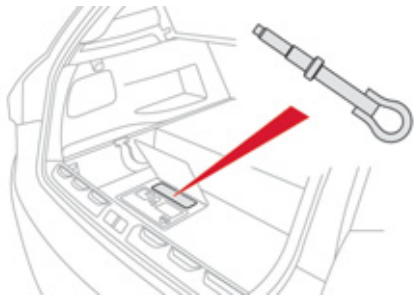

The towing eye is installed in the boot under the floor.

To gain access to it:

- ☞ open the boot,
- ☞ remove the towing eye, located in the tool box.

From the front

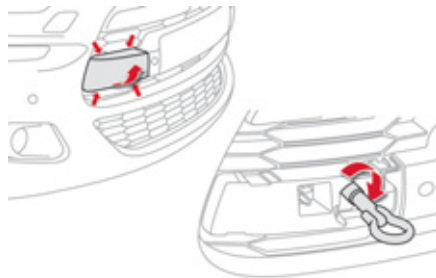

- ☞ On the front bumper, unclip the cover by pressing at the bottom to disengage the securing lugs.
- ☞ Screw the towing eye in fully.
- ☞ Install the towing system.
- ☞ Switch on the hazard warning lamps.

From the rear

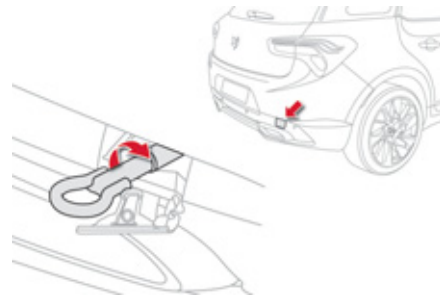

- ☞ On the rear bumper, unclip the cover by levering at the left with the point of the towing eye.
- ☞ Screw the towing eye in fully.
- ☞ Install the towing system.
- ☞ Switch on the hazard warning lamps.



- ☞ Place the gear selector in neutral - position **N**.

Failure to observe this special condition could result in damage to certain braking components and the absence of braking assistance the next time the engine is started.



- ☞ When towing with the engine off, there is no longer any braking or steering assistance.

Vehicle recovery

Before doing any work, with the ignition on, press the brake pedal and put the gear selector to position **N**, then switch off the hybrid system.

If necessary because access to the vehicle is difficult, it can be moved a few dozen metres at a speed not exceeding 6 mph (10 km/h).

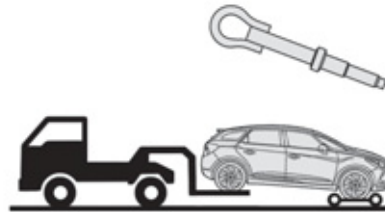
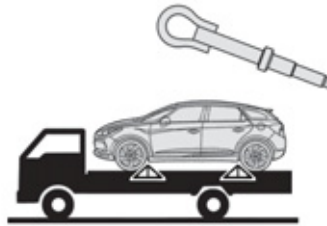

The front or rear wheels must not be on the ground, use a flat-bed lorry or trailer to recover the vehicle.

Use the towing eyes only to pull a vehicle out or to pull it onto a flat-bed.

Towing a trailer

Maximum trailer weight

The towing weight is limited: refer to the "Technical data" section.



Towbar suitable for the attachment of a trailer or installation of a bicycle carrier, with additional lighting and signalling.

Your vehicle is primarily designed for transporting people and luggage, but it may also be used for towing a trailer.

i When not towing a trailer, remove the quickly-detachable tow ball before driving, so as to avoid masking the central rear lamp.



We recommend the use of genuine CITROËN towbars and their harnesses that have been tested and approved from the design stage of your vehicle, and that the fitting of the towbar is entrusted to a CITROËN dealer or a qualified workshop.

If the towbar is not fitted by a CITROËN dealer, it is imperative that it is fitted in accordance with the vehicle manufacturer's instructions.



Driving with a trailer places greater demands on the towing vehicle and the driver must take particular care.

Driving advice

Distribution of loads

- ☞ Distribute the load in the trailer so that the heaviest items are as close as possible to the axle and the nose weight approaches the maximum permitted without exceeding it.

Air density decreases with altitude, thus reducing engine performance. Above 1 000 metres, the maximum towed load must be reduced by 10 % for every 1 000 metres of altitude.

Refer to the "Technical data" section for details of the weights and towed loads which apply to your vehicle.

Side wind

- ☞ Take into account the increased sensitivity to side wind.

Cooling

Towing a trailer on a slope increases the temperature of the coolant.

As the fan is electrically controlled, its cooling capacity is not dependent on the engine speed.

- ☞ To lower the engine speed, reduce your speed.

The maximum towed load on a long incline depends on the gradient and the ambient temperature.

In all cases, keep a check on the coolant temperature.



- ☞ If the warning lamp and the **STOP** warning lamp come on, stop the vehicle and switch off the engine as soon as possible.

Braking

Towing a trailer increases the braking distance. To avoid overheating of the brakes on a long mountain type of descent, the use of engine braking is recommended.

Tyres

- ☞ Check the tyre pressures of the towing vehicle and of the trailer, observing the recommended pressures.

Lighting

- ☞ Check the electrical lighting and signalling on the trailer.



The rear parking sensors will be deactivated automatically if a genuine CITROËN towbar is used.



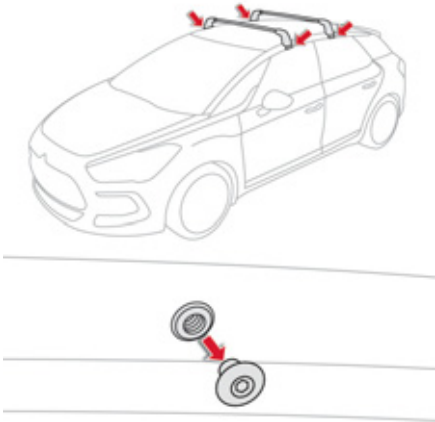

Fitting roof bars

When fitting transverse roof bars, take care to position them correctly:



- 🔧 Remove the cap using an allen™ key.
- 🔧 Put the bars into position then fit and tighten the securing screws.

 Use accessories recommended by CITROËN observing the manufacturer's recommendations and fitting instructions so as to avoid the risk of damaging the body (deformation, scratches, ...).

 Maximum authorised load evenly distributed on the roof bars, for a loading height not exceeding 40 cm (with the exception of bicycle carriers): **70 kg**. If the height exceeds 40 cm, adapt the speed of the vehicle to the profile of the road to avoid damaging the roof bars and the fixings on the roof. Be sure to refer to national legislation in order to comply with the regulations for transporting objects which are longer than the vehicle.

Accessories

A wide range of accessories and genuine parts is available from the CITROËN dealer network. These accessories and parts have been tested and approved for reliability and safety. They are all adapted to your vehicle and benefit from CITROËN's recommendation and warranty.

"Comfort":

door deflectors, side window blinds, rear screen blind, isotherm module, coat hanger fixed to head restraint, mobile reading lamp, mirror for caravan, parking sensors...

"Styling":

gear lever knobs, aluminium foot rest, alloy wheels, chrome mirror shells, chrome door aperture finishers...

"Protection":

mats*, seat covers compatible with lateral airbags, mud flaps, door protective mouldings, bumper protection strips, vehicle cover... The rear bodywork has been designed to avoid spray.

"Transport systems":

child seats and booster cushions, boot carpet, boot liner, boot net, boot spacers, transverse roof bars, bicycle carrier, ski carrier, roof boxes, towbars, wiring harnesses...

If a towbar and wiring harness are fitted outside the CITROËN dealer network, the installation must be done using the vehicle's electrical pre-equipment and fitted following the manufacturer's recommendations.

"Security and safety":

anti-intrusion alarm, anti-tilt unit, stolen vehicle tracking system, child seats and booster cushions, breathalyser, first aid kit, fire extinguisher, warning triangle, high visibility vest, wheel security bolts, snow chains, non-slip covers...

- * To avoid any risk of jamming the pedals:
 - ensure that mats are correctly positioned and secured,
 - never fit one mat on top of another.



"Multimedia":

audio systems, steering mounted audio controls, speakers, Hi-Fi module, Bluetooth hands-free system, portable satellite navigation system, semi-integral support bracket for portable navigation system, driving assistance systems, USB Box, reversing camera, portable video screen, portable video support bracket, 230 V/50 Hz socket, 230 V/12 V adaptor, Wi-Fi on board...

By visiting a CITROËN dealer you can also obtain cleaning and maintenance products (interior and exterior) - including ecological products in the "TECHNATURE" range, products for topping up (screenwash...), paint touch-up pens and aerosols for the exact colour of your vehicle, refills (sealant cartridge for the temporary puncture repair kit...), ...

Installation of radio communication transmitters

Before installing any after-market radio communication transmitter, you can contact a CITROËN dealer for the specification of transmitters which can be fitted (frequency, maximum power, aerial position, specific installation requirements), in line with the Vehicle Electromagnetic Compatibility Directive (2004/104/EC).

 Depending on the legislation in force in the country, it may be compulsory to have a high visibility safety vest, warning triangle and spare bulbs and fuses available in the vehicle.

 The fitting of electrical equipment or accessories which are not recommended by CITROËN may result in a failure of your vehicle's electronic system and excessive electrical consumption.
Please note this precaution. You are advised to contact a CITROËN representative to be shown the range of recommended equipment and accessories.

009
Checks

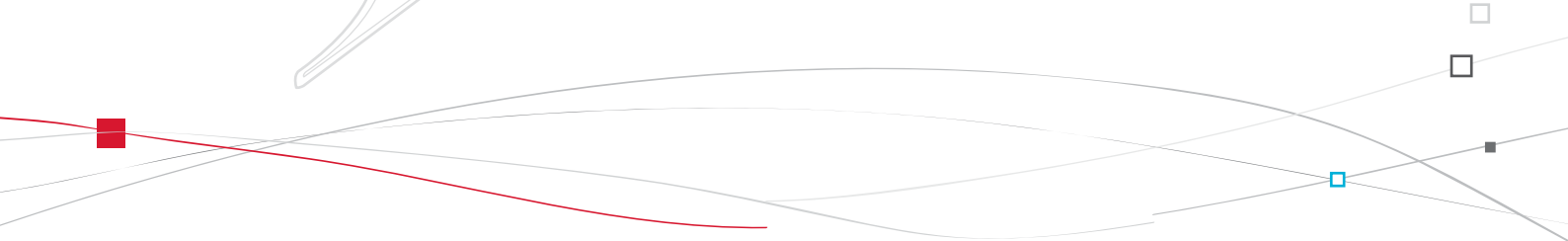



TOTAL & CITROËN

**PARTNERS IN PERFORMANCE
AND PROTECTING
THE ENVIRONMENT**

Innovation in the search for performance

For over 40 year, the TOTAL Research and Development departments have developed for CITROËN, lubricants to match the latest technical innovations on CITROËN vehicles, both for competition and for everyday motoring. For you, this is an assurance that you will obtain of the best performance for your engine.

Optimum protection for your engine

By having your CITROËN vehicle serviced with TOTAL lubricants, you are contributing towards improving the life and performances of your engine, while also protecting the environment.



CITROËN prefers TOTAL



Opening the bonnet

⚠ Before doing anything under the bonnet, switch off the ignition (**Ready** lamp off) to avoid any risk of injury resulting from automatic operation of the engine.

⚠ Never touch, handle or remove the orange "high voltage" cables.

⚠ The use of a high pressure jet wash under the bonnet is strictly prohibited, in order to avoid damage to the electric components.



Opening

☞ **From inside:** pull the release lever, located on the left below the dashboard, towards you.

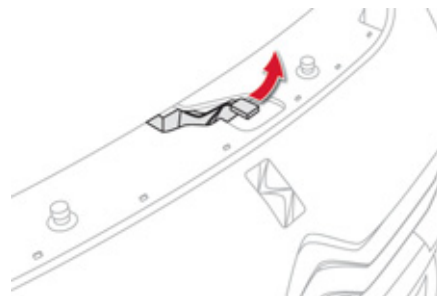

☞ **From the outside:** lift the safety catch and raise the bonnet. A bonnet strut opens the bonnet and holds it open.

Closing

☞ Lower the bonnet and release it at the end of its travel.

☞ Check that it is latched correctly.

Diesel engine

The various caps and covers allow access for checking the levels of the various fluids, for replacing certain components and for priming the fuel system.

1. Power steering reservoir.
2. Screenwash and headlamp wash reservoir.
3. Coolant reservoir.
4. Brake fluid reservoir.
5. Battery / Fuses.
6. Fusebox.
7. Air filter.
8. Engine oil dipstick.
9. Engine oil filler cap.
10. Priming pump.
11. Bleed screw.

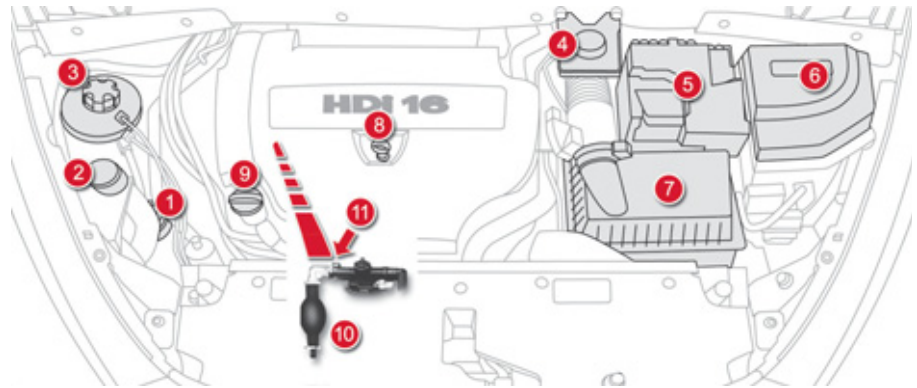



HDI 160 PEF 6-SPEED ELECTRONIC GEARBOX

Running out of fuel (Diesel)

On vehicle fitted with HDi engines, the fuel system must be primed if you run out of fuel; refer to the corresponding engine compartment view.











 If the tank on your vehicle is fitted with a misfuel prevention device, refer to the "Misfuel prevention (Diesel)" section.

 If the engine does not start first time, don't keep trying. Start the procedure again from the beginning.

 Before doing anything under the bonnet, switch off the ignition (**Ready** lamp off) to avoid any risk of injury resulting from automatic operation of the engine.

2 litre HDi engine



-  Fill the fuel tank with at least five litres of Diesel.
-  Open the bonnet.
-  If necessary, unclip the style cover for access to the priming pump.
-  Slacken the bleed screw.
-  Squeeze and release the priming pump repeatedly until fuel appears in the transparent pipe.
-  Tighten the bleed screw.
-  Operate the starter until the engine starts (if the engine fails to start at the first attempt, wait around 15 seconds before trying again).
-  If the engine fails to start after a few attempts, operate the priming pump again, then the starter.
-  Put the style cover back in position and clip it in place, ensuring that it has clipped correctly.
-  Close the bonnet.

Checking levels

If a level drops significantly, have the corresponding system checked by a CITROËN dealer or a qualified workshop.

Check all of these levels regularly, in line with the servicing booklet and the requirements of the warranties. Top them up if necessary, unless otherwise indicated.



Take care when working under the bonnet, as certain areas of the engine may be extremely hot (risk of burns) and the cooling fan could start at any time (even with the ignition off).



Before doing anything under the bonnet, switch off the ignition (**Ready** lamp off) to avoid any risk of injury resulting from automatic operation of the engine.

Oil level



The check is carried out either when the ignition is switched on using the oil level indicator in the instrument panel, or using the dipstick.

It will only be correct if the vehicle is on level ground and the engine has been off for more than 30 minutes.



It is normal to top up the oil level between two services (or oil changes). CITROËN recommends that you check the level, and top up if necessary, every 3 000 miles (5 000 kms).

After topping up the oil, the check when switching on the ignition with the oil level indicator in the instrument panel is not valid during the 30 minutes after topping up.

Engine oil change

Refer to the servicing and warranty booklet for details of the interval for this operation. In order to maintain the reliability of the engine and emission control system, the use of additives in the engine oil is prohibited.

Oil specification

The oil must be the correct grade for your engine and conform to the manufacturer's recommendations.



Brake fluid level



The brake fluid level should be close to the "MAX" mark. If it is not, check the brake pad wear.

Changing the fluid

Refer to the servicing and warranty booklet for details of the interval for this operation.

Fluid specification

The brake fluid must conform to the manufacturer's recommendations and meet the DOT3 or DOT4 standard.

Power steering fluid level



The power steering fluid level should be close to the "MAX" mark. With the engine cold, unscrew the cap to check the level.

Coolant level



The coolant level should be close to the "MAX" mark but should never exceed it.

When the engine is warm, the temperature of the coolant is regulated by the fan. This can operate with the ignition off.

On vehicles which are fitted with a particle emission filter, the fan may operate after the vehicle has been switched off, even if the engine is cold.



In addition, as the cooling system is pressurised, wait at least one hour after switching off the engine before carrying out any work.

To avoid any risk of scalding, unscrew the cap by two turns to allow the pressure to drop. When the pressure has dropped, remove the cap and top up the level.

Changing the coolant

The coolant does not have to be changed.

Fluid specification

The coolant must conform to the manufacturer's recommendations.



Before doing anything under the bonnet, switch off the ignition (**Ready** lamp off) to avoid any risk of injury resulting from automatic operation of the engine.

Screenwash / headlamp wash level

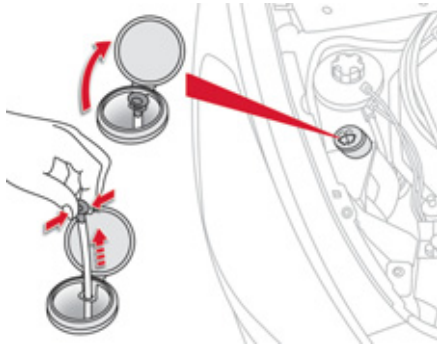

To check the level or top up the fluid on vehicle fitted with headlamp washers, immobilise the vehicle and switch of the engine.

- ☞ Before opening the bonnet, ensure that the engine has completely stopped.
- ☞ Open the screenwash reservoir filler cap.

- ☞ Take and pinch the level gauge to block its breather.
- ☞ Remove the gauge completely from the reservoir to read the level in the transparent section.
- ☞ Top up if necessary.
- ☞ Refit the filler cap to the reservoir and close the bonnet.

Specification of the fluid

To ensure optimum cleaning and to avoid freezing, the fluid should never be topped up or replaced by plain water.

Diesel additive level (Diesel engine with particle emission filter)

SERVICE

A low additive level is indicated by illumination of the service warning lamp, accompanied by an audible warning and a message in the instrument panel screen.

Topping up

This additive must be topped up by a CITROËN dealer or a qualified workshop without delay.

Checks

Used products

 Avoid prolonged contact of used oil or fluids with the skin. Most of these fluids are harmful to health or indeed very corrosive.

 Do not discard used oil or fluids into sewers or onto the ground. Take used oil to a CITROËN dealer or a qualified workshop (France) or to an authorised waste disposal site.

Unless otherwise indicated, check these components in accordance with the servicing and warranty booklet and according to your engine. Otherwise, have them checked by a CITROËN dealer or a qualified workshop.

 Before doing anything under the bonnet, switch off the ignition (**Ready** lamp off) to avoid any risk of injury resulting from automatic operation of the engine.

12 V battery



The battery does not require any maintenance. However, check that the terminals are clean and correctly tightened, particularly in summer and winter.

When carrying out work on the battery, refer to the "12 V battery" section for details of the precautions to be taken before disconnecting the battery and following its reconnection.

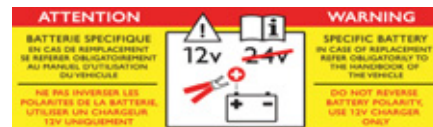

The presence of this label, in particular with the Stop & Start system, indicates the use of a specific 12 V lead-acid battery with special technology and specification. The involvement of a CITROËN dealer or a qualified workshop is essential when replacing or disconnecting the battery.

Air filter and passenger compartment filter



Refer to the servicing and warranty booklet for details of the replacement intervals for these components.

Depending on the environment (e.g. dusty atmosphere) and the use of the vehicle (e.g. city driving), **replace them twice as often if necessary.**

A clogged passenger compartment filter may have an adverse effect on the performance of the air conditioning system and generate undesirable odours.

Oil filter



Replace the oil filter each time the engine oil is changed.

Refer to the servicing and warranty booklet for details of the replacement interval for this component.

Particle emission filter (Diesel)

SERVICE

The start of saturation of the particle filter is indicated by the temporary illumination of this warning lamp accompanied by a message in the multi-function screen.

 The 100% electric mode is not available during regeneration of the particle emissions filter.

 As soon as the traffic conditions permit, regenerate the filter by driving at a speed of at least 40 mph (60 km/h) until the warning lamp goes off. If the warning lamp stays on, this indicates a low additive level.

On a new vehicle, the first particle filter regeneration operations may be accompanied by a "burning" smell, which is perfectly normal. Following prolonged operation of the vehicle at very low speed or at idle, you may, in exceptional circumstances, notice the emission of water vapour at the exhaust on acceleration. This does not affect the behaviour of the vehicle or the environment.



6-speed electronic gearbox



The gearbox does not require any maintenance (no oil change). Refer to the servicing and warranty booklet for details of the checking interval for this component.

Brake pads



Brake wear depends on the style of driving, particularly in the case of vehicles used in town, over short distances. It may be necessary to

have the condition of the brakes checked, even between vehicle services.

Unless there is a leak in the circuit, a drop in the brake fluid level indicates that the brake pads are worn.

Brake disc wear



For information on checking brake disc wear, contact a CITROËN dealer or a qualified workshop.

Electric parking brake



This system does not require any routine servicing. However, in the event of a problem, have the system checked by a CITROËN dealer or a qualified workshop.

For more information, refer to the "Electric parking brake - Operating faults" section.



Only use products recommended by CITROËN or products of equivalent quality and specification.

In order to optimise the operation of units as important as the braking system, CITROËN selects and offers very specific products.

After washing the vehicle, dampness, or in wintry conditions, ice, can form on the brake discs and pads: braking efficiency may be reduced. Make light brake applications to dry and defrost the brakes.

010
Technical data

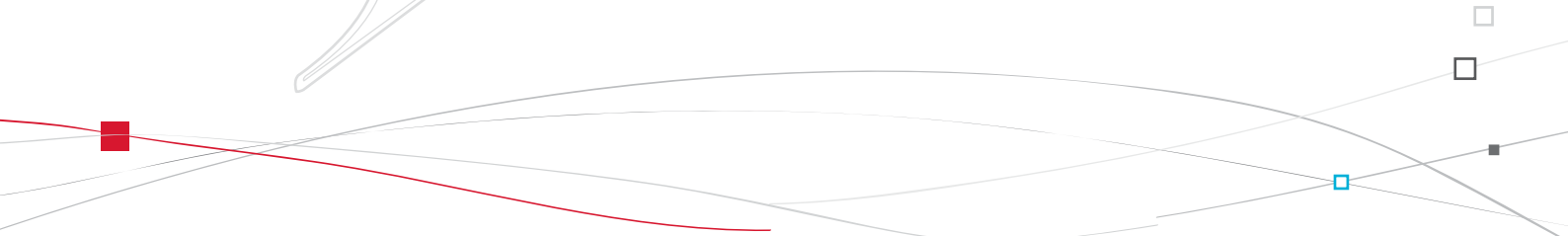



CITROËN

Electric motor and battery

Electric motor	-
Technology	Synchronous with permanent magnets.
Max. power: EU standard (kW)*	27
Max. power speed (rpm)	2 500
Max. torque: EU standard (Nm)	200
Max. torque speed (rpm)	1 250
Efficiency (%)	80 to 90
High voltage battery	Ni-MH (Nickel Metal Hydride)
Voltage (V~)	200
Energy capacity (kWh / Ah)	1.1 / 5.5
Range (miles (km))	1.2 (2) (approximately)

Range varies according to the ambient climatic conditions, the driving style and conditions, the use of vehicle systems and ageing of the battery.

* The maximum power corresponds to the value type approved on an engine test bed, under conditions defined by European legislation (directive 1999/99/EC).



Engine and gearbox

Diesel engine	HDi 160 PEF
Gearbox	Electronic gearbox system (6-speed)
Model code	RHC
Cubic capacity (cc)	1 997
Bore x stroke (mm)	85 x 88
Max power: EU standard (kW)*	120
Max power engine speed (rpm)	3 850
Max torque: EU standard (Nm)	300
Max torque engine speed (rpm)	1 750
Fuel	Diesel
Catalytic converter	yes
Particle emission filter	yes
Oil capacities (in litres)	
Engine (with filter replacement)	-

* The maximum power corresponds to the type approved value on a test bed, under conditions defined by European legislation (directive 1999/99/EC).

Weights and towed loads (in kg)

Diesel engine	HDi 160 PEF
Gearbox	Electronic gearbox system (6-speed)
Model code	RHC
- Unladen weight	-
- Kerb weight*	1 735
- Gross vehicle weight (GVW)	2 265
- Gross train weight (GTW) on a 12% gradient	2 765
- Braked trailer (within GTW limit) on a 10% or 12% gradient	500
- Braked trailer** (with load transfer with the GTW limit)	800
- Unbraked trailer	500
- Recommended nose weight	75

* The kerb weight is equal to the unladen weight + driver (75 kg).

** The weight of the braked trailer can be increased, within the GTW limit, if the GVW of the towing vehicle is reduced by an equal amount; warning, towing using a lightly loaded towing vehicle may have an adverse effect on its road holding.

To make use of the 300 kg load transfer, the driver must be alone in the vehicle with no luggage in the vehicle.

The GTW and towed load values indicated are valid up to a maximum altitude of 1 000 metres; the towed load mentioned must be reduced by 10 % for each additional 1 000 metres of altitude.

The speed of a towing vehicle must not exceed 60 mph (100 km/h) (comply with the legislation in force in your country).

High ambient temperatures may result in a reduction in the performance of the vehicle to protect the engine; if the ambient temperature is above 37 °C, limit the towed load.



Dimensions (in mm)

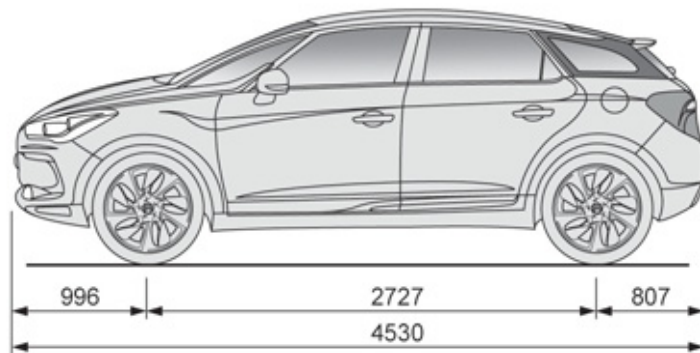
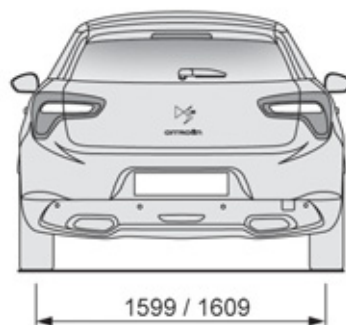
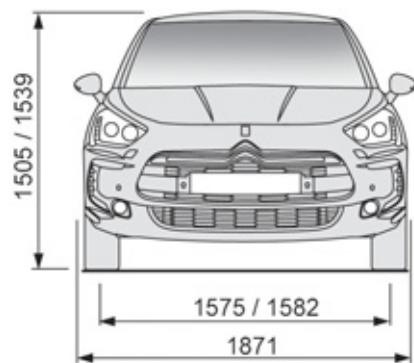

Identification markings

Various visible markings for the identification of your vehicle.

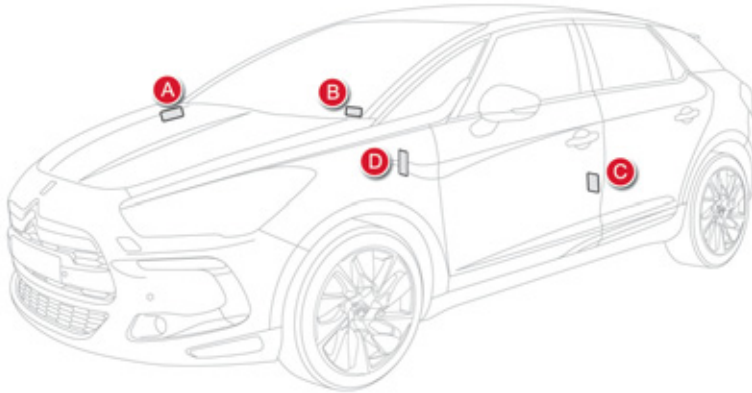

A. Vehicle Identification Number (VIN) under the bonnet.
This number is engraved on the bodywork near the damper support.

B. Vehicle identification Number (VIN) on the windscreen lower cross member.
This number is indicated on a self-adhesive label which is visible through the windscreen.

C. Manufacturer's label.
The VIN is indicated on a self-destroying label affixed to the door aperture, on the passenger's side.

D. Tyre/paint label.
This label is affixed to the centre pillar, on the driver's side.

It bears the following information:

- the tyre inflation pressures with and without load,
- the tyre sizes,
- the brands of tyre recommended by the manufacturer,
- the inflation pressure of the spare wheel,
- the paint colour code.

i The tyre pressures must be checked when the tyres are cold, at least once a month.
The rear quarter light cannot be etched as it is made of polycarbonate material.

! The use of snow chains is only authorised on the front wheels.
The selector must be in 4WD mode.

! If the tyre pressures are too low, this increases fuel consumption.



011

Audio and telematics

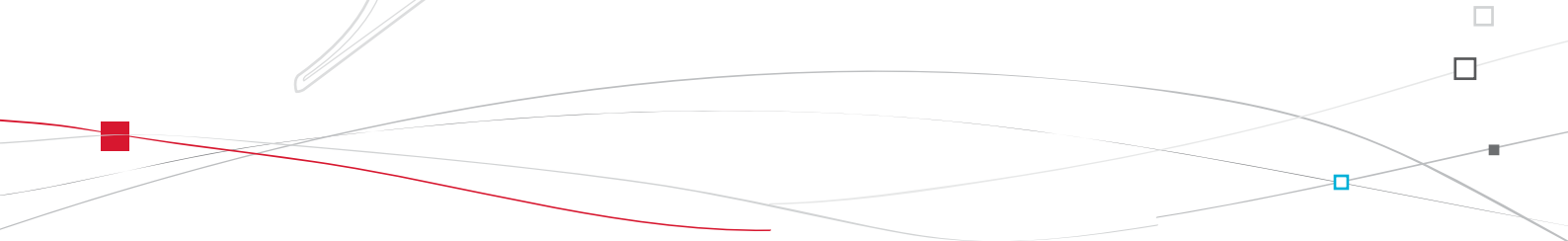



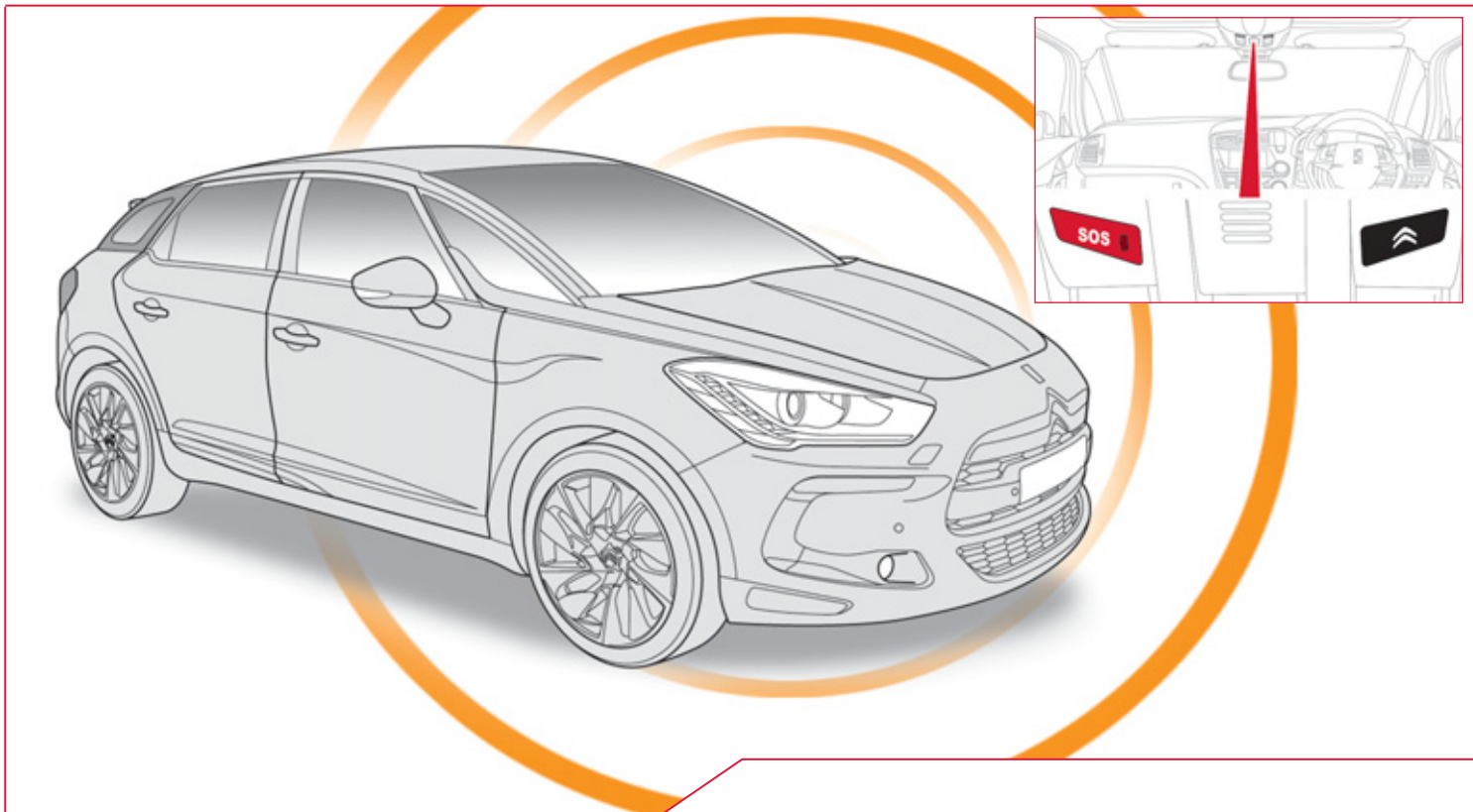

EMERGENCY OR ASSISTANCE CALL

EMERGENCY OR ASSISTANCE CALL

CITROËN LOCALISED EMERGENCY CALL



In an emergency, press this button for more than 2 seconds. Flashing of the green LED and a voice message confirm that the call has been made to the CITROËN Emergency service*.

Pressing this button again immediately cancels the call. The green LED goes off.
Pressing this button (at any time) for more than 8 seconds cancels the call.

The green LED remains on (without flashing) when communication is established. It goes off at the end of communication.

This call is dealt with by the CITROËN Emergency team which receives locating information from the vehicle and can send a detailed alert to the appropriate emergency services. In countries in which the team is not operational, or when the locating service has been expressly declined, the call is dealt with directly by the emergency services (112) without the vehicle location.



If an impact is detected by the airbag control unit, and independently of the deployment of any airbags, an emergency call is made automatically.

If you benefit from the CITROËN eTouch offer, you also have available additional services in your MyCITROËN personal space, via the CITROËN Internet website in your country, accessible on www.citroen.com.

* These services are subject to conditions and availability.
Consult a CITROËN dealer.

CITROËN LOCALISED ASSISTANCE CALL



Press this button for more than 2 seconds to request assistance if the vehicle breaks down.
A voice message confirms that the call has been made*.

Pressing this button again immediately cancels the request.
The cancellation is confirmed by a voice message.

OPERATION OF THE SYSTEM



When the ignition is switched on, the green LED comes on for 3 seconds indicating that the system is operating correctly.



If the orange LED flashes: there is a system fault.
If the orange LED is on continuously: the backup battery must be replaced.
In either case, contact a CITROËN dealer.

If you purchased your vehicle outside the CITROËN dealer network, we invite you to have a dealer check the configuration of these services and, if desired, modified to suit your wishes. In a multi-lingual country, configuration is possible in the official national language of your choice.

For technical reasons, particularly to improve the quality of Telematic services to customers, the manufacturer reserves the right to carry out updates to the vehicle's on-board telematic system.

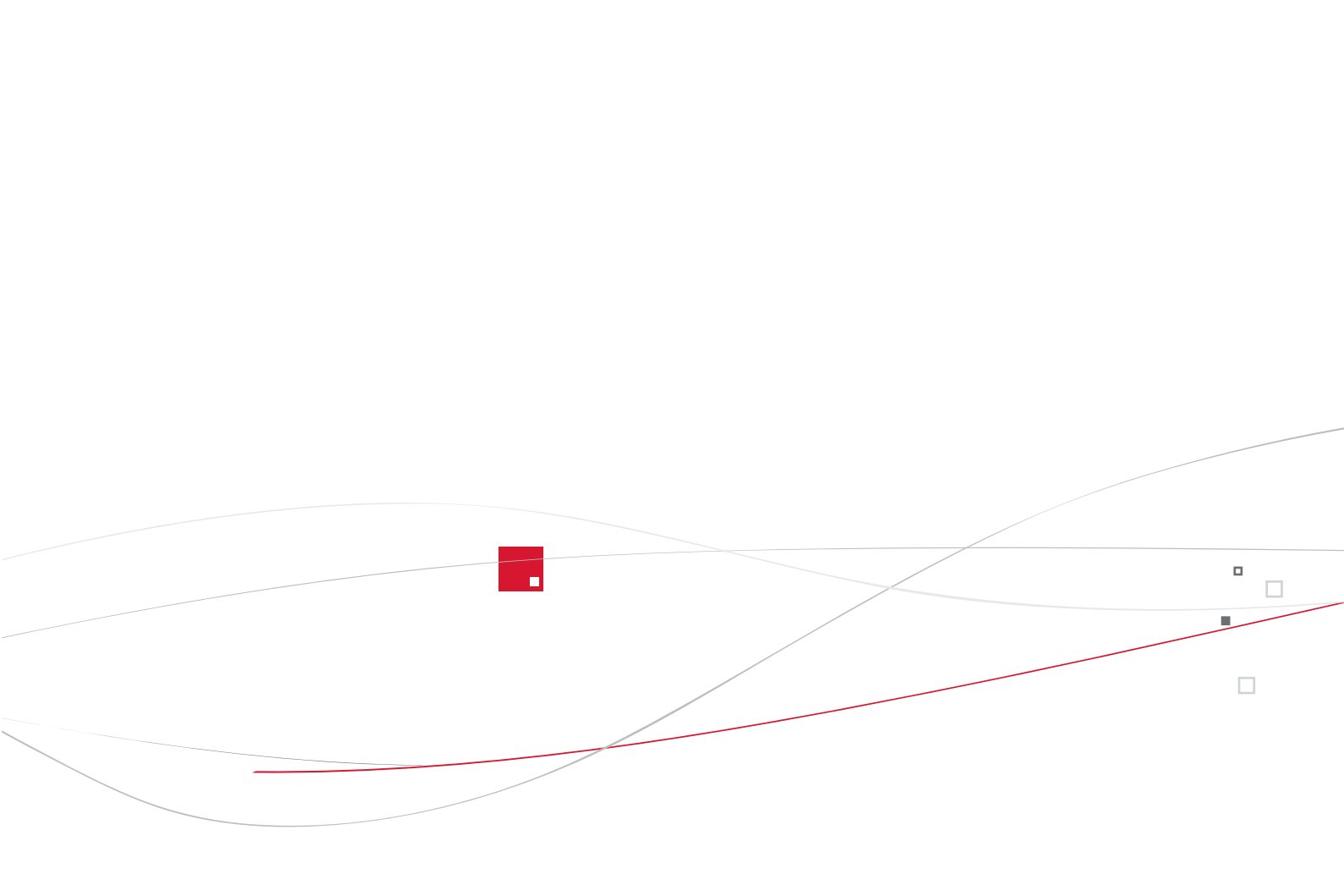

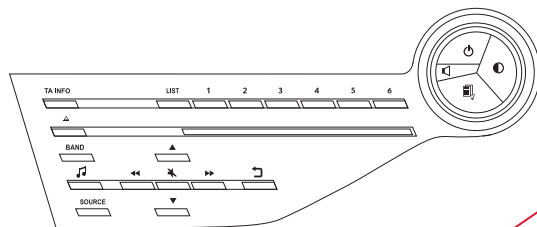

eMyWay

SATELLITE NAVIGATION SYSTEM MULTIMEDIA BLUETOOTH TELEPHONE AUDIO SYSTEM

CONTENTS

01 First steps - Control panel	p.	262
02 Steering mounted controls	p.	264
03 General operation	p.	265
04 Navigation - Guidance	p.	267
05 Traffic information	p.	280
06 Using the telephone	p.	283
07 Contacts - ADDR BOOK	p.	291
08 Radio	p.	294
09 Music media players	p.	297
10 Audio settings	p.	303
11 Configuration	p.	304
12 Screen menu map	p.	306
Frequently asked questions	p.	309



The system is protected in such a way that it will only operate in your vehicle.



For safety reasons, the driver must carry out operations which require prolonged attention while the vehicle is stationary.

When the engine is switched off and to prevent discharging of the battery, the system switches off following the activation of the energy economy mode.

01 FIRST STEPS

TA (Traffic Announcement) function On / Off.

Press and hold: reinitialise the system.

Select the FM waveband (AM not available on Hybrid vehicles).

Access to **"Audio settings"**: musical ambiances, bass, treble, loudness, distribution, left/right balance, front/rear fader, automatic volume adjustment.

Select the source: CD, USB, AUX, Apple® player, Bluetooth Streaming, Radio.

Select:

- the previous/next line in a list or menu.
- the previous next media folder.
- step by step previous/next radio frequency.
- previous/next MP3 folder.

Move up/down, in **"Move the map"** mode.

Display the list of radio stations received, CD/MP3/Apple® player tracks or folders.

Long press: management of the classification of MP3/WMA files/update the list of stations received.

Short press: select a preset radio station.

Long press: store the current radio station.

Rotation: adjust volume (each source is independent, including TA messages and navigation instructions).

On / Off.

Display black screen.

MODE button: select the type of permanent display.

Abandon the current operation, go up one level.

Long press: return to permanent display.

Short press: mute / restore sound.

Select:

- automatically the previous/next radio frequency.
- the previous/next CD, MP3 or media track.

Move left/right, in **"Move the map"** mode.

01 FIRST STEPS

Access to the **"Telephone"** menu and display the list of recent calls or accept an incoming call.

Access to the **"Navigation - guidance"** menu and display the recent destinations.

Radio source, access to the **"RADIO"** menu and display the list of stations received.

Access to the **"Configuration"** menu.

Long press: access to the GPS coverage and navigation demonstration mode.

Abandon the current operation, go up one level.
Long press: return to permanent display.

Reject an incoming call or end a call in progress.

Access to the **"Traffic information"** menu and display of current traffic alerts.

Media source, access to **"MEDIA"** menu and display the list of tracks.

Display the list of contacts / Access to the **"Directory of contacts"** menu.

Selection and OK confirmation dial:
Select an item on the screen or in a list or a menu, then confirm with a short press.
Other than for menus and lists, a short press calls up a contextual memory, according to the display in the screen.
Rotation with the map displayed: zoom in/out in the map.



02 STEERING MOUNTED CONTROLS

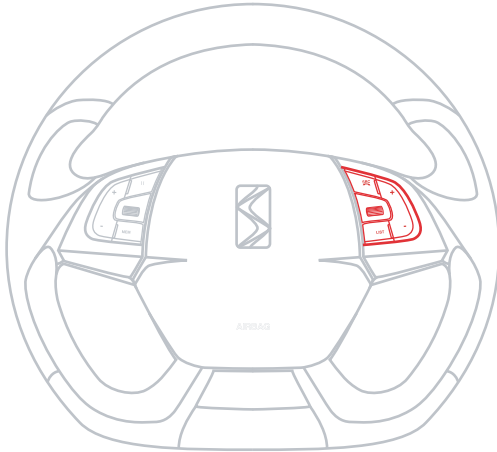

- Rotation
Radio -automatic selection of next / previous frequency.
Media: previous / next track.
- Press then rotation: access to 6 preset stations.



- Change the audio source.
- TEL button (short press):
Accept an incoming call
Call in progress: access to telephone menu: hang up, secret mode, hands-free mode.
- TEL button (long press):
Reject an incoming call or end a call in progress.
When not making a call, access to the telephone menu (Dial, Contacts, Calls log, Voice mailbox).



- Increase volume.
- Decrease volume.



- Radio: display the list of stations.
Media: display the list of tracks.

03 GENERAL OPERATION



Press the **MODE** button several times in succession for access to the following displays:

"RADIO"

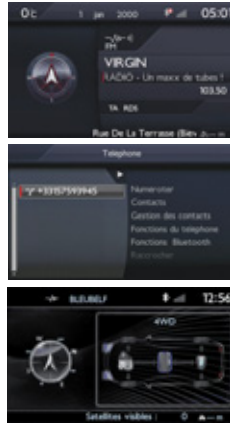

"TELEPHONE"

(If conversation in progress)

HYBRID FLOW

For more information, refer to the "Hybrid System" section, then "View hybrid flow information".

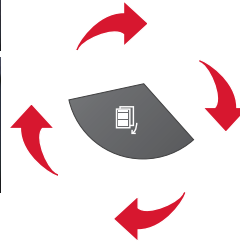

"FULL SCREEN MAP"

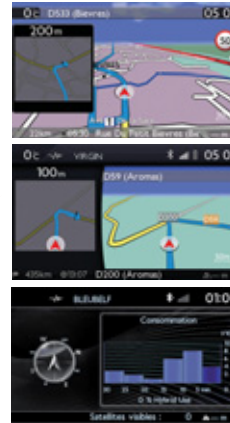

"MAP IN WINDOW"

(If navigation guidance in progress)

HYBRID CONSUMPTION

For more information, refer to the "Hybrid System" section, then "Consumption of your hybrid".



SETUP: PARAMETERS

date and time, display configuration, sound, vehicle settings.

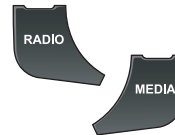

Changing the audio source:

RADIO: RADIO broadcasts.

MUSIC: playing MUSIC.



For cleaning the screen, the use of a soft, non-abrasive cloth (spectacles cloth) is recommended, with no additional product.



For the details of the menus, refer to the "Screen menu map" section.

03 GENERAL OPERATION

DISPLAY ACCORDING TO CONTEXT



A press on the dial gives access to short-cut menus according to the display in the screen.

RADIO:

- 1 Activate / Deactivate TA
- 1 Activate / Deactivate RDS
- 1 Change waveband
- 1 TA

TELEPHONE (call in progress):

- 1 Private mode
- 1 Put call on hold

1 DTMF ring tones

1 Hang up

MUSIC MEDIA PLAYERS, CD or USB (according to media):

Play modes:

- 1 Normal
- 1 Random
- 1 Random on all media
- 1 Repetition

FULL SCREEN MAP OR IN A NEW WINDOW:

- 1 Stop / Restore guidance

1 Select destination

2 Enter an address

2 Directory

2 GPS coordinates

1 Divert route

1 Move the map

2 Info. on location

2 Select as destination

2 Select as stage

2 Save this place (contacts)

2 Quit map mode

1 Guidance criteria

04 NAVIGATION - GUIDANCE

Access to the "NAVIGATION" menu



Press **NAV**.

A short press on the end of the lighting control stalk repeats the last navigation message.



To make full use of all of the functions of your navigation system, update the mapping regularly. Contact a CITROËN dealer or order your mapping update at <http://citroen.navigation.com>

To delete the list of recent destinations, select "**Guidance options**" in the navigation menu then select "**Delete last destinations**" and confirm. Select "**Yes**" then confirm. Deleting just one destination is not possible.

Go from the list to the menu (left/right).















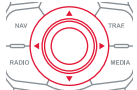

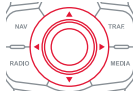

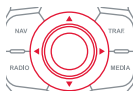
or

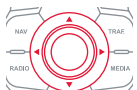

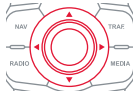
04 NAVIGATION - GUIDANCE

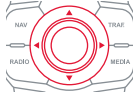

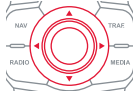
SELECTING A DESTINATION

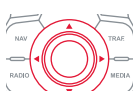
TOWARDS A NEW DESTINATION



<p>1</p>  <p>Press NAV to display the "Navigation - guidance" menu.</p>	
<p>2</p>  <p>Select "Select destination" and confirm, then select "Enter an address" and confirm.</p>	
<p>3</p>  <p>Select the "Country" function then confirm.</p>	
<p>4</p>  <p>Select the "Town" or "Post code" function then confirm.</p>	
<p>5</p>  <p>Select the letters in the name of the town or the characters in a post code one at a time, confirming each one with the knob.</p>	
<p>6</p>  <p>Selection the town from the list offered, then confirm. A pre-set list (by entering the first few letters) of the towns in the country selected can be accessed directly by selecting and confirming "List" in the screen.</p>	
<p>7</p>  <p>If possible, enter the "Road" and "N°/X" information in the same way.</p>	
 <p>Select "Archive" to save the address entered in a contact file. The system allows up to 400 contact files to be recorded.</p>	
<p>8</p>  <p>Confirm "OK" to start guidance.</p>	
<p>9</p>  <p>Select the guidance criteria: "Fastest route", "Shortest route" or optimised "Distance/Time", then select the desired restriction criteria: "With tolls", "With Ferry", or "Traffic info" then confirm "OK".</p>	

04 NAVIGATION - GUIDANCE

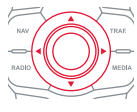

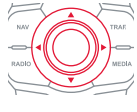

TOWARDS ONE OF THE RECENT DESTINATIONS

<p>1</p> 	<p>Press NAV to display the "Navigation - guidance" menu.</p> 
<p>2</p> 	<p>Select the desired destination and confirm to start guidance.</p> 

DELETE RECENT DESTINATIONS

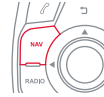

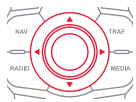

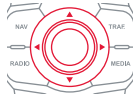
<p>1</p> 	<p>Press NAV to display the "Navigation - guidance" menu.</p> 
<p>2</p> 	<p>Select "Options" and confirm and then "Delete recent destinations" and confirm.</p> 

TOWARDS A CONTACT IN THE CONTACTS DIRECTORY



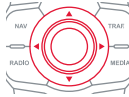

<p>i</p> <p>Navigation towards a contact is only possible if it has an address entered in the audio navigation system.</p>	
<p>1</p> 	<p>Press NAV to display the "Navigation - guidance" menu.</p> 
<p>2</p> 	<p>Select "Select destination" and confirm, then select "Directory" and confirm.</p> 
<p>3</p> 	<p>Selection the desired destination from your contacts and confirm "OK" to start the guidance.</p> 

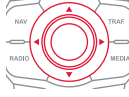
04 NAVIGATION - GUIDANCE

TOWARDS GPS COORDINATES

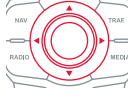
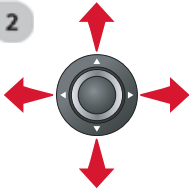
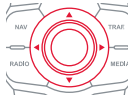
1	 <p>Press NAV to display the "Navigation - guidance" menu.</p>	
2	 <p>Select "Select destination" and confirm, then select "GPS coordinates" and confirm.</p>	
3	 <p>Enter the GPS coordinates and confirm "OK" to start the guidance.</p>	

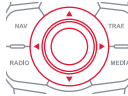
TOWARDS A POINT ON THE MAP

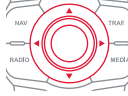
1	 <p>With the map displayed, press OK to display the contextual menu. Select "Move the map" and confirm.</p>	
2	 <p>Move the cursor using the control to identify the desired destination.</p>	
3	 <p>Press OK to display the contextual menu for "Move the map" mode.</p>	
4	 <p>Select "Select as destination" or "Select as stage" and confirm.</p>	

04 NAVIGATION - GUIDANCE

TOWARDS POINTS OF INTEREST (POI)

The points of interest (POI) indicate all of the service locations in the vicinity (hotels, various businesses, airports...).

1



Press **NAV** to display the "**Navigation - guidance**" menu.



2



Select the "**Enter an address**" function and confirm, then select **Select destination** and confirm.

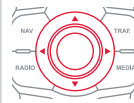

3



To select a POI close to your current location, select "**POI**" and confirm, then select "**Around the current place**" and confirm.

To select a POI as a stage on the route, select "**POI**" and confirm, then select "**On the route**" and confirm.

To select a POI as a destination, first enter the country and town (see "Towards a new destination"), select "**POI**" and confirm, finally select "**Near**" and confirm.

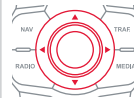

Select "**Search by Name**" to search for POIs by name and not by proximity.

4



Search for POIs in the categories suggested in the following pages.

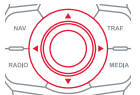

5



Select the POI and confirm "**OK**" to start the guidance.

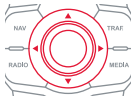















04 NAVIGATION - GUIDANCE











This icon appears when several POIs are grouped together in the same area. Zooming in on this icon shows details of the POIs.



LIST OF PRINCIPAL POINTS OF INTEREST (POI)

-  Service station
-  Garage
-  CITROËN
-  Covered car park
-  Car park
-  Rest area
-  Hotel
-  Restaurant
-  Cafeteria
-  Bed and breakfast

-  Airport
-  Railway station
-  Bus station
-  Port
-  Industrial estate
-  Supermarket
-  Vending machine
-  Sports complex, sports centre, sports ground
-  Swimming pool
-  Winter sports resort

-  Cinema
-  Theme parks
-  Hospital, Chemist, Vet
-  Police station
-  School
-  Town hall
-  Post office
-  Museum, Culture, Theatre, Historic monument
-  Tourist information, Tourist attraction
-  Risk areas / Danger areas*



An annual mapping update allows new points of interest to be presented to you. You can also update the Risk areas / Danger areas every month. The detailed procedure is available on <http://citroen.navigation.com>.

* According to availability in the country.

04 NAVIGATION - GUIDANCE

ALERT PARAMETERS RISK AREAS / DANGER AREAS

1



Press **NAV** to display the "**Navigation - guidance**" menu.



These functions are only available if risk areas have been downloaded and installed on the system.
The detailed procedure for updating risk area POIs can be found at <http://citroen.navigation.com>.

2



Select "**Guidance options**" and confirm, then select "**Set parameters for risk areas**" and confirm.

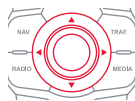

3



Select:

- "Visual alert"
- "Audible alert"
- "Alert only in guidance"
- "Overspeed alarm only".





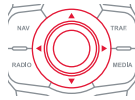

The choice of time of notification defines how long in advance that Risk area warnings are given.

Select "**OK**" to confirm the screen.



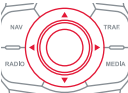

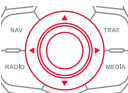

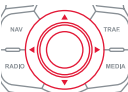

04 NAVIGATION - GUIDANCE

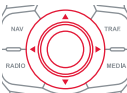
ADDING A STAGE

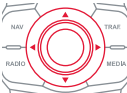
<p>1</p> 	<p>Press NAV to display the "Navigation - guidance" menu.</p>	
<p>2</p> 	<p>Select "Journey leg and route" then confirm.</p>	
<p>3</p> 	<p>Select "Add a stage" then confirm. The address of the stage is entered as a destination, by "Enter an address", a contact in "Directory", or "Previous destinations".</p>	
<p>4</p> 	<p>Select "Close to" a route passing close to the stage or "Strict" for a route passing through the stage. Confirm "OK" to start the guidance, and give a general indication of the guidance route.</p>	

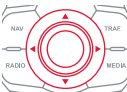
ORGANISING STAGES

<p>1</p> 	<p>To organise stages, carry out operations 1 to 2 again, then select "Order/delete journey legs" and confirm.</p>	
<p>2</p> 	<p>Select the stage that you want to move in the order.</p>	
<p>3</p> 	<p>Select and confirm to save the modifications.</p>	
<p> Select "Delete" to delete the stage.</p>		

04 NAVIGATION - GUIDANCE

ROUTE OPTIONS

CALCULATION CRITERIA

1



Press **NAV** to display the "Navigation - guidance" menu.



2



Select "**Guidance options**" and confirm.

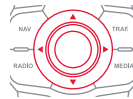

3



Select "**Define calculation criteria**" and confirm.

This function allows modification of:

- the guidance criteria: ("**Fastest route**", "**Shortest route**", "**Distance/Time**"),
- the exclusion criteria: ("**With tolls**" or "**With Ferry**"),
- traffic avoidance: ("**Traffic info**").

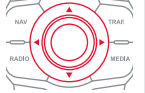

i

If traffic avoidance (Traffic info) is selected, the system suggests an alternative route if there is a delay on the guidance route.

4



Select "**OK**" and confirm to save the modifications.

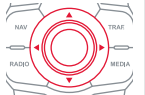

04 NAVIGATION - GUIDANCE

MAP MANAGEMENT

SELECTING THE POINTS OF INTEREST DISPLAYED ON THE MAP

1



Press **NAV** to display the "Navigation - guidance" menu.



2



Select "**Map management**" and confirm.

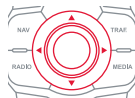

3



Select "**Map details**" and confirm.

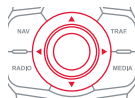

4



Select from the various categories the ones that you want to display on the screen.

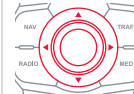

Select "**By default**" to have only "**Oil stations, garages**" and "**Accident-prone area**" appear on the map (if installed in the system).

5



Select "**OK**" then confirm and select "**OK**" again then confirm to save the modifications.

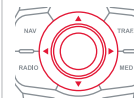

04 NAVIGATION - GUIDANCE

MAP ORIENTATION

1



Press **NAV** to display the "Navigation - guidance" menu.



4



Select:

- **"Vehicle direction"** to have the map follow the direction of travel,
- **"North direction"** to keep the map always North up,
- **"Perspective view"** to display a perspective view.

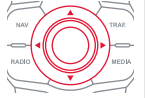

2



Select **"Map management"** and confirm.

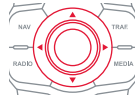

The colour of the map, different from the day and night mode, is configured in the **"SETUP"** menu.

3



Select **"Map orientation"** and confirm.

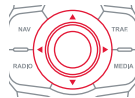











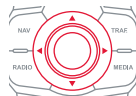

Street names are visible on the map from the 100 m scale.

04 NAVIGATION - GUIDANCE

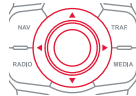
ADJUSTING THE GUIDANCE SPEECH SYNTHESIS

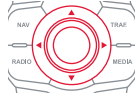
ADJUSTING THE VOLUME/DEACTIVATION

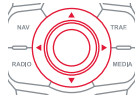
The volume setting of guidance messages is also accessible via the "SETUP" / "Voice synthesis" menu.

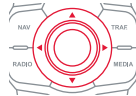
 <p>The volume of messages can be adjusted during the transmission of the message using the volume adjustment control.</p>	<p>4</p>  <p>Select the volume graph and confirm.</p> 
<p>1</p>  <p>Press NAV to display the "Navigation - guidance" menu.</p> 	<p>5</p>  <p>Adjust the volume to the desired level and confirm.</p> 
<p>2</p>  <p>Select "Guidance options" and confirm.</p> 	 <p>Select "Deactivate" to deactivate voice messages.</p>
<p>3</p>  <p>Select "Set speech synthesis" and confirm.</p> 	<p>6</p>  <p>Select "OK" and press the dial to confirm.</p> 

04 NAVIGATION - GUIDANCE

MALE VOICE / FEMALE VOICE

1



Press **SETUP** to display the configuration menu.



2



Select "**Voice synthesis**" and confirm.

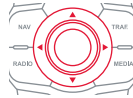

3



Select "**Select male voice**" or "**Select female voice**" then confirm "**Yes**" to activate a male or female voice. The system restarts.

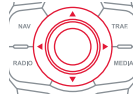

05 TRAFFIC INFORMATION

Access to the "TRAFFIC INFORMATION" menu



Press "TRAFFIC".

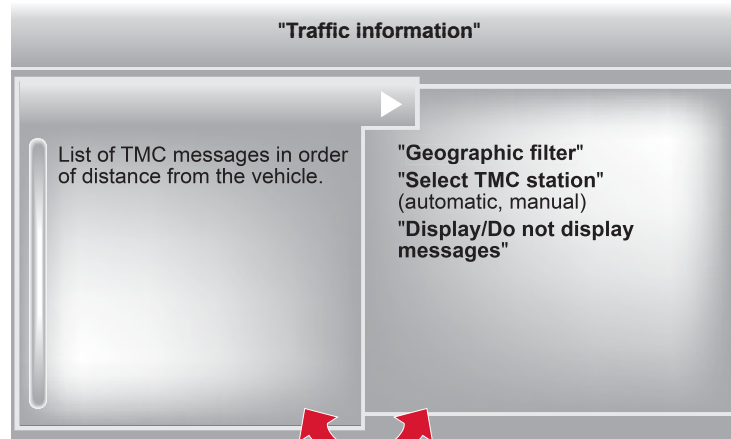

Go from the list to the menu (left/right).



or



05 TRAFFIC INFORMATION

CONFIGURE THE FILTERING AND DISPLAY OF TMC MESSAGES

TMC (Traffic Message Channel) messages contain information on traffic and weather conditions, received in real time and transmitted to the driver in the form of audible announcements and symbols on the navigation map.

The navigation system can then suggest an alternative route to avoid a traffic problem.

1



Press the **TRAFFIC** button to display the "Traffic information" menu.



2



Select the "**Geographic filter**" function and confirm.

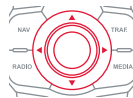

3



The system offers a choice of:

- **"Retain all the messages"**,
- or
- **"Retain the messages"**
 - **"Around the vehicle"**, (confirm the mileage to modify and select the distance),
 - **"On the route"**.

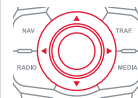

4



Confirm **"OK"** to save the modifications.

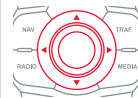

i

We recommend:

- a filter on the route and
- a filter around the vehicle of:
 - 12 miles (20 km) in urban areas,
 - 30 miles (50 km) on motorways.

05 TRAFFIC INFORMATION

PRINCIPAL TMC SYMBOLS

1 Black and blue triangle: general information, for example:



2 Red and yellow triangle: traffic information, for example:



RECEIVING TA MESSAGES

! The TA (Traffic Announcement) function gives priority to TA alert messages. To operate, this function needs good reception of a radio station transmitting this type of message. When a traffic report is transmitted, the current audio source (Radio, CD, USB, ...) is interrupted automatically to play the TA message. Normal playback of the audio source resumes at the end of the transmission of the message.

1  Press **RADIO** to display the menu.

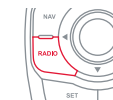

2  Select "**Guidance options**" then confirm.

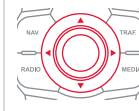

3  Activate or deactivate "**TA**" then confirm.

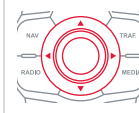

! The volume setting for TA messages can be adjusted only during the transmission of this type of alert.

 Activate or deactivate the function at any time by pressing the button.
During a message, press the button to interrupt it.

06 USING THE TELEPHONE

Access to the "TELEPHONE" menu



Press this button.

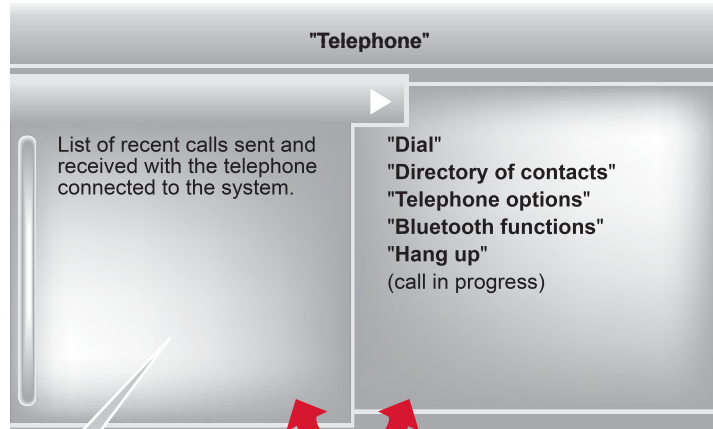

In the top bar of the permanent display



No telephone connected.



Telephone connected.



Incoming call.



Outgoing call.



Synchronisation of address book in progress.



Telephone call in progress.

To make a call, select a number in the list and confirm "OK" to start the call.



Connecting a different telephone deletes the list of recent calls.

Go from the list to the menu (left/right).



or



06 USING THE TELEPHONE

PAIRING A BLUETOOTH TELEPHONE FIRST CONNECTION



For reasons of safety and because they require prolonged attention on the part of the driver, the operations for pairing the Bluetooth mobile telephone to the hands-free system of the audio unit must be carried out with the **vehicle stationary**.



You can check the compatibility of your telephone at www.citroen.co.uk (services).

1

Activate the telephone's Bluetooth function and ensure that it is "visible to all" (telephone configuration).



2



Press this button.



3



Select "**Bluetooth functions**" and confirm.

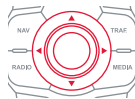

4



Select "**Peripherals search**" and confirm.

The list of peripherals detected is displayed. Wait until the "**Connect**" button is available.

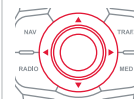

5



Select the name of the desired peripheral from the list of devices detected then select "**Connect**" and confirm.

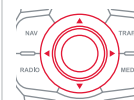

6



The system offers to connect the telephone:

- in "**Hands-free mode**" (telephone only),
- in "**Audio**" mode (streaming: playing music files on the telephone),
- or "**All**" (for selection of both modes).

Select "**OK**" and confirm.

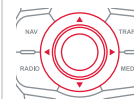

06 USING THE TELEPHONE



The services available depend on the network, the SIM card and the compatibility of the Bluetooth telephone used. Check the telephone manual and with your network provider for details of the services available to you.



The "**Hands-free mode**" should be used in preference if "Streaming" is not desired.



The ability of the system to connect in only one mode depends on the telephone. The two modes may both connect by default.

7



Select a code for the connection then confirm "**OK**".

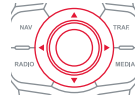

8

Enter the same code on the telephone then accept the connection.



Then accept automatic connection on the telephone to allow the telephone to reconnect automatically every time the vehicle is started.



Depending on the type of telephone, the system will ask you to accept or not the transfer of your contacts.



On return to the vehicle, the last telephone connected automatically reconnects, within around 30 seconds after switching on the ignition (Bluetooth activated and visible).
To modify the automatic connection mode, remove the pairing and pair the telephone again with the desired mode.

06 USING THE TELEPHONE

MAKING A CALL

Use of the telephone is not recommended while driving. We recommended that you park safely or make use of the steering mounted controls.

CALLING A NEW NUMBER

1



Press this button.



2



Select **"Dial"** then confirm.

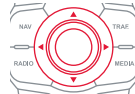

3



Dial the telephone number using the virtual keypad selecting each number in turn.
Confirm **"OK"** to make the call.

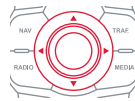

CALLING A CONTACT

1



Press this button or make long press on the steering mounted **TEL/SRC** button.

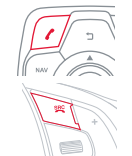

2



Select **"Directory of contacts"** then confirm.

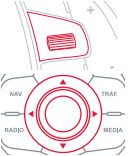

3



Select the desired contact and confirm.

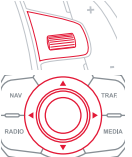

4



Select the number and confirm to start the call.

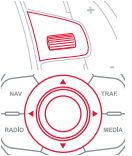

06 USING THE TELEPHONE

CALLING A RECENTLY DIALLED NUMBER

1



Press this button or make a long press on **TEL/SRC**, select "**Call list**" and confirm,



2



Select the desired number and confirm.

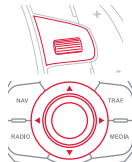

To erase the calls log, press **PHONE**, select "**Telephone options**" and confirm then select "**Delete calls log**" and confirm.

i

It is always possible to make a call directly from the telephone; park the vehicle first as a safety measure.

ENDING A CALL

1



Press **HANG UP**

or



Make a long press on the steering mounted **TEL/SRC** button.



06 USING THE TELEPHONE

RECEIVING A CALL

1

An incoming call is announced by a ring and a superimposed display in the screen.

2



"Yes" to accept the call is selected by default.
Press "**OK**" to accept the call.
Select "**No**" and confirm to reject the call.

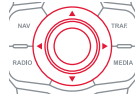

A long press on this button or **TEL/SRC** or a press on **HANG UP** rejects an incoming call.



A short press on this button or **TEL/SRC** accepts an incoming call.



06 USING THE TELEPHONE

OPTIONS DURING A CALL *

1



During a call, press the **MODE** button several times to select display of the telephone screen, then press "**OK**" to open the contextual menu.



Or make a short press on this button.

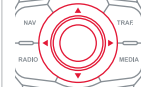
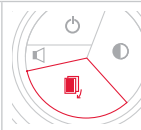

2c



Select "**DTMF ring tones**" to use the numerical keypad, so as to navigate through the menu of an interactive vocal server.

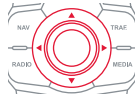

2d



Select "**Hang up**" to end the call.

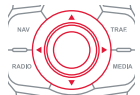

2a



Select "**Private mode**" and confirm to take the call on the handset.
Or select "**Hands-free mode**" and confirm to take the call via the vehicle's speakers.



2b



Select "**Put call on hold**" and confirm to put the current call on hold.
Or select "**Resume the call**" and confirm to resume the call on hold.







it is possible to hold a 3-way conference call by making 2 calls in succession*. Select "**Conference mode call**" in the contextual menu accessible using this button.







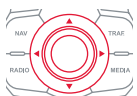

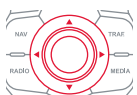

* Depending on the compatibility of the phone and your service plan.

06 USING THE TELEPHONE

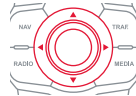
MANAGING PAIRED TELEPHONES

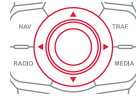
<p>1</p>  <p>Press this button.</p>	
<p>2</p>  <p>Select "Bluetooth functions".</p>	
<p>3</p>  <p>Select "List of the paired peripherals" and confirm.</p> <p>It is possible to:</p> <ul style="list-style-type: none">- "Connect" or "Disconnect" the selected telephone,- delete the pairing of the selected telephone. <p>It is also possible to select all pairings.</p>	

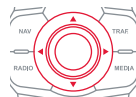
CHANGING THE RING TONE

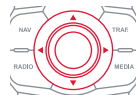
<p>1</p>  <p>Press this button.</p>	
<p>2</p>  <p>Select "Telephone options" and confirm.</p>	
<p>3</p>  <p>Select "Ring options" and confirm.</p>	
<p>4</p>  <p>You can adjust the volume and the ring tone used.</p>	
<p>5</p>  <p>Select "OK" and confirm to save the changes.</p>	

07 DIRECTORY - ADDR BOOK

Access to the "CONTACTS" menu



Press ADDR BOOK.



The sorting of the list of contacts depends on the telephone used.

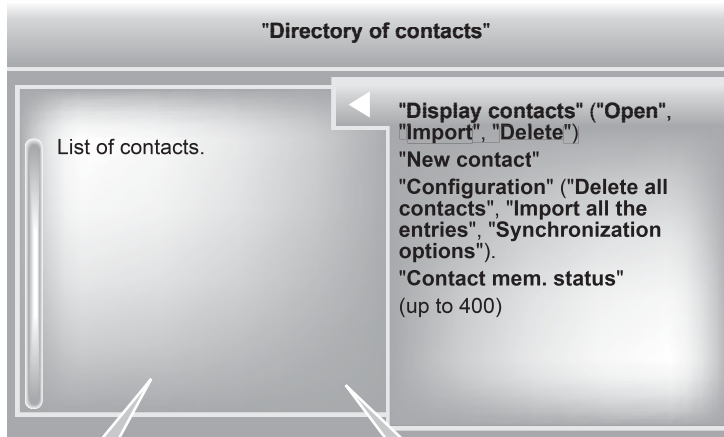

Destination:

- from the contacts in the mobile telephone and the SIM card (depending on the synchronization options in the Bluetooth menu and the compatibility of the telephone),
- saved in the system.

Select a contact and confirm.

Then select **"Guide"** and confirm.



Telephone contacts:

- from the mobile telephone and the SIM card (depending on the synchronization options in the Bluetooth menu and the compatibility of the telephone),
- saved in the system.

Select a telephone contact and confirm to start the call.

07 DIRECTORY - ADDR BOOK

ENTERING A NEW CONTACT / SYNCHRONIZING WITH THE TELEPHONE

1



Press **ADDR BOOK** twice then select **"New contact"** to enter a new contact.



2



Press **ADDR BOOK** twice then select **"Configuration"** and confirm.



3a



Select **"Delete all contacts"** to delete the contacts saved in the system.

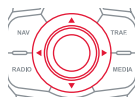

3b



Select **"Import all the entries"** to import all the contacts in the telephone and save them in the system.

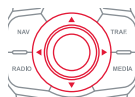

3c



Select **"Synchronization options"** and confirm:

- No synchronization: only the contacts saved in the system (always present).
- Display telephone contacts: only the contacts saved in the telephone.
- Display SIM card contacts: only the contacts saved on the SIM card.
- Display all phone contacts: contacts on the SIM card and in the telephone.

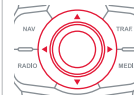

4











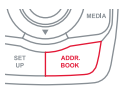

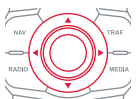

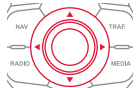
Press **ADDR BOOK** twice then select **"Contact mem. status"** to see the number of contacts saved in the system or imported, and the free memory.

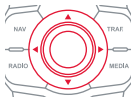

07 DIRECTORY - ADDR BOOK

EDITING, IMPORTING OR DELETING A CONTACT

<p>1</p> 	<p>Press ADDR BOOK twice then select "Display contacts" and confirm.</p>		<p>3b</p>  <p>Select "Import" to copy the contacts to the system.</p>	
<p>2</p> 	<p>Select the desired contact and confirm.</p>		<p>i</p> <p>In this "Display contacts" menu, the import or deletion of contacts in the system is done one at a time.</p>	
<p>3a</p> 	<p>Select "Open" to view an external contact or modify a contact saved in the system.</p>		<p>3c</p>  <p>Select "Delete" and confirm.</p>	
<p>i</p> <p>It is necessary to import an external contact to modify the record. It will be saved in the system. It is not possible to modify or delete contacts in the telephone or the SIM card via the Bluetooth connection.</p>			<p>4</p>   <p>Select OK or press this button to exit this menu.</p>	 

08 RADIO

Access to the "RADIO" menu



Press **RADIO**.



A long press on **LIST** refreshes the list of stations received.

"FM waveband"

Alphabetical list of stations received.



"Change waveband" ("FM waveband")

"Options" ("TA, RDS, AF")

"Audio settings" (see this section)

"Update radio list"



Press **▲** or **▼** or use the rotary control to select the previous or next station in the list.



This list can also be displayed by pressing **LIST** on the steering mounted controls.

Go from the list to the menu (left/right).



or



08 RADIO

SELECTING A STATION



The external environment (hill, building, tunnel, underground car park...) may interfere with the reception, including in RDS station tracking mode. This phenomenon is a normal result of the way in which radio waves are transmitted and does not in any way indicate a fault with the audio system.



The quality of reception is represented by the number of active waves in this symbol.

1a



By alphabetical list

Press **RADIO** or **LIST**, select the station of your choice and confirm.

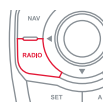

1b

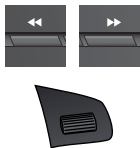

By automatic frequency search

Press **◀** or **▶** for the automatic search for a lower or higher radio frequency. Or turn the thumb wheel at the steering mounted controls.



1c



By manual frequency search

Press **▲** or **▼** to adjust the radio frequency step by step.

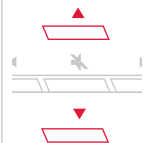

PRESETTING A STATION

1



After selecting a station, press one of the buttons on the numerical keypad for 2 seconds to preset the current station. An audible signal confirms that the station has been preset.



2



Press the button on the numerical keypad to recall a preset station. Or press then turn the thumb wheel at the steering mounted controls.

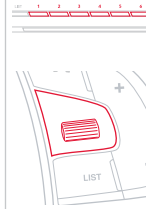

08 RADIO

ACTIVATE / DEACTIVATE RDS



RDS, if activated, allows you to continue listening to the same station by automatic retuning to alternative frequencies. However, in certain conditions, coverage of an RDS station may not be assured throughout the entire country as radio stations do not cover 100 % of the territory. This explains the loss of reception of the station during a journey.

1



Press **RADIO**.

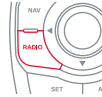

2



Select "**Guidance options**" then confirm.

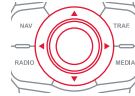

3



Activate or deactivate "**RDS**" then confirm.

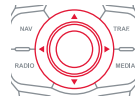

09 MUSIC MEDIA PLAYERS

Access to the "MUSIC MEDIA PLAYER" menu



Press **MEDIA**.

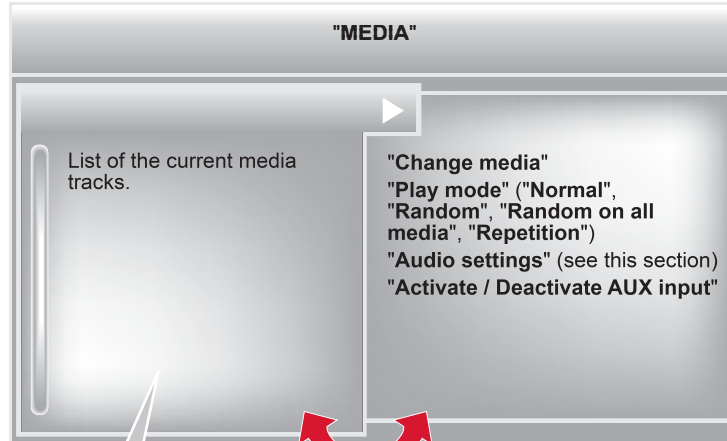

List of the current media tracks.

"Change media"

"Play mode" ("Normal", "Random", "Random on all media", "Repetition")

"Audio settings" (see this section)

"Activate / Deactivate AUX input"

This list can also be displayed by pressing **LIST** at the steering mounted controls.



Go from the list to the menu (left/right).



or



09 MUSIC MEDIA PLAYERS

CD, MP3 CD / USB PLAYER

INFORMATION AND ADVICE



The audio equipment will only play audio files with ".wma, .aac, .flac, .ogg and .mp3" file extensions and with a bit rate of between 32 Kbps and 320 Kbps.

It also supports VBR (Variable Bit Rate) mode.

No other type of file (.mp4, .m3u...) can be played.

WMA files must be of the standard wma 9 type.

The sampling rates supported are 11, 22, 44 and 48 KHz.



It is advisable to restrict file names to 20 characters, without using of special characters (e.g.: " " ? ; ù) to avoid any playing and displaying problems.



In order to be able to play a recorded CDR or CDRW, when recording it is preferable to select the ISO 9660 level 1, 2 or Joliet standard.

If the disc is recorded in another format it may not be played correctly.

It is recommended that the same recording standard is always used for an individual disc, with as low a speed as possible (4x maximum) for optimum sound quality.

In the particular case of a multi-session CD, the Joliet standard is recommended.



The system supports USB mass storage or iPod devices via the USB port (suitable cable not supplied).

If a partitioned USB memory key is connected to the system, only the first partition is recognised.

Control of the peripheral device is with the audio system controls.

The number of tracks is limited to 2000 maximum, 999 tracks per folder.

If the current consumption at the USB port exceeds 500 mA, the system goes into protection mode and deactivates the port.

Other peripherals, not recognised on connection, must be connected to the auxiliary socket using a Jack cable (not supplied).



In order to be read, a USB memory stick must be formatted FAT 16 or 32.



The system does not support the operation of an Apple® player and a USB memory stick connected at the same time.



It is recommended that official Apple® USB cables are used to ensure correct operation.

09 MUSIC MEDIA PLAYERS

SOURCES



Insert the CD in the player, insert the USB memory stick in the USB player or connect the USB peripheral to the USB port using a suitable cable (not supplied).

The system builds playlists (in temporary memory), an operation which can take from a few seconds to several minutes at the first connection.

Reduce the number of non-music files and the number of folders to reduce the waiting time.

The playlists are updated every time the ignition is switched off or connection of a USB memory stick. However, the system memorises these lists and if they are not modified, the loading time will be shorter.

Play starts automatically after a period which depends on the capacity of the USB memory stick.

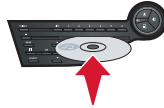

SELECTION OF SOURCE



The **SOURCE** or **SRC** button on the steering mounted controls allows a direct change to the next media source.

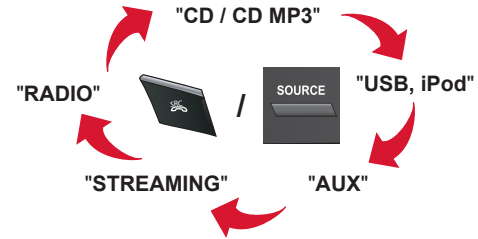

1



Press **MEDIA** to display the **"MEDIA"** menu.



2





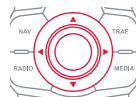

















Select **"Change media"** and confirm.



09 MUSIC MEDIA PLAYERS

SELECTING A TRACK

Previous track.	 / 
Next track.	 / 
Previous folder.	
Next folder.	
Fast forward.	Long press 
Fast backward.	Long press 
Pause: double press on the steering mounted Vol+/Vol- button or on Mute in the control panel.	 / 

LIST: List of USB or CD tracks or folders	
Up or down in the list.	 /  / 
Confirm, next menu level.	 /  / 
Up one menu level.	 +  /  / 

09 MUSIC MEDIA PLAYERS

CONNECTING APPLE® PLAYERS

- 1 Connect the Apple® player to the USB port using a suitable cable (not supplied).
Play starts automatically.

- 2 Control is via the audio system.

- i**
- The classifications available are those of the portable device connected (artists / albums / genres / playlists / audiobooks / podcasts).
The default classification used is by artist. To modify the classification used, return to the first level of the menu then select the desired classification (playlists for example) and confirm to go down through the menu to the desired track.
The "Shuffle tracks" mode on an iPod® corresponds to the "Random" mode on the audio system.
The "Shuffle albums" mode on an iPod® corresponds to the "Random all" on the audio system.
"Shuffle tracks" is restored by default on each connection.

- !**
- The version of software in the audio system may not be compatible with the generation of your Apple® player.

AUDIO STREAMING



Streaming allows audio files on your telephone to be played via the vehicle's speakers.

1

Connect the telephone: see "USING THE TELEPHONE".
Select "**Audio**" or "**All**" profile.

2

If play does not start automatically, it may be necessary to start the audio playback from the telephone.
Control is from the peripheral device or by using the audio system buttons.



Once connected in streaming mode, the telephone is considered to be a media source.
It is recommended that you activate "**Repeat**" on the Bluetooth peripheral.

09 MUSIC MEDIA PLAYERS

USING THE AUXILIARY INPUT (AUX)

Cable not supplied

1

Connect the portable device (MP3 player...) to the auxiliary JACK socket using an audio cable.



2



Press **MEDIA** to display the "**MEDIA**" menu.

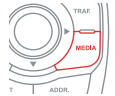

3



Select "**Activate / Deactivate AUX input**" and confirm.
First adjust the volume of your portable device (to a high level). Then adjust the volume of your audio system.

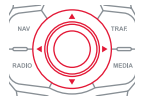

!

Display and management of the controls are via the portable device.

10 AUDIO SETTINGS

1



They are accessible by the **MUSIC** button in the control panel or by a long press on **RADIO** or **MEDIA** according to the source in use.

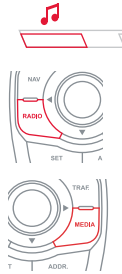

i

On-board audio: Arkamys® Sound Staging.

With Sound Staging, the driver and passengers are immersed in an "audio scene" recreating the natural atmosphere of an auditorium: truly a part of the scene and its surroundings.

This new sensation is made possible by software in the audio system which processes the digital signals from the media players (radio, CD, MP3...) without changing the audio settings. This processing takes account of the characteristics of the passenger compartment to produce optimum results.

The Arkamys® software installed in your audio system processes the digital signal from the media players (radio, CD, MP3, ...) and recreates a natural musical scene, with harmonious placement of instruments and voices in the space in front of passengers, level with the windscreen.

2

- "Equalizer" (choice of 6 musical ambiances)
- "Bass"
- "Treble"
- "Loudness" (Activate/Deactivate)
- "Distribution" ("Driver", "All passengers")
- "Le-Ri balance" (Left/Right)
- "Fr-Re balance" (Front/Rear)
- "Auto. Volume" depending on road speed (Activate/Deactivate)

!

The distribution (or spatialisation using the Arkamys® system) of sound is an audio process that allows the audio quality to be adapted to the number of listeners in the vehicle.

!

The audio settings (**Equalizer**, **Bass**, **Treble** and **Loudness**) are different and independent for each sound source.
The settings for distribution and balance are common to all sources.

11 CONFIGURATION

DISPLAY CONFIGURATION

1



Press **SETUP** to display the "Configuration" menu.



2



Select "**Display configuration**" and confirm.

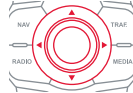

3a



Select "**Choose colour**" and confirm to select the screen colour harmony and the map presentation mode:

- day mode,
- night mode,
- automatic day/night mode, according to whether the headlamps are on.

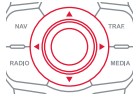

3b



Select "**Adjust luminosity**" and confirm to adjust the screen brightness. Press "**OK**" to save the changes. The settings for day and night are independent.

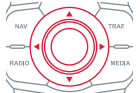

11 CONFIGURATION

VEHICLE SETTINGS

1



Press **SETUP** to display the "Configuration" menu.



2a



Select "**Vehicle parameters**" and confirm.

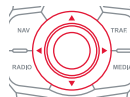

2b



Adjust the settings one by one. Then select "**OK**" on the screen and confirm to save the settings.

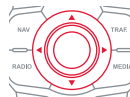

"SETUP" MENU

1 Vehicle parameters

2 Driving aids

3 Rear wiper with reverse gear

3 Automatic parking brake

3 Memorised speeds

2 Vehicle access

3 Driver openings selectivity

2 Driving lighting

3 Daytime running lamps

3 Directional headlamps

2 Comfort lighting

3 Welcome lighting

3 Guide me home lighting

12 SCREEN MENU MAP



MAIN FUNCTION

1 Option A

2 Option A1

3 Option A11

1 Option B...

"NAVIGATION - GUIDANCE" MENU

1 Select destination

2 Enter an address

2 Directory

2 GPS coordinates (Archive)

1 Journey leg and route

2 Add a stage

3 Enter an address

3 Directory

3 Previous destinations

2 Order/delete journey legs

2 Divert route

2 Chosen destination

1 Guidance options

2 Define calculation criteria

2 Set speech synthesis

2 Delete last destinations

2 Set parameters for risk areas

1 Map management

2 Map orientation

2 Map details

2 Move the map / "Vehicle monitoring"

2 Mapping and updating

2 Description of risk areas database

1 Stop / Restore guidance

"TRAFFIC INFORMATION" MENU

1 Geographic filter

2 Retain all the messages:

2 Retain the messages:

3 Around the vehicle

3 On the route

1 Select TMC station

2 Automatic TMC

2 Manual TMC

2 List of TMC stations

1 Display / Do not display messages

12 SCREEN MENU MAP

"TELEPHONE" MENU

- 1 Dial
- 1 Directory of contacts
- 1 Telephone options
 - 2 Ring options
- 1 Bluetooth functions
 - 2 List of the paired peripherals
 - 3 Connect
 - 3 Disconnect
 - 3 Delete
 - 3 Delete all
- 2 Peripherals search
- 2 Rename radiotelephone

"CONTACTS" MENU

- 1 Display contacts
 - 2 Open
 - 2 Import
 - 2 Delete
- 1 New contact
- 1 Configuration
 - 2 Delete all contacts
 - 2 Import all the entries
 - 2 Synchronization options
 - 3 No synchronization
 - 3 Display telephone contacts
 - 3 Display SIM card contacts
 - 3 Display all phone contacts
- 1 Contact mem. status

"RADIO" MENU

- 1 Following waveband
- 1 Options
 - 2 Activate / Deactivate TA
 - 2 Activate / Deactivate RDS
- 1 Audio settings
 - 2 Equalizer
 - 3 None
 - 3 Classical
 - 3 Jazz
 - 3 Rock
 - 3 Techno
 - 3 Vocal

12 SCREEN MENU MAP

- 2 Bass
- 2 Treble
- 2 Loudness
- 2 Distribution
- 3 Driver
- 3 All passengers
- 2 Le-Ri balance
- 2 Fr-Re balance
- 2 Auto. Volume
- 1 Update radio list

"MEDIA" MENU

- 1 Following media source
- 1 Eject USB support
- 1 Read mode
 - 2 Normal
 - 2 Random
 - 2 Random on all media
 - 2 Repetition
- 1 Audio settings (same as RADIO)
- 1 Activate / Deactivate AUX input

"SETUP" MENU

- 1 Display configuration
 - 2 Choose colour
 - 3 Harmony:
 - 3 Cartography:
 - 4 Day mode
 - 4 Night mode
 - 4 Auto Day/Night
 - 2 Adjust luminosity
 - 2 Set date and time
- 1 Voice synthesis
 - 2 Guidance instructions volume
 - 2 Select male voice / Select female voice
- 1 Vehicle settings

The settings vary according to the vehicle (see "Configuration").

FREQUENTLY ASKED QUESTIONS

The following table groups together the answers to the most frequently asked questions concerning your audio system.

QUESTION	ANSWER	SOLUTION
The route calculation is not successful.	The guidance criteria may conflict with the current location (exclusion of toll roads on a toll motorway).	Check the guidance criteria on the Navigation Menu, "Guidance options" \ "Define calculation criteria".
I am unable to enter my post code.	The system only accepts post codes of up to 5 characters.	
The POIs do not appear.	The POIs have not been selected.	Select the POIs in the list of POIs.
The risk areas audible warning does not work.	The audible warning is not active.	Activate audible warnings in the Guidance options menu, "Navigation - guidance", "Set parameters for risk areas".
The system does not suggest a detour around an incident on the route.	The guidance criteria do not take account of TMC messages.	Select the "Traffic info" function in the list of guidance criteria.
I receive a Risk area alert which is not on my route.	Other than guidance, the system announces all Risk areas positioned in a cone located in front of the vehicle. It may provide an alert for a Risk area located on nearby or parallel roads.	Zoom in on the map to view the exact position of the Risk area. Select "On the route" to no longer receive alerts other than guidance or to reduce the time for the announcement.

FREQUENTLY ASKED QUESTIONS

QUESTION	ANSWER	SOLUTION
Certain traffic jams along the route are not indicated in real time.	On starting, it is several minutes before the system begins to receive the traffic information.	Wait until the traffic information is being received correctly (display of the traffic information icons on the map).
	The filters are too restrictive.	Modify the "Geographic filter" settings.
	In certain countries, only major routes (motorways...) are listed for the traffic information.	This phenomenon is normal. The system is dependent on the traffic information available.
The altitude is not displayed.	On starting, the initialisation of the GPS may take up to 3 minutes to receive more than 4 satellites correctly.	Wait until the system has started up completely. Check that there is a GPS coverage of at least 4 satellites (long press on the SETUP button, then select "GPS coverage").
	Depending on the geographical environment (tunnel...) or the weather, the conditions of reception of the GPS signal may vary.	This phenomenon is normal. The system is dependent on the GPS signal reception conditions.
I am unable to connect my Bluetooth telephone.	The telephone's Bluetooth function may be switched off or the telephone may not be visible.	<ul style="list-style-type: none"> - Check that your telephone's Bluetooth function is switched on. - Check in the telephone settings that it is "visible to all".
	The Bluetooth telephone is not compatible with the system.	You can check the compatibility of your telephone on www.citroen.co.uk (services)
The volume of the telephone connected in Bluetooth mode is inaudible.	The volume depends both on the system and on the telephone.	Increase the volume of the audio system, to maximum if required, and increase the volume of the telephone if necessary.
	The ambient noise level has an influence on the quality of telephone communication.	Reduce the ambient noise level (close the windows, reduce the booster fan speed, slow down, ...).

FREQUENTLY ASKED QUESTIONS

QUESTION	ANSWER	SOLUTION
Some contacts are duplicated in the list.	The options for synchronizing contacts are synchronizing the contacts on the SIM card, the contacts on the telephone, or both . When both synchronizations are selected, some contacts may be duplicated.	Select "Display SIM card contacts" or "Display telephone contacts".
Contacts are not shown in alphabetical order.	Some telephones offer display options. Depending on the settings chosen, contacts can be transferred in a specific order.	Modify the display setting in the telephone directory.
The system does not receive SMS text messages.	The Bluetooth mode does not permit sending SMS text messages to the system.	
The CD is ejected automatically or is not played by the player.	<p>The CD is inserted upside down, is unplayable, does not contain any audio data or contains an audio format which the player cannot play.</p> <p>The CD has been recorded in a format that is not compatible with the player (udf, ...).</p> <p>The CD is protected by an anti-pirating protection system which is not recognised by the audio system.</p>	<ul style="list-style-type: none"> - Check that the CD is inserted in the player the right way up. - Check the condition of the CD: the CD cannot be played if it is too damaged. - Check the content in the case of a recorded CD: refer to the information and advice in the "MUSIC MEDIA PLAYERS" section. - The audio system's CD player does not play DVDs. - Some recorded CDs will not be played by the audio system because they are not of the correct quality.
There is a long waiting period following the insertion of a CD or connection of a USB memory stick.	When a new medium is inserted, the system reads a certain amount of data (directory, title, artist, etc.). This may take from a few seconds to a few minutes.	This phenomenon is normal.
The CD player sound is poor.	The CD used is scratched or of poor quality.	Insert good quality CDs and store them in suitable conditions.
	The audio equipment settings (bass, treble, ambiances) are unsuitable.	Set the treble or bass level to 0, without selecting an ambience.

FREQUENTLY ASKED QUESTIONS

QUESTION	ANSWER	SOLUTION
Some characters in the media information are not displayed correctly while playing.	The audio system does not display some types of characters.	Use standard characters to name tracks and folders.
Playing of streaming files does not start.	The peripheral device connected does not support automatic play.	Start the playback from the device.
The names of tracks and the track length are not displayed on the screen when streaming audio.	The Bluetooth profile does not allow the transfer of this information.	
The quality of reception of the radio station listened to gradually deteriorates or the stored stations do not function (no sound, 87.5 Mhz is displayed...).	The vehicle is too far from the transmitter used by the station listened to or there is no transmitter in the geographical area through which the vehicle is travelling.	Activate the "RDS" function by means of the short-cut menu to enable the system to check whether there is a more powerful transmitter in the geographical area.
	The environment (hills, buildings, tunnels, basement car parks...) block reception, including in RDS mode.	This phenomenon is normal and does not indicate a fault with the audio system.
	The aerial is absent or has been damaged (for example when going through a car wash or into an underground car park).	Have the aerial checked by a CITROËN dealer.
I cannot find some radio stations in the list of stations received.	The station is not received or its name has changed in the list.	
	Some radio stations send other information in place of their name (the title of the song for example).	
The name of the radio station changes.	The system interprets this information as the name of the station.	

FREQUENTLY ASKED QUESTIONS

QUESTION	ANSWER	SOLUTION
In changing the setting of treble and bass the equalizer setting is deselected.	The selection of an equalizer setting imposes the balance settings. Modifying one without the other is not possible.	Modify the balance or equalizer settings to obtain the desired musical ambience.
In changing the equalizer setting, treble and bass return to zero.		
When changing the balance settings, the distribution setting is deselected.	The selection of a distribution setting imposes the balance settings. Modifying one without the other is not possible.	Modify the balance or distribution settings to obtain the desired musical ambience.
When changing an distribution setting, the balance setting is deselected.		
There is a difference in sound quality between the different audio sources (radio, CD...).	For optimum sound quality, the audio settings for Volume, Bass, Treble, Equalizer and Loudness can be adapted to the different sound sources, which may result in audible differences when changing source (radio, CD...).	Check that the audio settings for (Volume, Bass, Treble, Equalizer, Loudness) are adapted to the sources listened to. It is advisable to set the AUDIO functions (Bass, Treble, Fr-Re balance, Le-Ri balance) to the middle position, select the "None", musical ambience and set the loudness correction to the "Active" position in CD mode or to the "Inactive" position in radio mode.

FREQUENTLY ASKED QUESTIONS

QUESTION	ANSWER	SOLUTION
With the engine off, the system switches off after a few minutes of use.	<p>When the engine is switched off, the system's operating time depends on the battery charge.</p> <p>The switch-off is normal: the system switches to economy mode and switches off to prevent discharging of the vehicle's battery.</p>	Start the vehicle's engine to increase the battery charge.
Playback of my USB memory stick starts only after a very long wait (around 2 to 3 minutes).	Some files supplied with the memory stick may greatly slow down access to reading the memory stick (multiplication by 10 of the catalogue time).	Delete the files supplied with the memory stick and limit the number of sub-folders in the file structure on the memory stick.
When I connect my iPhone as telephone and to the USB port at the same time, I am unable to play the music files.	When the iPhone connects automatically as a telephone, it forces the streaming function. The streaming function takes the place of the USB function which is then not useable, there is a period without sound of the track being played with Apple® players.	Disconnect and reconnect to the USB port (the USB function takes priority over streaming).
When I connect my Apple® player or my BlackBerry® to the USB port, I have alert messages on the current consumption by the USB port.	When charging, the current consumption of these smartphones is greater than the rating of the USB port, which is 500mA.	

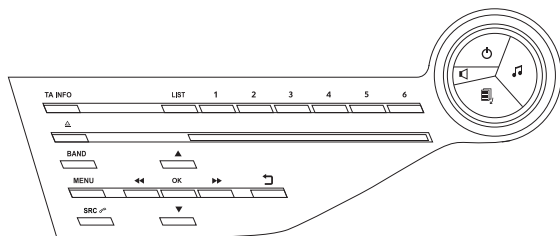

AUDIO SYSTEM / BLUETOOTH



The system is coded in such a way that it will only operate in your vehicle.



For safety reasons, the driver must only carry out operations which require prolonged attention while the vehicle is stationary.

When the engine is switched off and to prevent discharging of the battery, the audio system may switch off after a few minutes.

CONTENTS

01	First steps	p.	316
02	Steering mounted controls	p.	317
03	Main menu	p.	318
04	Audio	p.	319
05	Using the telephone	p.	329
06	Audio settings	p.	337
07	Screen menu map	p.	338
	Frequently asked questions	p.	340

01 FIRST STEPS

Display the list of stations received, CD/MP3 tracks or folders.
Long press: managing the classification of MP3/WMA files / update the list of stations received.

Select preset radio station.
Long press: store a station.

On / Off.

Volume adjustment.

Audio settings:
audio ambiances, treble, bass, loudness, distribution, left/right balance, front/rear fader, automatic volume.

TA (Traffic Announcement) function On / Off.
Long press: access to type of information.

Select the FM waveband (AM not available on Hybrid vehicles).

Access to main menu.

Select source:
Radio, CD, AUX, USB, Streaming.
Accept an incoming call.

Confirmation or display of contextual menu.

Manual step by step search up / down for radio frequencies.
Select previous / next MP3 folder.
Select previous / next folder / genre / artist / playlist in the USB device.
Navigation in a list.

Automatic search up / down for radio frequencies.
Select previous / next CD, USB, streaming track.
Navigation in a list.

Select screen display between modes:
Full screen: Audio (or telephone if call in progress) / In a window: Audio (or telephone if call in progress) - Time or Trip computer.
Long press: black screen (DARK).

Abandon the current operation.
Up one level (menu or folder).

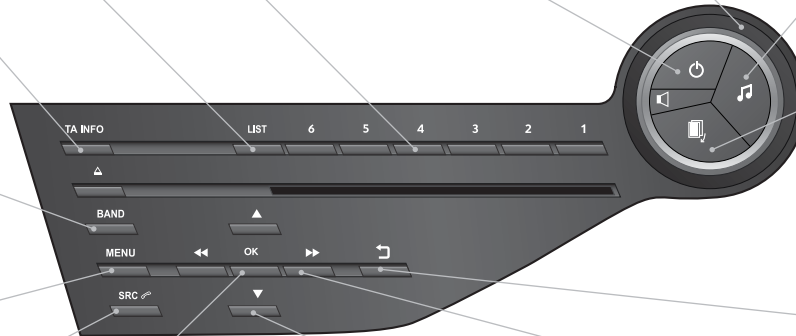

02 STEERING MOUNTED CONTROLS

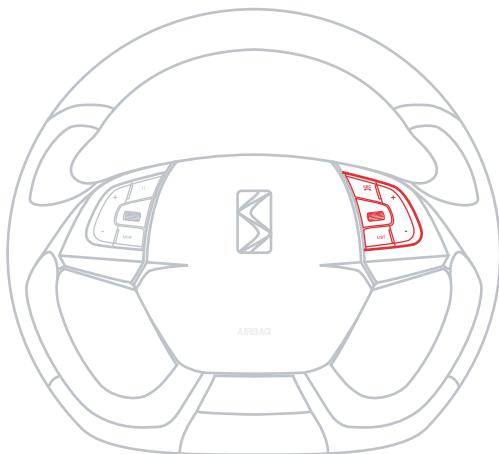

- Rotation
Radio -automatic selection of next / previous frequency.
Media: previous / next track.
- Press then rotation: access to 6 preset stations.



- Change the audio source.
- TEL button (short press):
Accept an incoming call
Call in progress: access to telephone menu: hang up, secret mode, hands-free mode.
- TEL button (long press):
Reject an incoming call or end a call in progress.
When not making a call, access to the telephone menu (Dial, Contacts, Calls log, Voice mailbox).



- Increase volume.
- Decrease volume.



- Radio: display the list of stations.
Media: display the list of tracks.

03 MAIN MENU

> SCREEN C

"Multimedia": Media parameters, Radio parameters.

"Bluetooth connection": Connections management, Search for a device.

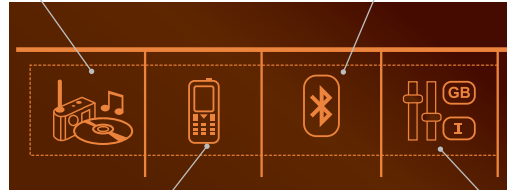

"Telephone": Call, Directory management, Telephone management, Hang up.

"Personalisation-configuration": Define the vehicle parameters, Choice of language, Display configuration, Choice of units, Date and time adjustment.



For a detailed global view of the menus available, refer to the "Screen menu map" section.

04 AUDIO

RADIO

SELECTING A STATION



The exterior environment (hills, buildings, tunnel, car park, below ground...) may prevent reception, even in RDS station tracking mode. This phenomenon is normal in the propagation of radio waves and is in no way indicative of a fault with the audio system.

1



Press **SOURCE** or **SRC** several times in succession and select radio.



2



Press **BAND** to select a waveband.



Press **LIST** to display the list of stations received in alphabetical order.



Select the desired radio station and confirm by pressing **OK**.



A press changes to the next or previous letter (e.g. A, B, D, F, G, J, K, ...).



1



A long press on **LIST** builds or updates the list of stations; audio reception is cut momentarily.

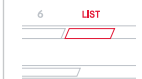

04 AUDIO

RDS

i RDS, if displayed, enables you to continue listening to the same station by automatic retuning to alternative frequencies. However, in certain conditions, coverage of an RDS station may not be assured throughout the country as radio stations do not cover 100 % of the territory. This explains the loss of reception of the station during a journey.

1  When the radio is displayed on the screen, press **OK** to display the contextual menu.



2  Select "**RDS**" and confirm to save. "**RDS**" is displayed in the screen.



RECEIVING TA MESSAGES

i The TA (Traffic Announcement) function gives priority to TA alert messages. To operate, this function needs good reception of a radio station transmitting this type of message. When a traffic report is transmitted, the current audio source (Radio, CD, USB, ...) is interrupted automatically to play the TA message. Normal playback of the audio source resumes at the end of the transmission of the message.

1  Press **TA INFO** to activate or deactivate the reception of traffic messages.



04 AUDIO

DISPLAY RADIO TEXT

! Radio text is information transmitted by the radio station related to the current programme or song.

SCREEN C

1



With the radio displayed on the screen, press **OK** to display the contextual menu.



2



Select "**RadioText (TXT) display**" and confirm **OK** to save.

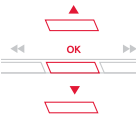

04 AUDIO

AUDIO CD

PLAYING A CD



Insert 12 cm diameter circular compact discs only.
Some anti-pirating systems, on original discs or CDs copied using a personal recorder, may cause faults which are no reflection on the quality of the original player.
Without pressing the **EJECT** button, insert a CD in the player, play begins automatically.

1



To play a disc which has already been inserted, press the **SOURCE** or **SRC** button several times in succession and select "CD".



2



Press one of the buttons to select a track on the CD.

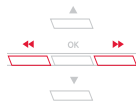

!



Press **LIST** to display the list of tracks on the CD.

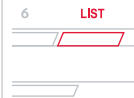

3



Press and hold one of the buttons for fast forward or backward.



04 AUDIO

CD, USB

INFORMATION AND ADVICE



The audio system will only play files with extension ".mp3" or ".wma" and a compression rate that is constant or variable between 32 Kbps and 320 Kbps.



It is advisable to restrict file names to 20 characters without using special characters (e.g. " ? ; ù) to avoid any playing or displaying problems.



The playlists accepted are types .m3u and .pls.
The number of files is limited to 5 000 in 500 directories on a maximum of 8 levels.



On a single disc, the CD player can read up to 255 MP3 files spread over 8 directory levels. However, it is recommended that this be kept to 2 levels so as to limit the time taken to access and play the CD. During play, the folder structure is not observed.



In order to be able to play a recorded CDR or CDRW, when recording it is preferable to select standards ISO 9660 level 1.2 or Joliet. If the disc is recorded in another format, it may not be played correctly. It is recommended that the same recording standard is always used for an individual disc, with as low a speed as possible (4x maximum) for optimum sound quality. In the particular case of a multi-session CD, the Joliet standard is recommended.



Do not connect a hard disk or USB device other than audio players to the USB port. This may cause damage to your installation.

04 AUDIO

CD, USB

PLAYING A COMPILATION



Insert an MP3 compilation in the CD player or connect a memory stick to the USB port, directly or via an extension lead.



The system creates playlists (temporary memory) the creation time for which can take from a few seconds to several minutes.

The playlists are updated every time the ignition is switched off or a USB memory stick is connected.

Play starts automatically after a period which depends on the capacity of the USB memory stick.



At a first connection, the order suggested is by folder. When connecting again, the order previously chosen is retained.

1



To play a disc or memory stick which has already been inserted, press **SOURCE** or **SRC** several times in succession and select "**CD**" or "**USB**".



2



Press one of the buttons to select the next or previous track.

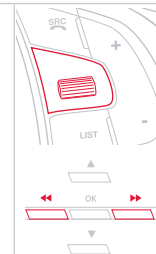

3



Press one of the buttons to select the next or previous folder in the order chosen.

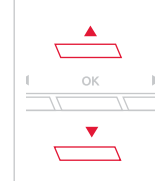

4



Press and hold one of the buttons for fast forwards or backwards.

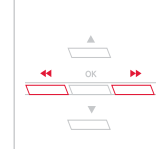







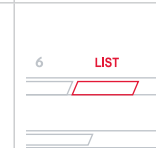



5

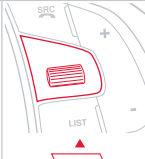

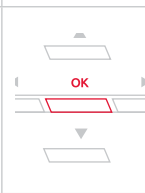

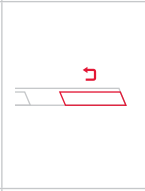

Press **LIST** to display the menu of folders in the compilation.



04 AUDIO

<p>6</p>   	<p>Select a line in the list.</p>  
<p>7</p> 	<p>Select a track or a folder.</p> 
<p>8</p> 	<p>Up a level in the menu.</p> 
<p>9</p>  	<p>Skip a track.</p> 

USB MEMORY STICK - FILE CLASSIFICATION

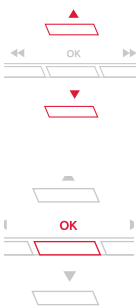
<p>1</p> 	<p>6 LIST</p> 
<p>2</p>   	<p>Having selected the desired classification ("By folders", "By artists", "By genres", "By playlists") press OK.</p> <p>Then confirm OK to save the modifications.</p> <ul style="list-style-type: none"> - By folders: all folders containing audio files recognised on the peripheral device, in alphabetical order without following the folder structure. - By artists: all of the artist names defined in the ID3 Tags, in alphabetical order. - By genres: all of the genres defined in the ID3 Tags. - By playlists: if playlists have been saved. 

04 AUDIO

APPLE® PLAYERS or PORTABLE PLAYER



The audio files on a Mass Storage portable player* can be heard through the vehicle's speakers by connecting it to the USB port (cable not supplied).



Management of the device is via the audio system controls.



If the portable player is not recognised by the USB port, connect it to the auxiliary Jack socket.



The Apple® player must be updated regularly for the best connection.



The playlists are those defined in the Apple® player.



The Apple® player must be generation 5 or later.

* Check your player's manual.

04 AUDIO

AUXILIARY SOCKET (AUX)

AUXILIARY JACK SOCKET



The auxiliary Jack socket permits the connection of a portable non-mass storage device or an Apple® player if not recognised by the USB port.



Do not connect a device to the USB port and to the auxiliary Jack socket at the same time.

1

Connect the portable device to the auxiliary Jack socket using a suitable cable (not supplied).



2



Press the **SOURCE** or **SRC** button several times in succession and select "**AUX**".



3

First adjust the volume on your portable device.



4



Then adjust the volume of the audio system.

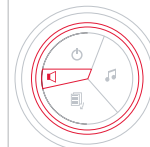

The display and management of controls is on the portable device.



04 AUDIO

STREAMING - PLAYING AUDIO FILES VIA BLUETOOTH



Depending on the compatibility of the phone



Streaming allows music files on a telephone to be heard via the vehicle's speakers.
The telephone must support the appropriate bluetooth profiles (Profiles A2DP / AVRCP).

1



Pair/connect the telephone: see the "USING THE TELEPHONE" section.

2



Activate the streaming source by pressing **SOURCE** or **SRC**. Control of playback is via the audio system. The contextual information can be displayed in the screen.



In certain cases, playing of the audio files must be initiated from the telephone.



The audio quality depends on the quality of the transmission from the telephone.

PLAY MODE



The play modes available are:

- Normal: the tracks are played in order, depending on the classification of the selected files.
- Random: the tracks in an album or folder are played in a random order.
- Random all: all of the tracks saved in the media are played in random order.
- Repeat: the tracks played are only those from the current album or folder.

1



Press **OK** for access to the contextual menu.
or
Press **MENU**.



2



Select "**Multimedia**" and confirm.



3



Select "**Media parameters**" and confirm.



4



Select "**Read mode**" and confirm.



5



Select the desired play mode and confirm **OK** to save the modifications.



05 USING THE TELEPHONE

PAIRING A TELEPHONE FIRST CONNECTION



The services offered depend on the network, the SIM card and the compatibility of the Bluetooth telephone used. Consult your telephone's manual and your operator to find out which services are available to you.



For safety reasons and because they require prolonged attention on the part of the driver, the operations for pairing of the Bluetooth mobile telephone with the Bluetooth hands-free system of your audio system must be carried out with the **vehicle stationary** and the ignition on. Visit www.citroen.co.uk for more information (compatibility, additional help, ...).

1

Activate the telephone's Bluetooth function and ensure that it is "visible to all" (refer to the telephone user guide).



2



Press **MENU**.



3



Select "**Bluetooth connection**" and confirm.

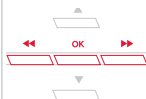

4



Select "**Search for a device**".



5

A window is displayed "**Search in progress...**".

6



Select the telephone to be connected from the list. Only one telephone can be connected at a time.

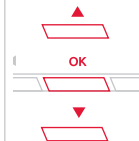

05 USING THE TELEPHONE



In some cases, the reference number of the telephone or the Bluetooth address may appear instead of the name of the telephone.

7



A virtual keypad is displayed on the screen: enter a code with at least 4 digits and conform with **OK**.

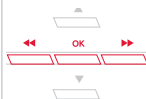

8

A message is displayed on the screen of the telephone: enter the same code and confirm.



If pairing fails, try again; the number of attempts is not limited.

9

Accept the connection to the telephone.

10

A message appears in the screen to confirm the result of the connection.



Pairing can also be initiated from the telephone by searching for detected Bluetooth devices.



The directory and the calls list can be accessed after the synchronisation period (if the telephone is compatible). Automatic connection must be configured in the telephone to allow the connection each time the vehicle is started.

STREAMING - PLAYING AUDIO FILES VIA BLUETOOTH

1

Pair/connect the telephone then listen: see the AUDIO section.

05 USING THE TELEPHONE

MANAGING CONNECTIONS

i The telephone connection automatically includes hands free operation and audio streaming.
The ability of the system to connect to just one profile depends on the telephone. Both profiles may connect by default.

1  Press **MENU**.





2  Select **"Bluetooth connection"** and confirm.



3  Select **"Connections management"** and confirm. The list of paired telephones is displayed.



  Indicates that a device is connected.

 Indicates connection of the audio streaming profile.

 Indicates connection of the hands-free profile.

4  Select a telephone and confirm.







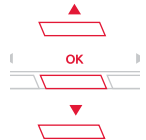

















5  Then select and confirm:

- **"Connect telephone"** / **"Disconnect telephone"**: to connect / disconnect the telephone or the hands-free connection only.
- **"Connect media player"** / **"Disconnect media player"**: to connect / disconnect only streaming.
- **"Connect telephone + media player"** / **"Disconnect telephone + media player"**: to connect / disconnect the telephone (hands-free and streaming).
- **"Delete connection"**: to delete the pairing.

















05 USING THE TELEPHONE

MAKING A CALL - DIALLING

<p>1</p>  	<p>To display the "TELEPHONE" menu:</p> <ul style="list-style-type: none"> - Make a long press on SOURCE or SRC. - Or, press OK to display the contextual menu. Select "Call" and confirm. - Or, press MENU, select "Telephone" and confirm. Select "Call" and confirm. 	 
<p>2</p>   	<p>Select "Dial" to enter a number and confirm.</p>	  
<p>3</p>   	<p>Select numbers one at a time using the ◀ and ▶ buttons and confirm.</p>	  
<p> Correction allows numbers to be deleted one at a time.</p>		
<p>4</p>   	<p>Select OK and confirm to start the call.</p>	  

MAKING A CALL - RECENTLY CALLED NUMBERS*

<p>1</p> 	<p>To display the "TELEPHONE" menu:</p> <ul style="list-style-type: none"> - Make a long press on SRC/TEL. - Or, press the dial to display the contextual menu. Select "Call" and confirm. - Or, press MENU, select "Telephone" and confirm. Select "Call" and confirm. 	 
<p>2</p>   	<p>Select "Calls list" and confirm.</p>	  
<p>3</p>   	<p>Select the number and confirm to start the call.</p>	  
<p>i The calls list includes calls sent and received in the vehicle using the connected telephone.</p>		
<p>! It is possible to make a call directly from the telephone; park the vehicle first as a safety measure.</p>		

* Depending on the compatibility of the telephone.

05 USING THE TELEPHONE

MAKING A CALL - FROM THE DIRECTORY

1

To display the **"TELEPHONE"** menu:

- Make a long press on **SRC/TEL**.
- Or, press the dial to display the contextual menu. Select **"Call"** and confirm.
- Or, press **MENU**, select **"Telephone"** and confirm. Select **"Call"** and confirm.



2



Select **"Directory"** and confirm.



3

Select a contact then confirm.



Home
Business
Mobile

(depending on the information available in the contact records of the telephone connected).

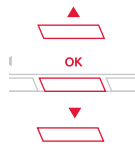

4



Select the number and confirm.

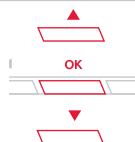

RECEIVING A CALL

1

An incoming call is announced by a ring and a superimposed display in the multifunction screen.

2

"YES" to accept the call is selected by default.

Press **OK** to accept the call.

Select **"NO"** and confirm to reject the call.

or

Press one of these buttons to accept the call.



A long press on **ESC** or on **TEL, SOURCE** or **SRC** also rejects an incoming call.

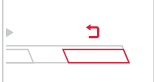

05 USING THE TELEPHONE

MANAGING CALLS

1



During a call, press **OK** to display the contextual menu.



Secret - Mute

(so that the caller cannot hear)

2b



In the contextual menu:

- select **"Micro OFF"** to switch off the microphone.
- deselect **"Micro OFF"** to switch the microphone on.



Hang up

2a



In the contextual menu, select **"Hang up"** to end the call.

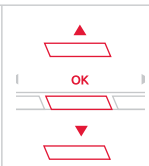

Combined mode

(to leave the vehicle without ending the call)

2c



In the contextual menu:

- select **"Telephone mode"** to transfer the call to the telephone.
- deselect **"Telephone mode"** to transfer the call to the vehicle.

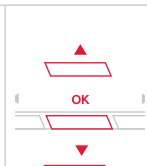

A long press on one of these buttons also ends the call.



In certain cases, the combined mode has to be activated from the telephone.

If the contact has been cut off, when you reconnect on returning to the vehicle, the Bluetooth connection will be restored automatically (depending on the compatibility of the telephone).

05 USING THE TELEPHONE

Interactive voice response

2d



From the contextual menu, select "**DTMF tones**" and confirm to use the digital keypad to navigate in the interactive voice response menu.

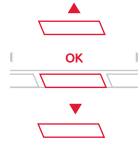

Consultation call

2e



From the contextual menu, select "**Switch**" and confirm to return to a call left on hold.



05 USING THE TELEPHONE

DIRECTORY



The telephone directory is sent to the system, depending on the compatibility of the telephone.



The directory is provisional and depends on the Bluetooth connection.



Contacts imported from the telephone to the audio system directory are saved in a permanent directory visible to all, whatever the telephone connected.

1



Make a long press on **SOURCE** or **SRC** for access to the directory or press **OK**, and select **"Call"** and confirm.



2



Select **"Directory"** to see the list of contacts.



3



To modify the contacts saved in the system, press **MENU** then select **"Telephone"** and confirm.

Select **"Directory management"** and confirm.

You can:

- **"Consult an entry"**,
- **"Delete an entry"**,
- **"Delete all entries"**.



06 AUDIO SETTINGS

SCREEN C



1



Press  to display the audio settings menu.



2

The settings available are:

- Ambience,
- Bass,
- Treble,
- Loudness,
- Distribution: Personalised or Driver,
- Left / right balance,
- Fader (front / rear balance),
- Auto. volume.

3



Select and confirm "**Other settings...**" to display the next setting in the list.



The distribution (or spatialisation using the Arkamys® system), is an audio process which allows the sound quality to be improved according to the setting chosen, corresponding to the position of the listeners in the vehicle.



The Ambience, Treble and Bass audio settings are different and independent for each sound source.



On-board audio: Arkamys® Sound Staging.

With Sound Staging, the driver and passengers are immersed in an "audio scene" recreating the natural atmosphere of an auditorium: truly a part of the scene and its surroundings.

This new sensation is made possible by software in the audio system which processes the digital signals from the media players (radio, CD, MP3...) without changing the audio settings. This processing takes account of the characteristics of the passenger compartment to produce optimum results.

The Arkamys® software installed in your audio system processes the digital signal from the media players (radio, CD, MP3, ...) and recreates a natural musical scene, with harmonious placement of instruments and voices in the space in front of passengers, level with the windscreen.

07 SCREEN MENU MAP

SCREEN C

MAIN FUNCTION

1 Option A

2 Option A1

3 Option A11

1 Option B...

3 By folders

3 By artists

3 By genres

3 By playlists

1 Radio parameters

1 Directory management

2 Consult an entry

2 Delete an entry

2 Delete all entries

1 Telephone management

2 Telephone status

1 Hang up

MEDIA

1 Media parameters

2 Choice of playback mode

3 Normal

3 Random

3 Random all

3 Repeat

2 Choice of track listing

TELEPHONE

1 Call

2 Dial

2 Directory

2 Calls list

2 Voice mail box

BLUETOOTH CONNECTION

1 Connections management

1 Search for a device

07 SCREEN MENU MAP

PERSONALISATION- CONFIGURATION

1 Define the vehicle parameters

2 Access to the vehicle

3 Plip action

3 Driving position setting

3 Unlocking boot only

2 Driving assistance

3 Rear wiper in reverse gear

3 Parking brake automatic

3 Speeds memorised

2 Vehicle lighting

3 Daytime lights

3 Directional headlamps

2 Interior lighting

3 Welcome lighting

3 Follow-me-home headlamps

1 Choice of language

1 Display configuration

2 Choice of units

2 Date and time adjustment

2 Display parameters

2 Brightness

1 Choice of sounds

FREQUENTLY ASKED QUESTIONS

The following tables contain answers to the most frequently asked questions.

QUESTION	ANSWER	SOLUTION
There is a difference in sound quality between the different audio sources (radio, CD...).	For optimum sound quality, the audio settings (Volume, Bass, Treble, Ambience, Loudness) can be adapted to the different sound sources, which may result in audible differences when changing source (radio, CD...).	Check that the audio settings (Volume, Bass, Treble, Ambience, Loudness) are adapted to the sources listened to. It is advisable to set the AUDIO functions (Bass, Treble, Front-Rear Fader, Left-Right Balance) to the middle position, select the musical ambience "None" and set the loudness correction to the "Active" position in CD mode or to the "Inactive" position in radio mode.
When changing the settings for treble and bass, the ambience setting is deselected. When changing the ambience setting, treble and bass are reset to zero.	Choosing an ambience imposes settings for treble and bass. Modifying one without the other is not possible.	Modify the treble and bass settings or the ambience setting to obtain the desired sound quality.
When changing the balance setting, distribution is deselected.	Choosing a distribution setting imposes a balance setting. Modifying one without the other is not possible.	Modify the balance setting or the distribution setting to obtain the desired sound quality.

FREQUENTLY ASKED QUESTIONS

QUESTION	ANSWER	SOLUTION
<p>The quality of reception of the radio station listened to gradually deteriorates or the stored stations do not function (no sound, 87.5 MHz is displayed...).</p>	<p>The vehicle is too far from the transmitter used by the station listened to or there is no transmitter in the geographical area through which the vehicle is travelling.</p>	<p>Activate the RDS function to enable the system to check whether there is a more powerful transmitter in the geographical area.</p>
	<p>The environment (hills, buildings, tunnels, basement car parks...) block reception, including in RDS mode.</p>	<p>This phenomenon is normal and does not indicate a failure of the audio equipment.</p>
	<p>The aerial is absent or has been damaged (for example when going through a car wash or into an underground car park).</p>	<p>Have the aerial checked by a CITROËN dealer.</p>
<p>Sound cut-outs of 1 to 2 seconds in radio mode.</p>	<p>During this brief sound cut-out, the RDS searches for any frequency permitting better reception of the station.</p>	<p>Deactivate the RDS function if the phenomenon is too frequent and always on the same route.</p>
<p>The traffic announcement (TA) is displayed. I do not receive any traffic information.</p>	<p>The radio station does not broadcast traffic information.</p>	<p>Tune to a radio station which broadcasts traffic information.</p>
<p>The stored stations are not found (no sound, 87.5 MHz is displayed...).</p>	<p>An incorrect waveband is selected.</p>	<p>Press the BAND button to return to the waveband on which the stations are stored.</p>

FREQUENTLY ASKED QUESTIONS

QUESTION	ANSWER	SOLUTION
The CD is ejected automatically or is not played by the player.	The CD is inserted upside down, is unplayable, does not contain any audio data or contains an audio format which the player cannot play. The CD is protected by an anti-pirating protection system which is not recognised by the audio equipment.	<ul style="list-style-type: none"> - Check that the CD is inserted in the player the right way up. - Check the condition of the CD: the CD cannot be played if it is too damaged. - Check the content in the case of a recorded CD: consult the advice in the "Audio" section. - The audio equipment's CD player does not play DVDs. - Due to their quality level, certain writeable CDs will not be played by the audio system.
The CD player sound is poor.	The CD used is scratched or of poor quality.	Insert good quality CDs and store them in suitable conditions.
	The audio settings (bass, treble, ambience) are unsuitable.	Set the treble or bass level to 0, without selecting an ambience.
I am unable to connect my Bluetooth telephone.	It is possible that Bluetooth is switched off on the telephone or that the telephone has not been made not visible.	<ul style="list-style-type: none"> - Check that your telephone has Bluetooth switched on. - Check in the telephone's settings that it is "Visible to all".
	The Bluetooth telephone is not compatible with the system.	You can check the compatibility of your telephone on www.citroen.co.uk (services)
The Bluetooth connection is cut.	The battery of the peripheral may not be sufficiently charged.	Recharge the battery of the peripheral device.

FREQUENTLY ASKED QUESTIONS

QUESTION	ANSWER	SOLUTION
The message "USB device error" is displayed on the screen.	The USB memory stick is not recognised. The memory stick may be corrupt.	Reformat the memory stick (FAT 32).
A telephone connects automatically, disconnecting another telephone.	Automatic connection overrides manual connection.	Modify the telephone settings to remove automatic connection.
The Apple® player is not recognised when connecting to the USB port.	The Apple® player is of a generation that is not compatible with the USB.	Connect the Apple® player to the AUX Jack socket using a suitable cable (not supplied).
When I connect my Apple® player or my BlackBerry® to the USB port, I have alert messages on the current consumption by the USB port.	When charging, the current consumption of these smartphones is greater than the rating of the USB port, which is 500mA.	
The hard disk or device is not recognised when connecting to the USB port.	Some hard disks and devices need a power supply greater than is provided by the audio system.	Connect the device to the 230 V socket, the 12 V socket or an external power supply. Caution: ensure that the device does not transmit a voltage greater than 5 V (risk of destruction of the system).
When streaming, the sound cuts momentarily.	Some telephones prioritise connection of the "hands-free" profile.	Delete the "hands-free" connection profile to improve streaming.

FREQUENTLY ASKED QUESTIONS

QUESTION	ANSWER	SOLUTION
In "Random all" play, not all of the tracks are played.	In "Random all" play, the system can only take into account up to 999 tracks.	
With the engine off, the audio system switches off after a few minutes of use.	When the engine is switched off, the audio system operating time depends on the battery charge. The switch-off is normal: the audio system switches to economy mode and switches off to prevent discharging the vehicle's battery.	Start the vehicle's engine to increase the battery charge.
The message "the audio system is overheated" appears on the display.	In order to protect the installation if the surrounding temperature is too high, the audio system switches to an automatic thermal protection mode leading to a reduction of the volume or stopping of the playing of the CD.	Switch the audio system off for a few minutes to allow the system to cool.

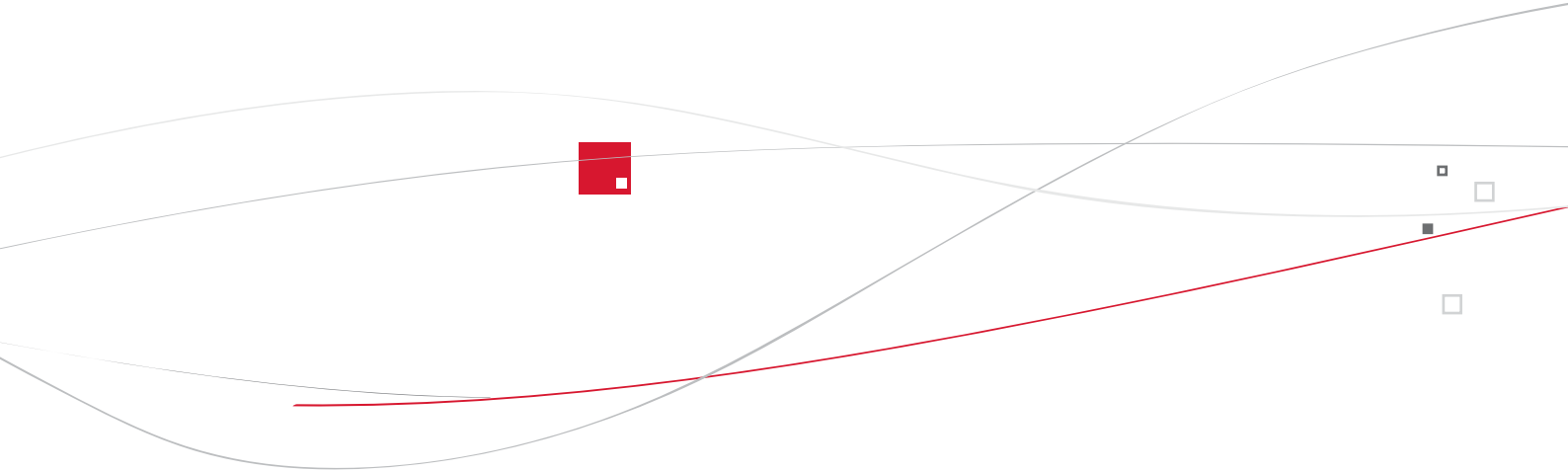

Index

Alphabetical index - Visual search

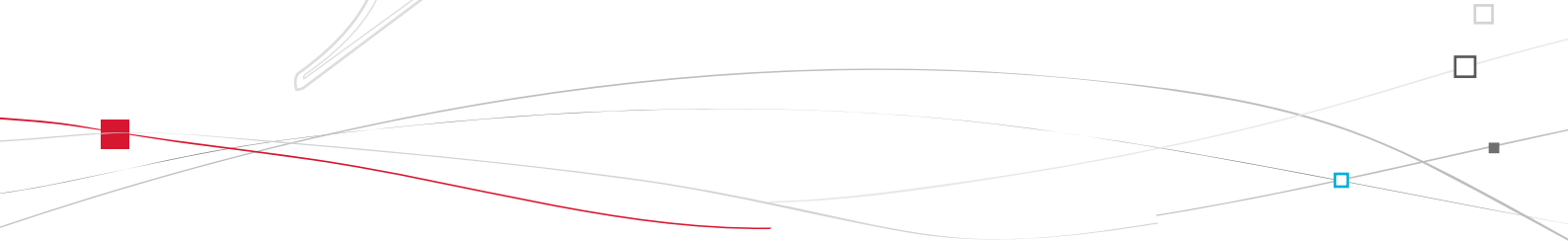



A

ABS	187
Accessories	33, 83, 234
Accessory position.....	33, 83
Accessory socket, 12 V	110, 111
Adjusting headlamps	160
Adjusting head restraints	100, 103
Adjusting seat belt height	191
Adjusting the steering wheel.....	109
Airbags	67, 195
Airbags, curtain.....	195, 196
Airbags, front	193, 196
Airbags, lateral.....	195, 196
Air conditioning	47, 120
Air conditioning, digital.....	117, 118
Air filter	246
Air flow	47
Air vents.....	116
Alarm	89
Anti-lock braking system (ABS).....	187
Anti-pinch.....	93
Anti-theft	33
Armrest	110
Armrest, front.....	112
Armrest, rear.....	113
Ashtray, portable.....	110
ASR	187
Assistance, emergency braking.....	187
Assistance call.....	185, 259
Audible warning.....	185
Audio streaming (Bluetooth).....	301, 328, 330
Audio system	315
Automatic headlamps	60, 157
Automatic illumination of headlamps	153, 156

Automatic operation of hazard warning lamps	184
Automatic rain sensitive windscreens wipers	163, 165
Auxiliary socket.....	112, 301, 302, 327

B

Backup starting.....	34, 226
Backup switching off.....	34
Battery	8, 28, 50-52, 107, 225-227, 245
Battery, charging.....	226
Battery, remote control	85, 86
Black panel	73
Bluetooth (hands-free).....	284, 329
Bluetooth (telephone).....	284, 329
Boot	88
Boot (opening).....	80
Boot floor, adjustable	114
Brake discs	247
Brake lamps.....	219
Brake pads	247
Brakes	62, 247

C

Capacity, fuel tank	95
Cables, high voltage.....	52
CD	298, 322
CD MP3.....	298, 323, 324
Central locking.....	80, 82
Changing a bulb	214-221
Changing a fuse	222
Changing a wheel.....	206
Changing a wiper blade.....	166, 229
Changing the date	74, 75, 305
Changing the remote control battery.....	85
Changing the time	74, 75, 305
Checking levels	242, 243, 245
Checking the engine oil level.....	71
Checking tyre pressures (using the kit).....	200
Checks	240, 245-247
Children	172-181, 192, 194
Child lock	181
Child seats	172-180
Child seats, conventional.....	175, 176
Cigar lighter	111
Clock	74
Closing the boot.....	88
Closing the doors.....	80, 82
Connectors, audio	112, 301, 302, 327
Coolant level.....	68, 243
Coolant temperature indicator	68
Courtesy lamps.....	167
Cruise control	142, 145
Cup holder	110

D

Date (setting)..... 74, 75, 305
 Daytime running lamps..... 214, 217, 218
 Deactivating ESP..... 189
 Deactivating the passenger airbag..... 194
 Deadlocking..... 83, 84
 Defrosting..... 108, 122
 Demisting..... 122
 Diesel..... 42, 46, 61
 Diesel additive level..... 244
 Dimensions..... 253
 Dipped beam..... 60, 152, 214, 215
 Dipstick..... 71, 242
 Directional lighting..... 161, 162
 Direction indicators..... 158, 184, 214, 217, 219
 Driving positions (memorising)..... 102
 Dynamic emergency braking..... 126-131
 Dynamic stability control
 (DSC)..... 63, 66, 187, 189

E

EBA (Emergency braking assistance)..... 187
 EBFDF..... 187
 Eco-driving..... 47
 Economical driving..... 47
 Economy mode..... 228
 Eco off..... 46
 Electronic brake force distribution (EBFD) 187
 Electronic engine immobiliser..... 33, 86
 Electronic gearbox..... 135, 227, 247
 Emergency boot release..... 88
 Emergency call..... 185, 259

Emergency warning lamps..... 115, 184
 eMyWay..... 73, 261
 Energy economy mode..... 228
 Engine, Diesel..... 97, 240, 241, 251
 Engine compartment..... 53, 240
 Engine compartment fusebox..... 222
 Engine oil level indicator..... 71, 242
 Engines..... 250, 251
 Environment..... 9, 47, 85, 117, 122, 245

F

Filling with fuel..... 95-97
 Fitting a wheel..... 211
 Fitting roof bars..... 233
 Fittings, boot..... 114
 Flashing indicators..... 158, 184
 Flat bed lorry or trailer..... 55, 231
 Foglamps, front..... 154, 162, 214, 218
 Foglamps, rear..... 154, 219, 220
 Folding/unfolding
 the door mirrors..... 108
 Front seats..... 100-102
 Fuel..... 47, 97
 Fuel consumption..... 47, 49
 Fuel consumption figures..... 49
 Fuel filler cap..... 95
 Fuel filler flap..... 95, 96
 Fuel gauge..... 21, 57, 95
 Fuel tank..... 95, 96
 Fusebox, dashboard..... 223
 Fuses..... 222

G

G.P.S. 267
 Gearbox, electronic..... 135, 247
 Gear lever, electronic gearbox system..... 135
 Guidance..... 267
 Guide-me-home..... 156, 158

H

Halogen headlamps..... 214
 Hands-free kit..... 284, 329
 Hazard warning lamps..... 115, 184
 Head-up display..... 140, 143, 145
 Headlamp adjustment..... 160
 Headlamps, directional..... 161, 214
 Headlamp wash..... 164, 244
 Head restraints, front..... 100, 103
 Head restraints, rear..... 107
 Heated seats..... 104
 Heating..... 47, 116
 Height and reach adjustment,
 steering wheel..... 109
 High voltage..... 50, 52, 227, 239
 Hill start assist..... 134
 History..... 49
 Hybrid..... 8, 26-54
 Hybrid flow..... 40
 Hybrid selector..... 35
 Hybrid system..... 8, 26-54

I

Identification plates.....	254
Ignition.....	33, 83
Ignition on.....	33, 83
Indicator lamps, status.....	59-67
Indicators, direction.....	184, 217, 219
Inflating accessories (using the kit).....	205
Inflating tyres.....	47, 254
Inputs for audio system.....	112, 301, 302, 327
Instrument panel lighting.....	72
Instrument panels.....	58
Instruments and controls.....	16
Intelligent Traction Control.....	188
Interior fittings.....	110
Interior mood lighting.....	168
ISOFIX child seats.....	178-180
ISOFIX mountings.....	178

J

Jack.....	206
JACK socket.....	112, 301, 302, 327

K

Keeping children safe.....	172-181, 192, 194
Key.....	80-86
Key, electronic.....	34, 80-84
Keyless Entry and Starting.....	81, 86
Key not recognised.....	34
Key with remote control.....	33

L

Labels, identification.....	254
Lamps, warning and indicator.....	59-67
Lane Departure Warning System (LDWS)	139
LED daytime running lamps.....	155
Level, brake fluid.....	243
Level, headlamp wash.....	244
Level, power steering fluid.....	243
Levels and checks.....	240-246
Lighting.....	168
Lighting, guide-me home.....	156, 158
Lighting, interior.....	167, 168
Lighting bulbs (replacement).....	214-221
Lighting control stalk.....	152, 158
Lighting dimmer.....	72
Lighting on reminder.....	155
Loading.....	47, 233
Load reduction mode.....	228
Localised assistance call.....	259
Localised emergency call.....	259
Locating your vehicle.....	87
Locking from the inside.....	87
Locking the doors.....	87
Long objects, transporting.....	113
Low fuel level.....	96
Lumbar.....	100, 101

M

Main beam.....	60, 152, 214-216, 218
Maintenance.....	47
Markings, identification.....	254
Massage function.....	104

Mat.....	111
Menu, main.....	318
Mirror, rear view.....	109
Mirrors, door.....	108
Misfuel prevention.....	96
Motorway function (direction indicators).....	184
Mountings for ISOFIX seats.....	178
MP3 CD.....	296, 323, 324
Music media players.....	297

N

Navigation.....	267
Number plate lamps.....	221

O

Oil filter.....	246
Oil level.....	71, 242
Opening the boot.....	80, 81, 88
Opening the doors.....	80, 81
Operation indicator lamps.....	59-67

P

Paint colour code 254
 Parking brake, electric 61, 65, 126-133, 247
 Parking lamps 158
 Parking sensors, front 148
 Parking sensors, rear 147
 Particle emission filter 244, 246, 298
 Passenger compartment
 filter 246
 Player, CD MP3 323, 324
 Port, USB 112, 298, 325
 Power 38
 Priming the fuel system 241
 Protecting children 172-181, 192, 194
 Puncture 200

R

Radio 294-319
 Ready lamp 35
 Rear foglamp 154, 220
 Rear screen (demisting) 108, 122
 Recharging the battery 226
 Reduction of electrical load 228
 Regeneration of the particle
 emissions filter 246
 Reinitialising the remote control 85
 Remote control 80-86
 Removing a wheel 209
 Removing the mat 111
 Repair kit, puncture 200
 Replacing bulbs 214-221
 Replacing fuses 222-224

Replacing the air filter 246
 Replacing the oil filter 246
 Replacing the passenger
 compartment filter 246
 Replacing wiper blades 166, 229
 Reset history 49
 Resetting the service indicator 70
 Resetting the trip recorder 72
 Reversing camera 149
 Reversing lamp 219
 Risk areas (update) 272
 Roof bars 233
 Routine checks 242-247
 Running out of fuel (Diesel) 241

S

Screen, colour and mapping 265
 Screen, instrument panel 57, 76
 Screen, monochrome 318, 338
 Screen, multifunction
 (with audio equipment) 318
 Screen menu map 306, 338, 339
 Screenwash, front 164
 Screenwash fluid level 244
 Seat, rear bench 105, 107
 Seat adjustment 100, 101
 Seat belts 190-192
 Seats, rear 105-107
 Serial number, vehicle 254
 Service indicator 69
 Servicing 47

Setting the clock 74, 75
 Short-cut menus 266
 Sidelamps 152, 155, 158, 214, 217-219
 Side repeater 218
 Ski flap 113
 Snow chain 254
 Snow chains 213
 Spare wheel 206
 Speed limiter 142, 143
 Speedometer 38, 58
 Spotlamps, side 159, 218
 Starting the vehicle 31, 34, 135
 Steering mounted controls,
 audio 264, 317
 Stopping the vehicle 31, 34, 135
 Stop & Start 95, 119, 122,
 225, 239, 241-243, 245
 Storage 110, 112-114
 Storing driving positions 102
 Switching off the engine 31, 34
 Synchronising the remote
 control 85
 Synthesiser, voice 278
 System, navigation 267

T

Table of weights.....	252
Tables of engines.....	250, 251
Tables of fuses.....	222
Tank, fuel.....	96
Technical data.....	250-252
Telephone.....	284, 329
Temperature, coolant.....	68
Temperature control for heated seats.....	104
Temporary tyre repair kit.....	200
Third brake lamp.....	221
Time.....	74, 75
TMC (Traffic info).....	281
Tools.....	206
Total distance recorder.....	72
Towbar.....	231
Towed loads.....	252
Towing another vehicle.....	55, 229-231
Traction control (ASR).....	63, 66, 187
Traffic information (TA).....	282, 320
Traffic information (TMC).....	281, 282
Trailer.....	231
Trip computer.....	76, 77
Trip distance recorder.....	72
Tyre pressures.....	201, 254
Tyres.....	47, 254
Tyre under-inflation detection.....	186

U

Under-inflation (detection).....	186
Unlocking.....	80, 81
Unlocking from the inside.....	87
Unlocking the boot.....	80
Unlocking the doors.....	87
Update risk areas.....	273
Updating the date.....	74, 75
Updating the time.....	74, 75
USB player.....	112, 298, 324

V

Vehicle identification.....	254
Ventilation.....	116, 117
Visibility.....	122

W

Warning lamps.....	59-67
Warning triangle.....	115
Wash-wipe, rear.....	164
Washing (advice).....	54
Weights.....	252
Welcome lighting.....	159
Window controls.....	91
Wiper, rear.....	164
Wiper control stalk.....	163-165
Wipers.....	62, 163, 165

X

Xenon headlamps.....	214
----------------------	-----

Exterior

Welcome lighting 159
 Directional lighting 161
 Cornering lighting 162
 Headlamp height adjustment..... 160
 Changing bulbs..... 214-218
 - front lamps
 - foglamps
 - direction indicator repeaters

Door mirrors..... 108
 Door mirror spotlamps 159

Doors..... 80-84, 87
 - Keyless Entry and Starting
 - opening / closing
 - central locking
 - emergency procedure
 Alarm 89-90

Fuel tank, misfuel prevention 95-97

Cockpit glass roof 93-94
 Roof bars 233
 Accessories 234-235

ESC: ABS, EBA, ASR, DSC 187-189
 Tyre under-inflation detection 186
 Tyre pressures 254
 Changing a wheel..... 206-212
 - tools
 - removing / refitting
 Snow chains 213
 Temporary puncture repair kit..... 200-205

Electronic key / Keyless Entry and Starting 31-34, 80-86
 - opening / closing
 - anti-theft protection
 - battery
 - starting
 - accessory position

Wipers 163-166
 Changing a wiper blade..... 166, 229

Boot 80, 88
 - opening / closing
 - emergency release

Changing bulbs..... 219-221
 - rear lamps
 - 3rd brake lamp
 - number plate lamps
 - foglamps

Parking sensors 147-148
 Reversing camera 149
 Recovery (flat bed) 55, 229-231
 Towbar 231-232

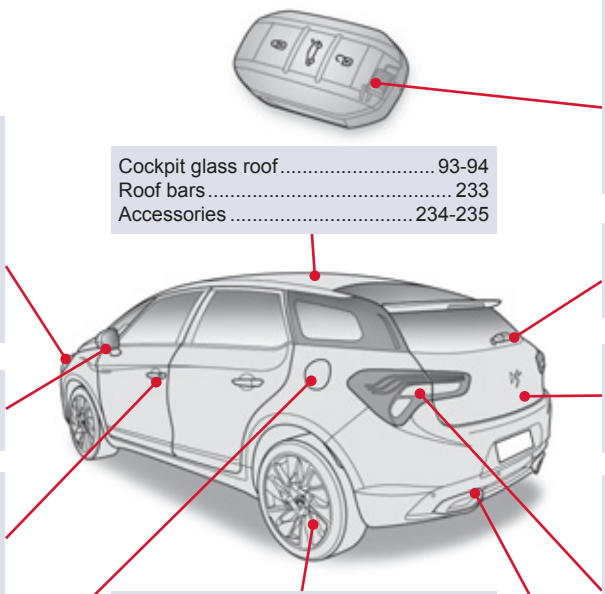

Instruments and controls (continued)

Starting/stopping 31-32
 Accessory position 33, 83
 Clock 74

Colour screen 265, 306-308
 Screen C 318, 338-339
 Hybrid power flows 40-41
 Hybrid consumption,
 eco-driving 47-49

Hazard warning lamps 184

Lighting controls 152-158
 Automatic headlamp dipping 157
 Direction indicators 184

Hybrid4 mode selector 35-37

eMyWay controls 263

Electric parking
 brake 126-133

Head-up display 140-141

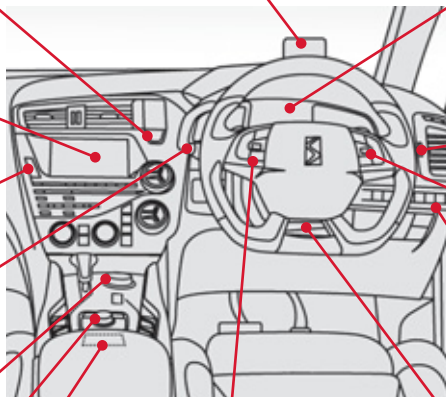

Instrument panels, screens 58, 68-73
 - check / service indicator /
 trip distance recorder
 - lighting dimmer / black panel
 Warning lamps 59-67
 Ready lamp 35
 Energy consumption /
 generation meter 38-39
 Indicators 68-71

Wiper controls 163-166
 Trip computer 76-77

Steering mounted audio
 system controls 264, 317

Switch panels, switches 14
 Opening the fuel filler flap 95
 Opening the boot 88
 Alarm 89-90
 Eco OFF 46
 Headlamp height adjustment 160

Memorising speeds 142
 Speed limiter 143-144
 Cruise control 145-146

Steering wheel adjustment 109
 Horn 185

Interior

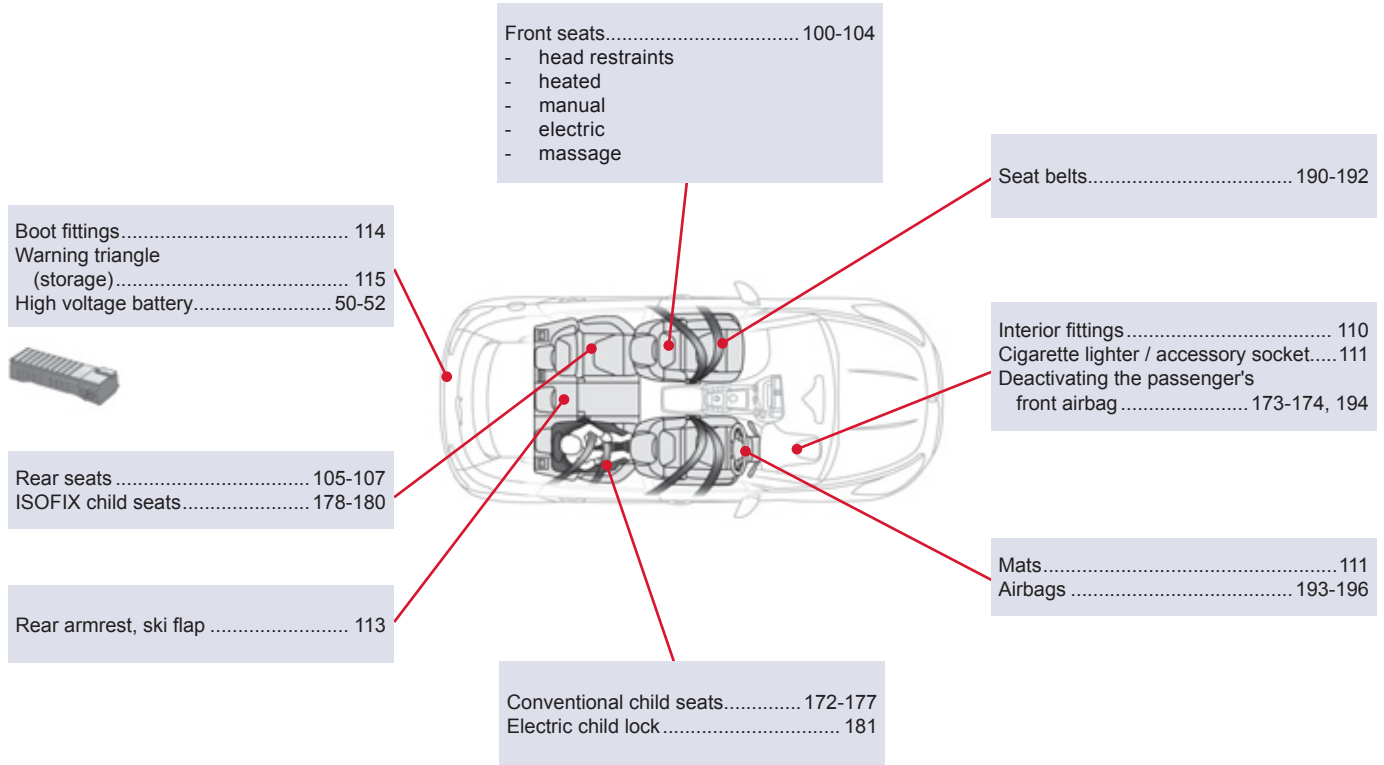

Maintenance - Technical data

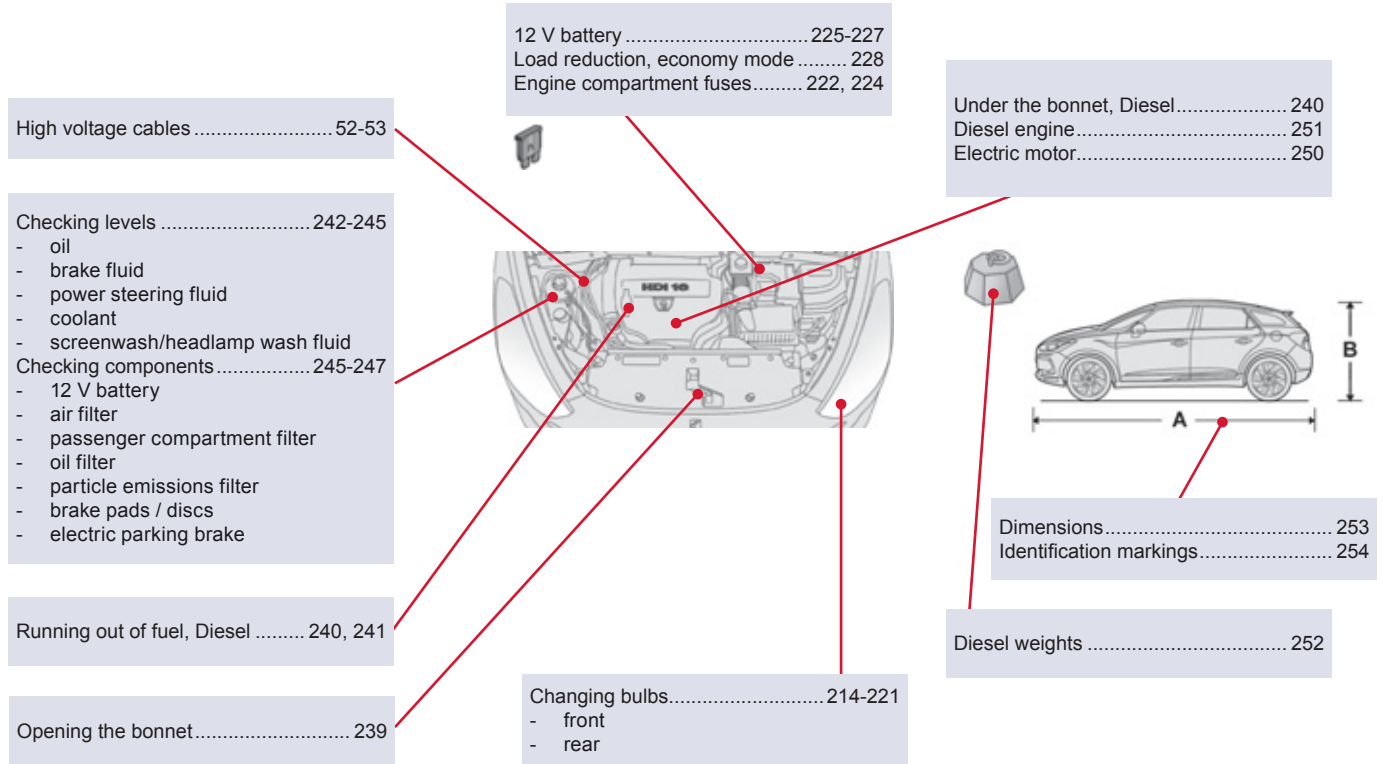







This handbook describes all of the equipment available in the whole range.

Your vehicle will be fitted with some of this equipment described in this document, depending on its trim level, version and the specification for the country in which it is sold.

The descriptions and illustrations are given without any obligation. Automobiles CITROËN reserves the right to modify the technical specifications, equipment and accessories without having to update this edition of the handbook.

This document is an integral part of your vehicle. It should be passed on to the new user in the event of sale or transfer.

Automobiles CITROËN declares, by application of the provisions of the European regulation (Directive 2000/53) relating to End of Life Vehicles, that it achieves the objectives set by this regulation and that recycled materials are used in the manufacture of the products that it sells.

Reproduction or translation of all or part of this handbook is prohibited without written authorisation from Automobiles CITROËN.

For any work on your vehicle, use a qualified workshop that has the technical information, competence and equipment required, which a CITROËN dealer is able to provide.

Printed in the EU
Anglais

02-13

Automobiles CITROËN

Siège social : 6 rue Fructidor - 75835 Paris Cedex 17 - France

TÉL. : +33 (0) 1 58 79 79 79 - www.citroën.fr

S.A. au capital de 159 000 000 € - R.C.S. Paris 642 050 199 - Siret 642 050 199 00990 - APE 741 J

4Dconcept
Diadeis
Edipro



13DS5HY030
Anglais