

Czech Technical University in Prague
Faculty of Electrical Engineering

Doctoral Thesis

September 2016

Ing. Radoslav Sokol

Czech Technical University in Prague
Faculty of Electrical Engineering
Department of Economics, Management and Humanities

**METHODS FOR BALANCING
ELECTRICITY GENERATION FROM
RENEWABLES ON THE ELECTRICITY
MARKETS**

Doctoral Thesis

Ing. Radoslav Sokol

Prague, September 2016

Ph.D. Programme: Electrical Engineering and Information Technology
Branch of study: Business Management and Economics

Supervisor: Doc. Ing. Jaromír Vastl, CSc.

I. Acknowledgment

The author would like to express his gratitude to his supervisor, Doc. Ing. Jaromír Vastl, CSc. for valuable comments and contributions. Also I would like to give thanks to my family for their tolerance during my work.

II. Declaration

I declare that all parts of this thesis have been written by myself and that I have only used references explicitly referred to in the text.

III. Abstract

Power generation mix of each country depends mainly on the availability of usable resources in its territory or the possibility of importing them. In connection with the fulfilment of ambitious objectives to be reached by 2020 power generation mix is changing rapidly and is heading toward low carbon electricity generation footprint. Power generation mix in individual countries is more and more affected by their geographical location and its potential for utilization of renewables. In the beginning of year 2016 OTC electricity prices for 2017 base-load delivery in Germany were attacking 20 EUR level while half a year ago it was traded for 30 EUR. [37] Subsidized renewables caused price curve distortion resulting in conventional hard coal and lignite power plants that accounted in 2015 for 42% of total electricity generation, to operate close to their variable costs. Share of Germany's electricity generation from renewables reached in 2015 30% and still new projects are planned or already under construction. [13] Low prices are not only affecting electricity markets where renewables are installed but also adjacent electricity markets in the neighbouring countries that are well-interconnected. With increasing renewable power capacity serious problems are experienced in the whole meshed central European network that may eventually lead to blackout situations. For electricity market participants with renewables in their generation portfolio is crucial to have all possible means to stay balanced. Interconnected electricity markets with high liquidity covering every day 24 hours and offering short-term products that can be traded as close as possible to delivery have to be on place. In case of missing trading platform, low liquidity or long time lag between delivery and product trading deadline, market participants are unable to balance themselves and are consequently exposed to balancing costs that can account for big part of total costs endangering profitability. In any case balance responsible parties have to do everything to be balanced. In my thesis I am testing possibility of using neural networks to improve generation forecast for wind farm from three independent meteorological data providers. Results from test scenarios which differ in various combinations of inputs were analysed and compared with regard to the most important indicators from the perspective of the wind farm owner. Balancing cost saving criterion is the most important measure to evaluate whether obtained results are better compared to the results of the most accurate meteorological data provider. Test scenarios for both day ahead and intraday time frame have been tested. Test period of six months proved that cost savings for balancing deviations can be achieved.

Keywords:

Neural networks, renewables, meteorological forecast, electricity markets

IV. Abstrakt

Energetický mix každé země závisí především na dostupnosti využitelných zdrojů nebo možnosti tyto zdroje dovézt. V souladu s naplněním ambiciózních cílů pro snížení emisí o 20% (vzhledem k úrovni vypouštěných emisí z roku 1990) do konce roku 2020 se energetický mix rapidně mění a trend se ubírá směrem k výrobě elektřiny s nízkou uhlíkovou stopou. Energetický mix v jednotlivých zemích je čím dál víc ovlivněn jejich geografickou polohou a tím i jejich potenciálem pro využití obnovitelných zdrojů. OTC ceny kontraktu dodávky pásma elektřiny pro rok 2017 atakovali na začátku roku 2016 hranici 20 EUR, zatímco v půlce roku 2015 se ten samý kontrakt obchodoval za 30 EUR. [37] Dotované obnovitelné zdroje zapříčinily pokřivení cenové křivky, což má za důsledek, že klasické hnědouhelné elektrárny, které se v roce 2015 podílely z 42% na výrobě elektřiny, vyrábějí blízko svých variabilních nákladů. Podíl výroby elektřiny z obnovitelných zdrojů v Německu dosáhl 30% v roce 2015 a další nové kapacity jsou ve výstavbě nebo jsou plánovány. Velké instalované kapacity v obnovitelných zdrojích neovlivňují jen ceny elektřiny v zemi, ve které jsou instalovány, ale přímo ovlivňují i ceny elektřiny v sousedních zemích, které jsou spolu propojeny přeshraničním vedením, kde větší přenosová kapacita mezi těmito trhy znamená větší dopad na ceny sousedního trhu. S rostoucí instalovanou výrobní kapacitou obnovitelných zdrojů jsou bohužel spojené i vážné problémy s bezpečností přenosových soustav v celé střední Evropě, což může vést v krajním případě k selhání přenosové soustavy a přerušení dodávek elektřiny. Pro účastníky trhu s elektřinou, kteří mají ve svém výrobním portfoliu obnovitelné zdroje, je důležité mít co nejvíce dostupných prostředků pro vybalancování jejich portfolia. Propojené trhy s elektřinou s vysokou likviditou, pokrývající 24 hodin v každém dni a nabízející obchodní produkty obchodovatelné co nejbližší času začátku dodávky jsou nezbytností, aby účastník trhu s elektřinou mohl být vybalancován. V opačném případě, kdy se obchodníkovi nedostává likvidní obchodní platformy s nevyhovujícími obchodními produkty, nemohou vybalancovat své obchodní diagramy a tím jsou přímo vystaveni platbě za způsobenou odchylku, což může představovat nemalé náklady, které mohou přímo ohrožovat profitabilitu portfolia. V mé disertační práci testuji možnost použití neuronových sítí pro zlepšení predikce výroby elektřiny z větrné farmy za použití vstupů od tří nezávislých poskytovatelů meteorologických dat. Výsledky různých testovaných scénářů, které se liší v kombinacích použitých vstupů, byly analyzovány a porovnány jejich nejdůležitější statistické indikátory z hlediska provozovatele větrné farmy. Kritickým kritériem pro vyhodnocení úspěšnosti jednotlivých neuronových sítí a tedy i odpovídajících testovaných scénářů byla úspora bilančních nákladů oproti výsledkům nejpřesnějšího poskytovatele meteorologických dat. Byly testovány scénáře pro použití modelu jak na denním tak intradenním trh s elektřinou. Perioda o délce trvání šesti měsíců byla použita pro vyhodnocení, může-li být dosaženo úspory nákladů na odchylku.

Klíčová slova:

Neuronové sítě, obnovitelné zdroje, meteorologická predikce, trhy s elektřinou

V. Abbreviations

AAC	Already Allocated Capacity - Total amount of allocated transmission rights, whether they are capacity or exchange programmes depending on the allocation method
AMF	Available Maximum Flow
AnS	Ancillary services - Services necessary to support the transmission of electric power from seller to purchaser given the obligations of control areas and transmitting utilities within those control areas to maintain reliable operations of the interconnected transmission system
ATC	Available Transfer Capacity - Part of NTC that remains available after each phase of the allocation procedure for further commercial activity. ATC is given by the following equation: $ATC = NTC - AAC$
BH	Business hour/-s – Standardized time interval that is being traded on the ID and DAM.
CMO	Common merit order
DAM	Day-ahead electricity market/-s - Forward market where electricity quantities and market clearing prices are calculated individually for each hour of the day on the basis of participant bids for energy sales and purchases.
DB	Database is an organized collection of data. It is the collection of schemas, tables, queries, reports, views, and other objects. The data are typically organized to model aspects of reality in a way that supports processes requiring information, such as modelling the availability of rooms in hotels in a way that supports finding a hotel with vacancies.
ENTSOE	The European Network of Transmission System Operators for Electricity - represents 42 electricity transmission system operators (TSOs) from 35 countries across Europe. ENTSO-E was established and given legal mandates by the EU's Third Legislative Package for the Internal Energy Market in 2009, which aims at further liberalising the gas and electricity markets in the EU. ENTSO-E members share the objective of setting up the internal energy market and ensuring its optimal functioning, and of supporting the ambitious European energy and climate agenda. One of the

important issues on today's agenda is the integration of a high degree of Renewables in Europe's energy system, the development of consecutive flexibility, and a much more customer centric approach than in the past.

- ID** Intra-day electricity market/-s - Forward market where electricity is traded after the DAM. Contracted energy positions are close to their expected physical energy position. Market participants fine tune their positions in the light of new information about their own production and consumption positions and overall system position.
- MLP** Multi-layer perceptron/-s - A network composed of more than one layer of neurons, with some or all of the outputs of each layer connected to one or more of the inputs of another layer. The first layer is called the input layer, the last one is the output layer, and in between there may be one or more hidden layers.
- NN** Neural network/-s - A neural network consists of an interconnected group of artificial neurons, and it processes information using a connectionist approach to computation.
- NTC** Net Transfer Capacity - (intended for commercial purposes) represents the difference between the total transfer capacity and the transmission reliability margin
- P&L** Profit and Loss Statement - A profit and loss statement is a financial statement that summarizes the revenues, costs and expenses incurred during a specific period of time.
- PCG** Project Coordination Group – Group of experts with participants from EC, Regulators, ETSO, Europex, Eurelectric and EFET, involving Member States' representatives as appropriate, with the tasks of developing a practical and achievable model to harmonise interregional and then EU-wide coordinated congestion management, and of proposing a roadmap with concrete measures and a detailed timeframe, taking into account progress achieved in the ERGEG ERI. This Project Coordination Group (PCG) is chaired by the European Energy Regulators and has been meeting regularly to develop an EU-wide target model for the integration of the regional electricity markets. The target model covers forward, day-ahead, intraday and balancing markets as well as capacity calculation and governance issues.

RE	Renewable energy is generally defined as energy that is collected from resources which are naturally replenished on a human timescale, such as sunlight, wind, rain, tides, waves, and geothermal heat. [2] Renewable energy often provides energy in four important areas: electricity generation, air and water heating/cooling, transportation, and rural (off-grid) energy services.
SoS	Security of Supply - “security of electricity supply means the ability of an electricity system to supply final customers with electricity”. European energy regulators further specified this definition: “Security of supply means that customers have access to electricity at the time they need it with the defined quality and at a transparent and cost-oriented price.” [38]
TRM	Transmission Reliability Margin - represents a portion of total transfer capacity that must be ensured by the system operator to cover the possible outage of the largest generator in the control area, due to angle or voltage stability problems etc.
TTC	Total Transfer Capacity - represents the maximum exchange of active power between two neighbouring electric power systems that is compatible with operational security standards applied in each electric power system.

VI. Content

I.	Acknowledgment.....	3
II.	Declaration.....	4
III.	Abstract.....	5
IV.	Abstrakt.....	6
V.	Abbreviations.....	8
VI.	Content.....	11
VII.	Tables.....	14
VIII.	Images.....	15
1	Introduction.....	18
1.1	Hypotheses.....	20
1.1.1	Hypotheses 1.....	20
1.1.2	Hypotheses 2.....	20
1.1.3	Hypotheses 3.....	20
1.1.4	Hypotheses 4.....	21
1.2	Scientific Methodology.....	21
2	Electricity Markets in the EU and Renewable Energy Overview.....	23
2.1	Intraday Electricity Market.....	24
2.2	Pan European Intraday Target Model.....	27
2.3	Intraday in the CEE Region.....	29
2.4	Flow-based Capacity Calculation.....	31
2.5	Transmission Capacities.....	34
2.6	Day-ahead Market.....	35
2.6.1	Tradable Contracts.....	36
2.7	Day-ahead Market Coupling.....	37
2.7.1	How Wind Power Influences Prices on the Day-ahead Market.....	38
2.8	Balancing Market.....	38

2.9	Renewable Energy.....	40
2.9.1	Wind Power in Europe.....	40
2.9.2	Wind Power Installations Facts	41
2.9.3	Solar Power in Europe	44
3	Current Approaches and Working Methods.....	46
3.1	State of the Art and Methodology Background	46
3.1.1	Quantile Regression	48
3.1.2	Neural Networks	48
3.1.2.1	Multi-layer Perceptrons.....	51
3.1.2.2	Recurrent Networks	51
3.1.2.3	Back Propagation (Learning as gradient descent).....	53
3.1.2.4	Variations on Backpropagation.....	56
3.1.2.5	Heuristic Methods	57
3.1.2.6	Standard Numerical Optimization Methods	57
3.1.2.7	Generalization and the Choice of Topology	57
3.1.2.8	Train and Test Data Set.....	62
3.1.2.9	Learning Rate	63
3.1.2.10	Slope of the Activation Function	65
3.1.2.11	Activation Functions	65
3.2	Methodology and Model Design.....	67
3.2.1	Improving forecast of wind power generation using model based on neural network	67
3.2.2	Balancing Residual Positions on Intraday Electricity Markets.....	68
4	Case Study	70
4.1	Software Solution.....	70
4.1.1	Application Core.....	70
4.1.2	Data Storage.....	70
4.1.3	Neural Network Framework	71
4.2	P&L Photovoltaic Power Plant Optimization on the Electricity Markets.....	71

4.3	Wind Forecasting Model Based on Neural Network for Trading on DAM.....	77
4.3.1	Training and Test Data Set.....	77
4.3.1.1	Generation Data	78
4.3.1.2	Meteorological Data.....	78
4.3.1.3	Inputs for the NN	78
4.3.1.4	Output of the NN.....	80
4.3.2	Scenarios Design.....	81
4.4	How to Improve DAM Model for ID Trading	85
5	Evaluation of Set Objectives and Proposed Hypotheses	91
5.1	Evaluation of Hypotheses 1.....	91
5.2	Evaluation of Hypotheses 2.....	91
5.3	Evaluation of Hypotheses 3.....	92
5.4	Evaluation of Hypotheses 4.....	92
6	Conclusions	94
6.1	Possibilities for Further Research	96
7	References	97
8	Publications	103

VII. Tables

Tab. 2.1	Roadmap for establishing of pan-european intraday market [47]	29
Tab. 2.2	Time lines for one ID session (H is the first hour of ID time interval) [48]	30
Tab. 2.3	Power installed in Europe in years 2014 and 2015 [4]	44
Tab. 3.1	Transfer functions [9]	67
Tab. 4.1	Deviation scenarios	73
Tab. 4.2	Delta of electricity generation to be traded in hour H - 0	74
Tab. 4.3	Results of neural networks scenarios	77
Tab. 4.4	Input combinations for neural network test scenarios	79
Tab. 4.5	Impact of additional real generation inputs on sum of deviations	87

VIII. Images

Fig. 2.1	Cross-border trading between France and Germany based on FITS [20]	26
Fig. 2.2	Volumes traded on intraday markets [TWh] [16].....	27
Fig. 2.3	Shared order book functionality [21].....	28
Fig. 2.4	Flow-based and ATC-based domain [22].....	32
Fig. 2.5	Cross-border capacity terminology for trading purposes [23].....	34
Fig. 2.6	Implicit auction principle between two markets [24]	35
Fig. 2.7	Day-ahead volumes [TWh] [16]	36
Fig. 2.8	EU power mix in 2000 and 2015 [4]	43
Fig. 2.9	Global cumulative installed PV capacity [GWp] [11].....	45
Fig. 3.1	Schematic drawing of biological neurons [9]	50
Fig. 3.2	Example of multi-layer neural network [9].....	51
Fig. 3.3	Delay Block [9].....	52
Fig. 3.4	Integrator [9]	52
Fig. 3.5	Recurrent Network [9]	53
Fig. 3.6	Overfitted function (black) and network with the „right“ generalization (grey) [own] 58	
Fig. 3.7	The average learning error rate and the average test error rate as a function of the number of hidden units. [10]	60
Fig. 3.8	Illustration of Early Stopping [9].....	61
Fig. 3.9	Efect of the learning set size on the error rate. The average error rate and the average test error rate as a function of the number of learning samples. [10].....	63
Fig. 3.10	Typical graph of the error development in time [10].....	64
Fig. 3.11	Various activation functions [10].....	66
Fig. 4.1	Nonlinear quantile regression for $\tau \in \langle 0.05; 0.95 \rangle$ with 0.05 step.....	72
Fig. 4.2	Electricity balancing strategy for deviations scenario No. 1	75
Fig. 4.3	Electricity balancing strategy for deviations scenario No. 2	75
Fig. 4.4	Electricity balancing strategy for deviations scenario No. 3	75

Fig. 4.5	Electricity balancing strategy for deviations scenario No. 4	76
Fig. 4.6	Electricity balancing strategy for deviations scenario No. 5	76
Fig. 4.7	Correlation matrix for all available inputs	80
Fig. 4.8	Histogram of deviations data from No. 1 provider	83
Fig. 4.9	Histogram of deviations data from No. 2 provider	84
Fig. 4.10	Histogram of deviations data from No. 3 provider	85
Fig. 4.11	Model output with latest known measured generation as an additional input.....	86
Fig. 4.12	Forecast from 1st meteorological data provider	87
Fig. 4.13	Quantile regression line – deviations from real generation	89
Fig. 4.14	Quantile regression line – deviations from real generation – no additional inputs	90
Fig. 4.15	Deviation between 2nd provider and neural network output.....	90

1 Introduction

In this thesis I primarily focus on the day-ahead wind farm generation forecast from different meteorological providers and test if by using neural networks accuracy of the forecast can be improved. Usage of NN for testing if we can improve our forecast accuracy makes sense for the fact that they require large diversity of training data which we have in our case in order to capture the underlying structure that allows it to generalize to new cases.

Every single wind farm is unique because of its specific location where it was built and meteorological data providers may have accurate wind power forecasting tools but they usually use generally known wind-turbine power curve to estimate the generation from wind speed. In other words the very specific aerodynamics of each wind farm is not taken into account and this is where data providers might create errors in the power generation forecast. That gives us a space to find out if their model shows some systematic error in some BH or just for some specific wind speed ranges or perhaps for another combination of available forecasted meteorological data.

We might improve power output forecast by deriving aerodynamic models for the concrete wind farm but this will surely be very complex, difficult and time consuming task which can be above all very costly. In the end this does not guarantee us better accuracy. NN could offer here a solution how to improve the accuracy without knowing anything concrete about the exact location of individual turbines of any wind farm. The only information we need is a very good set of historical data that would train our NN to improve our prediction model.

On the market are a few meteorological data providers that can supply wind farm owners with either various weather forecast data that need to be anyhow „translated“ into wind farm generation in MW or directly with wind farm generation output or eventually with both data sets. Large wind farms cannot rely only on one data provider whose forecast could worsen over some time so that a few of them are chosen and the forecasts are back tested against the historical generation data and the best provider with the least error prediction is chosen.

Wind farms in addition to the forecasted data have their own meteorologist who validates the data so that he/she has the last chance to change possible inconsistencies in the data. It is usually the job of the meteorologist to anticipate and take into account the impact of freezing rain on wind turbines that can put offline the whole farm even in very windy conditions. This can be crucial in case that your forecast providers say that the wind farm will run on 100% of its installed capacity and due to the frozen rain on the blades the wind farm has to be put offline because of the safety reasons.

Even if we could reduce the error by just one decimal it could be considered as success because of the transmission system deviation prices that penalize deviations between scheduled or traded volume on the market and the real generation which will be discussed later in more details.

Saving costs for deviations is important especially when the already established feed-in tariffs for green electricity generation are under huge scrutiny in almost every country in Europe where generous feed-in-tariffs were set to meet the EU target of 20% cut in greenhouse gas emissions by 2020 (from 1990 levels). [39] Now the burden of ever-increasing bills for electricity is affecting not only the competitiveness of the industry in the whole Europe but most importantly it has impact on the wallets of people or rather voters which creates lots of populist proposals to cut as much as possible feed-in tariffs to attract most voters. On the other hand it directly compromises return on investment of the already built projects that calculated with some yearly income based on the conditions that were set in the past. The pressure will result in more or less significant changes in the feed-in tariffs so that the income from these projects will tighten and it will be utmost important not to lose any more money on deviations caused by the forecast inaccuracy. For instance Germany, a country with a strong economy will cast aside feed-in-tariffs and introduce new system of auctions as a support for renewable energy investment starting from January 2017. [40]

Primary goal of my thesis is to **improve forecast of wind power generation using model based on neural network**. For this purpose neural network will be designed and trained on various meteorological data and tested that it can generate better generation forecast compared to the most accurate meteorological data provider. The neural network model will be tested in the whole scale of generation forecast levels for the period of six months. For the wind farm better precision means lower sum of deviations which means balancing cost savings. Robust neural network model should be possible to use for any wind farm regardless of its installed capacity or location.

Other partial goals:

- Provide a description of electricity markets in the EU and their future development in relation to renewables including overview of current state of wind and solar power industry in Europe.
- Show on a model example that balance responsible party with renewables in its portfolio is not always motivated to be balance at any cost.

1.1 Hypotheses

In line with the targets described above I set the hypotheses that are further defined which will allow me to meet these targets.

1.1.1 Hypotheses 1

Balance responsible parties with renewables in their generation portfolio are not primarily motivated to be balanced.

Under this hypothesis I will setup a model to demonstrate that balance responsible parties rather than minimizing their deviations from their schedules are minimizing their financial losses where both approaches do not necessarily lead to the same solution. Analysis of different situations is performed to demonstrate market participants behaviour based on various electricity market prices, expected deviation prices and probability of production of the renewable asset. Model is based on historical generation data from PV power plant. I will try to demonstrate that we can setup a model that maximises P&L for the market participant based only on statistical analysis without having weather or rather irradiation forecast.

1.1.2 Hypotheses 2

Forecasting model based on neural network gives better results compared to the results of the most accurate meteorological data provider that serves us as an input into our neural network. Comparison is performed on the basis of the „*sum of absolute differences*“ criterion that sums up generation deviations from the forecasted values.

Under this hypothesis robust neural network model will be programmed and subsequently trained and tested with set of data that has been collected. I will compare distribution of results of individual test scenarios. Scenarios will be evaluated on the basis of „*sum of absolute differences*“ that has the biggest impact on the deviation balancing costs.

1.1.3 Hypotheses 3

Forecasting model based on neural network gives best results if all available inputs are used.

Under this hypothesis correlation analysis of all available input data will be performed. Furthermore results of different test scenarios that will vary in number and combinations of available meteorological inputs will be compared. I will try to find optimal neural network with such combination of meteorological data inputs that gives satisfactory results and does not contain any unnecessary inputs.

1.1.4 Hypotheses 4

Additional input in form of recent real generation data will improve „*sum of absolute differences*“ criterion.

While hypotheses 2 and 3 were focused on improving the generation forecast for trading on DAM here we focus on improving our forecast for ID market trading. The difference here is that on ID market we are trading close to delivery time and we have recent data on generation.

1.2 Scientific Methodology

First step was a review of all relevant literature and professional articles in order to find the most suitable methods to analyze and solve researched topic. Methods that are used to solve and evaluate achieved results are objective and transparent. Methodologies are fully explained and studies can be easily repeatable.

Further problems were defined, search of literature was conducted, that can be considered as an exploratory research that looks for explanations of the nature of certain relationships and consequently hypotheses were formed. Further hypothesis were tested to provide an understanding that of the relationships that exist between our variables and conclusions were consequently drawn. [35], [34]

The main methodological approach of my research is the inductive method. It helps to formulate general rules, principles and laws. Ultimately allows the use of available information to develop scientific theories - inductive conclusions go beyond the information obtained in the original data. [18]

In this research mainly quantitative research was applied. Quantitative research is to determine relationship between inputs and outputs. Quantitative research is ‘Explaining phenomena by collecting numerical data that are analyzed using mathematically based methods (in particular statistics)’. [36]

For my research four basic hypothesis have been formulated. All aspects of the study were carefully designed before data was collected. Sufficiently large set of data for calculation was collected and analyzed. Data has been arranged in tables in a structured database. The output model is used to predict future results. As a research tools numerous computer software has been used. Results are based on test data from four months that represent quite large sample sizes that is representative of the population. Based on the results obtained from the model conclusions that accept or reject our hypotheses were drawn. [41], [42]

Descriptive statistics has been used to compare different test scenarios. Deductive procedures were used in drawing conclusions from set hypotheses. Data used in this study does not contain any subjective inputs.

2 Electricity Markets in the EU and Renewable Energy Overview

Power market liberalization in Europe has been an essential element to further market integration and development of energy trading across Europe. The completion of the Single European Market, the development of interconnections, the diversification of the generation mix, climate change and low-carbon future has been among the main challenges of market liberalization in Europe.

In most of the EU countries DAM has been launched already. The liquidity on this market increases with the higher percentage of renewables in the generation mix due to the unpredictability of generation output in the longer term horizon. Because of this most of electricity from renewables is traded on the DAM and ID. If the day-ahead forecast for generation from renewables proves to be inaccurate we still have a chance to balance our position on the ID if there is one. [43]

The disaster in Japan resulted in decision to shut all German nuclear plants by 2022 which together with binding EU-wide target to source 20% of their energy needs from renewables represents pressure not only on building of a new transmission capacities but also on functional electricity trading scheme for Europe. Main focus here is on intraday cross-border trading scheme rather than planning for new overhead transmission lines which is very hot topic at the moment.

The problem is caused by lack of grid investments which pushes neighbouring grids for balancing foreign energy caused by loop and parallel flows. The very common example of such situations is high PV or wind power generation in north of Germany which is routed through Poland and Czech Republic. These flows cause congestion on the interconnectors and endanger balance or stability in neighbouring countries. TSOs affected by these unwanted and unscheduled flows are forced to plan and build phase shifters across the borders which would make the German grid more unstable. That would also mean to curb building of a new wind farms in Germany or shut down in certain situations some of the existing ones.

This situation impacts not only neighbouring TSOs but also market participants who complain of having no cross-border capacity which is cut because of loop flows. Despite grid upgrades are already planned it's possible that the ongoing process of building of a new wind power plants exceeds the new overhead lines capacity.

The impact of increasing installations in renewables causes shift in volumes traded as longer term forwards or futures to shorter term products traded on day ahead and intraday markets which is caused by balancing rapid changes of renewable generation.

2.1 Intraday Electricity Market

Easiest and cheapest way of balancing ever changing generation from renewables is well functioning intraday electricity market but available local demand or supply are often insufficient to do the job. In most of the European countries we can find all different kinds of platforms for trading electricity on intraday basis which are more or less user-friendly. Unfortunately regulations, trading rules and deadlines in the whole trading process are not harmonised. Smaller markets like the one in the Czech Republic or Slovakia lack liquidity and market participants have small chance to close their open positions. In this specific case market participants have a chance to bid for the cross-border capacities from/to Germany to access liquid intraday market if they want to trade for „market prices“ but this is connected with high expenses for being registered on both markets but not every power producer can afford it.

Efficient solution for intraday cross-border trading is to interconnect local markets with available cross-border capacities. For all traders would be most desirable to have only one platform with common rules and tradable products for all the interconnected markets. The envisioned target model is to allow the trader to see bids and offers from neighbouring markets up to maximum of available cross-border capacity allocated by TSOs for trading. Traders don't need to know if the electricity which is to be purchased/sold will be generated/consumed in his country or somewhere abroad if the transmission capacities allow this deal to be concluded. [44]

This concept to be approved and implemented needs general acceptance by all participating parties starting with TSOs, regulators, PXs, traders and all stakeholders. TSOs will be responsible for continuous update and recalculation of available cross-border capacities in a manner that no concluded deal between two parties causes breach of local security rules. Most important role in the whole project will play entity responsible for free cross-border capacity calculation. Let say that keeping traders order books won't be difficult task since this has been already implemented in many projects and no new particularly difficult functionalities will be needed. [43]

The core of the whole project will be the data which TSOs supply to the entity which will be responsible for calculation and allocation of cross-border capacities within the whole electricity market. We already had a chance to see that this is no easy task in implementation of a common CEE explicit capacity auction based on FBA method. The method was to give better results compared to the present NTC capacity allocation method but no better results were given to the market participants. [45] Some of the problems were caused by the data supplied by the TSOs describing the state of their grid which consists of thousands of different values and even one miscalculated value can cause that no cross-border deal can be concluded.

ID contribute to facilitate transition from conventional sources to renewables which need to be balanced on real-time basis due to the unpredictable nature of weather. Increasing the liquidity of the market place is a means to maximize social welfare.

Single liquid ID where market participants can balance their portfolios is prerequisite to a full utilization of renewable power sources and a solution for some problems experienced by TSOs with loop and parallel flows from neighbouring countries.

The most liquid and developed ID is in Germany and France that create one common market in case there is sufficient cross-border capacity that interconnects these two markets. In case of congestion on borders one single market splits into two separate markets. [20]

The most important facts characterizing the market are listed below:

- Continuous trading and price formation, 24 hours a day, 7 days a week, year-round
- Contracts can be traded until 30 minutes before the beginning of delivery
- Hourly and block contracts available for trading
- 15-minute contracts on German market allow highly flexible balancing of portfolio
- Cross-border trading between France and Germany – Flexible Intraday Trading Scheme (FITS)

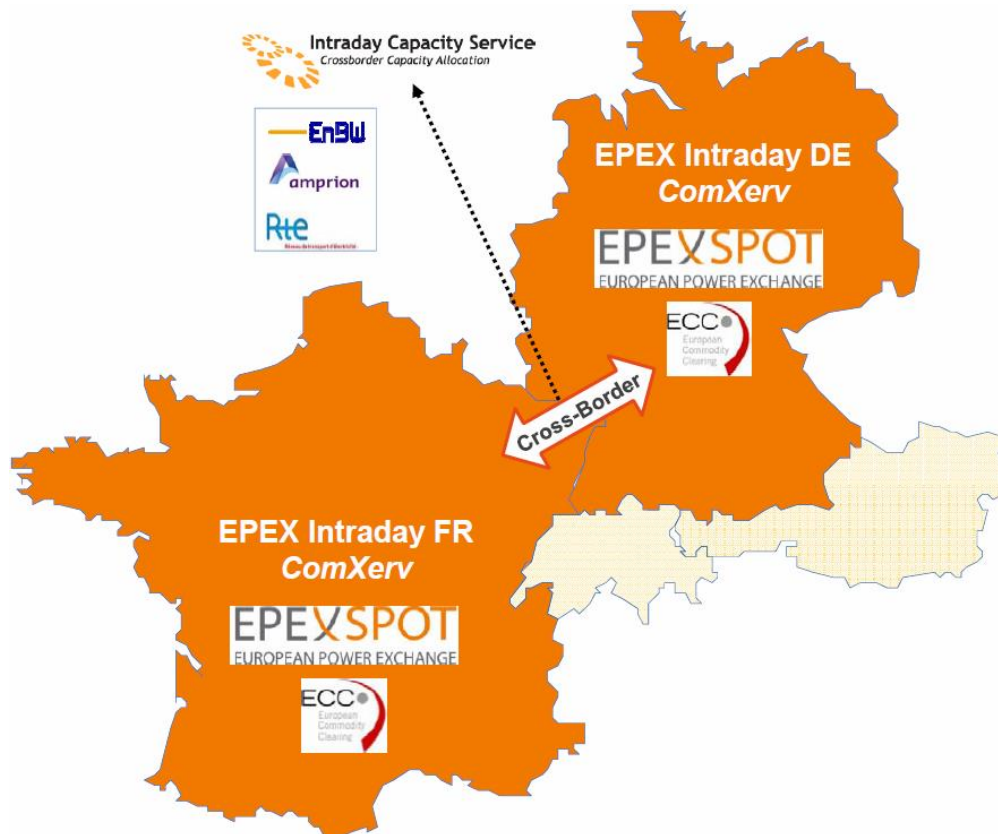

Fig. 2.1 Cross-border trading between France and Germany based on FITS [20]

In my opinion this project or the way how these two ID were connected is the right way to move forward in the process of electricity markets integration.

Common German and French ID market can be considered as an example of a well-functioning intraday market where Flexible Intraday Trading Scheme (FITS), which allows seamless implicit cross-border trading between the two countries, was implemented. Volumes traded in this market were partly increased due to the new renewables installations but mostly by cross-border trading between both markets.

Since the launch of FITS, introduced in December 2010, liquidity on the French Intraday Market has doubled. Over the year, cross-border trades accounted for 11.4 percent of traded volume on FITS. Growing demand for balancing renewables resulted in introduction of 15min products which contribute to facilitate the German energy transition. Liquidity on intraday markets is growing every year and we can see it in total traded volume which in 2009 reached together in France and Germany around 7 TWh, 11 TWh in 2010, 17 TWh in 2011, 18 TWh in 2012 and 23 TWh in 2013 where the traded volume is increasing year by year. [16], [19]

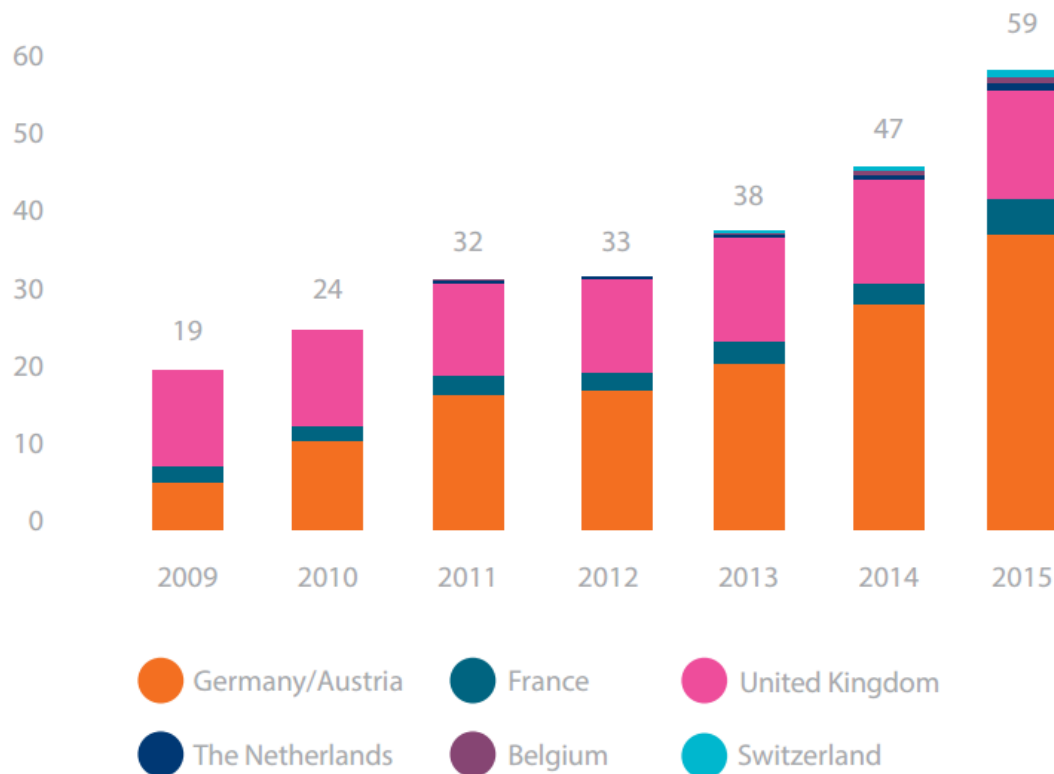

Fig. 2.2 Volumes traded on intraday markets [TWh] [16]

Looking at changes in 2012, trilateral market coupling between Czech Republic, Slovakia and Hungary has been started and Romania joined in 2014. As a software solution EPEX SPOT was chosen in Hungary which operates also intraday electricity market in Germany and France so we can expect possible transition towards this platform which is popular between traders because of its intuitive operability and flexible interface which is easy to personalize according to individual requirements. The decision to use this software is crucial on the way towards day-ahead and intraday target models of the European Commission.

2.2 Pan European Intraday Target Model

Target model for inter-regional cross-border capacity allocation in ID timeframe is implicit continuous allocation (continuous trading) where each area/TSO is represented by local order book on the lowest level with bids inside visible only to the market participants who have their long/short positions physically inside this area/TSO. Shared order book is above the structure of local order books which makes bids available between local order books subject to the availability of cross-border capacity which is calculated in the capacity management module. Input data into CMM are data from TSOs which requires coordinated cooperation of all participating TSOs. Target model has to allow block bids which would otherwise be concluded on bilateral basis. [46]

Market participants in each TSO would certainly welcome ID but there are still EU countries where there has been no ID implemented yet because of regulatory issues, problems with communication or rather interface setting between other systems that depend on the trading data. Also most of the intraday platforms were made only for the local electricity market where market participants from the neighboring TSOs have to bid for the cross-border capacity separately to access the neighboring market which makes the trading a bit difficult. If the local electricity market is not big enough it suffers from the lack of liquidity and market participants, after some time of low volumes traded there, stop watching it. The only way forward is to interconnect these illiquid markets and make it more attractive for the market participants.

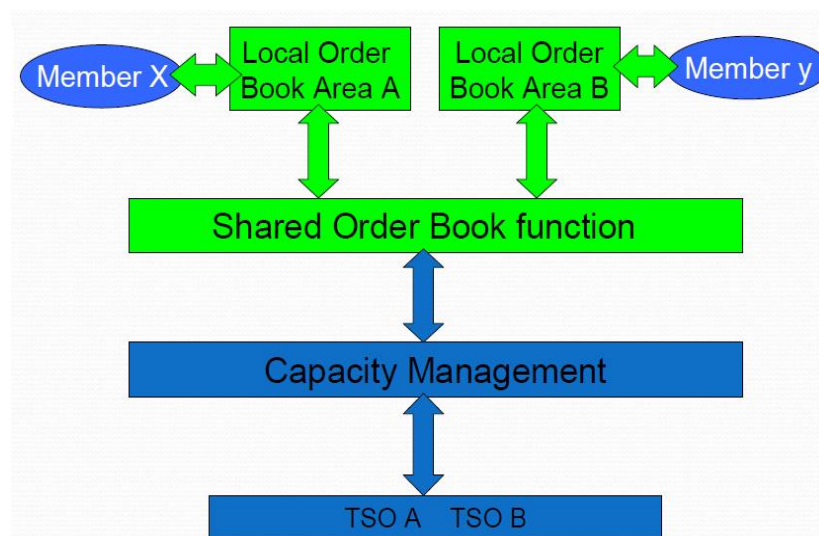

Fig. 2.3 Shared order book functionality [21]

For the continuous implicit auction cooperation of PXs is needed to allow their ID liquidity to match between them, irrespective of the exchange it was submitted to, but taking into account the available cross-border capacity. [20]

Design of “*Capacity Management Module*” shall ensure compatibility with the target model for cross border balancing (at the target, a multiborder mechanism should be put in place). Balancing would occur after intraday gate closure. [20]

	Description	2010	2011	2012	2013	2014	2015
Stage 1	Common principles + compatibility Requirements for ID trading	■					
Stage 2	Centralized capacity management and shared order book function	■	■				
Stage 3	ID National/Regional development*	■	■	■	■	■	
Stage 4	Stepwise implementation of TM			■	■	■	■
End	EU wide trade (target model)						■

*new development or copy/paste

Tab. 2.1 Roadmap for establishing of pan-european intraday market [47]

Together with the platform/software implementation of the pan-european intraday market legally binding guidelines and network codes has to be harmonised and approved amongst all participating TSOs, regulators etc.

2.3 Intraday in the CEE Region

As an example of existing local intraday markets with very poor liquidity in the CEE region are intraday markets in the Czech Republic, Slovakia and Poland. These markets exist separately with their own trading platforms, rules, deadlines, access certificates etc. Market participant to be able to trade on any of these markets has to register first and pay for the licence regardless of the traded volume. [43] Because of a really few “big” market participants on each local market the liquidity on the local markets suffers and market participants don’t even bother to spend their time trying to make some deals on intraday because of the prices which are not really market based. These three markets are connected with overhead transmission lines and market participants can bid for the intraday cross-border capacity to access the adjacent markets. The capacity is allocated on FCFS (first-come-first-served) principle with no payment for allocated capacity. The market is organized as right-with-obligation so that the market participant must use the acquired capacity. This is not entirely true because the capacity can be partially or fully netted with counter flows (capacity allocated in the opposite direction). In this case, as it was already mentioned, market participants are undergoing several risks throughout the whole process as it is the case with the day-ahead capacity allocation process. TSO CEPS acts as allocation office (transmission capacity allocator) for these borders [48]:

- CEPS–APG
- CEPS–SEPS
- CEPS–TENNET

- CEPS–50HzT
- PSEO–50HzT
- PSEO–CEPS
- PSEO–SEPS
- MAVIR–SEPS

The market is held seven days a week without any regards to any holiday within the related areas. The allocation is held in six sessions of four-hourly blocks. This model is slightly changed between TSO CEPS and TSO SEPS where 24 sessions has been introduced which is discusses in the next chapter. This is being understood as next step towards the single European market.

The intraday evaluation algorithm consists of two steps. In the first step, bids are assessed with respect to the current grid condition using flow-based mechanism. In the second step, the preliminary accepted bids are compared with capacity limits on technical / commercial borders and bids exceeding such limitations are rejected. The evaluation of bids is performed continuously so that each bid is evaluated immediately after receiving by the allocation office. [48]

As it was already mentioned, ID capacity allocation is performed in multiple auctions for time intervals inside the day D (one auction for one continuous time-interval). The nomination process is applied for the same time intervals defined. In the Tab.2 below you can see time lines for each intraday session.

Process	Start Time	Closing Time	Responsibility
Publication of final ID OC (<i>Note: OC updates are continuously available.</i>)		H – 2:30	TCA
Bids submitting for ID session	H – 6:00	H – 2:30	ITRs
Publishing of ID allocation results	H – 2:28		TCA
Publishing of ID capacity rights	H – 2:25		TCA
ID nominations entering	According to local rules (no later than H – 2:20)	H – 1:30	ITRs
Confirmation of final nominations		By H – 0:45	TSOs

Tab. 2.2 Time lines for one ID session (H is the first hour of ID time interval) [48]

The ID evaluation process is executed by the auction office every time new bid is submitted by the market participant. All not yet evaluated bids are subject of the evaluation, considering the already accepted bids. The algorithm itself is described in the next chapters. Results are available immediately after each individual evaluation.

As an interim step towards target model, CEPS and SEPS decided to introduce enhanced intraday concept (1-hour Intraday) which should provide market participants with more flexibility as to when cross-border transmission capacity can be obtained and fully matched. This enhanced intraday concept has been put into operation in April 2012. The difference between the present state (4-hour Intraday) and the enhanced Intraday is not only in length of time intervals for which traders can submit their bids but also in the process of evaluation and publishing of allocation results. For 4-hour session model gate opens 6 hours and closes 1.5 hour before the start of the session. For 1-hour session model the gate opens 18 hours and closes 1.5 hour before the start of the session which in this case corresponds to one business-hour. In both cases market participants are obliged to use all acquired capacity.

For the flow-based evaluation firstly common merit order list of the not yet evaluated bids is created based on First-Come-First-Served (FCFS) principle. Bids are evaluated one by one in the order in which they have been received by the system. Each transaction is assessed in terms of its effect on each border up to the remaining available capacity. The available capacities are determined on the basis of specified capacity limit values on borders (using the PTDF matrix) and DACF forecast models. Each bid is distributed to individual physical borders using the calculated distribution coefficients (PTDFs). The effect of individual transactions is thus simulated step by step, and the resulting model flows are added to the flows in the predictive DACF models created in $D - 1$. The computing system continuously compares physical flows on borders with forecasts obtained from the DACF model. If the deviation of these values exceeds a specified insensitivity threshold, the system cancels all bids concerning the hours for which the threshold was exceeded. Netting level applied within the allocation algorithm will be configurable (considering the risk of the non-fulfilling of the rights-with-obligation rule). The initial value will be 0 %. [48]

In NTC-based evaluation, preliminary accepted bids are compared with capacity limits (ATC) on technical/commercial borders and bids exceeding such limitations are rejected. After accepting of new bid the actual remaining ATC is recomputed for considering of all already accepted bids.

2.4 Flow-based Capacity Calculation

On most of the commercial borders, transmission capacity available for intraday is calculated as a capacity which was not used/nominated by the market participant on $D-1$ and

D-2 basis. This is not the ideal solution because commercial and real flows can differ substantially. Capacity available for intraday trading should rather reflect real flows than commercial flows because of the already mentioned differences between real and commercial flows. Flow-based method should reflect real flows and it should replace the obsolete NTC method for intraday capacity allocation. [22]

The main difference between NTC-based and flow-based allocation is that NTC represents only subset of capacity available for the purpose of trading. None of the method can violate SoS domain which defines all possible combinations of all flows in all possible directions without violating any technical and security limits. Flow-based method should correspond to the SoS domain while ATC domain is just part of the SoS domain. When TSOs provide ATC constraints, they have to make a choice on how to split the capacity among their borders (A to B and A to C) as you can see in the Fig. 2.4. That does not necessarily mean that the ATC domain is chosen according to the current market needs/situation. The market itself should define how to split the capacity as long as it does not violate SoS domain.

SoS domain in the Fig. 2.4 below is inside the blue bounded polygon while ATC-domain is inside the green bounded rectangle. No part of such defined rectangle can be outside the polygon.

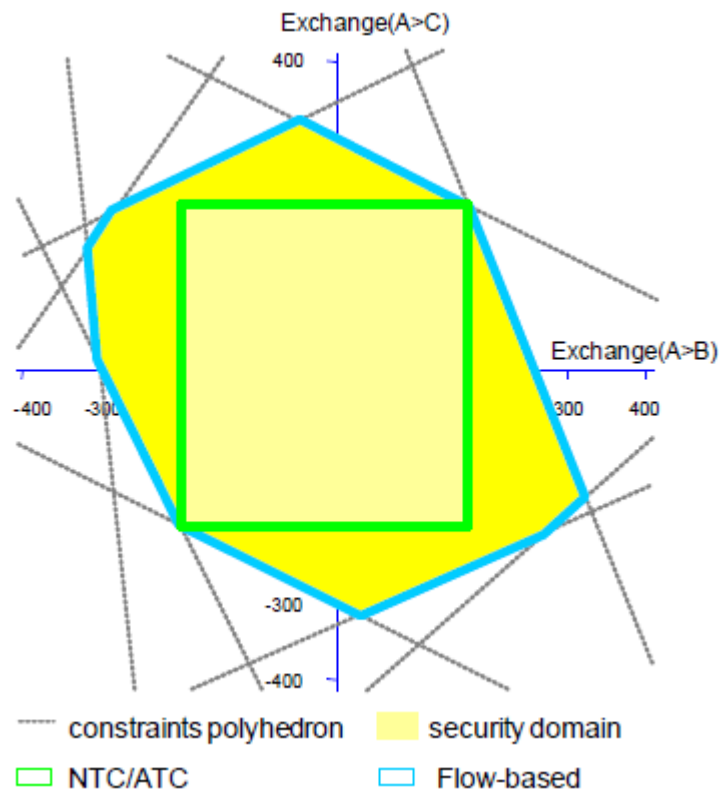

Fig. 2.4 Flow-based and ATC-based domain [22]

The borders of the polygon are given by critical branches which could be either internal or cross-border elements that are significantly impacted by cross-border trade, under N situation or N-k outages. Each state of the grid inside the polygon is defined by the secure operational limits which are respected by (thermal limits, voltage limits, dynamic stability...). Based on local risk evaluation/policy, TSOs hedge themselves against real time changes through reliability margins.

Flow-based calculation of cross-border capacity on intraday basis requires improvement in cooperation between participating TSOs, which allows an increase in coordination between TSOs, in contrast to the opacity and lack of physical meaning of the NTC values.

Flow-based gives more accurate description of the SoS domain. Sometimes TSOs deliberately place NTC corners outside the SoS domain in some market directions that are unlikely to happen in order to maximise NTC domain. These corners are also outside of the FB domain. [22]

For market participants PTDF matrix and AMF+ and AMF- (available maximum flow) values are published. PTDF matrix is calculated and published only for the critical branches which in fact create the SoS domain. AMF represents the physical limitation of the flows on the specific transmission line. PTDF represents physical effect on the grid caused by commercial transactions. In PTDF table we can see for each transaction defined by source and sink the impact on each critical branch. The impact is represented by relative number which basically says which part of the traders flow will go through the critical branch. Flow-based method is approximation of the Direct Current and it only depends on the characteristics of the branches and the network topology. Based on this the impact of a certain transaction defined by source and sink on any critical branch is given by the product of PTDF for the specific critical branch and the transmitted volume.

PTDF matrix for the purposes of intraday trading has to be constantly recalculated since the reference state of the transmission grid is changing constantly. The main factors affecting the flows in the grid are changes in PV and wind farms generation caused by weather changes, power plant outages and changes in the transmission grid topology.

In our CEE region, CAO (Central allocation office) organized two dry-runs of flow-based daily auctions for market participants which indicated that not even participating TSOs fully understand the data they are to be published for market participants. Some of the auctions showed that even one mistake made by some of the participating TSO on a single critical branch can spoil the auction results in the whole region which is a huge risk that none of the market participant want to be exposed to. It was already said that in theory flow-based domain has to be always bigger or equal to NTC defined domain. That was not confirmed in the test so that it

did not generate bigger social welfare for the market as it was expected. It is not likely flow-based daily auctions to start in the near future in the CEE region due to the volatile or unpredictable results showed in the dry-run auctions. [47]

2.5 Transmission Capacities

Transmission capacities play an important role in the market price making process. To be able to fully understand how they affect electricity markets we have to look at some basic terms used for trading purposes. [22]

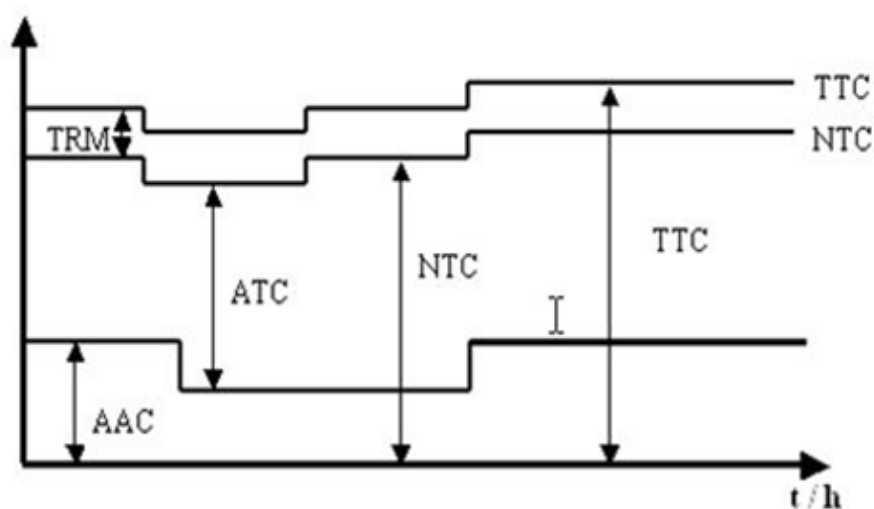

Fig. 2.5 Cross-border capacity terminology for trading purposes [23]

- TTC (Total Transfer Capacity) - represents the maximum exchange of active power between two neighbouring electric power systems that is compatible with operational security standards applied in each electric power system
- NTC (Net Transfer Capacity) - (intended for commercial purposes) represents the difference between the total transfer capacity and the transmission reliability margin
- ATC (Available Transfer Capacity) - Part of NTC that remains available after each phase of the allocation procedure for further commercial activity. ATC is given by the following equation: $ATC = NTC - AAC$
- AAC (Already Allocated Capacity) - Total amount of allocated transmission rights, whether they are capacity or exchange programmes depending on the allocation method
- TRM (Transmission Reliability Margin) - represents a portion of total transfer capacity that must be ensured by the system operator to cover the possible outage of the largest generator in the control area, due to angle or voltage stability problems etc.

There are many ways how transmission capacities can be allocated. For different borders we have different auction types. Usually market participant can allocate the transmission capacity in yearly, monthly, daily and intradaily auctions. Some portion of NTC is made available in yearly auctions. Part of the remaining capacity is made available in monthly auctions and the not nominated capacity from D-2 is available as ATC in daily and intradaily auctions. [43]

In the CEE region between TSOs CEPS, SEPS, MAVIR and TRANSELECTRICA there is no daily auction which is available in the market coupling. Market coupling is the use of so-called implicit auctioning involving two or more power exchanges (PX). In the auction, capacities are allocated automatically in the direction from cheaper to more expensive market so that the price between the markets is flattening. Transmission capacity is allocated only in case price difference exists between the markets. [25]

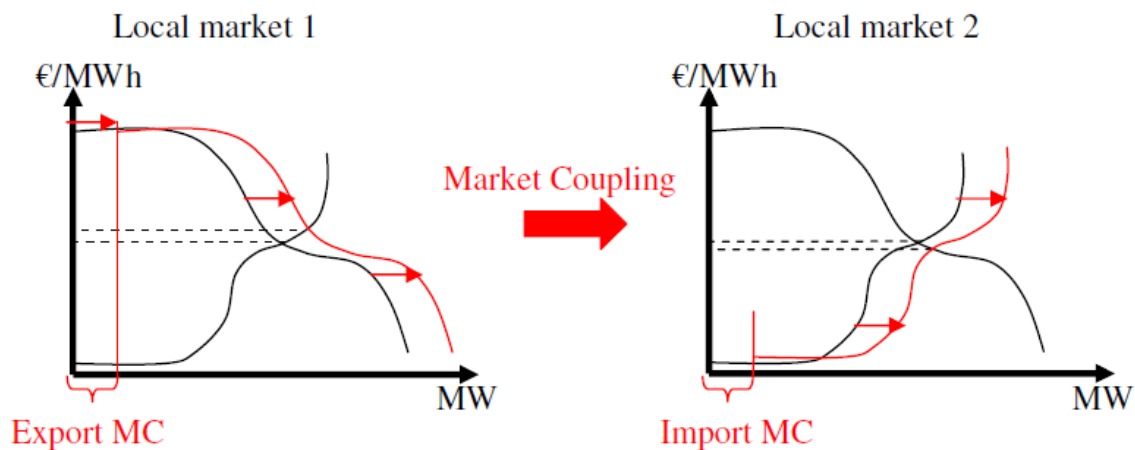

Fig. 2.6 Implicit auction principle between two markets [24]

The purpose of connecting two and more markets is to reach highest social welfare where only the cheapest power generators from all participating markets are dispatched to cover the power demand with the least cost. It gives the market the right impulse to invest in new technologies and to switch-off old, expensive and non-competitive power generators. [49]

2.6 Day-ahead Market

DAM is an organized auction with at least once a day matching process of supply and demand curves and thus fixing prices separately for each hour for the following day. Matching process is calculated for each country separately if no algorithm of interconnecting with neighboring countries is implemented. The target model for day ahead electricity auction is European-wide single price coupling. Market coupling is to deliver liquidity to market participants from neighboring countries, less volatility in the whole market and better security

of supply. To reach this target model lots of work need to be done like harmonization of capacity calculation, gate closure times, schedule nomination times etc. The biggest issue is the harmonization of capacity calculation where we can see that flow-based capacity calculation is being introduced in the CWE region while coordinated ATC based capacity calculation that is simpler is in the core of the capacity calculation processes for the rest of the coupled markets. There is no doubt that flow-based method gives better results compared to ATC based capacity calculation but it is much more complex where we need more data and it is also more difficult to implement. [27]

DAM has been implemented almost everywhere in the EU. Members of the exchange enter their orders into the order book. Deadline for orders submission for most of the markets is between 10:00-12:00. It means that for the first BH we have our wind farm generation forecast let say 12-14 hours in advance and for the last 24th BH we have to have it 36-38 hours in advance. Later I will focus on the deeper implications of the delay between the generation and order gate closure time.

We should focus here on the most liquid European day ahead market operated by the European Power Exchange EPEX SPOT SE. Participating electricity markets are Germany, France, Austria and Switzerland. [16]

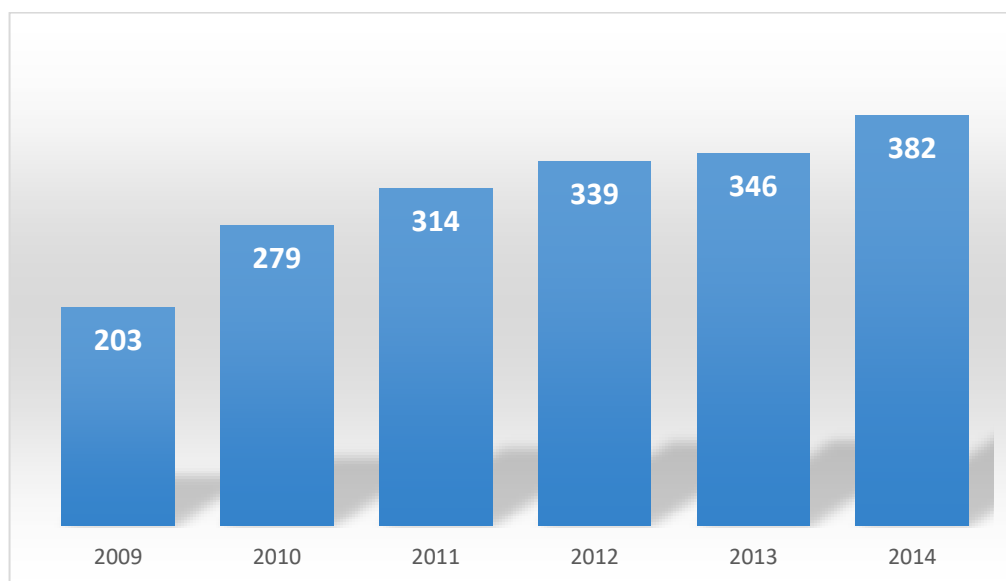

Fig. 2.7 Day-ahead volumes [TWh] [16]

2.6.1 Tradable Contracts

24 hourly contracts are available on the auction, corresponding to the 24 hours of the following day. Hour 1 starts at 12:00 midnight and ends at 1:00 am, hour 24 starts at 11:00 pm and ends at 12:00 midnight. [16]

Single hours with the least volume tick of 0.1 MWh can be traded with specified price limit where the prices can range from -500 to 3000 EUR/MWh.

Combined hourly orders with a minimum of two hours of the day, which depend on each other in their execution where volumes can be different across hours. Blocks are either entirely executed or entirely rejected. Blocks are executed only if they are in the money.

There are also two types of so called smart blocks with additional features compared to standard block orders. Linked blocks is a set of block orders with a linked execution constraint. A linked block family consists of max. 3 generations with 1 block per generation. This is commonly used to find the most optimal time to ramp up or down power plant considering the operating cost. Exclusive blocks is a group of blocks, within which a maximum of one block can be executed. An exclusive group of blocks consists of max. 8 blocks (1 block only is executed). This feature is commonly used to find hour/-s with minimum average price to pump water into the higher reservoir of pumped water storage facility or to find the highest hours or block of hours to generate electricity from pumped water storage facility.

2.7 Day-ahead Market Coupling

Market coupling is a mechanism that allows the optimization of allocation cross-border capacities thanks to a coordinated price formation mechanism. [43]

Traders to be able to profit from divergence in the price on two separate electricity markets need to bid for the cross-border capacities. They are undergoing several risks throughout the whole process. Traders risk the price on the cross-border profile together with possibility that the volume they need will be only partly accepted. Also the whole process of scheduling the nominated capacities is very time-consuming and represents significant risk. In case of some system malfunction either on traders or capacity auction office side the trader stays open or imbalanced on both markets. The open positions will be balanced by the TSOs which represents huge loss for the trader and possible problems with the regulators resulting from creating imbalances and thus breaching grid code. [28], [29], [30]

In market coupling process trader no longer bids for the cross-border capacity and is only placing orders on the corresponding markets. Market coupling process uses the available transmission capacity to minimize the price difference between neighboring areas/markets and allocates it automatically to those participants creating highest social welfare on the market. It is also increasing convergence between the market areas which helps to prevent occurrence of price spikes caused by power plant outage/-s in one of the markets. Successful market coupling project was implemented in CWE (Central Western Europe) managed by EPEX SPOT. Project launched in November 2010 in Central Western Europe. In parallel, CWE has been volume coupled with Nordic region via the Interim Tight Volume Coupling ITVC. [26]

On 4 February 2014, CWE was replaced by the Price Coupling in North-Western Europe (NWE), adding Great Britain, the Nordic and Baltic countries.

2.7.1 How Wind Power Influences Prices on the Day-ahead Market

Wind power installations especially in Germany destabilize and distort prices on the market. They do not give the right market signals since most of the income from wind farms is generated by feed-in tariffs and the power itself is delivered to the market for the minimum possible price. That is why we have more often negative prices since the market is saturated and has problems to take in the generated electricity from renewable power sources.

Wind power is expected to influence prices on the power market in two ways:

- Wind power normally has a low marginal cost (zero fuel costs) and therefore enters near the bottom of the supply curve. This shifts the supply curve to the right, resulting in a lower power price, depending on the price elasticity of the power demand. In general, the price of power is expected to be lower during periods with high wind than in periods with low wind. This is called the ‘merit order effect’. [3]
- As mentioned above, there may be congestion in power transmission, especially during periods with high wind power generation. Thus, if the available transmission capacity cannot cope with the required power export, the supply area is separated from the rest of the power market and constitutes its own pricing area. This is true in an ideal world but for instance market coupling in Central West Europe (CWE) has one single price zone consisting of Germany and Austria despite lack of transmission capacity between both countries. [50] With an excess supply of power in this area, conventional power plants have to reduce their production, since it is generally not economically or environmentally desirable to limit the power production of wind. In most cases, this will lead to a lower power price in the sub-market. [3]

2.8 Balancing Market

With new installed renewables the need for balancing the unpredictable generation increases substantially. The deviations will be either balanced by TSO or by market participants. [46]

In case no flexible intraday trading scheme is available for the market participants, TSO will have to balance the deviation by themselves. This will create pressure on balancing services prices since TSOs will have to tender for more AnS to support the transmission of electric

power and maintain the reliability of the power grid. TSOs can purchase AnS as long or short term contracts (day-ahead) for individual AnS categories.

Part of AnS is purchased by Czech TSO (CEPS) in the day-ahead market for ancillary services. In these auctions marginal price is applied so that highest bid price offered and accepted during given trading hour is used to pay for all AnS bids accepted by ČEPS. Since market participants offering AnS must meet the required technical conditions with regard to its generating units, i.e. so-called certification, the AnS market is not as liquid as day-ahead electricity market which is resulting in higher prices which are sometimes far away from the day-ahead auction prices. For the market participants it is almost always cheaper to balance their imbalances on the intraday market then being balanced by TSO.

In some situations TSOs might not be able to balance the changes of electricity generation from renewables by their own means that is why TSOs associated in ENTSOE are currently working on a scheme where AnS would be provided and activated from generators situated in neighboring TSOs. That would mean diametric change in the whole structure of AnS markets in Europe since most of them are only local markets where generators don't provide ancillary service to neighboring markets.

The most controversial topic connected with the cross-border AnS market is certainly the question of cross-border capacity allocation/reservation for providing these services. If reserves are to be precontracted, corresponding level of cross-border capacity needs to be reserved on day-ahead basis or even before. If for instance this reserve is precontracted/blocked after day-ahead auction it always represents loss of social welfare for the market participants because they are losing a chance to balance themselves on intraday electricity markets because the available intraday transmission capacity is no longer fully available for them so they will be balanced by the TSO which is always expensive. The optimal solution or the acceptable solution from trader's point of view is that TSOs can allocate all the cross-border capacity which is left after the gate closure for intraday capacity auctions. In this case traders have a chance to close all of their open positions on the market and simultaneously help the TSO to minimize imbalances to be balanced. On the other hand there is no need to precontract any services from neighboring TSOs if the TSO has no guaranteed cross-border capacities. [46]

On the balancing market the focus is mainly on manually activated reserves. There is no need for full harmonisation of balancing markets as a prerequisite for cross-border balancing. Nevertheless gate closures, technical characteristics and responsibilities of all major parties have to be harmonised. PCG recommends to start with bilateral TSO-TSO mechanism with multilateral TSO-TSO mechanism as mid-term target model and multilateral TSO-TSO mechanism with CMO as long-term target. Some of the pilot projects already exist. Prerequisite for the market harmonisation is coordinated capacity calculation methodologies amongst

European TSOs together with standards regarding necessary information and information amongst TSOs, generators and traders. Also maximum possible capacities for each time horizon should be provided to the market by respecting TSOs security standards. Target model leads to increased level of coordination and cooperation. Establishment of European-wide common grid model (EU-CGM) implies coordinated reliability assessment, security analysis and transparent calculation methodologies. [46]

2.9 Renewable Energy

Wind and solar power plants are the most volatile renewable energy sources and are in the main focus of investors in energy sector as we can see further in the annual installed capacity growth in the EU and especially in Germany which will be in the main focus as an European leader on the field of electricity generation from renewables. [4]

The purpose of this chapter is to emphasize the need of better forecast accuracy because of ever-increasing wind and solar installations in the whole EU. [4]

Electricity generation from hydroelectric power plants is not in the scope of this thesis and despite water belongs between traditional renewable energy sources it will not be mentioned in this chapter.

2.9.1 Wind Power in Europe

In this chapter I will give some short overview on the current state of wind energy sector in Europe.

It is crucial on one hand to give the TSO where the wind farm is situated the best generation forecast so that it can prepare for it accordingly and on the other hand for the owners of the wind farm to avoid being penalized for the deviations from their schedule.

Emerging new wind power installations in the whole EU create entirely new requirements in the whole energy sector. Main issues connected with wind-produced electricity are loop flows and parallel flows that are causing problems in the neighboring transmission grids that are mutually interconnected. This phenomenon of congested transmission grid unable to transit electricity from large wind farms placed far from centres of population and demand threatens stability and security of transmission networks that might eventually lead to blackout. [14]

Another issue is the impact of renewable sources on the electricity markets in the EU. In recent years we have seen fundamental changes in the market structure, market behaviour and legislation. Because of the increasing wind installations also merit order is fundamentally changing as it was mentioned already above. [3], [43]

2.9.2 Wind Power Installations Facts

- 12.800 MW of new wind power capacity was installed in the EU in 2015 which is slightly higher number compare to 11.791 MW installed during 2014, an increase of 3.8% compared to 2013 annual installations.
 - Of the capacity installed in the EU, 9.766 MW was onshore and 3.034 MW offshore.
 - Wind power installed more than any other form of power generation in 2015
 - Wind power accounted for 44.2% of total 2015 power capacity installations
 - A total of 142 GW is now installed in the European Union. 131 GW onshore and 11 GW offshore.
 - EU wind energy annual installations increased by 6.3% compared to 2014 installations.
 - Annual installations of wind power have increased steadily over the last 14 years, from 3.2 GW in 2000 to 12.8 GW in 2015, a compound annual growth rate of over 9.8%.
 - Wind energy has overtaken hydro as the third largest source of power generation in the EU with a 15.6% share of total power capacity compared to 15.5% from hydro.
 - Wind power's share of total installed power capacity has increased five-fold since 2000; from 2.4% in 2000 to 14.1% in 2014. Over the same period, renewable capacity increased from 24.4% of total power capacity in 2000 to 41.5% in 2014.
- [4]

Germany remains the EU country with the largest installed capacity followed by Spain, the UK and France.

Germany was also the largest market in 2015 in terms of annual installations, installing 6.013 MW of new capacity, 2.282 MW of which was offshore. Only new installations in Germany represented 47% of all new EU installations. Poland came second with 1.266 MW, more than twice annual installations in 2014 and France was third with 1.073 MW. [61]

We can see growing relevance of the offshore industry that doubled the share of annual installations in 2014. Offshore installations accounted for 24% of total EU wind power installations in 2015.

In 2015, 28.9 GW of new power generating capacity was installed in the EU which was 2.4 GW more than in 2014. 12.8 GW was installed in wind, 8.5 GW in PV that together accounts for 74% of total installed power capacity and third coal with only 4.7 GW.

During 2015 in the EU 8 GW of coal capacity, 4.3 GW of gas, 3.3 GW of fuel oil, 1.8 GW of nuclear energy capacity, 518 MW of biomass and 281 MW of wind energy has been decommissioned.

The stress being felt in many markets across Europe throughout the wind industry's value chain should become apparent in a reduced level of installations in 2016, possibly continuing well into 2017.

The EU power sector continues its move away from fuel oil, coal and nuclear, with each technology continuing to decommission more than it installs.

Economic crisis in the EU did not spare the already built and planned renewable power installations or more specifically feed-in tariffs that keep the renewable power sources competitive and make them cheaper compared to conventional sources of electricity. Growth especially in Germany is given by its effective policies, the connection of large amount of installed but not grid-connected in 2014 and a desire by the industry to complete installations before Germany moves to market-based arrangements in 2017. Similarly, Polish developers made use of existing policies and installed over 1.200 MW before new scheme applies in 2016. At the opposite end is Spain where lack of political visibility and ineffective regulations led to fewer installations in 2015 than in previous year. For instance in Spain that has been very strong market new installations fell almost to zero. The wind industry suffered also from changing regulations also in Romania. We can clearly see that stable regulatory conditions are imperative to provide investors with certainty to build new wind power capacities.

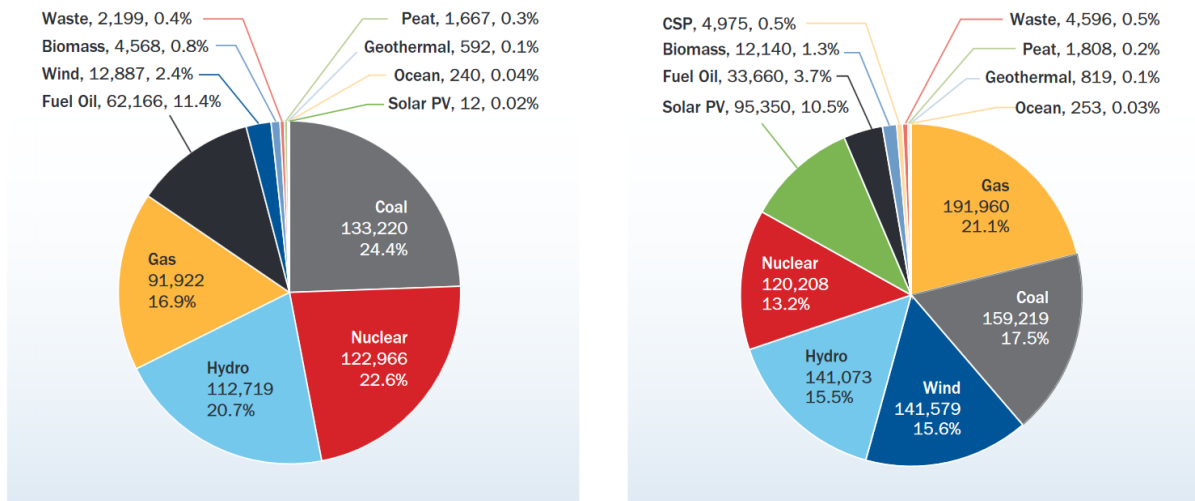

Fig. 2.8 EU power mix in 2000 and 2015 [4]

	Installed 2014	End 2014	Installed 2015	End 2015
EU Capacity (MW)				
Austria	405	2,089.2	323	2,411.5
Belgium	293.5	1,958.7	274.2	2,228.7
Bulgaria	10.1	691.2	-	691.2
Croatia	85.7	346.5	76.2	422.7
Cyprus	-	146.7	10.8	157.5
Czech Republic	14	281.5	-	281.5
Denmark	104.9	4,881.7	216.8	5,063.8
Estonia	22.8	302.7	0.7	303.4
Finland	184.3	626.7	379.4	1,000.5
France	1,042.1	9,285.1	1,073.1	10,358.2
Germany	5,242.5	39,127.9	6,013.4	44,946.1
Greece	113.9	1,979.9	172.2	2,151.7
Hungary	-	328.9	-	328.9
Ireland*	213.0	2,262.3	224	2,486.3
Italy	107.5	8,662.8	295	8,957.8
Latvia	0.4	61.7	-	61.7
Lithuania	0.5	279.6	144.7	424.3
Luxembourg	-	58.3	-	58.3
Malta	-	-	-	-
Netherlands	175	2,865	586	3,431
Poland	444.3	3,833.8	1,266.2	5,100
Portugal	222	4,947	132	5,079
Romania	354	2,952.9	23	2,975.9
Slovakia	-	3.1	-	3.1
Slovenia	0.9	3.4	-	3.4
Spain	27.5	23,025.3	-	23,025.3
Sweden	1,050.2	5,424.8	614.5	6,024.8
UK	1,923.4	12,633.4	975.1	13,602.5
Total EU-28	12,037.4	129,060.1	12,800.2	141,578.8

Tab. 2.3 Power installed in Europe in years 2014 and 2015 [4]

2.9.3 Solar Power in Europe

Germany is paving the path towards renewable sources of electricity and leaving fossil-nuclear age behind. Installed solar power capacity in 2015 reached worldwide 183 GWp, 90 GWp in Europe and ca. 40 GWp only in Germany where the new installed PV capacity momentum still increasing to follow targets set by the German government for the year 2020. This target scenario assumes minimum of 35% generation from RE in total gross power consumption in Germany. In 2030 this target reaches minimum of 50%. PV significantly adds to the total generation from RE with ca. 22 % in 2014. In 2014 PV-generated power covered approximately 6.9 percent of Germany's net electricity consumption. [11]

Still only 7% of total consumption in Germany was covered by the generation from PV. In the last 10 years we have seen also improved performance of solar systems where the efficiency of average commercial wafer-based silicon modules increased from about 12 % to 16 % and efficiency of CdTe module efficiency increased from 9 % to 13 %. [11]

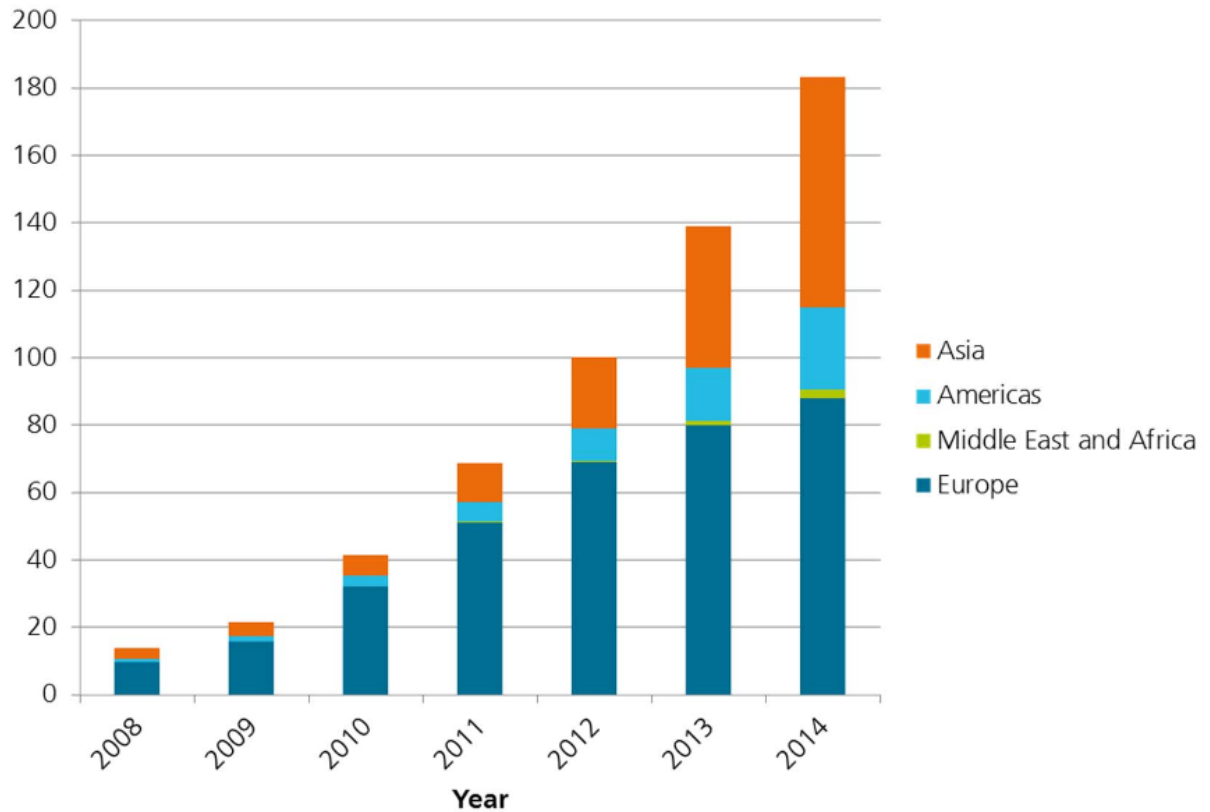

Fig. 2.9 Global cumulative installed PV capacity [GWp] [11]

In this chapter I will look into the problem of balancing volatile PV generation on the electricity markets from a different perspective that includes also cost of balancing on the deviation balancing market.

3 Current Approaches and Working Methods

3.1 State of the Art and Methodology Background

Approaches for wind generation can be categorized into six groups, persistence method, physical method, statistical method, spatial correlation method, artificial intelligence method based on neural networks and hybrid methods. [53]

The physical methods rely heavily on numeric weather prediction, which is confined by the sensors and monitoring devices placed within the wind farm. The quality of hardware chosen, the parameter settings, the computation time, the time delays, and the sampling rates influence the accuracy of data collected. Physical method is using weather forecast data like temperature, pressure, surface roughness and obstacles. In general, wind speed obtained from the local meteorological service is transformed to the wind turbines at the wind farm and further converted to wind power. [53]

Statistical methods aim at finding the relationship of the on-line measured power data. For a statistical model, the historical data is used. Statistical models are easy to model and cheaper to develop compared to other models. Basically, statistical method is good for short time periods. The disadvantage with this method is that the prediction error increases as the prediction time increases. Statistical methods include the auto regressive (AR), auto regressive moving average (ARMA), auto regressive integrated moving average (ARIMA) and Bayesian approach. [53]

Persistence method uses a simple assumption that the wind speed or wind power at a certain future time will be the same as it is when the forecast is made. The persistence method is somehow more accurate than other wind forecasting methods in ultra-short-term forecasting. But the accuracy of persistence method will degrade rapidly when with the time-scale of forecasting is increasing. [56]

The spatial correlation models take the spatial relationship of different sites' wind speed into account. In spatial correlation models, the wind speed time-series of the predicted point and its neighboring points are employed to predict the wind speed. A spatial correlation model is used for predicting wind speed at one site based on measurements at another site. [55]

The object of hybrid models is to benefit from the advantages of each model and obtain a globally optimal forecasting performance. Since the information contained in the individual forecasting method is limited, hybrid method can maximize the available information, integrate individual model information and make the best use of the advantages of multiple forecasting methods thus improving the prediction accuracy. The hybrid methods combine different

approaches such as mixing physical and statistical approaches or combine short-term and medium-term models. [53][60]

Neural network methods are based on the historical data and together with statistical methods have a low prediction cost. The relationship between input data and output data based on historical measured data is learned and then a nonlinear relationship model between them is built. But when new data not previously included in the training data set is used as input into this kind of model, the prediction error might be large, which is a disadvantage. Different prediction methods mentioned above can be combined as hybrid methods to achieve better prediction results. But this will increase the complexity of the model. [54]

In the paper [54] different inputs are gathered such as wind speed, wind direction, wind power generation, humidity and air pressure. Raw data from the farm are processed by a probabilistic neural network and then a complex-valued recurrent neural network model is built to predict the total output of the whole farm. Model is trained on the data collected from one year period and tested on the data from the following year.

In the paper [57] simple time series containing only wind speed measured data has been used to train feed-forward neural network with three layers with the total of forty-eight neurons and using back-propagation algorithm to improve wind speed forecast.

In the paper [58] neural network and stochastic time-series ARIMA model were used to compare the accuracy of wind speed forecasting over different time intervals ranging from days to months. In this case neural networks produced more accurate forecast.

In the paper [59] combination of ARMA-RBF model was used for wind speed and consequently wind generation forecast.

In paper [62] neural network Radial Basis Function Network has been used to estimate wind speed for to following hour. Proposed method does not intend to replace the meteorological models, but to be applied without the need of meteorological data.

We can see that many articles were written on the topic of wind generation forecast by using neural networks but they usually used the usual inputs like wind speed, temperature, wind direction or pressure. In my approach except of the usual inputs also combination of generation forecasts from three different meteorological data providers is used to get best possible generation forecast and that is where the thesis differs from all others.

3.1.1 Quantile Regression

Quantile regression is a statistical tool for data analysis which allows us to model function for arbitrary quantile. From this perspective nonlinear quantile regression is an important tool allowing us a detailed data analysis. Quantile regression is a solution to minimization problem

$$\min \sum_{i=1}^n \rho_{\tau}(y_i - x_i \beta), \quad \text{where } \beta \in \mathfrak{R}^p. \quad (3.1)$$

Where $\rho_{\tau}(z)$ defines linear loss function where τ is the regression quantile value (e. g. 0.05; 0.1; ...; 0.95).

$$\rho_{\tau}(z) = z \cdot (\tau - 1). \quad (3.2)$$

While the solution to least square method

$$\min \sum_{i=1}^n (y_i - \mu)^2, \quad \text{where } \mu \in \mathfrak{R}^p \quad (3.3)$$

estimates the average of responding variable by minimizing of the sum squared errors. Quantile regression minimizes sum of absolute deviations.

Median regression is widely used method interlacing set of responding variables with regression curve where 50% of data is above and 50% below this curve. In general quantile regression calculates for n-th quantile regression function where n-th % of responding variables lies below this curve. [32]

Solution to quantile regression leads to problems in linear programming that can be solved by simplex method.

We choose polynomial as a function to calculate nonlinear quantile regression

$$\alpha * x^0 + \beta * x^1 + \gamma * x^2 + \sigma * x^3. \quad (3.4)$$

Linear quantile regression will not be suitable for our data distribution for reasons that were mentioned already which are the two data clusters in the lower and upper part of the graph Fig. 4.1 and a wide data spread in the middle area. [31], [32], [33]

3.1.2 Neural Networks

History of NN research basically started in 1791 when Galvani recognized the electrical nature of the nervous signals. Another discovery was made by Santiago Ramón y Cajal who proved that neural system is formed by the assembly cells that communicate through

connections called, the synapses. Half a century later creation and propagation of neuronal electric signals was explained by Hodgkin and Huxley and later synaptic transmission was further studied especially by Katz. Today's biology disciplines moved further especially in field of molecules research such as neurotransmitters that are released and cross the synapses between neurons. Neurotransmitter can be considered to be natural chemical messenger that transmits information between neurons. Neurotransmitters are affecting human behaviour such as mood or memory. [6]

Further new neural networks that can act as a memory was developed by Teuvo Kohonen and James Anderson. During 1980s research in neural networks increased dramatically hand in hand together with new and powerful computers. John Hopfield invented associative neural network also known as Hopfield network which is a form of recurrent artificial neural network. Also development of backpropagation algorithm for training multilayer perceptron networks where the most influential publication of the backpropagation algorithm was made by David Rumelhart and James McClelland which is described further in more detail. [9]

Last decade represented a big boom in the field of neural networks with thousands of papers that have been written about new architectures or training algorithms, and neural networks have also found many applications. All of this has been supported with the dramatic increase in performance of computers. [9]

NN are used in fields of pattern or speech recognition, various problems solving, game playing and is vastly used in expert systems. Expert systems simulate human-like decision making ability by drawing new conclusions based on knowledge base that is represented by facts and rules. [6]

An exhaustive list of books provides a guide to the NN and it is not the purpose of this thesis to describe again of what has been written many times about them. Further below I will focus on the well-known and most used model of NN that is MLP. Some theory to understand the behaviour of this NN type will be needed to mention here but I will focus strictly on MLP and different types of NN learning.

In the learning process, the outputs of supervised NN come to approximate the target values given the inputs in the training set. This ability may be good in itself, but often the more important purpose for a NN is to generalise i.e. to have the outputs of the NN approximate target values given inputs that are not in the training set. [2]

Broad range of applications can be found for neural networks such as in field of aerospace for components fault detection, flight path simulations or autopilot enhancements. Latest development of car automatic guidance systems is very promising. In banking sector neural networks are used to check or evaluate credit applicators or for various documents readers. In

defence sector surveillance systems of facial recognition are commonly used together with voice synthesis. In financial sector market forecasting tools are widely used in liquid markets with high volatility. We should not forget on the very promising field such as medicine where application for breast cancer cell analysis, EEG and ECG are commonly used. In the robotics field are utilized various vision systems and manipulator controllers. Speech to text synthesis, market analysis, image and data compression and routing systems applications show that neural networks have already found space for everyday use. [9]

Despite neural networks were inspired by some human brain functions they are only remotely related. I will briefly describe how neural networks were inspired by its biological counterpart. Human brain consists of approximately 10^{11} neurons that are highly interconnected. Neurons consist of dendrites, the cell body and the axon. We can imagine dendrites like nerve fibres that carry signal from the cell body to other neurons. Cell body sums and thresholds signals that get inside. Axon is a projection of a neuron that conducts electrical impulse away to different neurons. Another frequently used term is a synapse that is a contact point between axon of one cell and dendrite of another cell. These are the major building blocks of a neural networks. Artificial neural networks do not even remotely reach complexity of the human brain. Connections between neurons are utmost crucial because they determine the function of the function of the network. [9]

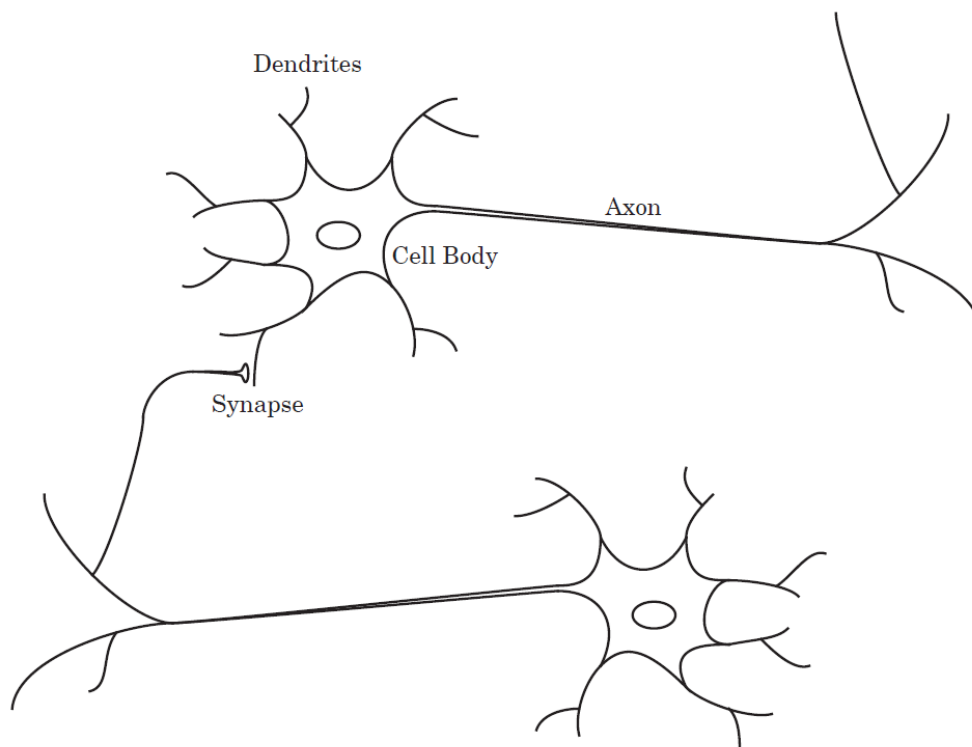

Fig. 3.1 Schematic drawing of biological neurons [9]

3.1.2.1 Multi-layer Perceptrons

Multi-Layer perceptron (MLP) is a feed forward NN with one or more layers between input and output layer. Feed forward means that data flows in one direction from input to output layer (forward). All neurons from one layer are connected with all the neurons from the neighbouring layer except of the input layer and there are no connections between distant layers and also no connections between neurons from the same layer. Impulses that are represented by real numbers are entering each neuron. Each impulse is multiplied by synaptic weight which is also real number referring to the strength or amplitude of a connection between two nodes. The appropriate synaptic weights are applied to the input impulses, and the resulting weighted sum passed to an activation function that produces the output. Each neuron in MLP uses nonlinear activation function.

MLP are widely used for pattern classification, recognition, prediction and approximation. Multi-Layer Perceptron can solve problems which are not linearly separable.

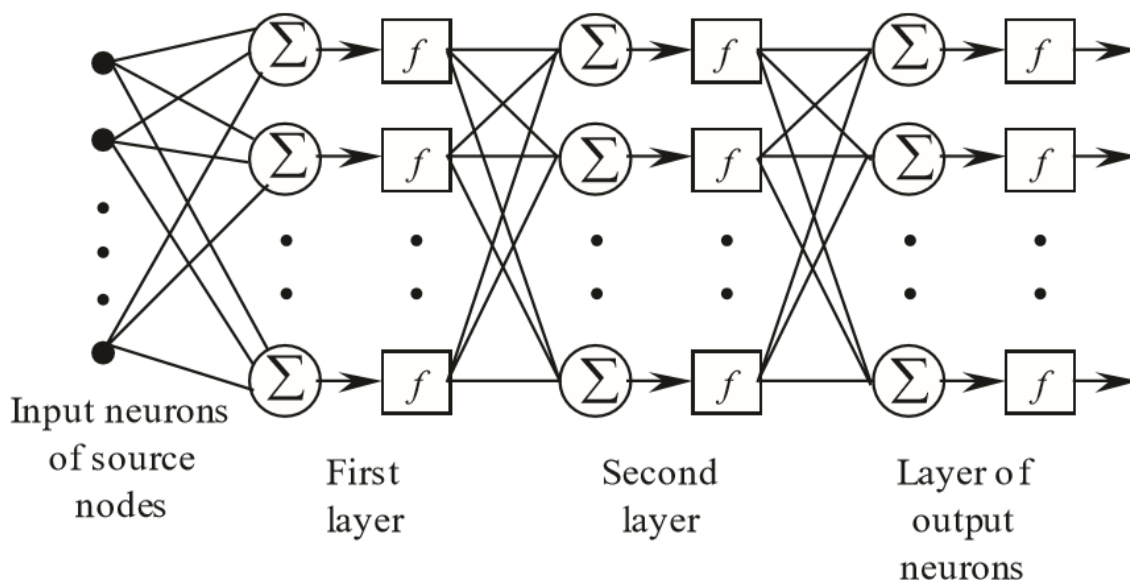

Fig. 3.2 Example of multi-layer neural network [9]

Multilayer networks are more powerful than a single-layer networks. For instance, a two layer network having sigmoid first layer and linear second layer can be trained to approximate most functions in arbitrary precision compared to single layer networks. [10]

3.1.2.2 Recurrent Networks

Recurrent networks are compared to the feedforward neural networks much closer to the biological neural networks which are also recurrent. Recurrent networks is a network with feedback where some of the outputs are connected back to its inputs. This is strictly forbidden in case of a feedforward neural networks. Example of discrete-time recurrent network is shown

in Fig. 3.5. Theoretical and practical difficulties have prevented practical applications so far. There are still problems with supervised training which is extremely difficult but despite this we have already applications like pattern recognition, filtering and prediction, data compression etc. [9]

Basic building blocks of recurrent networks are *Delay block* depicted in Fig. 3.3 and *Integrator* Fig. 3.4.

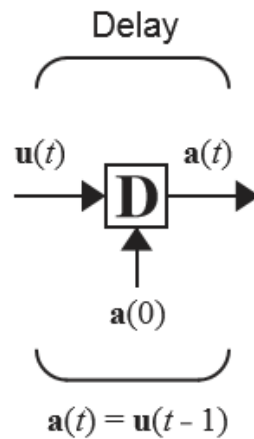

Fig. 3.3 Delay Block [9]

The delay output is computed according to

$$a(t) = u(t - 1) \quad (3.5)$$

Where the output is computed from its one step delay input. Another basic block for building recurrent networks is the *Integrator*.

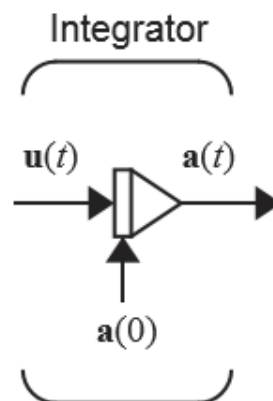

Fig. 3.4 Integrator [9]

The output value of the Integrator is calculated according to

$$a(t) = \int_0^t u(\tau) d\tau + a(0). \quad (3.6)$$

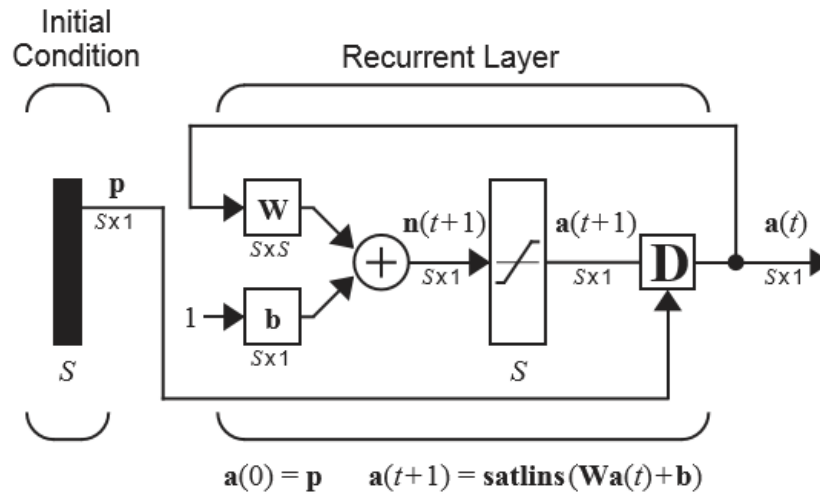

Fig. 3.5 Recurrent Network [9]

Recurrent networks are potentially more powerful than feedforward networks and can exhibit temporal behavior. Example of recurrent networks are Hopfield or Hamming networks. Further description of recurrent networks are beyond the scope of this dissertation. [9]

3.1.2.3 Back Propagation (Learning as gradient descent)

This very popular learning method is suitable for large learning problems and more complicated network topologies. Backpropagation algorithm is numerical method that has been thoroughly studied and is very often used for NN learning. This proves the fact that this method is one of the cores learning method for all three open source frameworks for JAVA which are Neuroph, JOONE and Encog. [5]

The backpropagation algorithm looks for the minimum of the error function in weight space using the method of gradient descent. The combination of weights which minimizes the error function is considered to be a solution of the learning problem. Since this method requires computation of the gradient of the error function at each iteration step, we must guarantee the continuity and differentiability of the error function. Obviously we have to use some kind of activation function other than the step function used in perceptrons, because the composite function produced by interconnected perceptrons is discontinuous, and therefore the error function too. One of the more popular activation functions for backpropagation networks is the sigmoid or tangenoid. [17]

Here we look at the principle of this learning method that is relatively easily programmable.

The NN counts for given input following function

$$y(w): \mathfrak{R}^n \longrightarrow (0,1)^m. \quad (3.7)$$

That is defined by NN configuration w . Calculation is done according to the following logic. At the beginning of training we have only set of inputs $y_i (i \in X)$ where the state of the rest of the neurons is not defined.

In the next step inner potential of all neurons j , that are in the first layer is evaluated.

$$\xi_j = \sum_{i \in j \leftarrow} w_{ji} y_i \quad (3.8)$$

This in general means that in the step n , neurons in the n -th layer are updated. Real state $y_j = \sigma(\xi_j)$ of the j -th neuron is calculated from inner potential by means of activation function

$$\sigma(\xi) = \frac{1}{1 + e^{-\lambda \xi}}. \quad (3.9)$$

For backpropagation algorithm most important property of the activated function is that it is differentiable.

In this way all outputs of all neurons are calculated layer by layer.

In the training process we have set of inputs and desired outputs for the NN that is referred as „training set“. NN error $E(w)$ is defined as the sum of partial errors $E_k(w)$ for each set of training data and depends on the network configuration w .

$$E(w) = \sum_{k=1}^p E_k(w) \quad (3.10)$$

Partial error $E_k(w)$ of the NN for the k -th training pattern is the sum is squared errors of desired and calculated outputs.

$$E_k(w) = \frac{1}{2} \sum_{j \in Y} (y_j(w, x_k) - d_{kj})^2. \quad (3.11)$$

The goal of the NN adaptation is the error minimization $E_k(w)$ in the weight space of the NN. For this purpose we use simplest version of gradient descent method that requires error function differentiability. Adaptation takes place in training cycles. After each training cycle new configuration $w^{(t)}$ is calculated as

$$w_{ji}^{(t)} = w_{ji}^{(t-1)} + \Delta w_{ji}^{(t-1)}. \quad (3.12)$$

Where $\Delta w^{(t)}$ is proportional to the negative gradient of error function $E(w)$ for NN characterized by weights $w^{(t-1)}$ in $t-1$ training cycle

$$\Delta w_{ji}^{(t)} = -\varepsilon \frac{\partial E}{\partial w_{ji}}(w^{(t-1)}), \quad (3.13)$$

where $0 < \varepsilon < 1$ is learning rate, which influences the speed and quality of learning. For the new configuration of NN weights $w^{(t)}$ error function $E(w^{(t)}) \leq E(w^{(t-1)})$. The whole training process is finished when we reach local minimum of the error function. The main problem of this method is that the minimum which is reached can be local but not necessarily global.

To be able to implement the adaptive dynamics defined in (3.12) we need to calculate the gradient of error function (3.13), which is not trivial thing to do. First by using the derivation of the sum rule applied on (3.10) we convert this gradient to sum of gradients of partial error functions

$$\frac{\partial E}{\partial w_{ji}} = \sum_{k=1}^p \frac{\partial E_k}{\partial w_{ji}}. \quad (3.14)$$

Because the network function consists of individual neurons functions, to calculate gradient of partial error function we use the derivative of a composite function rule

$$\frac{\partial E_k}{\partial w_{ji}} = \frac{\partial E_k}{\partial y_j} \frac{\partial y_j}{\partial \xi_j} \frac{\partial \xi_j}{\partial w_{ji}}. \quad (3.15)$$

We get partial derivative $\frac{\partial \xi_j}{\partial w_{ji}}$ from (3.15) as inner potential derivative

$$\frac{\partial \xi_j}{\partial w_{ji}} = y_i \quad (3.16)$$

and partial derivative $\frac{\partial y_j}{\partial \xi_j}$ from (3.16) as activation function derivative which we can express as (3.9) derivative

$$\frac{\partial y_j}{\partial \xi_j} = \frac{\lambda_j e^{-\lambda_j \xi_j}}{(1 + e^{-\lambda_j \xi_j})^2} = \dots = \lambda_j y_j (1 - y_j). \quad (3.17)$$

Substituting (3.16) and (3.17) into (3.15) we get

$$\frac{\partial E_k}{\partial w_{ji}} = \frac{\partial E_k}{\partial y_j} \lambda_j y_j (1 - y_j) y_i. \quad (3.18)$$

To calculate partial derivative $\frac{\partial E_k}{\partial y_j}$ we use backpropagation strategy. Assume that $j \in Y$ is output neuron, then we can calculate this derivative by (3.11) differentiation as

$$\frac{\partial E_k}{\partial y_j} = y_j - d_{kj} \quad j \in Y. \quad (3.19)$$

That corresponds to the error of output neuron j for training pattern k . For hidden neuron $j \notin X \cup Y$ we can use again derivative of a composite function rule where we calculate derivatives which we obtain by direct differentiation.

$$\frac{\partial E_k}{\partial y_j} = \sum_{r \in j \rightarrow} \frac{\partial E_k}{\partial y_r} \frac{\partial y_r}{\partial \xi_r} \frac{\partial \xi_r}{\partial y_j} = \sum_{r \in j \rightarrow} \frac{\partial E_k}{\partial y_r} \lambda_r y_r (1 - y_r) w_{rj} \quad j \notin X \cup Y \quad (3.20)$$

This approach is valid in case the architecture of the NN is not cyclic.

3.1.2.4 Variations on Backpropagation

Backpropagation algorithm is relatively slow in converging. Hence several modifications were introduced to provide speed up and make the algorithm more practical. As it was already mentioned backpropagation is an approximate steepest gradient descent which is very slow optimization method. The conjugate gradient algorithm and the Newton's method generally provide faster convergence. [9]

There are two groups of methods that use different approach for improving performance of backpropagation algorithm. The difference between the algorithms is in a manner how resulting derivatives are used for updating weights. First group of heuristic methods includes ideas like varying the learning rate, using momentum or rescaling variables. The other group uses numerical optimization techniques.

3.1.2.5 Heuristic Methods

Momentum backpropagation is a modification that is trying to improve convergence by smoothing oscillations in the trajectory. This is done with low-pass filter. Filter tends to reduce the amount of oscillation, while still tracking the average value. By the use of momentum we are able to use larger learning rate, while maintaining the stability of the algorithm. [9]

Variable learning rate speeds up the convergence by increasing learning rate on flat surfaces and decreasing learning rate when the slope increases. There are many variations on this variable learning algorithm. One of them is delta-bar-delta algorithm in which each network parameter has its own learning rate. The algorithm increases the learning rate for a network parameter if the parameter change has been in the same direction for several iterations. If the direction of the parameter change alternates, then the learning rate is reduced. This method is faster compared to momentum backpropagation but it requires more storage. It also requires the selection of a total of five parameters that can affect the convergence speed and is also problem dependent.

Main drawbacks to these variations of backpropagation algorithm are that many parameters have to be set while the only parameter that has to be set for the original backpropagation method is the learning rate. Another problem that can occur typically for the more complex algorithms is that they can fail to converge. [9]

3.1.2.6 Standard Numerical Optimization Methods

Conjugate gradient algorithm and the Levenberg-Marquardt algorithm are two successful methods used for multilayer perceptron learning.

Conjugate gradient does not require the calculation of second derivatives, and yet it still has the quadratic convergence property which means that it converges to the minimum of quadratic function in a finite number of iterations.

Levenberg-Marquardt algorithm is a variation of Newton's method that was designed for minimizing functions that are sums of squares of other nonlinear functions. This is very suitable for neural networks training where the performance index is the mean squared error. The algorithm provides a compromise between the speed of Newton's method and the guaranteed convergence of steepest descent. It is supposed to be one of the fastest methods for training multilayer neural networks of moderate size. [9]

3.1.2.7 Generalization and the Choice of Topology

Big problem of multilayer model NN with backpropagation algorithm is (besides error function minimization) choice of appropriate topology for a specific problem. [5] To be able to

design special network architecture we would have to know exact relation between inputs and outputs that is only rarely known. Multilayer topology with one or two hidden layers is mostly used and it is expected that learning algorithm backpropagation will generalize relations from the training set and „translate“ them into corresponding weights between neurons. In this case we have to choose the number of neurons in hidden layers. This closely relates to the ability to adapt and generalization NN problem. Architecture of the multilayer network that is number of hidden neurons, inputs, outputs and number of training patterns should reflect the complexity of solved problem. It is obvious that a small network cannot solve complex problems. In this case such network by using backpropagation algorithm is too small and it usually stops in some shallow local minima and it is needed to supply the topology with additional hidden neurons so that the adaptation has more degrees of freedom. On the other hand rich architecture can allow us to find error function global minima but only by using more computational time. This configuration usually reflects also not only training patterns but also their inaccuracies or errors and gives for test patterns poor results which mean that it does not generalize enough. If the network learns precisely training set data then it in other words does not generalize enough which is called „overfitting“. In the picture Fig. 3.6 are depicted two network functions together with training sets. Bold line represents overfitted network whereas thin line represents function that generalized „properly“ relations in the training set. We can choose the optimal network by properly setting its topology which is on one side sufficiently robust to solve the specific problem and on the other hand not too much robust to correctly generalize relationships between inputs and outputs.

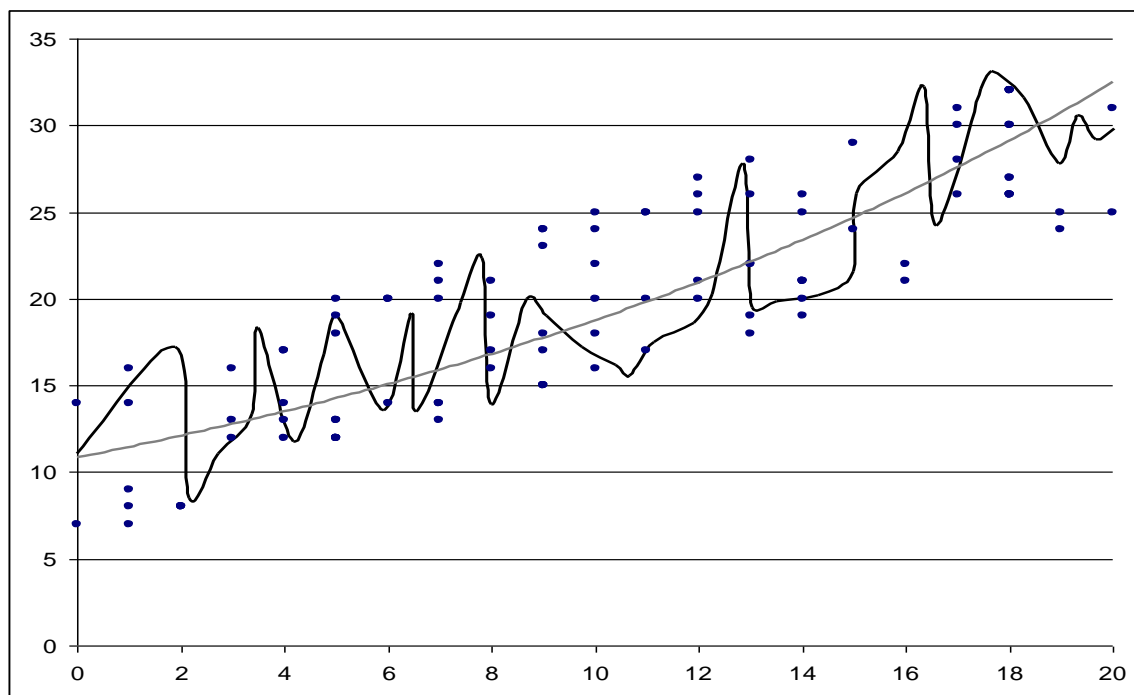

Fig. 3.6 Overfitted function (black) and network with the „right“ generalization (grey) [own]

In practice we can use heuristic approach for determining the number of neurons in the first and second hidden layer. [5] There are many rules-of-thumb that offer us different formulas for the number of neurons in each hidden layer and often they work just fine in specific applications but they may get poor results when solving different problems.

One of the rules says that the optimal size of the hidden layer is usually between the size of the input and output layer.

Other rule says that the number of neurons in hidden layer should be a mean of the neurons in the input and output layer.

The number of hidden neurons should be 2/3 the size of the input layer, plus the size of the output layer. [5]

The number of hidden neurons should be less than twice the size of the input layer. [5]

Another rule that takes into account number of training samples specifies the upper bound number of neurons that should not result in over-fitting.

$$N_h = \frac{N_s}{\alpha * (N_i + N_o)} \quad (3.21)$$

Where N_i represents number of input neurons, N_s number of samples in training set, N_o number of output neurons and α is a scaling factor that is usually set between numbers 2 and 10. Way to determine optimal value α is to start with value 2 and continue to increase this parameter until error for training data is significantly lower compared to the error of our test data set.

Basically there is no standard or accepted method for selecting number of layers or number of neurons for automated building of neural networks. Important thing to mention that increasing number of hidden neurons leads to a small error on the training data set but not necessarily leads to a small error on the test set. [10]

For instance we can use for the first hidden layer a little more neurons then number of input neurons and for the second hidden layer arithmetic mean between number of output neurons and number of neurons in the first hidden layer. In case of higher error after the training process we can add some additional neurons into the hidden layers and in case of very poor generalization we can take away some neurons and the adaptation process is repeated again for the new architecture. To test the NN quality to generalize, network error for the test set data is calculated, which is the part of the training set that was not used in the adaptation.

There are more sophisticated ways during the adaptation part that can modify the architecture of the NN. First so called „constructive algorithm“ starts with very simple topology and in case we can no longer decrease the error of the network, we add new neurons. Opposite approach is used for „pruning algorithm“ where we start with a very robust network and we remove connections that correspond to hidden neurons that during training process have very low weight. That is possible because of the network robustness.

Example in Fig. 3.7 shows that a large number of hidden units leads to a small error on the training set but not necessarily leads to a small error on the test set. Adding hidden units will always lead to a reduction of the training data set error. However, adding hidden units will first lead to a reduction of the test data set error, but then lead to an increase of test set data error. This effect is called the peaking effect. The average learning and test error rates as a function of the learning set size are given in Fig. 3.7.

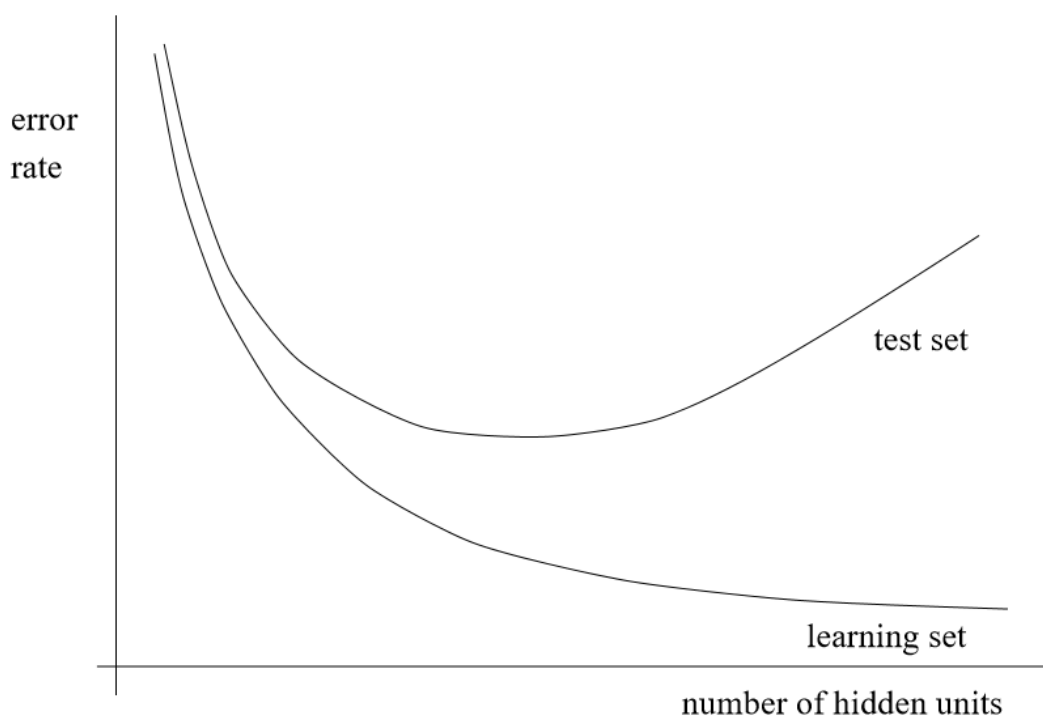

Fig. 3.7 The average learning error rate and the average test error rate as a function of the number of hidden units. [10]

The strategy to find good generalization is to find the easiest model that explains the data. The more complex model we have, the greater the possibility for errors which is what we want to avoid. Translated into the world of neural networks we need to find the simplest model with the lowest number of neurons (weights and biases) and layers that fits best our data. [9]

There are known different approaches to find simple networks such as growing, pruning, global searches, regularization and early stopping. Growing methods start with one neuron and then add neurons until performance suffice. Different style is applied by pruning algorithm where we start with large and complex neural network topology, which most probably overfit, and then remove one by one neuron until the performance degrades. Global searches, such as genetic algorithms, search the space of all possible network architectures to locate the simplest model that explains the data. Both regularization and early stopping, keep the network small by constraining the magnitude of the network weights, rather than by constraining the number of network weights. [9]

Cross-validation is a method that uses validation set to decide when to stop training. In this case we have to split our training set into two parts where one part is used for training and the second part is used for validation. Beside these two parts we also have test set data. During the training process we monitor error of our validation data set. When the error on the validation set goes up for several iterations, the training is stopped, and the weights that produced the minimum error on the validation set are used as the final trained network weights. [9]

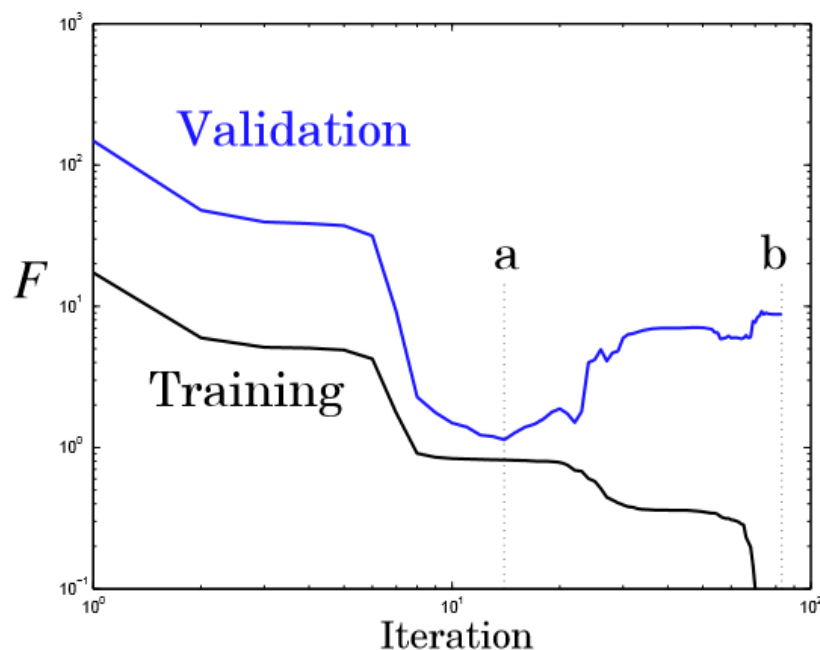

Fig. 3.8 Illustration of Early Stopping [9]

Fig. 3.8 shows the progress of the training and validation performances, where F is the sum of squared errors during training. In point labelled as “a” sum of squared errors for validation data reaches its minimum while minimum error on training data continues to decrease. Point “a” corresponds to “*early stopping point*” while point labelled as “b” corresponds to network overfitting where error on validation has increased while error on train data is on its minimum.

Disadvantage of this method is that we need plenty of data samples that will be split into three subsets and in addition to that all three subsets has to be representative of all situations for which the network will be used that is usually the most difficult task especially in high-dimensional input space. Typically 70% of the data is used for training, 15% for validation and 15% for testing. [9]

Another method mentioned above is regularization. For this method sum squared error on the training set is modified. The modification involves adding a term that penalizes network complexity.

3.1.2.8 Train and Test Data Set

Test set error give us a good indication about the generalization capability of the neural network and indication of how the network will perform in the future. Test set has to cover all regions of data where the network will be used in practice but that can be very difficult especially in case of complex or high-dimensional input space. [9]

If we are about to use neural networks for solving our problem sufficient set of data have to be available for training and testing. Not only the size and quality of our data matters but also the quality and the way we split this set into test and train subsets.

For example, when using the same data pattern over and over again the network may become focused on the first few patterns. This problem can be overcome by using a permuted training method.

The average learning and test error rates as a function of the learning set size are given in Fig. 3.9. Note that the learning error increases with an increasing learning set size, and the test error decreases with increasing learning set size. A low learning error on the (small) learning set is no guarantee for a good network performance! With increasing number of learning samples the two error rates converge to the same value. This value depends on the representational power of the network: given the optimal weights, how good is the approximation. This error depends on the number of hidden units and the activation function. If the learning error rate does not converge to the test error rate the learning procedure has not found a global minimum. [10]

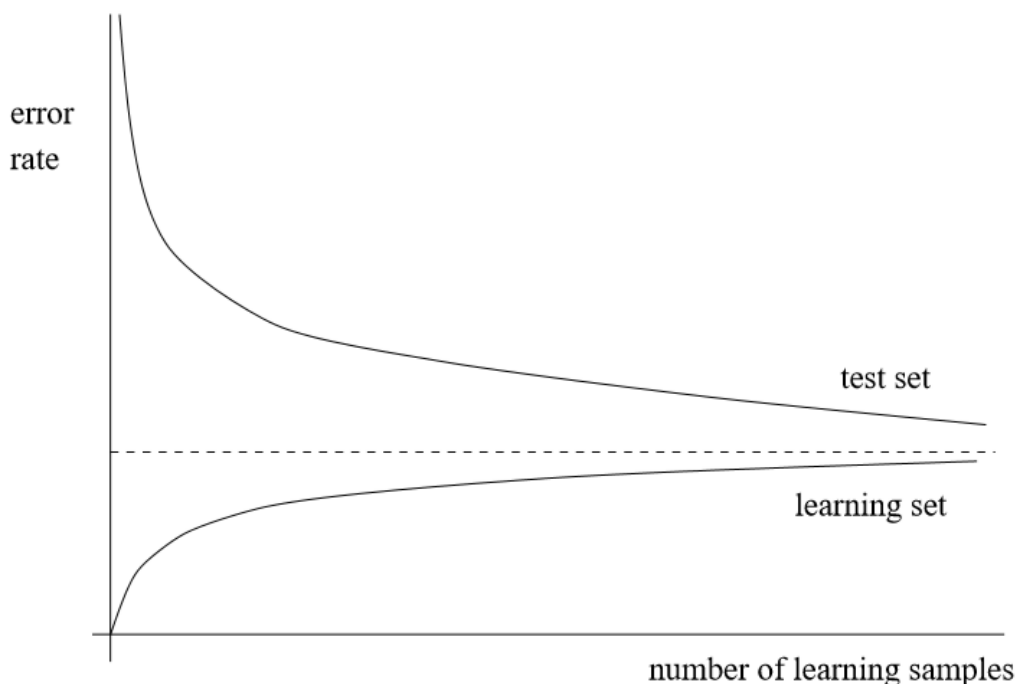

Fig. 3.9 Effect of the learning set size on the error rate. The average error rate and the average test error rate as a function of the number of learning samples. [10]

We may encounter problem of extrapolation, where the network will not perform in the region where no training data exist. The network is extrapolating beyond the range of the input data. The only way to avoid errors of extrapolation is to modify the train data set in a way that we add train samples into the train data set that covers regions with no data. That is the reason why we have to have training data for all regions of the input space where the network will be used. If we have a neural network with a couple of inputs it is not difficult to determine when the network is interpolating or extrapolating but in case of many inputs it is difficult to distinguish. [9]

3.1.2.9 Learning Rate

In the adaptation process after each learning cycle NN error is updated. Values can converge or can after some time sit in some local minima.

Error surface of a neural network is very complex and full of hills and valleys. It can easily happen that neural network can get stuck in some deep local minima. One approach to avoid this is to increase number of hidden neurons. This approach might work because of the higher dimensionality of the error space, and the chance to get trapped is smaller. [6]

Learning rate ε can be updated according to the network error development. For learning that is based on backpropagation algorithm we should fit learning rate to minimize the error function as much as possible which means to find its global minima. While for small ε error

function converges too slowly (error decreases too slowly) for high ε error function diverges (error increases). Learning rate „tuning“ is sometimes reached by trial and error method but even here we might find some recommendations. For larger topologies it is recommended to start with smaller ε that can be thousandths or even lower numbers. This number can be in case of successful convergence of the error function increased and for the case of error function divergence or oscillation exponentially decreased. Even in case of error increase after the previous successful convergence we continue in the adaptation process with the same ε because the method sometimes moves in the weight space from one area to some other area of better convergence. Such a situation might happen that the learning process is better to repeat from beginning for a new starting network configuration. Typical graph of the error development in time during adaptation process is depicted in Fig. 3.10. At the beginning of the adaption process we see that the error might slightly increase, after a while two phases of approximately exponential decrease with long-term stagnation can repeat couple of times and after a long learning in certain conditions we succeed in finding global minimum.

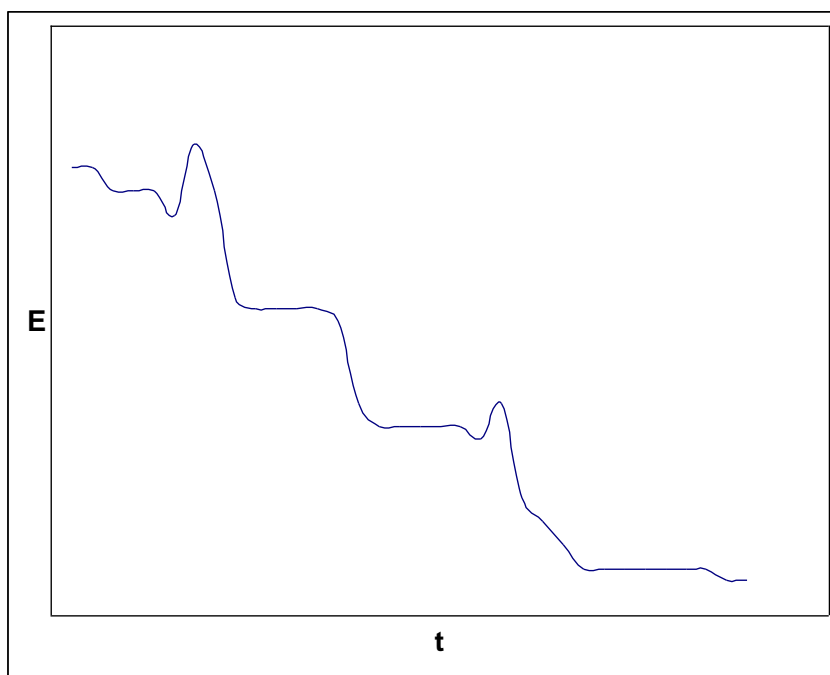

Fig. 3.10 Typical graph of the error development in time [10]

With a low learning rate it takes long time before convergence is reached. For high learning rate no minimum might be reached because of the oscillations.

Learning rate might not necessarily be constant number during the whole training process. Learning rate can be adapted after every training pattern. Basic idea behind this is to decrease the learning rate in case of oscillation. [6]

3.1.2.10 Slope of the Activation Function

We do not have to limit ourselves while searching for global minimum of error function $E(w)$ only for learning rate optimization. We can optimize λ which is a slope in the activation function (1.3) for each neuron in our network in such a way that NN error function $E(w,\lambda)$ will not be only function of a vector of synaptic weights w but also of vector of slopes for each activation function. In the adaptation process we try to minimize the error in the space of weights and slopes. Here we increase degree of freedom of the adaptation process so that we can find easily global minima of the error function but on the other hand we increase processing time of adaptation by increasing number of adapted parameters.

3.1.2.11 Activation Functions

Activation function also called transfer function determines the activation of a neuron dependent on network input and threshold value. If we compare the biological neuron with the basic structure of an artificial neuron, we can notice that the cell body is replaced by the summation unit and the transfer function. Neural networks which consist of neurons connected with nonlinear transfer functions can carry out nonlinear mapping. [8] Activation function is generally defined globally for all neurons, and only threshold values are different for each neuron. By learning threshold values can be changed. There are many types of activation functions. Transfer functions may be linear or nonlinear functions and we usually choose particular function type in order to solve our specific problem. [10]

Choice of an activation function can may strongly influence performance and complexity of neural network. [15]

Binary threshold or hard limiting threshold activation function (a sgn function), which can only take two values. If the input is above threshold value, the function changes from one value to another, but otherwise remains constant. The function is not differentiable at the threshold and for the rest the derivative is 0. Because of this feature we cannot use here back-propagation learning algorithm. If an output is to be either -1 or 1, then a symmetrical hard limit transfer function should be used. [10]

In case of linear or semi-linear activation function, the output unit is simply the weighted sum of its inputs plus a bias term. A number of such linear neurons perform a linear transformation of the input vector. This is usually more useful in the first layers of a network. A number of analysis tools exist based on linear models, such as harmonic analysis, and they can all be used in neural networks with this linear neuron.

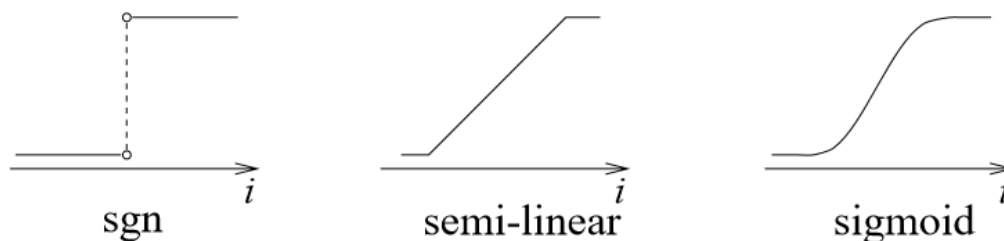

Fig. 3.11 Various activation functions [10]









Smoothly limiting threshold functions. Here we usually use sigmoid (S-shape) function. Sigmoidal transfer functions are most common used despite there are many alternative transfer functions.

Neural networks with single hidden layer using sigmoidal functions are universal approximators, i.e. they can approximate an arbitrary continuous function on a compact domain with arbitrary precision given sufficient number of neurons. These mathematical results do not mean that sigmoidal functions provide always an optimal choice or that a good neural approximation is easy to find. For some datasets a large (and hard to train) network using sigmoidal functions may be needed for tasks that could be solved with a small (and easy to train) network using other transfer functions. [15]

$$y_k = \frac{1}{1 + e^{-s_k}} \quad (3.22)$$

In some cases hyperbolic tangent is used, yielding output values in the range $[-1, +1]$. [10]

The log-sigmoid transfer function is commonly used in multilayer networks that are trained using the backpropagation algorithm. This transfer function takes the input that might range from plus to minus infinity and squashes the output into the range 0 to 1. Most of the commonly used transfer functions are summarized in the Tab. 3.1.

Name	Input/Output Relation	Icon	MATLAB Function
Hard Limit	$a = 0 \quad n < 0$ $a = 1 \quad n \geq 0$		hardlim
Symmetrical Hard Limit	$a = -1 \quad n < 0$ $a = +1 \quad n \geq 0$		hardlims
Linear	$a = n$		purelin
Saturating Linear	$a = 0 \quad n < 0$ $a = n \quad 0 \leq n \leq 1$ $a = 1 \quad n > 1$		satlin
Symmetric Saturating Linear	$a = -1 \quad n < -1$ $a = n \quad -1 \leq n \leq 1$ $a = 1 \quad n > 1$		satlins
Log-Sigmoid	$a = \frac{1}{1 + e^{-n}}$		logsig
Hyperbolic Tangent Sigmoid	$a = \frac{e^n - e^{-n}}{e^n + e^{-n}}$		tansig
Positive Linear	$a = 0 \quad n < 0$ $a = n \quad 0 \leq n$		poslin
Competitive	$a = 1$ neuron with max n $a = 0$ all other neurons		compet

Tab. 3.1 Transfer functions [9]

3.2 Methodology and Model Design

3.2.1 Improving forecast of wind power generation using model based on neural network

Both training and test set should contain various data from the whole range or spectrum of possible inputs and outputs. Training and test set should for this reason contain data ranging from both minimum to maximum values that are equally distributed.

We should collect data at least from one year period where both periods with high and low generation should be present due to seasonality. Generation data ranging from low to high values should be equally represented in the data otherwise there is a potential risk that the neural network will generalize poorly for cases where no or small group of data is available. In case we have a year with overall low generation we should not use our model for forecasting high generation levels. In other case when we have available data from several years we could split data into ranges based on generation magnitude and train several neural networks for different data inputs. Data has to be further normalized in the range $[0, 1]$.

My recommendation is to use recurrent neural network with residual backpropagation learning algorithm with sigmoid activation function. Good practice and the way I proceeded was to start with only one hidden layer of neurons with number of neurons that equals twice the size of input neurons. In case error of our training set is much lower compared to error of our test data set we should decrease number of neurons in the hidden layer until both errors are equal.

In a similar way we should handle all inputs that are available. We should start with all possible inputs and try to remove inputs that are not correlated with the output which is in our case real generation. If the error of our training and test data set gets worse we should keep the input and otherwise we should not use it anymore as the input.

3.2.2 Balancing Residual Positions on Intraday Electricity Markets

Knowledge of the generation probability distribution in hour $H - 0$ as is depicted in the graph Fig. 4.1 allows us to calculate for each value in hour $H - 1$ optimal value to be traded on the market in relation to positive and negative deviation price and the price on the intraday electricity market. In this case we decide whether to buy or sell based on the expected financial effect of our decision which does not necessarily mean that our solution leads to minimization of our deviations.

This leads to optimization problem where we maximize objective function below given an instance $\tau \in (0.05; 0.95)$.

$$\max \left((P_\tau - P_{DA}) c_{ID} + \frac{0.05}{\tau} \sum_{j=0.05}^{\tau} (P_j - P_\tau) c_{NEG} + \frac{0.05}{(1-\tau)} \sum_{k=\tau}^{0.95} (P_k - P_\tau) c_{POS} \right) \quad (3.23)$$

where: P_{DA} already sold electricity on the day ahead market

P_τ maximum generation with probability τ

$P_j P_k$ maximum generation with probability j, k

c_{ID}	price on the intraday electricity market
c_{NEG}	negative deviation price
c_{POS}	positive deviation price

Result of such defined optimization problem is highly dependent on positive and negative deviation prices as it was mentioned already before. Results will vary substantially in different regions where just one common deviation price for both positive and negative deviation price might exist, where negative deviation will be high above electricity price on the intraday electricity market or the balancing market price may be linked to spot market prices. Also market participant can be in some regions either penalized for causing positive deviation or can receive money that can also apply for negative deviation.

Success of this model will depend to a big extent on the system deviation price estimation precision which is given by the whole system balance. Market participant has to be able to estimate the system deviation price to calculate the volume to be traded on the intraday market.

As it was already said this approach leads to P&L maximisation for the market participant given the current conditions on the ID market and the balancing market prices. Market participant is simply choosing whether to balance his portfolio on the balancing or ID market based on the current ID market and expected balancing market price.

According to this method we can estimate based on current market conditions whether market participant will be balanced after the trading deadline of the nearest business hour. We can also say whether the market participant will go for the balancing market with negative or positive deviation. More accurate volume of this deviation can be calculated in case we can estimate precisely enough prices for negative and positive deviation on the balancing market which is not always possible.

Optimization problem formula (3.23) is applicable for any electricity market where short term electricity markets exist. By short term is meant day ahead and intraday market. Another assumption is existing balancing market which is transparent for market participants who can estimate price on the market for both negative and positive deviation.

4 Case Study

Here I will focus on results analysis of models developed both for ID and DAM market trading. Both models can find its application especially considering different time lag between delivery and product trading deadline. We don't always have the chance to balance our generation assets on the ID market that might be illiquid compared to DAM. DAM could be our only chance to trade bigger volumes without much influence on prices.

4.1 Software Solution

In my thesis only free software under Apache 2.0 License or GNU General Public License which is the most widely used free software license, which guarantees end users (individuals, organizations, companies) the freedoms to use, study, share (copy), and modify the software. [1]

4.1.1 Application Core

I decided to program the core of the application in object oriented programming language JAVA for two reasons:

- The most of the widely used Artificial Intelligence (AI) frameworks that are currently used and supported by wide range of developers are being programmed in JAVA for JAVA language. [51]
- Most commonly used programming languages for AI are Java, C/C++ or Python. [52] To write an extensive and robust program you need to have a user friendly programming IDE that allows you to easily maintain your whole project. This suite is best for NetBeans which is an IDE for JAVA that allows you to trace your code very easily with a full-featured debugger and it also provides syntax highlighting, code completion, refactoring support, a rich framework for building desktop Java applications and a clean intuitive UI.

4.1.2 Data Storage

Crucial thing in this thesis is the fast access for data that are fed into the NN. I will be learning NN with different topologies by using different learning methods with varying parameter values for each learning method. For this reason it would not be suitable to store the data in just some text file where the access for this type of data would be too slow. Best and fastest solution is to use a database that can be not only easily accessible from our program or my programming GUI but also from some client that would allow me to manage the data in an easy and efficient way. Solution to that was MySQL database that proved itself over the time to be

reliable and fast. MySQL is also easily installable and operable on different platforms and contains API for JAVA.

4.1.3 Neural Network Framework

For JAVA we have quite a few good options of AI frameworks such as Neuroph, JOONE and Encog. We can reach the fastest learning times with Encog and JOONE compared to Neuroph. Despite this my choice was Neuroph. Firstly because JOONE is no longer supported and secondly Encog has a difficult code to follow and is less user-friendly. Neurophs code is quite easy to use and modify. Above this both Neuroph and Encog have announced collaboration on the development of advanced Java neural network technology so that we can expect the best from Encog to be part of Neuroph. Now it comes with its own GUI called easyNeurons that is also used in my project.

4.2 **P&L Photovoltaic Power Plant Optimization on the Electricity Markets**

Nowadays market participants having RES in their generation portfolio are under pressure to balance their deviations meaning differences between the real electricity output and the actual sold diagram. Balance responsible parties have a couple of possibilities to balance their portfolio. [43]

On daily basis when market participant receives generation forecast for the upcoming day it's possible to trade it on the day ahead market. We are limited here by the precision of such a forecast where we can trade the electricity usually 13-37 hours in advance.

Intraday residue should be traded on the intraday market if there is one. Motivation for deviation balancing is given by the formula for positive and negative deviation calculation. This formula is individual for each region and the market participant is then more or less motivated to balance his position. In case there exists motivation for deviation balancing, sufficient liquidity on the intraday market has to exist to allow balance deviations between expected generation and the already traded diagram. Example of a well-established electricity market is the common market for Germany, France, Austria and Switzerland. [22] EEX intraday market allows to trade 15min. contracts with the least possible volume of 0.1 MW with the closure time of 45min. before the delivery. This gives the trader enough possibilities to balance its residual diagram.

The purpose of tested scenarios that are described further in more details is to demonstrate behaviour of the market participant based on different market conditions. For all scenarios collected generation data from 13-month period starting from 1.6.2011 until 30.6.2012 from

various solar power plants with installed capacity around 1 MW_p situated in cities Mimoň, Grunov and Stráž pod Ralskem were used. For all scenarios generation forecast of our portfolio for the upcoming business hour is based on the PV generation in the previous hour. Without having generation or irradiation forecast it is clearly statistical analysis of the underlying data.

Data was normalized to the maximum theoretical achievable generation for the actual time of the year. In chart Fig. 4.1 you can see two data clusters for areas with low and high generation. Generation in the two adjacent hours is quite similar with small standard deviation.

For the generation range of 20-70 % in hour H – 1, we can observe higher deviation between adjacent hours generation. This is most probably caused by alternating clear skies and cloudy conditions. We can observe highest deviations for the H – 1 generation of 50% of its theoretical maximum.

Nonlinear quantile regression that is widely used in statistics and econometrics was used to estimate the minimum generation with specified probability.

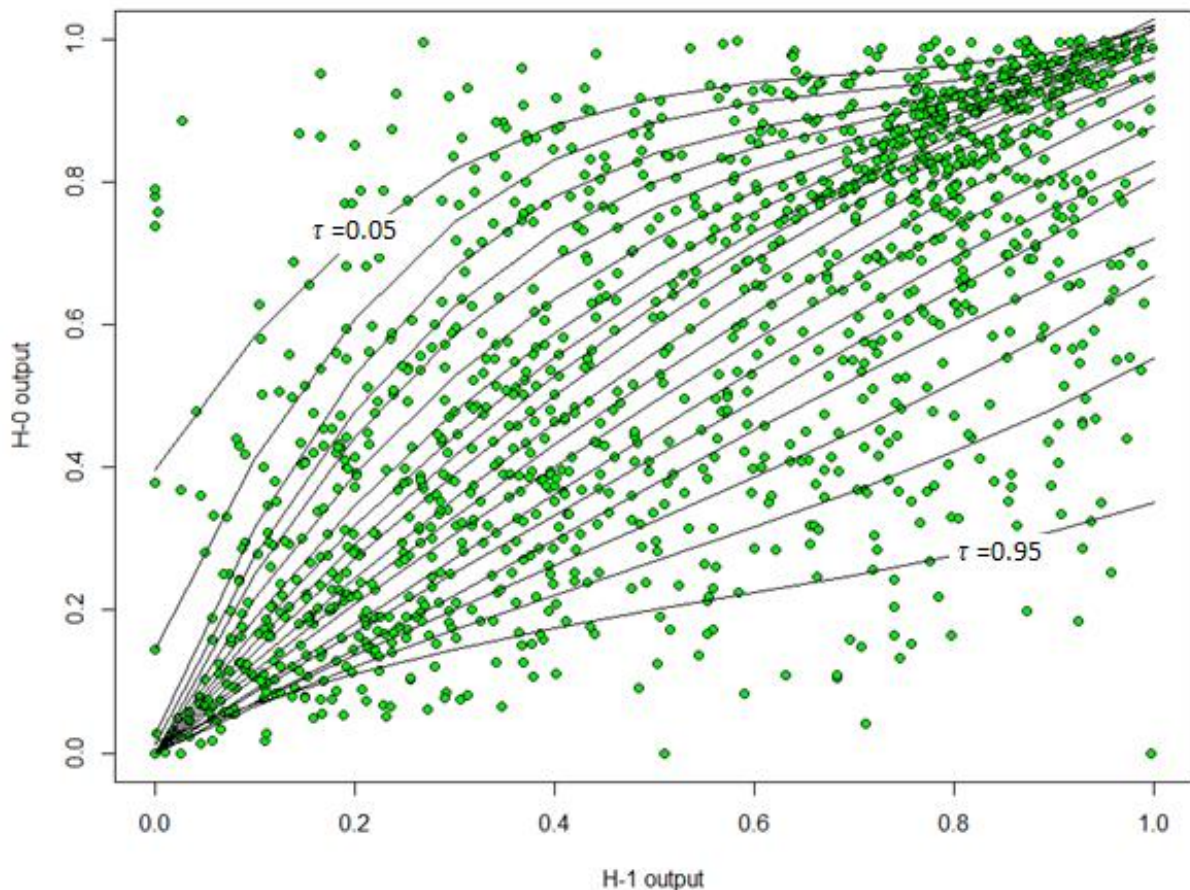

Fig. 4.1 Nonlinear quantile regression for $\tau \in (0.05; 0.95)$ with 0.05 step

In our example we assume that all electricity has to be sold on ID market and none is traded on DA market. In our example market participant is paid 100 [-] for positive deviation and is penalized by -1000 [-] for negative deviation. Both positive and negative deviations are constant and we did not try to change them. This is based on the fact that market participants in most of the cases do not know the exact system deviation prices in real time. These are usually published with one or more days of delay. Deviation price levels were chosen in such a way to motivate market participants not to have negative deviation.

Prices on ID electricity market should be together with H – 1 generation two most important inputs for the trader to decide what volume to trade in the next business hour to maximize his P&L. As a minimum price positive deviation price was chosen because market participant is not motivated for lower prices to sell his generation and so he leaves everything for the balancing market where he is paid positive deviation price. The same applies to maximum ID market price that is not higher than negative deviation price where market participant is not motivated to buy for more than the expected maximum negative deviation price.

In the table below are defined five scenarios where only price of electricity on ID market was changed. Five scenarios were chosen in order to demonstrate changes in the outcome between individual scenarios for ID market prices ranging from 100 to 1000 with the step of approx. 200 [monetary units] to demonstrate the behavior of the model in extreme cases. By extreme prices are considered prices that are either close to minimum market price that should correspond to the minimum price for the positive deviation on the balancing market or maximum market price that corresponds to the maximum price of the negative deviation. To illustrate the transition from one to the other extreme case, couple of scenarios are calculated below in the Tab. 4.1.

	Deviations scenario 1	Deviations scenario 2	Deviations scenario 3	Deviations scenario 4	Deviations scenario 5
Positive dev.	100	100	100	100	100
Negative dev.	-1000	-1000	-1000	-1000	-1000
ID market price	100	300	450	800	1000

Tab. 4.1 Deviation scenarios

Generation delta to be traded in the following hour H-0 relative to H-1 production that generates highest P&L in the long term run given the specific deviation prices conditions [-]. (Generation was normalized to 0-1 range)					
H-1 generation [-]	Deviations scenario 1	Deviations scenario 2	Deviations scenario 3	Deviations scenario 4	Deviations scenario 5
0.05	-0.02	-0.01	0.01	0.08	0.45
0.10	-0.04	-0.01	0.02	0.15	0.48
0.15	-0.06	-0.02	0.02	0.20	0.51
0.20	-0.09	-0.03	0.03	0.24	0.52
0.25	-0.12	-0.04	0.03	0.27	0.52
0.30	-0.15	-0.05	0.03	0.29	0.52
0.35	-0.19	-0.06	0.03	0.29	0.50
0.40	-0.23	-0.07	0.03	0.29	0.48
0.45	-0.26	-0.08	0.03	0.28	0.45
0.50	-0.30	-0.09	0.03	0.26	0.42
0.55	-0.34	-0.10	0.02	0.24	0.38
0.60	-0.38	-0.11	0.02	0.22	0.34
0.65	-0.41	-0.12	0.01	0.19	0.30
0.70	-0.45	-0.13	0.00	0.16	0.25
0.75	-0.49	-0.14	-0.01	0.13	0.21
0.80	-0.52	-0.15	-0.02	0.10	0.16
0.85	-0.56	-0.16	-0.03	0.07	0.12
0.90	-0.59	-0.17	-0.05	0.05	0.08
0.95	-0.62	-0.18	-0.06	0.03	0.05

Tab. 4.2 Delta of electricity generation to be traded in hour H - 0

In the Tab. 4.2 for each scenario are calculated optimal volumes to be traded in order to reach highest P&L of the PV facility with respect to the generation in the preceding hour (H – 1). Negative values represent purchase and positive values represent sale of additional volume.

In the graphs below we can see results for different deviations scenarios. Blue line represents generation in H - 1. Generation for $\tau = 0.05$ and $\tau = 0.95$ is depicted by dashed lines. Red line is the optimum electricity volume to be sold in hour H – 0 given the prices for the specific deviation scenario.

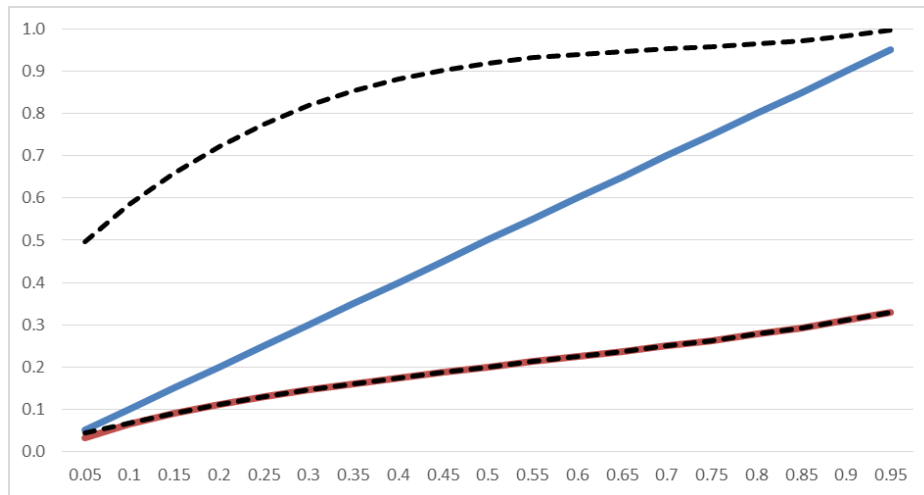

Fig. 4.2 Electricity balancing strategy for deviations scenario No. 1

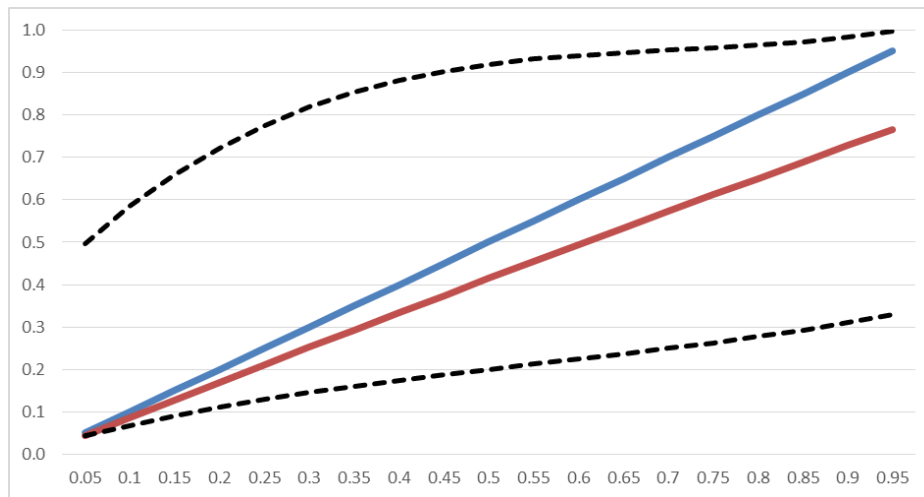

Fig. 4.3 Electricity balancing strategy for deviations scenario No. 2

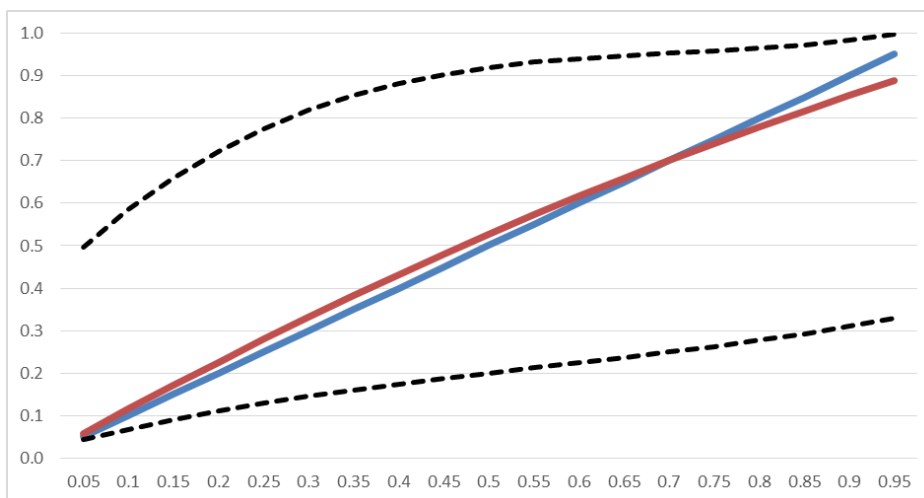

Fig. 4.4 Electricity balancing strategy for deviations scenario No. 3

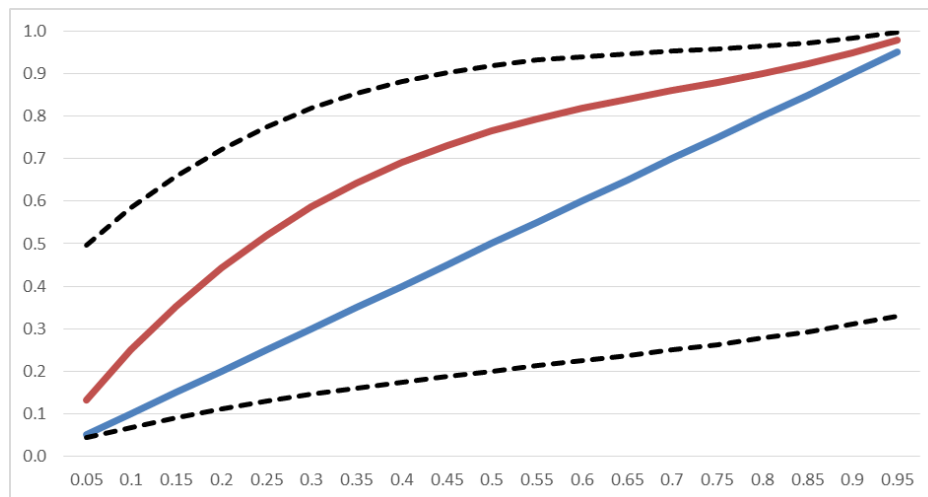

Fig. 4.5 Electricity balancing strategy for deviations scenario No. 4

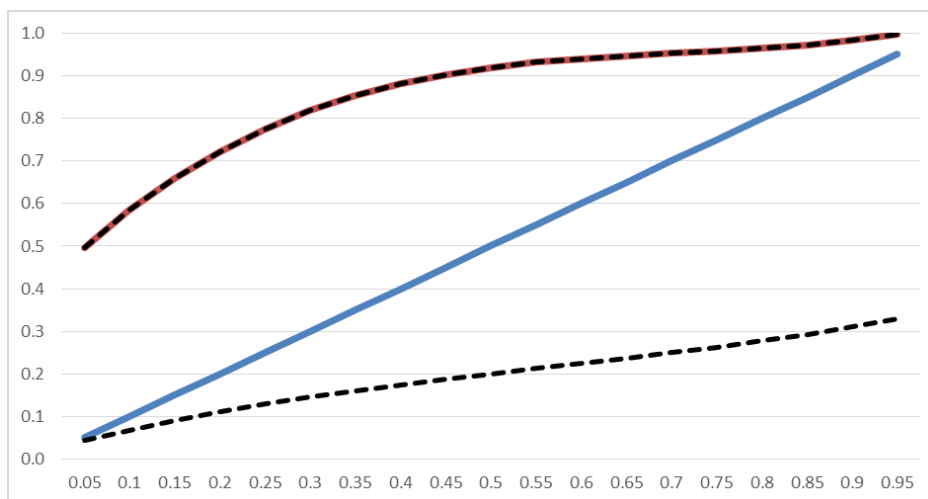

Fig. 4.6 Electricity balancing strategy for deviations scenario No. 5

For first deviation scenario with lowest ID market price that is equal to the positive market price no sale of electricity is made on the ID market. This is because in this case market participant by not selling anything on the ID receives for positive deviation the same amount of money as on the ID market and at the same time he is not risking paying anything for the negative deviation.

With growing price on the ID market also electricity sales is increasing. With increasing market price the financial impact of being unbalanced is mitigating.

We can see maximum sales of electricity in the fifth deviation scenario where price on the ID market is equal to negative deviation price. In this case leaving electricity just for the balancing market can bring the market participant only 100 [-]. If the electricity is sold and generated then profit equals 1000 [-] and in the opposite case market participant does not lose anything.

4.3 Wind Forecasting Model Based on Neural Network for Trading on DAM

Eight different scenarios were formulated in chapter 4.3.1.3. In the Tab. 4.3 below you can see overview of results of each scenario together with results of three independent meteorological providers. Each scenario results are further analyzed in more detail.

	Meteorological forecast provider			Neural Network Scenarios							
	No. 1	No. 2	No. 3	No. 1	No. 2	No. 3	No. 4	No. 5	No. 6	No. 7	No. 8
Minimum	-61.75	-64.44	-76.08	-68.67	-53.38	-50.49	-51.47	-59.42	-54.96	-53.98	-56.41
Maximum	58.88	56.39	66.53	65.42	59.58	60.21	59.96	61.67	60.8	60.07	60.62
Q _{0,25}	-8.006	-7.8	-5.84	-6.02	-5.52	-6.08	-5.23	-5.06	-5.13	-4.99	-5.28
Q _{0,5}	-1.55	-2.6	-0.09	-1.75	-1.27	-1.83	-1.27	-1.19	-1.19	-1.14	-1.44
mean	-2.47	-2.26	0.054	0.23	1.26	-0.4	0.68	1.02	0.77	0.82	0.71
Q _{0,75}	3.825	3.78	6.29	6.54	6.67	5.63	6.07	6.47	6.24	6.28	6.27
Q _{0,75} - Q _{0,25}	11.57	11.58	11.69	12.32	12.19	11.53	11.3	11.53	11.38	11.27	11.55
Q _{0,9} - Q _{0,1}	31.72	28.5	32.43	31.39	28.92	30.19	28.09	28.7	28.26	28.36	28.58
Sum of positive differences	15 923	15 070	22 181	22 710	23 044	19 970	21 134	22 278	21 433	21 588	21 720
Sum of negative differences	27 278	25 289	21 914	21 749	17 246	21 890	18 002	17 566	17 878	17 802	18 452
Sum of absolute differences	43 201	40 359	44 095	44 459	40 290	41 860	39 136	39 844	39 311	39 390	40 172

Tab. 4.3 Results of neural networks scenarios

In five of the eight test scenarios „*sum of absolute differences*“ was below the result of best meteorological provider.

4.3.1 Training and Test Data Set

Data that is available for our NN is historical data from half a year of phased construction where the wind farm was put into operation gradually turbine by turbine and the second half of year data from the completed wind farm. Wind farm is situated in north of Germany with installed generation capacity of 50 MW.

I cannot say in advance if we need five or ten months of training data to teach my NN. In this case I will start with a training set from a few months and check if for a bigger training set my NN results will improve or not. To check if my NN achieves better results compared to the forecasted data I have to validate it against the test data that is the data that was set aside or separated from the training data.

We always have to keep aside set of data that will be used for validation. It would be misleading to use the same set of data for training and testing/validation since we would get smaller error compared to an error for a new set of data that was not included in the training data. That is one of the common mistakes that programmers do while training NN.

If we get bad results for the test data there could be a couple of reasons behind it. One of them is that the data in the test set were not included in the training data. This could easily

happen when our training data set consists mostly of days with low generation output due to the lack of wind and our test set includes days with high generation output. We must be very careful with the selection of train and test data set in order not to have too many identical samples for training but rather smaller and diverse set of training samples. The same applies for the test data set.

Other reason could be the initial values of the random weights. Rerunning the training process again with new weights could correct this. The possibility is also that the training data set was not properly chosen. For this case different approach of separating the data can be made like selecting only odd values as training data and even values as testing data. Sometimes it can happen that the whole data set has to be used as a training set and new data for validation has to be acquired. [5]

4.3.1.1 Generation Data

Our single output of the NN will be the generation for one available turbine. In the second half of the year we had many situations where not all the already built turbines were available. Situations like freezing rain can cause that part of the wind farm is simply put offline. Also technical problems with one of the substations together with necessary tests during specific wind conditions performed for the grid operator were behind the disconnection or the unavailability of some of the turbines.

For this reason we have to normalize our generation data to respect the real number of available wind turbines. Each turbine has its control unit that gives us the information of its generation and status that could be either online or offline. Our normalized generation will be the average generation for a single available turbine.

4.3.1.2 Meteorological Data

We have three sets of data from three different providers of meteorological data. This data include the wind speed, wind direction, real generation and expected output for the whole farm in hourly resolution for the following day. The data also contains information about the temperature and humidity in our location. One of our meteorological provider gives us split of the output generation data for three slightly differently located parts of our wind farm.

4.3.1.3 Inputs for the NN

During my research various scenarios were tested but I left out those with similar results which reduces the total number of further analysed scenarios to eight. Scenarios vary according to their inputs. We have similar inputs from all three providers that are generation from wind, wind direction, temperature and humidity. Range of values that we have available are between

0-360 degrees and these values need to be inherently converted to sinus rhythm to correctly interpret its meaning.

Also interesting input to be tested if it can improve results will be the already measured real generation unfortunately with 14 hours gap between the forecasted data publication and the nearest business hour. That is the better case compared to the 28 hour gap between the forecasted data publication time and the latest business hour.

Eight test scenarios will be NN that will consist of different input combinations from all meteorological providers. In the table Tab. 4.4 we can see which inputs were used for each test scenario.

Data type	Unit	Meteo provider	Neural Network Scenarios							
			No. 1	No. 2	No. 3	No. 4	No. 5	No. 6	No. 7	No. 8
generation - total	MW	1			x	x		x	x	x
generation - total	MW	2		x		x	x	x	x	x
wind direction	°	2								x
generation - part 1/3	MW	3								x
generation - part 2/3	MW	3								x
generation - part 3/3	MW	3								x
generation - total	MW	3	x				x	x	x	x
wind direction	°	3							x	x

Tab. 4.4 Input combinations for neural network test scenarios

In the first three scenarios only one input was used. It is the generation forecast from each meteorological provider separately. Here I try to test whether forecast precision can be improved based only on this elementary information. In this case we search for bias in the whole test data set or in part of the data only.

In scenarios four and five combination of two inputs has been used where both inputs are generation forecast from different meteorological providers. In sixth scenario generation forecast from all three providers has been used. In the next scenario additional input „wind direction“ has been used. In last scenario all available data has been used.

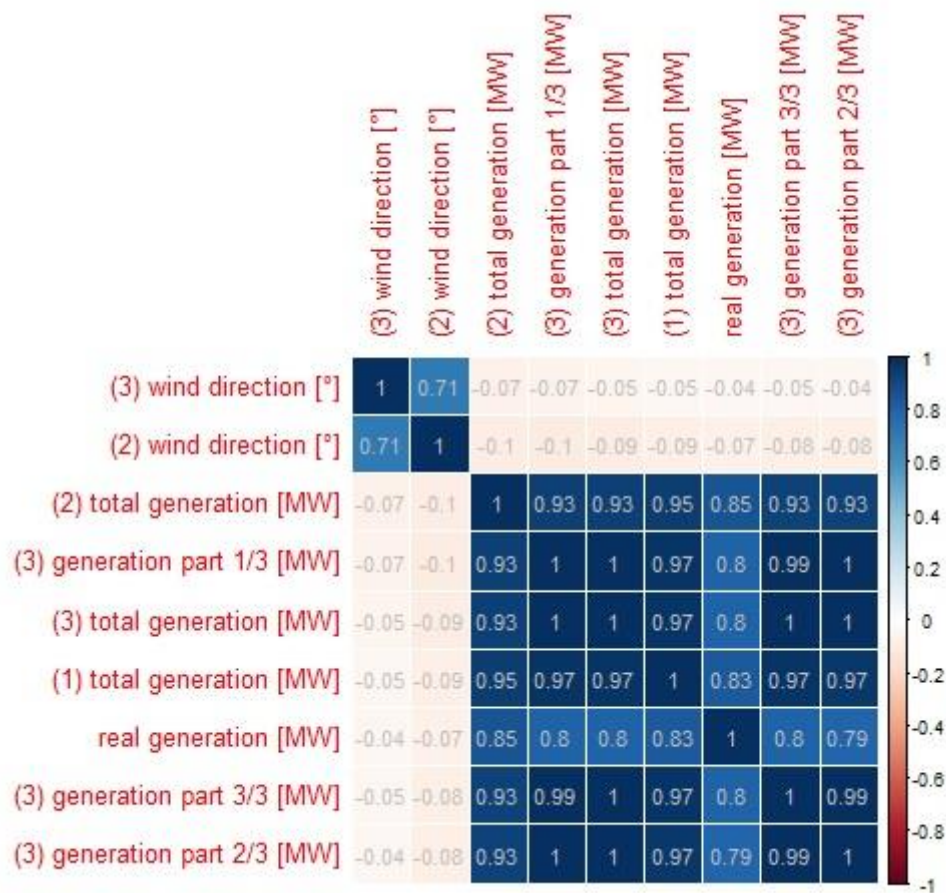

Fig. 4.7 Correlation matrix for all available inputs

In the graphical display of a correlation matrix Fig. 4.7 we can see in advance which inputs will probably have the most substantial impact on the output of our model.

Wind direction information from two meteorological data providers are not correlated with real generation but that does not necessarily mean that it will have no impact, together with generation forecast, on the quality of the model. Quality of the model is defined further in this text. However, we see that both wind direction data sets from meteorological data providers are fairly well correlated.

Correlation between real generation and generation forecast data from all providers ranges from 0,8 – 0,85 while correlation between generation forecasts ranges from 0,93 – 0,97.

4.3.1.4 Output of the NN

Our NN output can be wind speed and wind direction (where we presume that the generation depends also on the direction of the wind) or the generation itself. For wind speed and wind direction outputs we would have to analyze and create conversion table between these two outputs and the generation that is our desired output. To create conversion table we could

easily model another NN with two inputs (wind speed and wind direction) and one output (generation). Because of poor quality of wind speed data I had to settle only for real generation data. For this reason we will do just one NN type with one output that will be the generation instead of modeling two NN that will do the same thing in more complicated way.

4.3.2 Scenarios Design

Scenario No. 1

Scenario with only one generation forecast input from the 3rd meteo provider gave us the worst results from all neural network test scenarios. As it was already mentioned, 3rd meteo provider also gave us in the test period worst relevant results from all three tested providers. Results got even worst by using neural network. Median is as well as in other test scenarios negative. „*Sum of absolute differences*“ criterion is in this case even worst compared to 3rd meteo provider results from the same test period.

Scenario No. 2

Scenario with only one generation forecast input from the 2nd meteo provider which is also the most accurate one. In this case only little improvement was reached. Significant improvement was reached in minimum/maximum range value which decreased by 6,5 %. While in case of trained data set sum of positive differences was bigger than sum of negative differences in case of neural network it is exactly the opposite way.

Scenario No. 3

Scenario trained based on generation input data from 1st meteo provider. Interquartile range, $Q_{0,9} - Q_{0,1}$ quantile range value and „*sum of absolute differences*“ criterion improved compared to 1st meteo provider results from the same test period. Distribution of deviations is in this case also more symmetrical.

Scenario No. 4

Scenario where both generation input data from 1st and second meteo provider were used. This scenario generates best results from all tested scenarios. We see that all calculated statistical indicators improved substantially. Both mean and median are closer to zero compared to results of both meteo providers in the same test period. Also both interquartile range and $Q_{0,9} - Q_{0,1}$ in this scenario give the best results from all tested scenarios. Minimum/maximum range decreased by 8% compared to the best performing meteo provider in the test period. Finally most important „*sum of absolute differences*“ criterion gives the best result compared to all tested scenarios and is better by 3% compared to best meteo provider results. Improvement of 3% can be considered as vital in cost reduction effort because of the decreasing trend in

wholesale market prices caused by the year by year increasing installed capacity in renewables. Decreasing income from electricity sale puts more pressure on precise prediction in order to achieve minimum deviations.

Scenario No. 5

Scenario where both generation input data from 2nd and 3rd meteo provider were used. Scenarios 4, 5 and 6 where more than one input has been used give better results compared to scenarios with only one input. These three scenarios where combination of two and three inputs was used give pretty much similar results for „*sum of absolute differences*“ criterion.

Scenario No. 6

2nd best scenario with all three generation input data from 1st, 2nd and 3rd meteo provider. If we compare scenario 4 and 6 no significant difference was found. By adding generation input from 3rd meteo provider results worsened slightly. In other words, no improvement in results was reached and we can simply ignore generation input data from 3rd meteo provider.

Scenario No. 7

1st scenario where except of all three generation input data from 1st, 2nd and 3rd meteo provider also wind direction information was used. If we compare achieved results with scenario 6 then we can easily see that this additional input did not bring any results improvement. Also correlation table confirmed no relation between real generation and wind direction as we can see in Fig. 4.7. In this case I would suggest to ignore wind direction input and use rather scenario 6.

Scenario No. 8

1st scenario where all inputs has been used. Despite high expectations no surprise happened. We can see slightly wider interquartile range and $Q_{0,9} - Q_{0,1}$.

Distribution of deviations in this case is nevertheless more centered and symmetrical around mean. Interquartile range is also quite wide compared to the rest of test scenarios.

Statistics of Meteorological Data

In the 1st three columns statistics of supplied data from our three meteorological data providers is calculated. Statistics is calculated from deviations between real generation output and forecasted values.

Based on the „*sum of absolute differences*“ criterion which is the most important criterion for us, 2nd provider gives us the best results from all three providers better by 7 % and 9 % compared with the 1st and 3rd provider. Despite both mean and median show us small

systematic deviation, interquartile range value is almost identical for all providers. We can see the most substantial difference for the rest of our data outside the interquartile range. $Q_{0,9} - Q_{0,1}$ quantile range is the narrowest in this case and it is the value where the biggest difference between providers is found. Due to the systematic error in the data we see that sum of negative deviations is higher compared to the sum of positive deviations. Negative deviations participate in the sum of deviations from 62.7 %. This bias creates space for improvement.

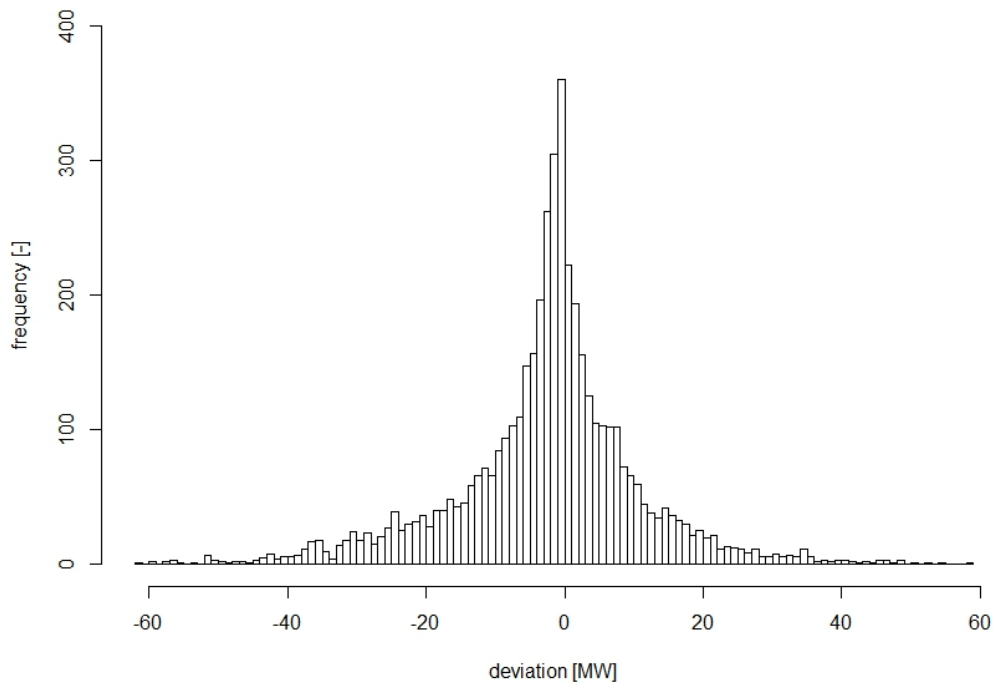

Fig. 4.8 Histogram of deviations data from No. 1 provider

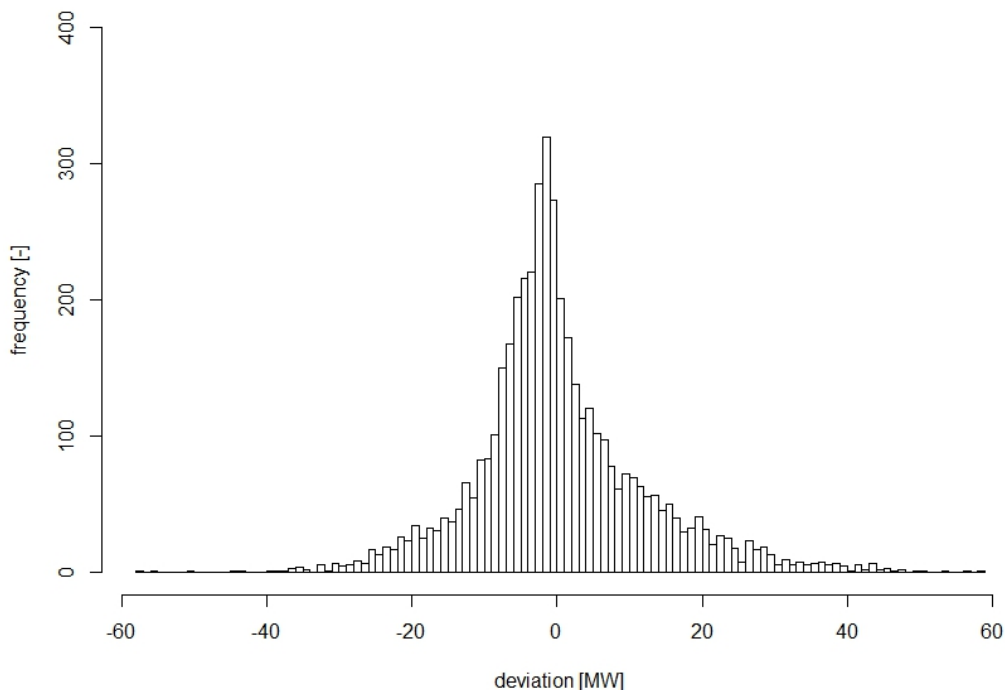

Fig. 4.9 Histogram of deviations data from No. 2 provider

3rd provider has the worst forecast based on the „*sum of absolute differences*“ criterion. On the other hand this data provider made its homework and at least removed bias from his data which is almost zero and is the smallest from all data providers. If we look at the sum of positive and negative differences it is almost the same but $Q_{0,9} - Q_{0,1}$ quantile range is the widest and it is the source of the biggest error.

1st provider gives us results with bias where „*sum of absolute differences*“ criterion is comparable with the results of 3rd provider. While 1st quartile is -8,006 MW third quartile with value 3,825 MW gives very poor results where we can see that the distribution is visibly skewed to the left. We can see here also the highest sum of negative deviations.

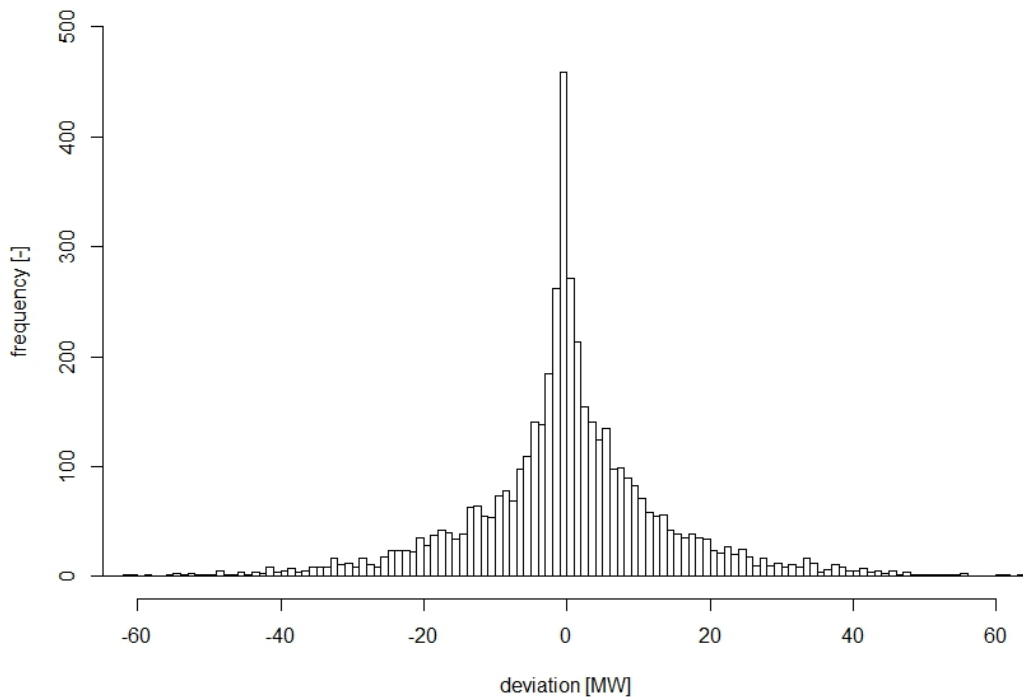

Fig. 4.10 Histogram of deviations data from No. 3 provider

4.4 How to Improve DAM Model for ID Trading

Improvement of achieved results can be reached by adding other relevant inputs into the model. The only measured output that can be also used as an input into the model is in our case real generation. Latest known values of real generation can be easily used as an additional input into our model. Because meteorological data is obtained at 10 a.m., one hour before power exchange bids submission closing time, least hourly difference between latest known real generation value and the nearest business hour is 14 hours.

Additional input into the model in form of last known measured generation has shown on the most important benchmark, which is the sum of positive and negative deviations, that information about real time generation which is older than 3 hours has no effect on the benchmark value.

Not correlated inputs with the output played no role in achieving better results. Not even three inputs that almost perfectly correlate with each other brought any additional value compared to using only the most precise generation forecasts.

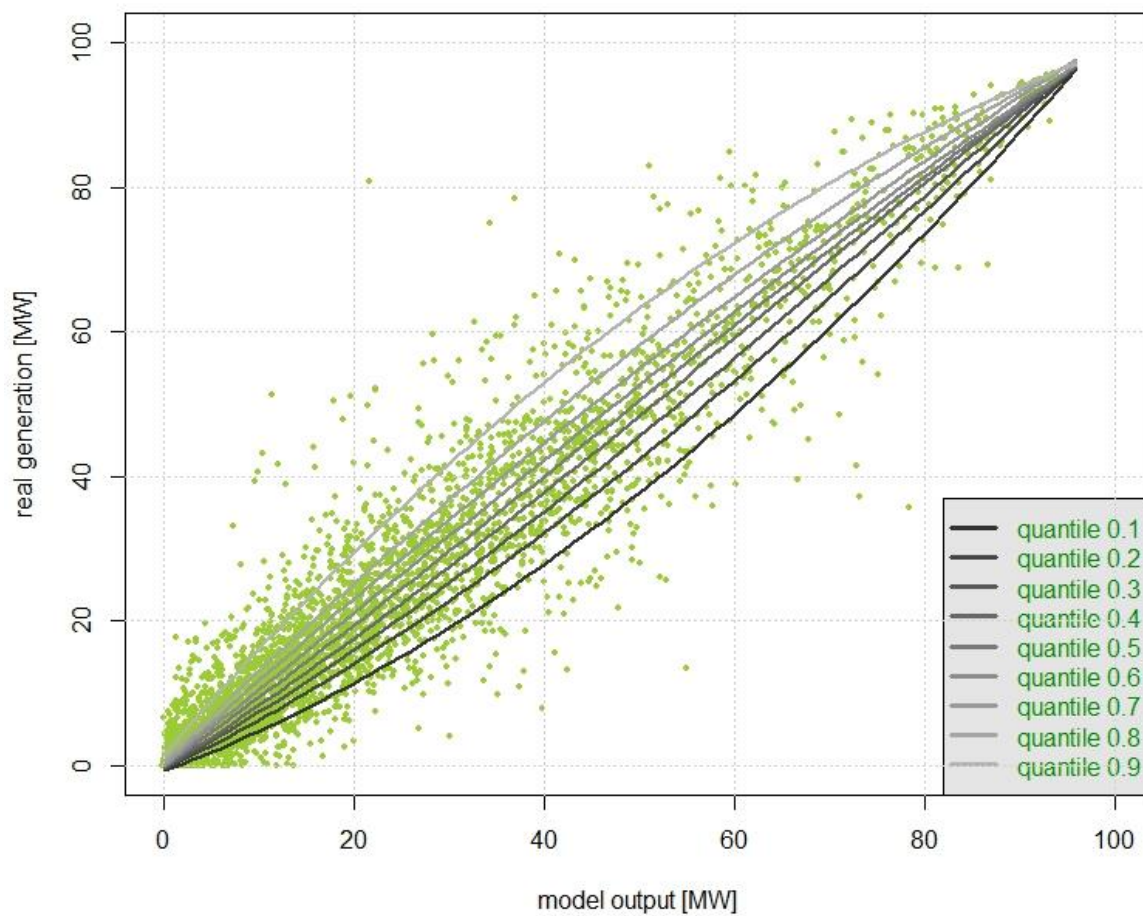

Fig. 4.11 Model output with latest known measured generation as an additional input

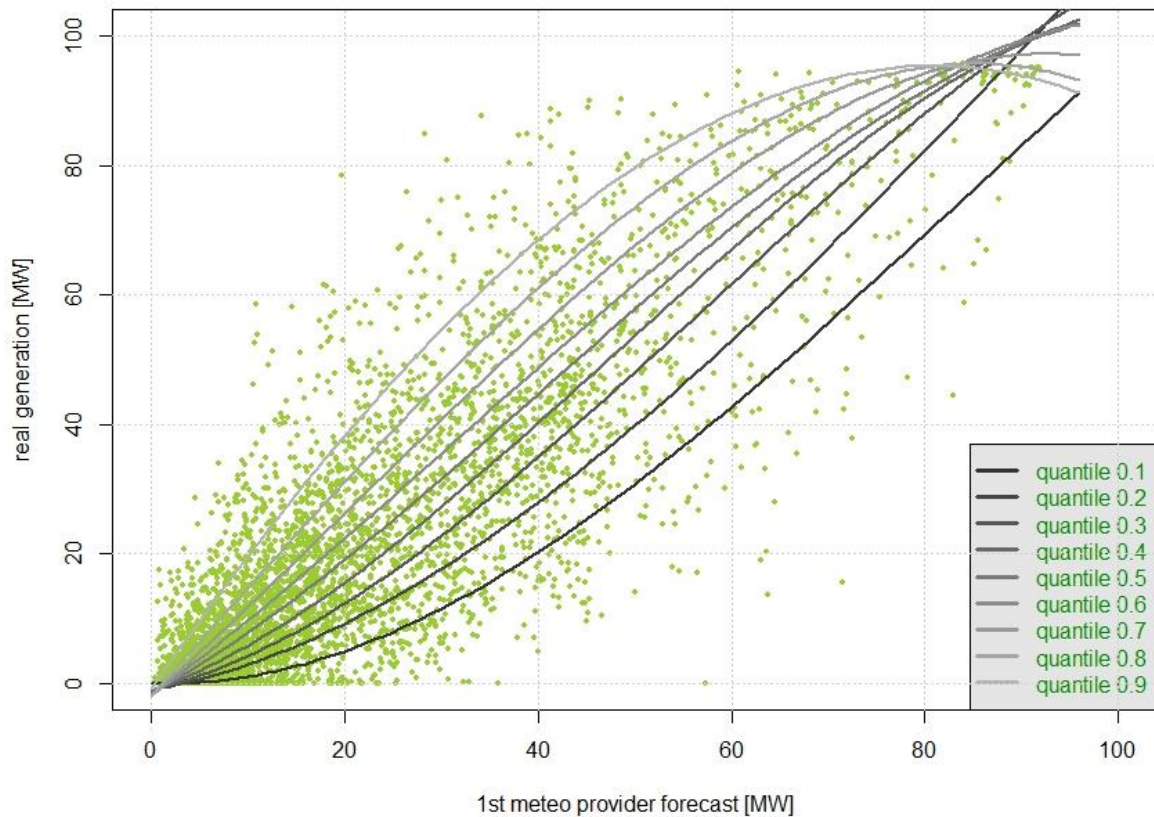

Fig. 4.12 Forecast from 1st meteorological data provider

	H-1	H-2	H-3	H-4	H-5
54%	1	1	1	1	1
54%	1	1	1	1	
54%	1	1	1		
54%	1	1			
51%	1				
0%					
5%					1
9%				1	1
15%			1	1	1
28%		1	1	1	1
54%	1	1	1	1	1

Tab. 4.5 Impact of additional real generation inputs on sum of deviations

Table shows how „*sum of absolute differences*“ criterion depends on the number of additional inputs ranging from the nearest known measured generation denoted as „*H-1*“ to the

latest „H-5“. No improvement of the deviation benchmark has been observed with later hours. First column represents relative improvement of the deviation benchmark criterion compared to the reference scenario with no additional inputs.

First interesting observation of test scenarios is that sum of deviations for scenario with only one additional input „H-1“ will decrease twice the sum of deviations compared to scenario without any additional input denoted as „reference scenario“. Difference between „reference scenario“ and scenario with one additional input „H-1“ is clearly visible in the graphs Fig. 4.11 where regression quantiles are much closer to one another compared to regression quantile in Fig. 4.12. Another representation of the different results is clearly visible in graphs Fig. 4.13 and Fig. 4.14 where deviation regression quantiles are depicted.

Additional input „H-2“ will decrease sum of deviations only marginally and no improvement has been observed with any other additional inputs.

In the second half of the table only one input „H-5“ has brought 5% improvement compared to the reference scenario. Additional „H-4“ input improves sum of deviations by additional 5%. „H-3“ improved „sum of absolute differences“ criterion by 6%, „H-2“ by another 13% and most recent input „H-1“ by 26%. The most influential input is of course the most recent one.

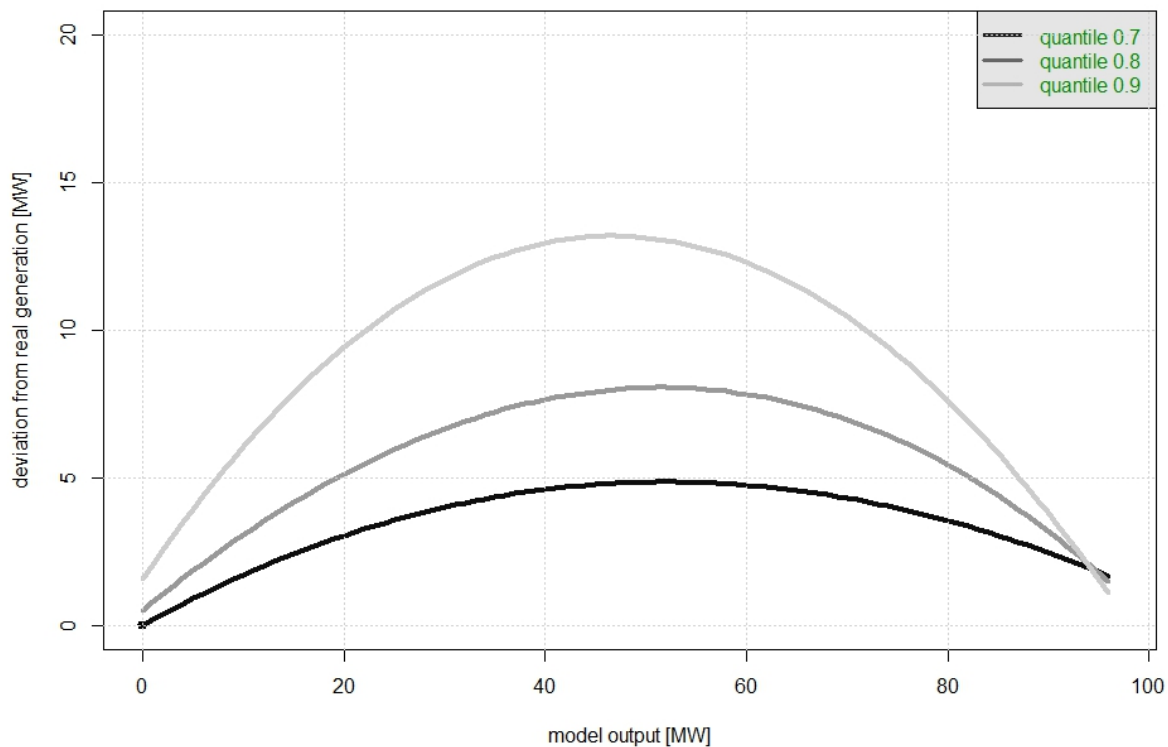

Fig. 4.13 Quantile regression line – deviations from real generation

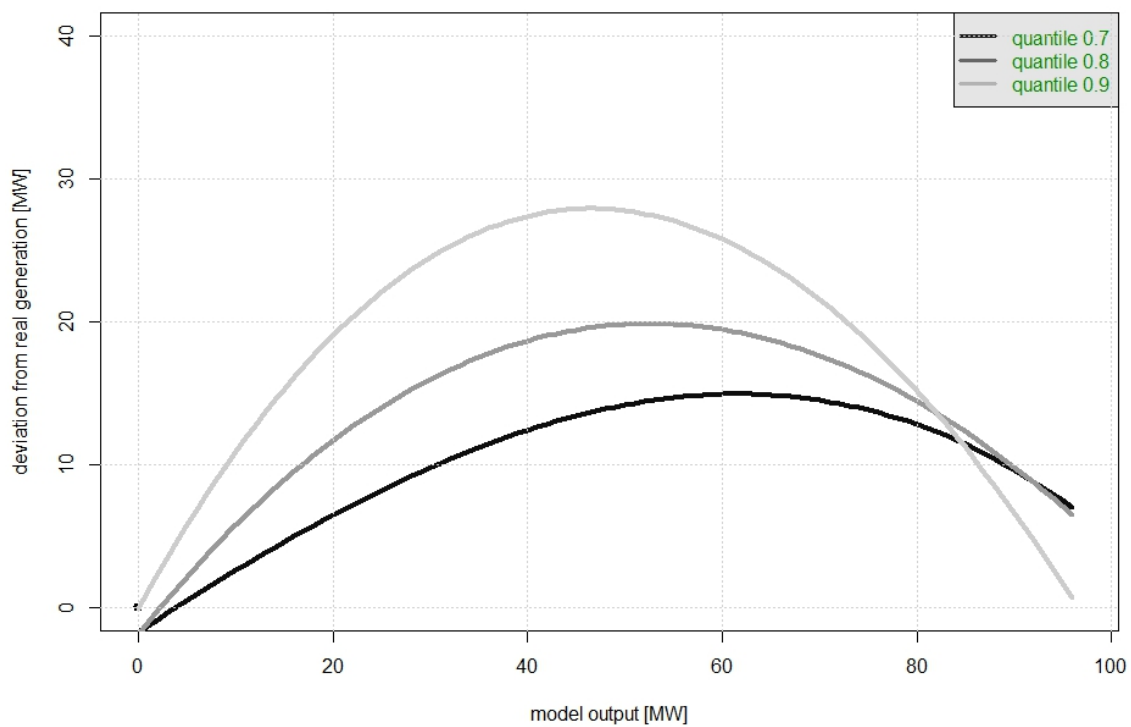

Fig. 4.14 Quantile regression line – deviations from real generation – no additional inputs

If we compare quantile regression lines of both models we can clearly see how additional input reduced deviations.

For day ahead market no reduction of sum of deviations is reached. If we balance deviations on the intraday market 50% reduction of deviation sum can be reached which would be very vital for deviation cost reduction.

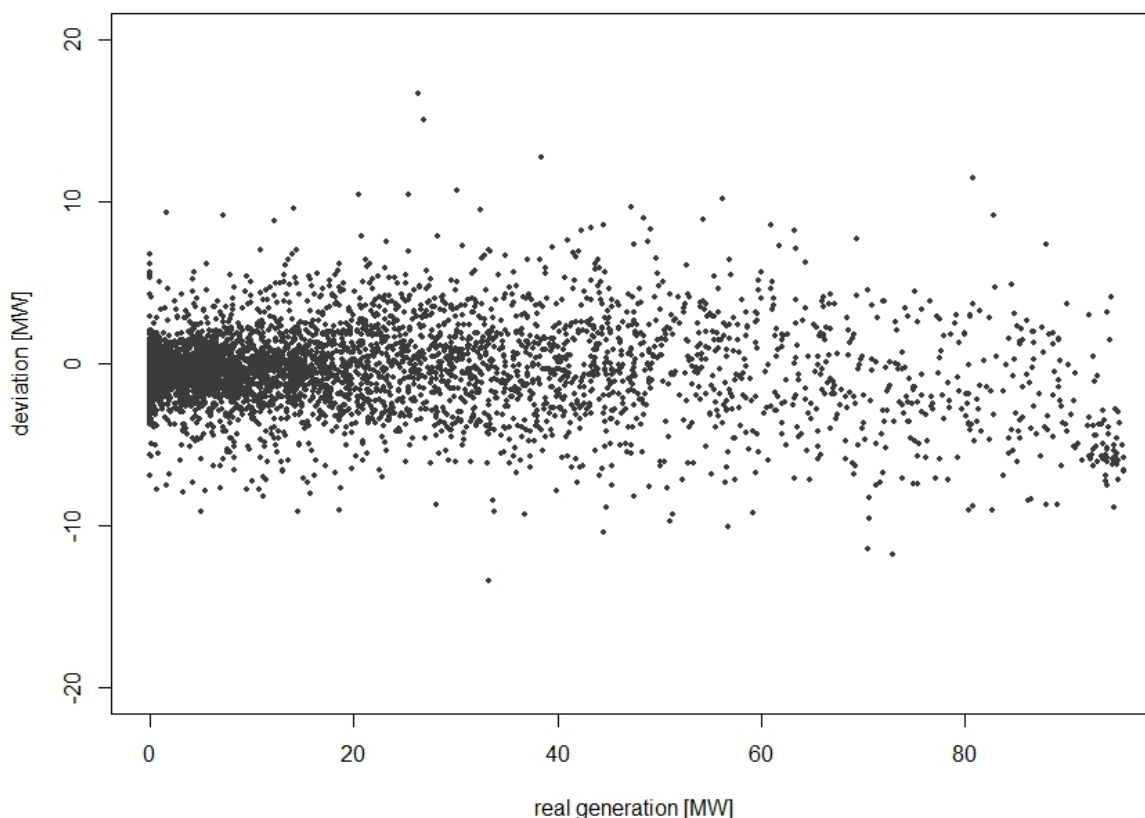

Fig. 4.15 Deviation between 2nd provider and neural network output

In the picture Fig. 4.15 we can see for the whole scope of real generation values from the tested set the deviation between 2nd provider forecast and neural network output.

5 Evaluation of Set Objectives and Proposed Hypotheses

5.1 Evaluation of Hypotheses 1

In chapter 1.1 following hypotheses was formulated: *“Balance responsible parties with renewables in their generation portfolio are not primarily motivated to be balanced.”*

This hypotheses was analysed in chapter 3. For this hypotheses quantile regression as a statistical tool for detailed data analysis in the model was introduced in chapter 3.1.1. For the optimisation problem objective function was formulated in chapter 3.2.2. Result of such defined optimization problem is highly dependent on positive, negative deviation prices and ID market prices which are factors that in our case mostly affect economy of the PV facility. Five different scenarios were analysed in chapter 4.2 where for each scenario optimal volumes of electricity to be traded in order to reach highest P&L of the PV facility with respect to the generation in the preceding hour were calculated in Tab. 4.2.

Optimization problem formula (3.23) is applicable for any electricity market where short term electricity markets exist. By short term is meant day ahead and intraday market. Another assumption is existing balancing market which is transparent for market participants who can estimate price on the market for both negative and positive deviation.

According to this method we can estimate based on current market conditions whether market participant will be balanced after the trading deadline of the nearest business hour. We can also say whether the market participant will go for the balancing market with negative or positive deviation. More accurate volume of this deviation can be calculated in case we can estimate precisely enough prices for negative and positive deviation on the balancing market which is not always possible.

Based on the results of the analysis I **accepted hypothesis 1**.

5.2 Evaluation of Hypotheses 2

In chapter 1.1 following hypotheses was formulated: *“Forecasting model based on neural network gives better results compared to the results of the most accurate meteorological data provider”*.

For this hypothesis overview of neural networks and the theory behind was elaborated in chapter 3.1.1. All underlying training and test data inputs for my model are described in chapter 4.3.1. In chapter 4.3.1.3 eight test scenarios and their inputs are defined. The whole chapter 4 focuses on results analysis. In four of eight test scenarios the most important „*sum of absolute differences*“ criterion gave us better result compared with the result of the most precise

generation forecast data provider. In the best scenario all calculated statistical indicators improved substantially. Both mean and median are closer to zero compared to results of both meteo providers in the same test period. Also both interquartile range and $Q_{0,9} - Q_{0,1}$ in this scenario give the best results from all tested scenarios. Minimum/maximum range decreased by 8% compared to the best performing meteo provider in the test period. Finally most important „*sum of absolute differences*“ criterion gives the best result compared to all tested scenarios and is better by 3% compared to best meteo provider results. Improvement of 3% can be considered as vital in cost reduction effort because of the decreasing trend in wholesale market prices caused by the year by year increasing installed capacity in renewables. Decreasing income from electricity sale puts more pressure on precise prediction in order to achieve minimum deviations.

By using neural networks improvement of forecast precision has been achieved in papers [58] and [59] that are listed together with other papers which are in relation to this problematic mentioned in chapter 3.1. In this chapter different approaches of forecast improvement are listed.

2nd hypothesis is accepted since half of test scenarios gave us better results compared to the results of the most accurate meteorological data provider.

5.3 Evaluation of Hypotheses 3

In chapter 1.1 following hypotheses was formulated: “*Forecasting model based on neural network gives best results if all available inputs are used*”.

This hypothesis was analysed in chapter 4 where results of all test scenarios are thoroughly discussed. Best results were obtained from neural network with only two inputs from eight possible. Scenario with all possible inputs was according to our „*sum of absolute differences*“ criterion 5th from all 8 scenarios. It turned out that not correlated inputs with the output played no role in achieving better results. Not even three independent generation forecast inputs that almost perfectly correlate with each other brought any additional output improvement compared to scenario using only the most precise generation forecasts.

3rd hypothesis is rejected. It was possible to reach better results with not all, but only with some selected inputs.

5.4 Evaluation of Hypotheses 4

In chapter 1.1 following hypotheses was formulated: “*Additional input in form of recent real generation data will improve sum of absolute differences criterion*”.

This hypothesis was analysed in chapter 4.4 where different combinations of additional inputs of measured real generation data ranging from the nearest known generation denoted as

„H-1“ to the latest „H-5“ were tested. First interesting observation of test scenarios is that sum of deviations for scenario with only one additional input „H-1“ will decrease twice the sum of deviations compared to scenario without any additional input denoted as „reference scenario“. Difference between „reference scenario“ and scenario with one additional input „H-1“ is clearly visible in the graphs Fig. 4.11 where regression quantiles are much closer to one another compared to regression quantile in Fig. 4.12.

For the case of intraday contracts that can be traded only until two, three or more hours before the beginning of delivery, analysis of older measured generation inputs were tested which also brought substantial improvement. Real generation data input from hour „H-5“ has brought 5% improvement compared to the reference scenario. Additional „H-4“ input improves sum of deviations by additional 5%. „H-3“ improved „sum of absolute differences“ criterion by 6%, „H-2“ by another 13% and most recent input „H-1“ by 26%. The most influential input is of course the most recent one.

4th hypothesis is accepted. It was possible to reach better results by extending the model with additional inputs in form of recent measured generation data.

6 Conclusions

This paper provides different solutions on how to approach generation forecast for renewables in terms of their subsequent improvements for the purpose of trading this diagram on the DAM and ID. It also gives a brief but comprehensive overview of the structure and design of neural networks.

First model described in chapter 3.1.1 and 4.2 is rather theoretical but gives good idea about the main motivation of market participants that have in their generation portfolio renewable assets. In this specific case data from PV generation asset was used. The main motivation of the electricity market participants is not to be balanced but maximise their profit. This idea led to the formulation of the optimization problem. Based on the optimization problem different scenarios that vary in the input parameters settings were analyzed. Input parameters that drive the market participant's decision making are prices on balancing and intraday market. I demonstrated in my model which was based on quantile regression analysis that even without knowing generation forecast in the coming hours we can make trading decisions based on historical data statistics, current intraday and expected balancing market prices.

In chapter 3.1.2 introduction into neural networks has been elaborated beginning with the history of artificial neural networks development. Further topology of most commonly used multi-layer perceptron and also recurrent neural networks is described. Backpropagation as neural network learning algorithm was described in detail together with some variations of this algorithm that are heuristic and standard numerical optimization methods. Pitfalls of right generalization that is influenced by the network topology is discussed together with proper test and train data set selection. Two chapters were dedicated to setting of activation functions and learning rate that both influence performance of neural networks.

Available data for the model was introduced in chapter 4.3.1 and software solution for the research in chapter 4.1 where Neuroph as neural network framework was chosen as it offers easy to use interface for JAVA together with different neural network architectures with various learning algorithms types, data normalization, easy visualization features and also various samples of its application.

Eight scenarios with different combination of inputs were tested to prove that we can train neural network with historical data that generates better results compared to the best performing meteorological provider in the test period. In five of the eight test scenarios „*sum of absolute differences*“ criterion was better compared to the results of the already mentioned best meteorological provider.

Scenario with all possible inputs was according to our „*sum of absolute differences*“ criterion 5th from all 8 scenarios. It turned out that not correlated inputs with the output played almost no role in achieving better results. Not even three independent generation forecast inputs that almost perfectly correlate with each other brought any additional output improvement compared to scenario using only the most precise generation forecasts.

Best results were obtained from neural network with only two inputs from eight possible. For this scenario all statistical indicators improved substantially. Both mean and median are closer to zero compared to results of both meteo providers in the same test period. Also both interquartile and $Q_{0,9} - Q_{0,1}$ range in this scenario give the best results from all tested scenarios. Minimum/maximum deviation range decreased by 8%. Finally most important „*sum of absolute differences*“ criterion gives the best result compared to all tested scenarios and is better by 3% compared to results of best meteo provider. Improvement of 3% can be considered as a vital in cost reduction effort because of the decreasing trend in wholesale market prices caused by the year by year increasing installed capacity in renewables. Also expected changes in the legislation of many EU states relating to the restriction of the generous support for green electricity in form of feed-in tariffs will result in overall drop in profits. Stakeholders will have to focus much more on the precision of the generation forecast. The reason for this is deviations between traded/forecasted volume and the real generation. These positive or negative deviations are in most of the cases sources of huge loss that has to be minimized.

I proved that neural networks have its place also for improving generation forecast from renewables both for day-ahead and intraday markets. Neural networks as described are a powerful tool to find a solution in cases where it would be very difficult or almost impossible for a human to find a relation between known inputs and outputs of any system which is too complex that has to be consequently expressed in some programming language. NN offer here a solution of how to improve the accuracy without knowing anything concrete about the exact location of individual turbines and how they affect each other in different meteorological conditions. The only information that we needed was a very good set of historical data that would train our NN to improve our prediction model.

In chapter 2 purpose of short term day ahead and intraday markets has been discussed together with the process of electricity markets integration at European level of both markets. Purpose of intraday cross-border capacity auctions in the CEE region and the time line of one trading session has been explained. To fully understand transmission capacities that play an important role in the market price making process I looked into some basic terminology used for trading purposes. Advantages and disadvantages of flow-based method used for capacity calculation, that should reflect real flows, which is gradually replacing obsolete NTC method for both day ahead and intraday capacity allocation were discussed.

In chapter 2.9 I dealt with wind power capacity installation facts and generation mix changes in the EU over the past 15 years that emphasize the need of better forecast accuracy because of ever-increasing wind turbines installations in the whole EU where at the end of 2015 wind power capacity reached 142 GW.

6.1 Possibilities for Further Research

Proposed methodology could be applied on similar problems where long history of data is available. Improving forecast for solar power generation is surely one of the application that could be interesting to investigate. Other learning methods like competitive learning, simulated annealing, convolutional backpropagation, RBF learning, kohonen or hopfield learning would be interesting to test whether they can substantially improve the outcome or just to help sort the data into several subsets that will allow us train neural networks with data that have similar properties. Other way to go is to add derivation of the generation between neighbouring hours as an additional input into the neural network. Neural networks are in general computing systems where many parameters can be changed in both design and training phase. There are different approaches how and when to change individual parameters but not all of the approaches was possible to test in this thesis so there is lot of space for further research.

7 References

- [1] GPLv3 – The Foundations of the GPL: Electronic documents and on-line guides [online] (2013). URL: <http://www.gnu.org/licenses/quick-guide-gplv3.html>
- [2] The Generalisation Ability of Neural Networks. Honours thesis, University of Tasmania : Electronic documents and on-line guides [online] (2004). URL: <http://eprints.utas.edu.au/119/>
- [3] Wind Energy and Electricity Prices, Exploring the ‘merit order effect’: Electronic documents and on-line guides [online] (2013). URL: www.ewea.org.
- [4] Wind in Power, 2015 European statistics: Electronic documents and on-line guides [online] (2015). URL: www.ewea.org
- [5] Introduction to Neural Networks for Java, 2nd Edition, ISBN: 1604390085, Jeff Heaton
- [6] Kröse, B., Smagt, P.: An introduction to Neural Networks, Eight edition, 1996
- [7] Peretto, P.: An introduction to Modeling of Neural Networks, 2nd edition, 1994, ISBN 0-521-41451-2
- [8] Zhang, M.: Artificial Higher Order Neural Networks for Economics and Business, 2009, ISBN 978-1-59904-897-0
- [9] Hagan, T., M., Demuth, B., H., Beale, M.: Neural Network Design, 1996, ISBN 7-111-10841-8
- [10] Kriesel, D.: A Brief Introduction to Neural Networks: Electronic documents and on-line guides [online] (2007). URL: http://www.dkriesel.com/en/science/neural_networks
- [11] Recent facts about photovoltaics in Germany: Electronic documents and on-line guides [online] (2015). URL: <http://www.ise.fraunhofer.de> 2016-03-11_Photovoltaics_Report.pdf
- [12] European Commission.: Energy challenges and policy. Commission contribution to the European Council of 22 May 2013
- [13] Renewable energy Germany: Electronic documents and on-line guides [online] (2016). URL: <http://strom-report.de/renewable-energy/>
- [14] Transmission Network in the Czech Republic and Central Europe in 2013/2015: Electronic documents and on-line guides [online] (2016). URL:

- <https://www.ceps.cz/CZE/Media/Studie-analyzy/Documents/CEPS%20Study%202013-2015.pdf>
- [15] Duch, W., Jankowski, N.: Survey of Neural Transfer Functions: Electronic documents and on-line guides [online] (2016). URL: <http://www.phys.uni.torun.pl/kmk>
- [16] Trading on EPEX spot : Electronic documents and on-line guides [online] (2016). URL: <http://www.epexspot.com/en/extras/download-center/documentation>
- [17] Rojas, R .: Neural Networks A Systematic Introduction, 1996, Springer-Verlag
- [18] Vědecké metody ve společenských vědách, Evropský sociální fond Praha & EU. 2009.
- [19] Energy Turnaround Products: Electronic documents and on-line guides [online] (2016). URL: <https://www.eex.com/blob/84590/04062091590a44b6afedaeda6ef02708/20150210-working-paper-energy-turnaround-products-data.pdf>
- [20] FITS – The Flexible Intraday Trading Scheme: Electronic documents and on-line guides [online] (2011). URL: http://www.ceer.eu/portal/page/portal/EER_HOME/EER_ACTIVITIES/EER_INITIATIVES/ERI/South-West/Meetings1/IG_meetings/8supthsup%20SW%20IG/DD/20110412_FITS%20presentation_EPEX_Sounth-West%20IG.pdf
- [21] Intraday Implicit Cross-Border allocation on BE-NL and BE-FR borders: Electronic documents and on-line guides [online] (2016). URL: <http://www.creg.info/pdf/Opinions/2015/B1467/Annex3.pdf>
- [22] CWE Market Coupling: Electronic documents and on-line guides [online] (2016). URL: https://www.belpex.be/wp-content/uploads/Final_pres_Technical_Forum_01-06-2011.pdf
- [23] ELES - Vocabulary: Electronic documents and on-line guides [online] (2016). URL: <http://www.eles.si/en/for-business-users/descriptions.aspx>
- [24] Adamec, M., Indrakova, M., Pavlatka, P.: Electronic documents and on-line guides [online] (2016). URL: http://www.aee.at/2009-IAEE/uploads/fullpaper_iaee09/P_521_Pavlatka_Pavel_7-Sep-2009,%208:59.pdf

- [25] Flow-based Market Coupling (FMC): Electronic documents and on-line guides [online] (2016). URL: http://www.ksg.harvard.edu/hepg/Papers/ETSO_EuroPEX_FMC_presentation.pdf
- [26] Central Western Europe Flow-Based Market Coupling (CWE FB MC): Electronic documents and on-line guides [online] (2016). URL: <http://www.amprion.net/sites/default/files/pdf/CWE%20-%20Com%20MP%2014.09.24%20VF.PDF>
- [27] CWE Enhanced Flow Based MC intuitiveness report - Discussion Paper: Electronic documents and on-line guides [online] (2016). URL: https://www.apxgroup.com/wp-content/uploads/2-CWE_FB-MC_intuitiveness_report_October-2013.pdf
- [28] Edwards, D., W.: Energy Trading and Investing: Trading, Risk Management and Structuring Deals in the Energy Market, ISBN-10: 0071629068
- [29] Biggar, R., D.: The Economics of Electricity Markets, ISBN-10: 1118775759
- [30] Harris, Ch.: Electricity Markets: Pricing, Structures and Economics, ISBN-10: 0470011580
- [31] Davino, C., Furno, M., Vistocco, D.: Quantile Regression: Theory and Applications, ISBN-10: 111997528X
- [32] Lingxin, H., Naiman, Q., D.: Quantile Regression, ISBN-10: 1412926289
- [33] Fitzenberger, B., Koenker, R., Machado, J., A., F.: Economic Applications of Quantile Regression, ISBN 3-7908-1448-2
- [34] Kumar, R.: Research Methodology: A Step-by-Step Guide for Beginners, ISBN-10: 1446269973
- [35] Stebbings, R., R.: Exploratory Research in the Social Sciences, ISBN-10: 0761923993
- [36] Aliaga, M., Gunderson, B.: Interactive Statistics, ISBN-10: 0131497561
- [37] Wind Energy and Electricity Prices, Exploring the ‘merit order effect’: Electronic documents and on-line guides [online] (2016). URL: <http://www.ewea.org/fileadmin/files/library/publications/reports/MeritOrder.pdf>
- [38] Raillon, P.: (CEER) Energy regulation and security of supply – the European regulators’ approach

- [39] National Renewable Energy Action Plan (NREAP) data from Member States: Electronic documents and on-line guides [online] (2016). URL: <http://www.eea.europa.eu/data-and-maps/figures/national-renewable-energy-action-plan>
- [40] Appunn, K.: Renewable EEG reform 2016 – switching to auctions for renewables: Electronic documents and on-line guides [online] (2016). URL: <https://www.cleanenergywire.org/factsheets/eeg-reform-2016-switching-auctions-renewables>
- [41] Metody vědecké práce; výběr metod vědecké práce pro zpracování ZP. Pracovní materiály Vysoká škola finanční a správní, 2010.
- [42] Metodologie vědecké práce. Masarykova univerzita, 2007.
- [43] Glachant, J., Lévêque, F.: Electricity Reform in Europe: Towards a Single Energy Market, ISBN-13: 978-1847209733
- [44] Sokolowski, M.: Regulation in the European Electricity Sector (Routledge Studies in Energy Law and Regulation), ISBN-13: 978-1138963412
- [45] ERGEG, ERI CEE - Congestion management, 2008
- [46] ACER, Framework Guidelines on Capacity Allocation and Congestion Management for Electricity : Electronic documents and on-line guides [online] (2016). URL: http://www.acer.europa.eu/en/electricity/fg_and_network_codes/electricity%20fg%20%20network%20codes/fg-2011-e-002.pdf
- [47] Eurelectric, The path from regional electricity markets to a pan-European market, Building a comprehensive EU market integration strategy: Electronic documents and on-line guides [online] (2016). URL: <http://www.eurelectric.org>
- [48] CEE Intraday Capacity Allocation and Nomination Procedure - The Trader Guide : Electronic documents and on-line guides [online] (2016). URL: <http://www.ceps.cz/>
- [49] Sokol, R., Bemš, J.: Balancing renewables on intraday electricity markets: Electronic documents and on-line guides [online] (2016). URL: <http://www.iaea.org/inis/collection/NCLCollectionStore/Public/43/130/43130966.pdf>
- [50] Platts, ACER recommends splitting German-Austrian power price bidding zone: Electronic documents and on-line guides [online] (2016). URL: <http://www.platts.com/latest-news/electric-power/london/acer-recommends-splitting-german-austrian-power-26218292>

- [51] Schildt, H.: Java: The Complete Reference, Ninth Edition, ISBN-13: 978-0071808552
- [52] Severance, Ch.: Python for Informatics: Exploring Information, ISBN-10: 1492339245
- [53] Yuan-Kang Wu, Jing-Shan Hong.: "A literature review of wind forecasting technology in the world," presented at 2007 IEEE Lausanne Power Tech Conf., pp.504-509.
- [54] Liu, Z., Gao, W.: Wind Power Plant Prediction by Using Neural Networks, National Renewable Energy Laboratory: Electronic documents and on-line guides [online] (2016). URL: <http://www.nrel.gov/docs/fy12osti/55871.pdf>
- [55] Ma, L., Luan, S.Y., Jiang, C.W., Liu, H L. and Zhang, Y.: A Review on the Forecasting of Wind Speed and Generated Power.: Electronic documents and on-line guides [online] (2016). URL: <http://dx.doi.org/10.1016/j.rser.2008.02.002>
- [56] Zhao, X., Wang, S. X. and Li, T.: Review of Evaluation Criteria and Main Methods of Wind Power Forecasting. Energy Procedia, 12, 761-769. Electronic documents and on-line guides [online] (2016). URL: <http://dx.doi.org/10.1016/j.egypro.2011.10.102>
- [57] Pena, R., Medina, A.: Using Neural Networks to Forecast Renewable Energy Sources.: Electronic documents and on-line guides [online] (2016). URL: https://www.researchgate.net/publication/260389687_Using_Neural_Networks_to_Forecast_Renewable_Energy_Resources
- [58] More, A., Deo, M.C.: Forecasting wind with neural networks.: Electronic documents and on-line guides [online] (2016). URL: <https://core.ac.uk/download/files/587/15681802.pdf>
- [59] Lingling Li., Minghui Wang, Fenfen Zhu, Chengshan Wang.: Wind Power Forecasting Based on Time Series and Neural Network, ISBN 978-952-5726-07-7
- [60] Frommel, M., Han, X., Kratochvil, S.: Modelling the daily electricity prices and their volatilities with realized measures. Energy Economics.: Electronic documents and on-line guides [online] (2014), ISSN 0140-9883 URL: <http://dx.doi.org/10.1016/j.eneco.2014.03.001>.
- [61] Knápek, J., Ajanovic, A., Haas, R.: Energy for Sustainable Development IV: Evidence from Czech and Austria, ISBN 978-80-7478-993-9
- [62] Fonte, M. P., Goncalo, X. S., Quadrado, J. C.: Wind Speed Prediction using Artificial Neural Networks, Proceedings of the 6th WSEAS Int. Conf. on NEURAL NETWORKS, Lisbon, Portugal, June 16-18, 2005 (pp134-139) .: Electronic documents and on-line

guides [online] (2016). URL: <http://www.wseas.us/e-library/conferences/2005lisbon/papers/496-JCQ4.pdf>

8 Publications

Sokol, R. - Bemš, J.: BALANCING RENEWABLES ON INTRADAY ELECTRICITY MARKETS. In 11th International Scientific Conference: Energy, Ecology, Economy 2012. Bratislava: Slovenská technická univerzita, 2012, vol. 1, art. no. 6, p. 95-96. ISBN 978-80-89402-49-6.

Mezera, J. - Martínek, Z. - Sokol, R.: Fundamental Approach for Day-Ahead Price Forecasting with Using Neural Networks. Acta Electrotechnica et Informatica. 2013, vol. 13, no. 2, art. no. 2, p. 8-12. ISSN 1335-8243.

Bemš, J. - Sokol, R. - Starý, O.: Vplyv rozmachu solárnej energetiky na cenu elektriny. In Proceedings of the 6th International Scientific Symposium on Electrical Power Engineering. Košice: Technická univerzita v Košiciach, 2011, s. 380-383. ISBN 978-80-553-0724-4.

Hrochová, M. - Bemš, J. - Králík, T. - Sokol, R.: RES integration impact on market environment in the Czech Republic. In POSTER 2014 - 18th International Student Conference on Electrical Engineering. Prague: Czech Technical University, 2014, ISBN 978-80-01-05499-4.

Sokol, R. - Bemš, J.: BALANCING RENEWABLES ON INTRADAY ELECTRICITY MARKETS. In 11th International Scientific Conference: Energy, Ecology, Economy 2012. Bratislava: Slovenská technická univerzita, 2012, p. 1-10.

Sokol, R. - Bemš, J. - Starý, O.: SOLAR BOOM IN CZECH REPUBLIC IN RELATION TO ELECTRICITY PRICES. In Proceedings of the 34th IAEE International Conference. Cleveland: IAEE, 2011, p. 1-16.

Adamec, M. - Bemš, J. - Králík, T. - Pavlátka, P. - Sokol, R. - et al.: Nové aspekty ovlivňující oblast výroby a obchodování s elektrickou energií III. [Výzkumná zpráva]. Praha: ČVUT FEL, Elektra, 2012. 9999. 104 s.

Adamec, M. - Bemš, J. - Pavlátka, P. - Sokol, R. - Starý, O. - et al.: Nové aspekty ovlivňující oblast výroby a obchodování s elektrickou energií II. [Výzkumná zpráva]. Praha: ČVUT FEL, Elektra, 2011. 9999. 79 s.