

**CZECH TECHNICAL UNIVERSITY IN
PRAGUE**



DOCTORAL THESIS STATEMENT

Czech Technical University in Prague
Faculty of Electrical Engineering
Department of Electromagnetic Field

Ing. Jan Eichler

MODAL APPROACH FOR ANTENNA DESIGN

Ph.D. Programme:
Electrical Engineering and Information Technology

Branch of study: Radioelectronics

Doctoral thesis statement for obtaining the academic title
of "Doctor", abbreviated to "Ph.D."

Prague, March 2014

The doctoral thesis was produced in full-time manner Ph.D. study at the department of electromagnetic field of the Faculty of Electrical Engineering of the CTU in Prague

Candidate: Ing. Jan Eichler

Department of Electromagnetic Field
Faculty of Electrical Engineering of the CTU in Prague
Technická 2, 166 27 Prague 6

Supervisor: Doc. Ing. Pavel Hazdra, Ph.D.

Supervisor specialist: Prof. Ing. Miloš Mazánek, CSc.

Department of Electromagnetic Field
Faculty of Electrical Engineering of the CTU in Prague
Technická 2, 166 27 Prague 6

Opponents:

The doctoral thesis statement was distributed on:

The defence of the doctoral thesis will be held on at a.m./p.m. before the Board for the Defence of the Doctoral Thesis in the branch of study Radioelectronics in the meeting room No. of the Faculty of Electrical Engineering of the CTU in Prague.

Those interested may get acquainted with the doctoral thesis concerned at the Dean Office of the Faculty of Electrical Engineering of the CTU in Prague, at the Department for Science and Research, Technická 2, Praha 6.

Chairman of the Board for the Defence of the Doctoral Thesis
in the branch of study Radioelectronics
Faculty of Electrical Engineering of the CTU in Prague
Technická 2, 166 27 Prague 6

1 Current Situation of the Studied Problem

Effective numerical analysis of radiating structures has been a relevant topic over the last few decades and applications are constantly being developed as wireless communications become increasingly popular. For large and complex structures, methods which can separate the independent effects of particular parts of a high-frequency device, or provide deeper understanding of physical principles are of great interest. One class of such methods are the modal methods.

The concept of characteristic modes was developed by Garbacz and Turpin [1, 2, 3], who showed that it is possible to expand the fields radiated or scattered by a surface S , made from the perfect electric conductor (PEC), into a set of eigenfunctions (characteristic modes). The key properties of these modes are that they are real (equiphase) on the surface, orthogonal with respect to the radiated power, and only a few modes are usually necessary to characterize the radiated or scattered fields with sufficient accuracy. The theory was formulated from an alternative viewpoint by Harrington and Mautz [4], whose approach is to diagonalize the electric field integral equation (EFIE) operator.

Increased interest in the practical application of TCM is observed in journal articles published in the last 10 years. The work [5, 6] showed advantages of modal approach in antenna design, particularly for circularly polarized antennas, multiple-input multiple-output (MIMO) antennas, electrically small antennas (ground plane radiation) as well as wire antennas and reflectarrays.

Application of the TCM on an ultra-wideband (UWB) antenna design was studied in [6] and based on the modal approach a two-feed rectangular UWB monopole with increased bandwidth was proposed, manufactured and measured. Characteristic modes (ChM) were fully utilized in the design of the UWB monopole antenna with a tunable notched band functionality [7]. A multiple feed approach was found especially useful for circularly polarized antennas, where a combination of two orthogonal modes is necessary, and for MIMO antennas to achieve low correlation of received signals.

The suitability of TCM for fractal antenna analysis and design was studied in [8]. The TCM was also compared with the cavity model (CM) and it was concluded that CM is quite efficient for computing a large number of modes despite its limited accuracy mostly due to approximations considered in the CM formulation. On top of that, TCM eigenvalues provide additional information regarding the physical behavior of the radiating surface, thus, TCM is the preferred modal method. The L-probe feeding mechanism used for broad-banding a planar antenna, including the equivalent circuit model, is well described in [8]. Radiation efficiency was studied in terms of characteristic modes in [9, 10], however, since the skin effect was not included, the accuracy of the method was limited.

The ongoing question is the dominance of the modes which determine how modes contribute to the overall performance. Several modal significance measures were proposed

to address the issues. First, the smaller the magnitude of the eigenvalue itself - which corresponds to the ratio of net reactive power to radiated power - the better a mode radiates energy [4].

The next proposed measure is the modal significance which represents normalized current amplitude [5, 11]. The significance measure proposed in [12] represents the case of each mode being excited in the region of its maximal amplitude.

The radiation quality factor, in terms of characteristic modes, was studied in [13] and more extensively in [14] and [15]. The latter work specializes in the coupled usage of characteristic modes and the theory of matching networks to improve antenna bandwidth. The work concludes that characteristic modes are responsible for series resonance while a combination of two ChM is necessary to create a parallel resonance. It was also found that an ideal broadband matching network should have a negative slope of reactance against frequency. Consequently, non-Foster elements were investigated as the most appropriate loads [15].

Radiation and coupling modes (different from characteristic modes) were defined on sub-structures in [16]. The newly defined modes can be used to optimize coupling between several structures which influence each other. The method was demonstrated on coupled dipoles and a Yagi-Uda antenna with 3 and 6 elements. The drawback of the approach is the necessity of performing two decompositions and mapping the coupling and radiation modes to each other. A similar idea, with different goals and consequences, is to define sub-structure modes [17, 14] whose advantage lies in their ability to optimize a part of the antenna which can be accessed by an excitation.

After the modes are computed for a radiating structure, the excitation of desired modes have to be considered. To widen antenna bandwidth, an L-probe feeding mechanism, which can be regarded as a type of proximity coupled element, was investigated in [8]. Electrically small antennas, such as PIFA or small cubes mounted on a PCB, can be considered as feeding geometries [6, 18, 19]. Specialized feeding (or coupling) structures were developed to excite PCB modes [20] and utilized to design a MIMO antenna with reduced channel correlation [21].

Papers on numerical aspects of characteristic modes are more uncommon. Mode tracking algorithms connect the modes computed at different frequencies and are of high value for broadband modal analysis [22, 23].

The most recent papers are dedicated to the reconstruction of characteristic modes from a far-field pattern [24]. Another recent paper is focused on the creation of an equivalent circuit model from characteristic modes and eigenvalues [25]. An advantage of the model is that broadband behavior of input impedance as well as of antenna radiation can be extracted. Rather than a series RLC circuit, the paper uses a high pass circuit of different orders to model broadband behavior of eigenvalues. The theory was tested on a dipole and rectangular patch antenna.

2 Aims of Disertation

The general aim of the thesis is to contribute to the theoretical as well as practical knowledge of the theory of characteristic modes. The particular goals are specified as:

- To use the TCM for practical patch antenna design and study physical properties, especially resonant frequencies and the quality factor of patch antennas through modal decomposition. Part of this goal is to pinpoint the limitations and fields of possible study for the rest of the thesis.
- To outline the possibilities of using characteristic modes for an active differentially fed antenna design.
- To contribute to the development of an in-house modal analyzer. More specifically to develop a mesh generation tool which will enable further research of the numerical aspects of characteristic modes computation.
- To study the effect of mesh density on modal results and to give recommendations for mesh refinement strategy.
- To study the principle of exciting characteristic modes and to develop a method for determining an excitation coefficient for a scatterer coupled to a particular feeding geometry.

3 Working Methods

The first part of the dissertation is practically oriented. Using the TCM, a compact dual band antenna with a self-affine U fractal motif is developed. A dual L-probe feeding mechanism is proposed to excite the desired modes in the two bands of interest and to match the antenna. Next practical part is dedicated to an active printed dipole antenna with a very low equivalent noise temperature and a natural suppression of common mode noise. The work has been conducted in cooperation with the group of Prof. Daniel Segovia-Vargas of Carlos III University of Madrid. Both the dual band antenna and active differential antenna were manufactured, measured and compared to the simulation.

Analysis of modal resonant frequencies and the quality factor of chosen planar motifs was conducted using the in-house modal analyzer [26, 27]. This part utilizes expressions for radiation quality factor [28] and builds on the results published in [29].

After completing the prototype of active antenna, it was intended to use the TCM to modify its passive part. The goal was found to be problematic to achieve, since the input impedance of the passive part plays a crucial role in the design. It has to be optimized to ensure wideband stability of the amplifier for both the common and differential modes. Moreover, tuning the input impedance of the passive part can significantly improve its equivalent noise temperature and gain [30]. To be able to benefit from modal analysis, a method for effective recalculation of the input impedance for different position of antenna excitation is necessary.

As in other methods, mesh plays a crucial role in TCM since it influences both the speed of a simulation and its accuracy. Therefore a tool for surface mesh generation in MATLAB called MeshGen was developed and the influence of mesh density on modal properties was studied. Consequently, a simple error analysis considering the effects of quadrature errors on the numerical computation of characteristic modes by the method of moments was conducted. The theory has been tested on the dominant mode of a dipole, a rectangular patch, and a rectangular patch with a slot. Convergence curves for resonant frequency, Q_{eig} and maximal directivity for different mesh refinement schemes have been compared.

One of the important features of TCM is the possibility of summing the modes to obtain the total current as it would be computed by the direct solution of the electric field integral equation. Summation formulas for antenna parameters such as radiation pattern or input admittance are available when the excitation electric field is defined. The formulas are however valid only on condition that the structure does not change. Thus it is the purpose of the last part of the thesis, to review the mechanism of the excitation of characteristic modes and to propose a technique for determining excitation coefficients for particular feeding geometry, which will enable fast evaluation if the geometry is moved.

4 Results

Design of a Dual-Band Orthogonally Polarized L-Probe-Fed Fractal Patch Antenna Using Modal Methods

Based on previous experience, the fractal published in [31] was chosen as a potential candidate and will be called SAU (Self-affine 'U'). Modal analysis and the first prototype were the object of author's master's thesis [32]. Further simulations and improvements from the construction point of view were necessary to obtain a very good agreement between the simulation and the measurement of both S-parameters and radiation pattern cuts.

The SAU fractal is created from a rectangle by 4 parameter dependent IFS transformations. Modal analysis revealed that modes 1 and 2 radiate in a normal direction if the motif resembles the letter 'U'. Orthogonality of polarizations could easily be explained by inspecting the dominant current lines for modes 1 and 2 in Fig. 1.

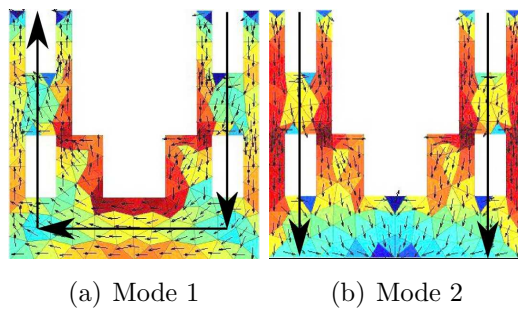

Figure 1: Surface current on the second iteration SAU motif (TCM).

According to a parametric study of the SAU fractal, it is possible to achieve the ratio f_2/f_1 of modal resonant frequencies to be approximately 1.6 - 3.5 (cavity model simulation). The main influence on f_2/f_1 has the ratio of the patch width to its length because the major part of the mode 1 current is orientated in the X axis direction and mode 2 forms a standing wave in the Y axis direction (Fig. 1).

The second iteration SAU fractal motif was chosen as a compromise between low resonant frequency and low modal quality factor. Modes 1 and 2 satisfy the demand on low resonant frequency and normal radiation. The selected motif is considerably electrically small ($0.208 \times 0.208 \lambda$ at f_1), therefore the fractional bandwidth FBW is quite narrow. To compensate this effect, the patch is placed high enough above the ground plane and fed by an L-probe which acts also as a matching circuit. The optimal L-probe length and bend position is different in both bands [34], thus a modification leading to the dual L-probe (DL-probe) was proposed.

The current density in both bands is concentrated on specific and more or less independent parts (arms) of the DL-probe. This allows us to design the arms separately for

each working band. An overall view of the CST model with the actual orientation of the DL-probe is shown in Fig. 2.

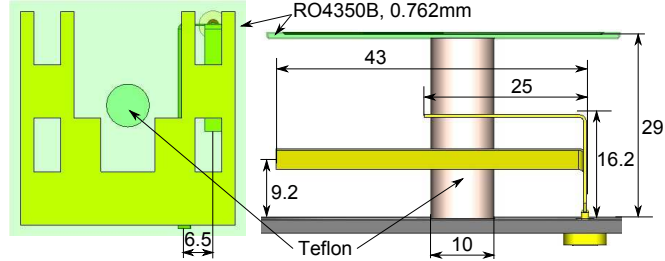
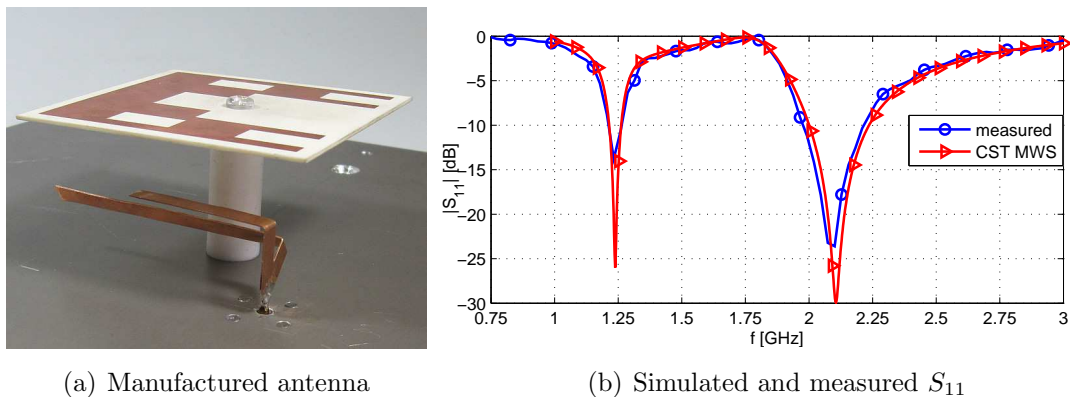

Figure 2: Second iteration SAU, CST model with dimensions in mm.

The proper feeding position can be guessed from the current density computed by the TCM. The horizontal part of the DL-probe arm should be orientated parallel to the modal current on the patch surface (see Fig. 1 and Fig. 2).

The simulated and the measured S_{11} are in very good agreement, Fig. 3(b). In the lower band the motif dimensions are $0.208 \times 0.208 \lambda$ which leads to quite a narrow bandwidth. This disadvantage was partially compensated by using DL-probe feeding, which allows 10 dB FBW to be 4.18%. The motif is electrically larger in the higher band ($0.34 \times 0.34 \lambda$), therefore the situation is easier and the measured FBW is 11.4%.

The antenna feeding is optimized to maximal bandwidth in the lower band. However, by changing dimensions of the DL-probe an antenna with the $\text{FBW}_{\text{lower}} = 3.42 \%$ and the $\text{FBW}_{\text{upper}} = 18.7 \%$ was designed in the CST MWS. Due to unbalanced feeding, the radiation pattern is distorted and the maximal directivity is slightly (5° and 8°) shifted from the normal direction. Radiation pattern measurement confirmed mutually orthogonal polarizations in both bands.



(a) Manufactured antenna

(b) Simulated and measured S_{11}

Figure 3: Realized antenna prototype.

Radiation Quality Factor and Modal Resonant Frequency

Further studies of modal properties of chosen motifs over an infinite PEC plane were made, using a rigorous expressions for radiation Q_J derived in [28]. The chosen motifs were: a rectangle, a SAU fractal in the first and the second iteration and a fractal clover leaf (FCL) motif. Several important observations were made: the difference between the Q_J computed from modal currents and the Q_{eig} computed from the slope of the characteristic number is less than 1%, providing, that the triangles are small compared to the height over the finite ground. Next it was confirmed on the SAU and FCL motifs that opposing currents increases the radiation quality factor. It was also observed that the resonant frequency of the dominant rectangular patch mode is quite complicated function of height for air substrates thicker than approx. 0.5λ . Finally it was observed that the resonant frequency of the low- Q modes is much more sensitive to the substrate height than of the high- Q modes.

Consider a rectangular patch antenna of dimensions $L = 50$ mm, $W = 30$ mm (further noted as R50x30) placed in air above an infinite ground plane. Only the dominant mode will be studied. Using the image theory, the radiator in the XY plane at height $z = H$ above an infinite electric ground plane is modeled as two patches separated by $2H$. In the TCM analyzer, a proper out-of-phase mode is selected (Fig. 4(a)). The resonant frequency of the dominant mode is shown as a function of height H , see Fig. 4(b). The behaviour is quite peculiar, especially for greater heights. For low heights ($H < 10$ mm or $H/\lambda_{\text{res}} < 0.08$), the resonant frequency decreases “regularly” and quasi-analytical formulas (see e.g. [35, 36]) based on the fringing field concept are valid below this range.

The studies showed, that microstrip antennas support different kinds of modes regarding their Q factors:

- a) Low- Q modes with the current flowing in one direction and not changing its phase (dominant modes of simple shapes like rectangular, circular patch etc..)
- b) High- Q modes with part of the currents flowing in the opposite direction. These modes exist even on simple “U” shaped patch and on complex (fractal) geometries.

It has been observed that resonant frequency is quite a complicated function of height. Looking at Fig. 5 it is clear (and interesting) that the resonant frequency behaves quite differently for low- Q and high- Q modes. The resonant frequency of low- Q modes is much more sensitive to the height, whereas high- Q modes exhibit almost constant f_r when the height is varied. The proposed explanation is that the opposite currents (responsible for high Q) keep reactive fields very close to the radiating structure so the effect of a fringing field coupled to the ground plane becomes almost negligible.

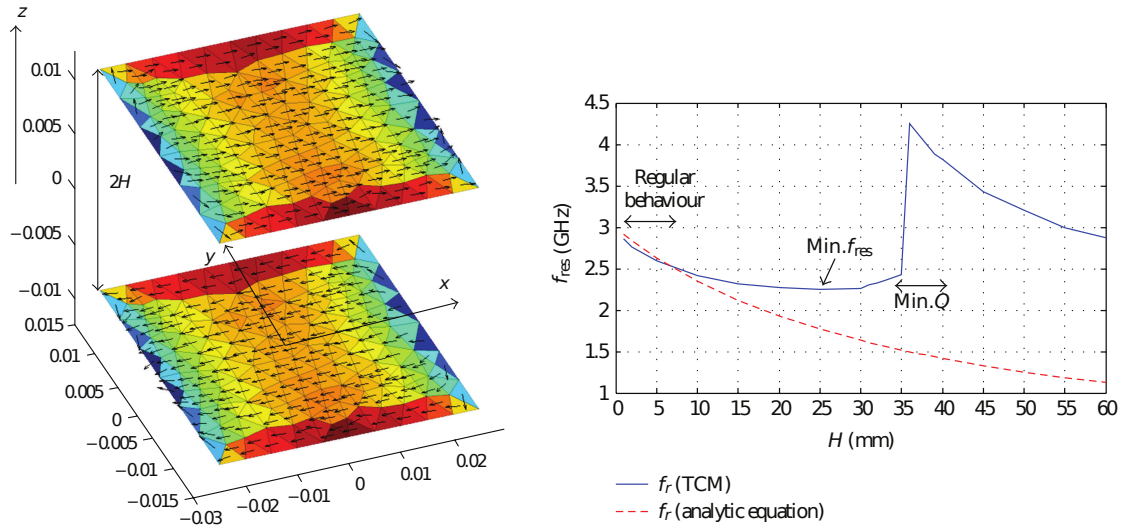

(a) Model of MPA above infinite ground plane for $H = 10$ mm, dominant mode. (b) R50x30 resonant frequency of the dominant mode. The dashed red curve is a quasi-analytical equation

Figure 4: Model of MPA above infinite ground plane for $H = 10$ mm, dominant mode.

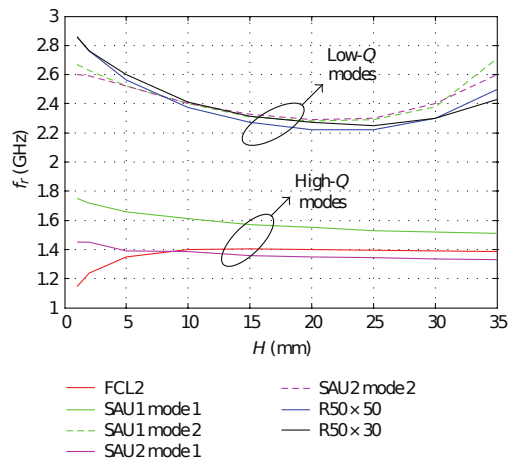

Figure 5: Resonant frequencies for different antennas / modes.

Active Differential Antenna

An active printed dipole antenna with a very low equivalent noise temperature and a natural suppression of common mode noise will be described next. The active part of the antenna is a single stage differential amplifier. The amplifier is studied in terms of the mixed-mode S-parameters. The goal of the design process is a low noise unconditionally stable amplifier with as high gain as possible. The amplifier will be directly connected to the printed dipole antenna. Since both the passive and the active parts have the differential topology there is no need for symmetrization or conversion to the single ended mode. This is quite beneficial for low noise applications because symmetrization circuit represents a loss connected to the input of the amplifier. Other benefit is reduction of circuit size. It is necessary to ensure both the common and the differential mode amplifier stability. The stability criteria used is the geometrical stability factor μ [37]. The proposed amplifier has a fully differential topology which results in a reduction of common mode noise and a high common mode rejection ratio (CMRR) [30]. The amplifier was designed with AWR Microwave Office [38].

The simulated differential gain of the proposed amplifier is S_{21dd} is higher than 11.2 dB and the common mode gain is lower than -22.97 dB (from 1.7 to 2.6 GHz). This means that the CMRR is at least 34.17 dB. The noise figure predicted by the simulation is better than 0.73 dB (equivalent noise temperature smaller than 53 K) for ideally matched amplifier input i.e. 100Ω differential load. For the actual antenna the amplifier noise figure is smaller than 2 dB (T_e is smaller than 169 K in the whole frequency range). The S_{21dd} with the simulated dipole load is higher than 10 dB. The simulated S_{11} of the active antenna was obtained by importing the S_{11} of the dipole in to AWR and using it as an input load for the amplifier. The return loss is better than 10 dB in the band of interest (1.7 - 2.6 GHz) which means that relative bandwidth is at least 41.86%.

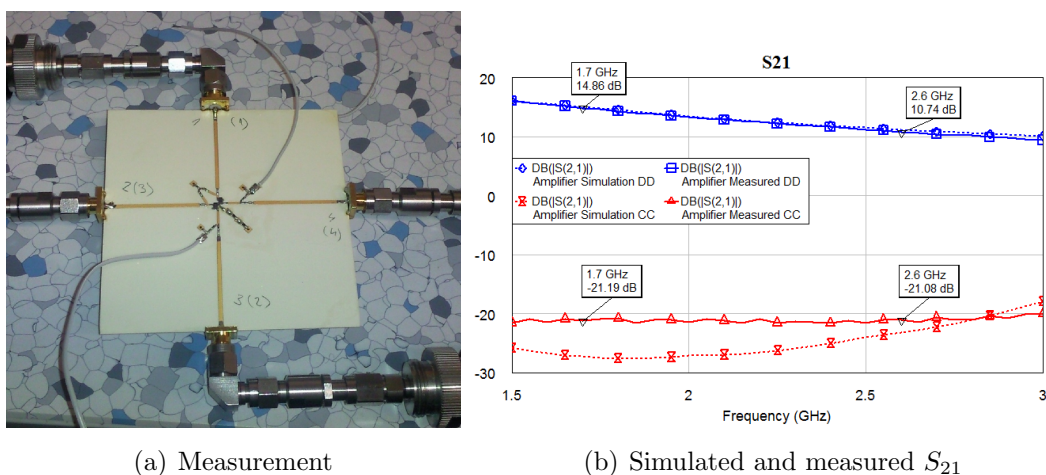

Figure 6: Differential amplifier.

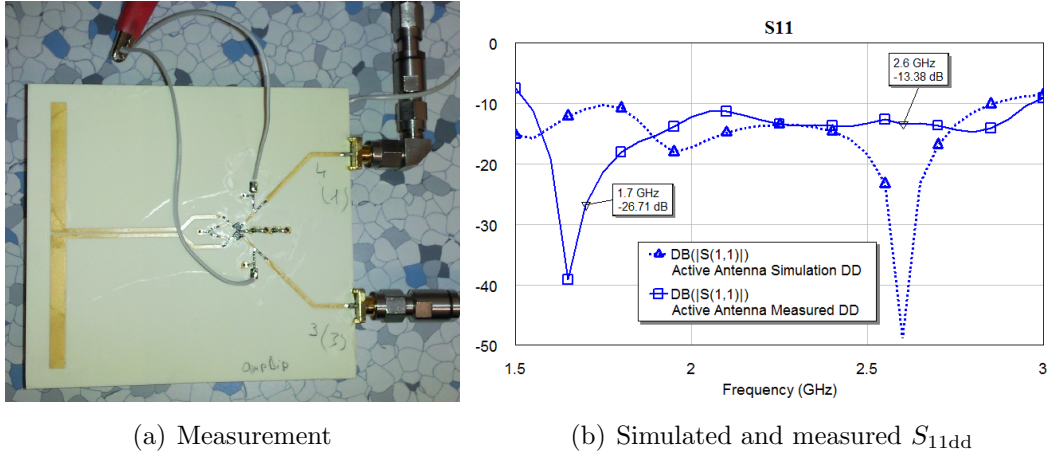

Figure 7: Active antenna.

The amplifier and the active antenna were manufactured and measured; the prototypes are in Fig. 6, 7. The mixed mode S-parameters were obtained in a true differential measurement with Rohde and Schwarz ZVA 67. The measured S_{21dd} is in a very good agreement with the simulation - the discrepancy is less than 0.5 dB, Fig. 6. The measured CMMR is a little lower than predicted (at least 31.8 dB), which is still a very good value. There is a difference in S_{11} of the active antenna prototype, Fig. 7, however it is below -10 dB in the band of interest.

Mesh Generation for TCM

Characteristic modes can be numerically calculated by the method of moments. As in other methods, mesh plays a crucial role in TCM since it influences both the speed of a simulation and its accuracy. A tool called MeshGen was developed in MATLAB to easily define and parametrize geometry and generate its surface mesh. A suitable algorithm for mesh generation is distmesh [39]. It allows full mesh control (fixed points, mesh density control), but the biggest advantage is that it is simple to understand and to integrate into the in-house tools. The improvements to the basic MATLAB code [39] have been implemented to increase the convergence of the algorithm to a high quality mesh, as well as algorithm robustness.

A convergence study of modal resonant frequency $f_{res,n}$, modal radiation quality factor and maximal modal directivity with mesh density was conducted next. Convergence studies are necessary to eliminate the effect of the error cancellation mechanism [41], which can be observed if several sources of error eliminate each other and the result thus appears to be accurate. Results from FEKO software using a relatively fine mesh and basis functions denoted as order 2.5 were chosen as a reference.

The integrals involved in calculating of the elements of impedance matrix are usually

evaluated by numerical quadrature and thus contain errors. It is expected that these errors will be smaller with (electrically) smaller triangles, i.e. with higher mesh density. The effect of these errors on eigenvalue was derived considering the symmetry of Hermitian parts of the impedance matrix and applying the result from [40]. Then the derivations were tested by convergence studies for non-uniformly refined meshes.

In order to compare different mesh refinement schemes for different structures, we use the number m , associated with each mesh, which has the meaning of the number of smallest edges per wavelength. Meshes will be generated using MeshGen requiring the same minimal triangle quality. The convergence was studied on a strip dipole, a rectangular patch, a U shaped patch, and a circularly polarized triangular patch.

Consider a rectangular patch in free space. It can be seen that the current density of the first mode is spread over the patch, Fig. 8. Convergence of the uniformly refined mesh was generally better than the locally refined mesh. The exception was the scenario denoted as V01, in which the mesh was coarser in the regions with high magnitude of current density, Fig. 8. This paradoxical behavior can be explained as follows. The two edges of the patch are discretized by bigger triangles, thus the corresponding current density is lower, see Fig. 8. This means that these big triangles (with bigger error) become less significant for computation of the eigenvalue. In other words, the eigenvalue will be more affected by smaller triangles with smaller error, which is in accordance with the simple error analysis.

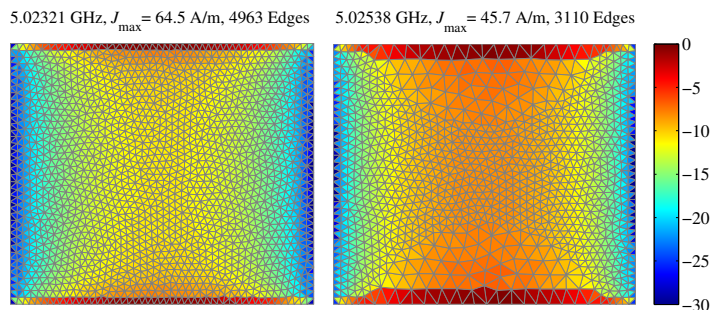

Figure 8: First mode of a rectangular patch 3 mm above ground plane at its resonance, uniformly refined mesh (left) and V01 refined mesh (right). A normalized logarithmic scale is used for both cases.

The next structure is the same patch with a slot. The dominant mode has a very localized current density, Fig. 9, thus it is ideal for applying a non uniform mesh refinement scheme. To observe the differences between a properly refined mesh and an ineffective refinement, two schemes were proposed. Meshes that are properly refined in the regions with high amplitude of the modal current density are denoted as V01, Fig. 9. By contrast, the scheme denoted as V02 is not refined near the maximum of the current, see Fig. 9, and is ineffective from the error minimization point of view.

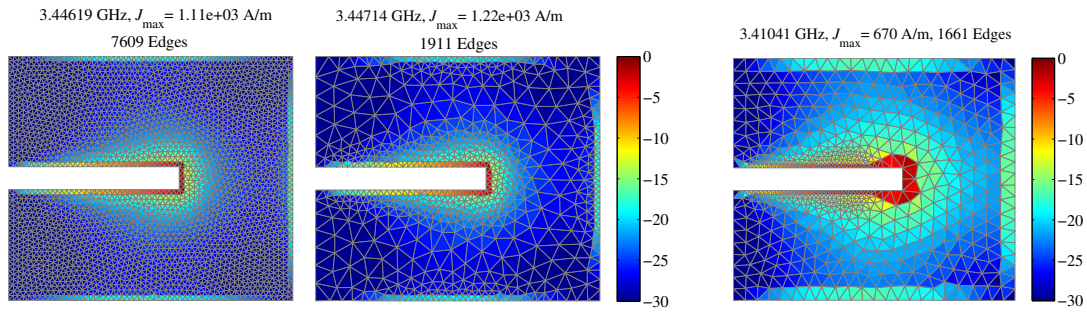

Figure 9: First mode at its resonance, uniformly refined mesh (left), V01 mesh (middle), and V02 mesh (right), normalized logarithmic scale.

The slow convergence of V02 is clearly visible in Fig. 10. On the other hand, the V01 results are very close to Uni with similar minimal edge length. Note that the total number of edges, which directly influences the simulation speed, is reduced approximately by a factor of 3-4 for the V01 mesh. Therefore computing 6 frequencies took 9.25 minutes and 1 minute for the uniform and V01 structures of Fig. 9, respectively. The nice speedup of 9.25 is interesting, especially for an optimization.

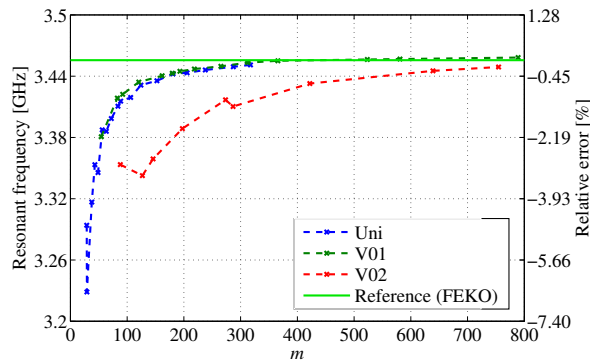

Figure 10: Convergence of resonant frequency of the patch with a slot for different refinement schemes.

Generally, it was observed, that the computation of characteristic modes by in-house MoM converges with an increased number of basis functions (we suppose that the round off errors were insignificant for all presented computations). However, no rule of thumb for number of basis functions per wavelength for a given relative error has been deduced. Modal radiation quality factor tends to be the most sensitive parameter, and needs careful choice of the mesh.

The recommendations for mesh refinement have been tested on a circularly polarized patch in the in-house tool and also in FEKO (using low order basis functions). Although they were slightly different in absolute values, which may be due to approximations in the

in-house tool, the results were qualitatively equivalent and preserved the same trends.

Excitation of Characteristic Modes

It is implied by the definition of characteristic modes, that they are computed without an excitation, which is represented by an arbitrary impressed field \mathbf{E}^i . It has to be noted, that once the geometry, on which current density can flow, is changed, the modes will change as well.

The method determining a coupling between individual characteristic modes on a planar structure was derived next. The individual structure at free space will be denoted as a *scatterer* and several coupled scatterers will be called a *system of scatterers* (or simply a system). The terms scatterer and system of scatterers in this sense was adopted from [14], where they were used to describe a sub-structure modes. Note, however, that here both scatterers may be excited, but it is assumed, that they are not electrically connected.

The derivations lead to a moment matrix equation to be solved for known excitation vector. Considering the orthogonality properties of characteristic modes, we find a simple relations for the elements of the moment matrix, if the modes are located on the same scatterer. The elements corresponding to modes on different scatterers have to be computed numerically. However, there is no singularity in the integral kernel of the elements.

The result of the described procedure is a vector of modal expansion coefficients, thus if the modes expansion vector in is known, the port current I_{in} can be computed. Interestingly, characteristic modes of entire system can be reconstructed from the modes of individual scatterers as well.

If the structure is changed, only the matrix elements for different scatterers need to be recalculated and impedance matrix inverted. It is interesting to note, that storage requirements for characteristic modes of a scatterer are much smaller than storage requirements of a scatterer's impedance matrix. The developed methods of obtaining direct solution and characteristic modes will be called ChMBF¹ method.

To validate the method, consider a rectangular patch excited by a strip L-probe over an infinite PEC plane, [8]. Using the method of images, the geometry will be modeled in a mirrored configuration², Fig. 11(a).

In this particular example, only one mode on the probe and one mode on the patch is sufficient to approximate the S_{11} , see Fig. 11(b). Note, that the coupling between the two structures plays important role, and is properly taken into account.

Excitation of higher order modes, together with a strong coupling between the structures may become a challenging problem for ChMBF method. Therefore the second

¹Characteristic modes as basis functions.

²The mirrored configuration is chosen because the in-house tool currently does not support meshes touching the infinite PEC plane.

161 Edges, 136 Triangles, $\min(L)=2$ mm,
 $\text{mean}(L)=8.64$ mm, $\max(L)=14.5$ mm

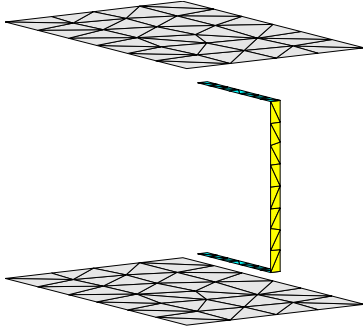

(a) Mesh

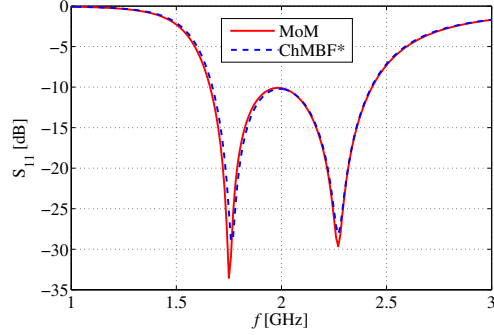

(b) S_{11} computed by a direct moment solution of EFIE and by ChMBF method. The reference impedance for S-parameters is 100Ω . One mode on the patch and one mode on the probe was used (denoted as ChMBF*).

Figure 11: Mirrored configuration of a rectangular patch, excited by an L-probe.

considered example is the second iteration SAU fractal motif from Fig. 1, closely coupled to an asymmetrically placed L-probe. The gap between the motif and the probe is 1 mm (0.0083 wavelengths at 2.5 GHz), Fig. 12(a). Moreover the probe is placed asymmetrically and provides a localized coupling, which will excite higher order modes of the self-affine motif.

185 Edges, 176 Triangles, $\min(L)=2$ mm,
 $\text{mean}(L)=6.89$ mm, $\max(L)=13$ mm

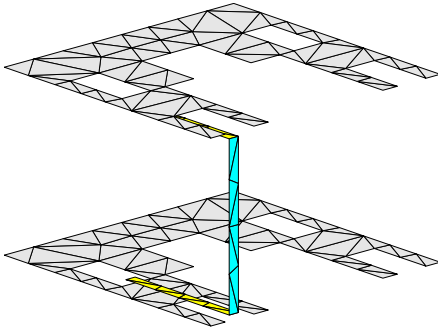

(a) Mesh

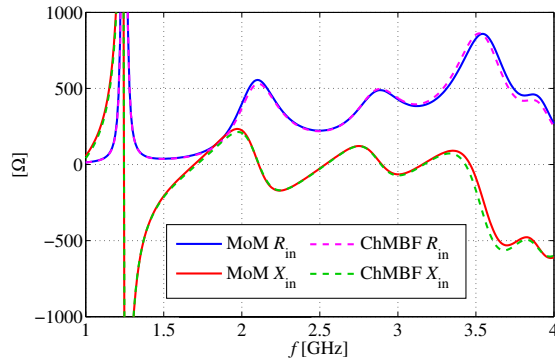

(b) Input impedance computed by a direct solution of EFIE and by ChMBF method using all numerically obtained modes.

Figure 12: Mirrored configuration of a SAU motif, excited by an L-probe.

The magnitude of the difference between RWG MoM and proposed method is quite small, Fig. 12(b), thus it is probably due to finite numerical precision. Note, that the impedance is a nontrivial function of frequency, which confirms, that several modes are

strongly contributing to the antenna performance in the selected frequency range.

The ChMBF method can be used to investigate the effect of a height of a planar motif over an infinite PEC or PMC³ plane. These two cases are computed at once if the structure is mirrored over XY plane. There exist two solutions of the discretized eigenvalue equation which represents the in-phase and out-of-phase currents. Associated with these two eigenvectors are the eigenvalues, and corresponding eigenangles, plotted in Fig. 13. It can be seen that the eigenvalues of a mirrored mode oscillate about the eigenvalue of the mode in free space. With the increased height, more oscillations with smaller amplitude are observed within a fixed frequency range.

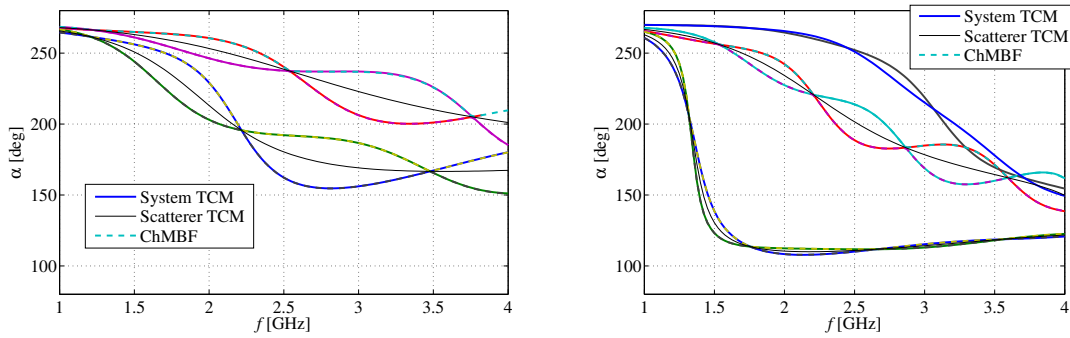

(a) Rectangular patch, $H = 50$ mm.

(b) SAU, $H = 90$ mm.

Figure 13: Eigenangles of the mirrored configuration of scatterers.

It is intuitively expected, that the oscillations are caused by the evolution of coupling between the two modes with height. Using ChMBF, the coupling may be computed in terms of the off-diagonal terms of the modal impedance matrix. It seems, that the oscillations occur independently on the current distribution, at least for the first two modes of a rectangular patch and the SAU motif. It is therefore possible to address the behavior of the modal resonant frequency in Fig. 4(b) to the evolution of coupling, which for certain heights causes a very high sensitivity of f_{res} on H .

³Perfect magnetic conductor.

5 Conclusion

The most important contributions of the thesis are listed below:

- Designing a dual-band fractal antenna using the modal information and proposing a dual L-probe to match the antenna simultaneously in both bands, journal paper [33].
- Designing an active differentially fed antenna with a very low equivalent noise temperature, high CMMR, and wide bandwidth, conference paper [42].
- Explaining the effects of current distribution and height over an infinite PEC plane on resonant frequency and radiation quality factor of high- Q and low- Q modes through modal decomposition, journal paper [43].
- Developing a versatile surface mesh generation tool for the in-house modal analyzer, journal paper [44] (in review).
- Analyzing the effects of quadrature errors on the numerical computation of characteristic modes by the method of moments, journal paper [44] (in review).
- Formulating recommendations for a mesh refinement strategy, based on the error analysis, which have been verified in the in-house tool, as well as in the commercial FEKO package, journal paper [44] (in review).
- Deriving the ChMBF method for computing coupling coefficients between modes of individual scatterers.

References

- [1] R. Garbacz, “Modal expansions for resonance scattering phenomena,” *Proceedings of the IEEE*, vol. 53, no. 8, pp. 856–864, Aug 1965.
- [2] R. J. Garbacz, “A generalized expansion for radiated and scattered fields,” Ph.D. dissertation, The Ohio State Univ., 1968.
- [3] R. J. Garbacz and R. H. Turpin, “A generalized expansion for radiated and scattered fields,” *IEEE Trans. Antennas Propag.*, vol. 19, no. 3, pp. 348–358, May 1971.
- [4] R. F. Harrington and J. R. Mautz, “Theory of characteristic modes for conducting bodies,” *IEEE Trans. Antennas Propag.*, vol. 19, no. 5, pp. 622–628, Sept. 1971.
- [5] M. Cabedo-Fabres, E. Antonino-Daviu, A. Valero-Nogueira, and M. F. Bataller, “The theory of characteristic modes revisited: A contribution to the design of antennas for modern applications,” *IEEE Antennas Propag. Magazine*, vol. 49, no. 5, pp. 52–68, Oct. 2007.
- [6] M. Cabedo-Fabres, “Systematic design of antennas using the theory of characteristic modes,” Ph.D. dissertation, UPV, Feb. 2007.
- [7] E. Antonino-Daviu, M. Cabedo-Fabres, M. Ferrando-Bataller, and V. M. R. Penarrocha, “Modal analysis and design of band-notched UWB planar monopole antennas,” *IEEE Trans. Antennas Propag.*, vol. 58, pp. 1457–1467, 2010.
- [8] P. Hazdra, “Planarni fraktalove antenni struktury,” Ph.D. dissertation, CTU in Prague, 2009, (in czech).
- [9] P. Hamouz, P. Hazdra, M. Polivka, M. Capek, and M. Mazanek, “Radiation efficiency and Q factor study of franklin antenna using the theory of characteristic modes,” in *Proceedings of the 5th European Conference on Antennas and Propagation (EUCAP)*, Rome, Italy, April 2011, pp. 1974–1977.
- [10] P. Hamouz, M. Polivka, and P. Hazdra, “Efficiency treatment of two closely spaced metal sheets by characteristic mode theory,” in *Antennas and Propagation, 2009. EuCAP 2009. 3rd European Conference on*, March 2009, pp. 178–181.
- [11] B. A. Austin and K. P. Murray, “The application of characteristic-mode techniques to vehicle-mounted NVIS antennas,” *IEEE Antennas Propag. Magazine*, vol. 40, pp. 7–21, 1998.
- [12] J. Ethier and D. A. McNamara, “Modal significance measure in characteristic mode analysis of radiating structures,” *Electronics Letters*, vol. 46, no. 2, pp. 107–108, Jan. 2010.
- [13] —, “Through the looking glass: A characteristic mode view of electromagnetic modeling & design,” in *ANTEM-AMEREM*, July 2010, pp. 1–4.
- [14] J. Ethier, “Antenna shape synthesis using characteristic mode concepts,” Ph.D. dissertation, University of Ottawa, 2012.

- [15] K. A. Obeidat, “Design methodology for wideband electrically small antennas based on the theory of characteristic modes,” Ph.D. dissertation, Univ. of Illinois, 2010.
- [16] B. D. Raines, “Systematic design of multiple antenna systems using characteristic modes,” Ph.D. dissertation, The Ohio State University, 2011.
- [17] J. Ethier and D. McNamara, “Sub-structure characteristic mode concept for antenna shape synthesis,” *Electronics Letters*, vol. 48, no. 9, pp. 471–472, April 2012.
- [18] E. A. Daviu, “Analysis and design of antennas for wireless communications using modal methods,” Ph.D. dissertation, UPV, Feb. 2008.
- [19] A. Andujar, J. Anguera, and C. Puente, “Ground plane boosters as a compact antenna technology for wireless handheld devices,” *IEEE Trans. Antennas Propag.*, vol. 59, no. 5, pp. 1668–1677, 2011.
- [20] R. Martens, E. Safin, and D. Manteuffel, “Inductive and capacitive excitation of the characteristic modes of small terminals,” in *Loughborough Antennas & Propagation Conference*, 2011.
- [21] R. Martens, J. Holopainen, E. Safin, J. Ilvonen, and D. Manteuffel, “Optimal dual-antenna design in a small terminal multiantenna system,” *IEEE Antennas Wireless Propag. Lett.*, vol. 12, pp. 1700–1703, 2013.
- [22] B. D. Raines and R. G. Rojas, “Wideband characteristic mode tracking,” *IEEE Trans. Antennas Propag.*, vol. 60, no. 7, pp. 3537–3541, July 2012.
- [23] M. Capek, P. Hazdra, P. Hamouz, and J. Eichler, “A method for tracking characteristic numbers and vectors,” *PIER-B*, vol. 33, pp. 115–134, 2011.
- [24] E. Safin and D. Manteuffel, “Reconstruction of the characteristic modes on an antenna based on the radiated far field,” *IEEE Trans. Antennas Propag.*, vol. 61, pp. 2964–2971, 2013.
- [25] J. J. Adams and J. T. Bernhard, “Broadband equivalent circuit models for antenna impedances and fields using characteristic modes,” *IEEE Trans. Antennas Propag.*, vol. 61, no. 8, pp. 3985–3994, 2013.
- [26] M. Capek, P. Hazdra, P. Hamouz, and M. Mazanek, “Software tools for efficient generation, modelling and optimisation of fractal radiating structures,” *IET Microw. Antennas Propag.*, vol. 5, no. 8, pp. 1002–1007, 2011.
- [27] M. Capek, P. Hamouz, P. Hazdra, and J. Eichler, “Implementation of the Theory of Characteristic Modes in Matlab,” *IEEE Antennas Propag. Magazine*, vol. 55, no. 2, pp. 176–189, April 2013.
- [28] G. A. E. Vandenbosch, “Reactive energies, impedance, and Q factor of radiating structures,” *IEEE Trans. Antennas Propag.*, vol. 58, no. 4, pp. 1112–1127, Apr. 2010.

- [29] M. Capek, P. Hazdra, and J. Eichler, “A method for the evaluation of radiation Q based on modal approach,” *IEEE Trans. Antennas Propag.*, vol. 60, no. 10, pp. 4556–4567, Oct. 2012.
- [30] W. R. Eisenstadt, B. Stengel, and B. M. Thompson, *Microwave Differential Circuit Design Using Mixed-Mode S-Parameters*. Artech House, 2006.
- [31] S. N. Sinha and N. Jain, “A self-affine fractal multiband antenna,” *IEEE Antennas and Wireless Propag. Letters*, vol. 6, pp. 110–112, 2007.
- [32] J. Eichler, “Multiband antenna with a fractal motif,” Master’s thesis, Czech Technical University in Prague, Prague, Czech Republic, 2010, (in czech).
- [33] J. Eichler, P. Hazdra, M. Capek, T. Korinek, and P. Hamouz, “Design of a dual-band orthogonally polarized l-probe-fed fractal patch antenna using modal methods,” *IEEE Antennas Wireless Propag. Lett.*, vol. 10, pp. 1389–1392, 2011.
- [34] P. Hazdra, M. Mazanek, and J. Cermak, “Wideband rectangular microstrip patch antenna using L-probe feeding system,” *Radioengineering*, vol. 16, no. 3, pp. 37–41, 2007.
- [35] P. Bhartia, I. Bahl, R. Garg, and A. Ittipiboon, *Microstrip Antenna Design Handbook*. Norwood, Mass, USA: Artech House, 2000.
- [36] J. R. James, P. S. Hall, and C. Wood, *Microstrip Antenna Theory and Design*. Peter Peregrinus Ltd., 1981.
- [37] M. Edwards and J. Sinsky, “A new criterion for linear 2-port stability using a single geometrically derived parameter,” *IEEE Trans. on Microw. Theory Tech.*, vol. 40, no. 12, pp. 2303–2311, 1992.
- [38] AWR. [Online]. Available: web.awrcorp.com
- [39] P.-O. Persson and G. Strang, “A simple mesh generator in MATLAB,” *SIAM Review*, vol. 42, pp. 329–345, 2004.
- [40] P. Kravanja, T. Sakurai, H. Sugiura, and M. V. Barel, “A perturbation result for generalized eigenvalue problems and its application to error estimation in a quadrature method for computing zeros of analytic functions,” *Journal of Computational and Applied Mathematics*, vol. 161, pp. 339–347, 2003.
- [41] J. C. Rautio, “An investigation of an error cancellation mechanism with respect to sub-sectional electromagnetic analysis validation,” *International Journal of Microwave and Millimeter-Wave Computer-Aided Engineering*, vol. 6, pp. 430–435, 1996.
- [42] J. Eichler, D. Segovia-Vargas, P. Hazdra, M. Capek, and V. Gonzalez-Posadas, “Active low noise differentially fed dipole antenna,” in *10th International Symposium on Antennas, Propagation & EM Theory (ISAPE - 2012)*, 2012.

- [43] J. Eichler, P. Hazdra, M. Capek, and M. Mazanek, “Modal resonant frequencies and radiation quality factors of microstrip antennas,” *International J. of Antenas and Propag.*, vol. 2012, pp. 1–9, 2012.
- [44] J. Eichler, P. Hazdra, and M. Capek, “Aspects of mesh generation for characteristic mode analysis,” *IEEE Antennas Propag. Magazine*, (in review).

Publikace vztahující se k tématu disertační práce

Procentuální podíl všech spoluautorů u uvedených publikací je rovnoměrný.

Publikace v impaktovaných časopisech

- M. Capek, L. Jelinek, P. Hazdra, and **J. Eichler** (25%), “The Measurable Q Factor and Observable Energies of Radiating Structures,” *IEEE Transactions on Antennas and Propagation*, vol. 62, no. 1, pp. 311-318, Jan. 2014.
- P. Hazdra, M. Capek, and **J. Eichler** (33%), “Comments to “Reactive Energies, Impedance, and Q Factor of Radiating Structures” by G. Vandenbosch, ” *IEEE Transactions on Antennas and Propagation*, vol. 61, no. 12, pp. 6266-6267, Dec. 2013.
- M. Capek, P. Hamouz, P. Hazdra, and **J. Eichler** (25%), “Implementation of the Theory of Characteristic Modes in MATLAB,” *IEEE Antennas and Propagation Magazine*, vol. 55, no. 2, pp. 176-189, April 2013.
- **J. Eichler** (25%), P. Hazdra, M. Capek, and M. Mazanek, “Modal Resonant Frequencies and Radiation Quality Factors of Microstrip Antennas,” *International Journal of Antennas and Propagation*, vol. 2012, pp. 1-9, 2012.

Citováno:

- M. S. Ahmad, C. Y. Kim, and J. G. Park, “Multishorting Pins PIFA Design for Multiband Communications, ” *International Journal of Antennas and Propagation*, Article Number: 403871, 2014.
- M. Capek, P. Hazdra, and **J. Eichler** (33%), “A Method for the Evaluation of Radiation Q Based on Modal Approach,” *IEEE Transactions on Antennas and Propagation*, vol. 60, no. 10, pp. 4556-4567, Oct. 2012.

Citováno:

- M. Shahpari, D. V. Thiel, and A. Lewis, “An Investigation Into the Gustafsson Limit for Small Planar Antennas Using Optimization,” *IEEE Transactions on Antennas and Propagation*, vol. 62, pp. 950-955, Feb. 2014.
- **J. Eichler** (20%), P. Hazdra, M. Capek, T. Korinek, and P. Hamouz, “Design of a Dual-band Orthogonally Polarized L-probe-fed Fractal Patch Antenna Using Modal Methods,” *IEEE Antennas Wireless Propag. Lett.*, vol. 10, pp. 1389-1392, 2011.

Citováno:

- B. K. Lau, M. Martinez-Vazquez, “Guest Editorial: IEEE AWPL Special Cluster on Terminal Antenna Systems for 4G and Beyond,” *IEEE Antennas Wireless Propag. Lett.*, vol. 12, pp. 1669-1673, 2013.
- P. Hazdra, M. Capek, and **J. Eichler** (33%), “Radiation Q -factors of Thin-wire Dipole Arrangements,” *IEEE Antennas Wireless Propag. Lett.*, vol. 10, pp. 556-560, 2011.

Citováno:

- G.A.E Vandenbosch, “Radiators in Time Domain–Part I: Electric, Magnetic, and Radiated Energies,” *IEEE Transactions on Antennas and Propagation*, vol. 61, pp. 3995-4003, Issue: 8, Aug. 2013.
- M. Gustafsson and S. Nordebo, “Optimal Antenna Currents for Q , Superdirectivity, and Radiation Patterns Using Convex Optimization,” *IEEE Transactions on Antennas and Propagation*, vol. 61, pp. 1109-1118, Issue: 3, March 2013.
- B.L.G. Jonsson and M. Gustafsson, “Stored energies for electric and magnetic currents with applications to Q for small antennas,” *Electromagnetic Theory (EMTS), Proceedings of 2013 URSI International Symposium on*, pp. 1050-1053, 20-24 May 2013.
- M. Capek, P. Hazdra, P. Hamouz, and **J. Eichler** (25%), “A Method For Tracking Characteristic Numbers and Vectors,” *Progress In Electromagnetics Research B*, vol. 33, pp. 115-134, 2011.

Publikace v impaktovaných časopisech (probíhá recenze)

- M. Capek, L. Jelinek, P. Hazdra, and **J. Eichler** (25%), “An Analytical Evaluation and The Lower Bounds of The Measurable Quality Factor Q_Z ,” *IEEE Antennas and Propagation Magazine* (in review).
- P. Hazdra, M. Capek, **J. Eichler** (25%), and M. Mazanek, “The Radiation Q -Factor of a $\lambda/2$ Dipole Above Ground Plane,” *IEEE Antennas Wireless Propag. Lett.* (in review).
- **J. Eichler** (33%), P. Hazdra, and M. Capek, “Aspects of Mesh Generation for Characteristic Mode Analysis,” *IEEE Antennas and Propagation Magazine* (in review).
- M. Capek, **J. Eichler** (33%), and P. Hazdra, “Evaluation of Radiation Efficiency from Characteristic Currents,” *IET Microw. Antennas Propag.* (in review).

- P. Hamouz, P. Hazdra, M. Capek, **J. Eichler** (14%), A. Diallo, F. Ferrero, and C. Luxey, “Polarization Diversity in UMTS Mobile Phones analyzed with Characteristic Modes,” *IEEE Antennas Wireless Propag. Lett.* (in review).

Publikace v recenzovaných časopisech

Publikace excerptované WoS

- M. Capek, L. Jelinek, P. Hazdra, and **J. Eichler** (25%), “The Source Definition of The Quality Factor Q_Z ,” *IEEE International Symposium on Antennas and Propagation and USNC-URSI Radio Science Meeting*, 2014, Memphis, USA.
- L. Jelinek, M. Capek, P. Hazdra, **J. Eichler** (25%), “Lower Bounds of the Quality Factor Q_Z ,” *IEEE International Symposium on Antennas and Propagation and USNC-URSI Radio Science Meeting*, 2014, Memphis, USA.
- M. Capek, P. Hazdra, **J. Eichler** (20%), P. Hamouz, and M. Mazanek, “Acceleration Techniques in Matlab for EM Community,” in *Proceedings of the 7th European Conference on Antennas and Propagation (EUCAP)*, Gothenburg, Sweden, April 2013.
- **J. Eichler** (20%), D. Segovia-Vargas, P. Hazdra, M. Capek, and V. Gonzalez-Posadas, “Active Low Noise Differentially Fed Dipole Antenna,” in *10th International Symposium on Antennas, Propagation and EM Theory (ISAPE 2012)*, 2012.
- P. Hazdra, M. Capek, **J. Eichler** (20%), T. Korinek, and M. Mazanek, “On the Modal Resonant Properties of Microstrip Antennas,” in *Proceedings of the 6th European Conference on Antennas and Propagation (EUCAP 2012)*, pp. 1650-1654, 2012.
- M. Capek, P. Hazdra, **J. Eichler** (20%), P. Hamouz, M. Mazanek, and V. Sobotikova, “The Evaluation of Total Radiation Q Based on Modal Approach,” in *Proceedings of the 6th European Conference on Antennas and Propagation (EUCAP)*, Prague, Czech Republic, April 2012.
- P. Hazdra, M. Capek, **J. Eichler** (20%), P. Hamouz, and M. Mazanek, “Radiation Q of Dipole Modal Currents,” in *Proceedings of the 5th European Conference on Antennas and Propagation (EUCAP)*, Rome, Italy, pp. 1578-1581, April 2011.
- P. Hazdra, **J. Eichler** (20%), M. Capek, P. Hamouz, and T. Korinek, “Small Dual-band Fractal Antenna with Orthogonal Polarizations,” in *Proceedings of the 5th European Conference on Antennas and Propagation (EUCAP)*, 2011.

Ostatní publikace

(žádné)

Summary

This thesis deals with the theory that when uniquely defined by the scattering surface, characteristic modes for conducting bodies define a complete set of basis functions orthogonal with respect to radiated power. The key property is that only a small number of modes for electrically small and intermediate bodies usually suffices to characterize the radiated or scattered fields with sufficient accuracy. These modes have already been used for various antenna designs, such as multiple-input multiple-output, ultra-wideband, and electrically small amongst others.

A complete work-flow from antenna specifications to the final manufactured and measured dual-band antenna using modal information is presented in this thesis. The characteristic modes are used to interpret the effect of current distribution and height over an infinite conducting plane on a modal resonant frequency and radiation quality factor. A prototype of a low-noise active differential antenna, including differential S-parameters measurements, is described. The strengths, weaknesses and possible usage of characteristic modes are discussed with respect to active differentially fed antenna application.

To enable the efficient analysis of various antenna geometries, a tool for surface mesh generation was developed to be used in conjunction with an in-house modal analyzer. The tool was shown to be versatile and suitable for implementing new research approaches related to the numerical aspects of computation of characteristic modes. The effect of quadrature errors on the numerical computation of characteristic modes by the method of moments is described. The derivations have been verified by the numerical convergence of modal resonant frequency, radiation quality factor and maximal directivity with increased mesh density. Recommendations for mesh refinement strategy, based on the error analysis, have been successfully applied to the in-house tool, as well as to a commercial FEKO package.

A method of computing modal excitation coefficients for capacitively coupled conducting bodies has been derived and good agreement between the proposed and direct electric field integral equation solution was observed.

Resumé

Tato práce se zabývá teorií charakteristických modů, která definuje množinu funkcí, ortogonálních vzhledem k vyzářenému výkonu, která je jednoznačně definovaná geometrií vyzářující struktury. Klíčovou vlastností je, že pro dostatečně přesný popis vyzářeného pole elektricky malé a středně velké struktury, obvykle postačuje pouze několik modů. Charakteristické mody již byly použity pro návrh různých typů antén, mimo jiné MIMO, širokopásmových, nebo elektricky malých antén.

V této disertační práci je popsán kompletní návrh, začínající specifikací anténních parametrů až po vyrobený a změřený prototyp dvoupásmové planární antény pomocí teorie charakteristických modů. Závislost modální rezonanční frekvence a vyzářovacího činitele jakosti na rozložení proudové hustoty a výšce nad nekonečnou elektricky vodivou rovinou je vysvětlena na základě informace poskytnuté modální analýzou. Dále je prezentován prototyp aktivní, diferenčně napájené antény, včetně měření diferenčních rozptylových parametrů. Přednosti, omezení a možnosti použití charakteristických modů jsou diskutovány s ohledem na návrh aktivních diferenčně napájených antén.

V rámci disertace byl vyvinut nástroj pro tvorbu povrchové mříže, který spolupracuje s modálním řešičem vyvíjeným na Katedře elektromagnetického pole FEL ČVUT a umožňuje efektivní analýzu parametrizovaných antén. Bylo ukázáno, že nástroj je flexibilní a vhodný pro implementaci nových výzkumných přístupů souvisejících s numerickým výpočtem charakteristických modů. Práce popisuje vliv chyby numerické integrace a aproximační chyby na numerický výpočet charakteristických modů pomocí metody momentů. Provedená odvození byla verifikována numerickou konvergencí rezonanční frekvence, činitele jakosti a maximální směrovosti s rostoucí hustotou mříže. Na základě analýzy chyb byla formulována doporučení pro postup zahuštění mříže, která byla aplikována na modální řešič a také na komerční implementaci v programu FEKO.

Byla odvozena metoda výpočtu vazebních a budících modálních koeficientů pro elektricky vázané struktury. Metoda vykazuje velmi dobrou shodu s přímým řešením integrální rovnice pro elektrické pole.