

Bachelor's Thesis



**Czech
Technical
University
in Prague**

F3

**Faculty of Electrical Engineering
Department of Cybernetics**

Design of a tiltable sidelight for an Unmanned Aerial Vehicle

Jiří Budil

**Supervisor: Ing. David Žaitlík
Field of study: Cybernetics and Robotics
December 2020**

I. Personal and study details

Student's name: **Budil Jiří**

Personal ID number: **474554**

Faculty / Institute: **Faculty of Electrical Engineering**

Department / Institute: **Department of Cybernetics**

Study program: **Cybernetics and Robotics**

II. Bachelor's thesis details

Bachelor's thesis title in English:

Design of a Tilttable Sidelight for an Unmanned Aerial Vehicle

Bachelor's thesis title in Czech:

Návrh bočního osvětlení pro autonomní multirotorovou helikoptéru

Guidelines:

This thesis aims to design a tilttable sidelight to be carried by an Unmanned Aerial Vehicle (UAV) for indoor photography of historical buildings.

The UAV will be equipped with sensors required for autonomous flight and an anchoring device for safe contact with a wall.

It must be possible to change the temperature and tilt of the light during the flight.

- 1) Design the mechanical solution.
- 2) Design the electronic control unit of the light.
 - a) Select an appropriate motor for tilting the light.
 - b) Design a suitable electrical circuitry for control of the light temperature.
 - c) Use an STM32 family microcontroller to control the light and communicate with the onboard computer.
- 3) Implement a program for the onboard computer of the UAV to control the microcontroller via USB. This program must be implemented using ROS for use with the MRS Group system.
- 4) Test the functionality of the device.

Bibliography / sources:

- [1] M. Saska, V. Krátký, V. Spurný and T. Báča, 'Documentation of dark areas of large historical buildings by a formation of unmanned aerial vehicles using model predictive control,' 2017 22nd IEEE International Conference on Emerging Technologies and Factory Automation (ETFA), Limassol, 2017
- [2] Carmine Noviello, Mastering STM32, 2018
- [3] Anis Koubaa, Robot Operating System (ROS), The Complete Reference (Volume 3), 2018

Name and workplace of bachelor's thesis supervisor:

Ing. David Žaitlík, Multi-robot Systems, FEE

Name and workplace of second bachelor's thesis supervisor or consultant:

Date of bachelor's thesis assignment: **16.09.2020** Deadline for bachelor thesis submission: **05.01.2021**

Assignment valid until: **19.02.2022**

Ing. David Žaitlík
Supervisor's signature

doc. Ing. Tomáš Svoboda, Ph.D.
Head of department's signature

prof. Mgr. Petr Páta, Ph.D.
Dean's signature

III. Assignment receipt

The student acknowledges that the bachelor's thesis is an individual work. The student must produce his thesis without the assistance of others, with the exception of provided consultations. Within the bachelor's thesis, the author must state the names of consultants and include a list of references.

Date of assignment receipt

Student's signature

Acknowledgements

Firstly, I would like to thank my supervisor Ing. David Žaitlik, whose expertise was very valuable in formulating comments and advice, also for his guidance and goodwill.

I would also like to thank Ing. Vít Krátký and Ing. Pavel Petráček for their help and useful advice at the beginning of this project. Next, thanks belong to all MRS Group for their assistance in the lab and also for the opportunity to do a project. In addition, I would like to thank my parents for their support.

Sincerely, thank you.

Declaration

I declare that the presented work was developed independently and that I have listed all sources of information used within it in accordance with the methodical instructions for observing the ethical principles in the preparation of university theses.

In Prague, 21. December 2020

Abstract

The thesis deals with the description of the design of sidelight for an autonomous multi-rotor helicopter. The light source sticks out away from the drone body and thus allows the helicopter to illuminate the scene laterally, without the risk of a possible collision of the propeller with surrounding objects.

The system also implements a mechanism for stabilizing the drone on the wall or other vertical obstacles. The light source can be tilted, changing intensity and colors. A PCB was designed for control, with a built-in STM32 microcontroller. The thesis contains a more detailed description of the PCB design, including an explanation of the relevant peripherals and a description of drone communication.

The performed experiments verify the functionality of the designed device.

Keywords: UAV, dron, sidelight, wall-retaining mechanism, contact with obstacle, sticking to the wall, DPS

Supervisor: Ing. David Žaitlík

Abstrakt

Práce se zabývá popisem návrhu bočního osvětlení pro autonomní multirotorovou helikoptéru. Navržený systém předsazuje světelný zdroj mimo dronu a tím umožňuje helikoptéře nasvítit scénu bočně, bez rizika možné kolize vrtulí s okolními předměty.

Systém zároveň implementuje mechanismus pro stabilizaci dronu na zdi, nebo jiné kolmé překážky. Světelný zdroj je možné polohovat, ovlivňovat intenzitu a barvy. Pro řízení byla navržena DPS, se zabudovaným mikrokontrolérem z rodiny STM32. Součástí práce je podrobnější popis návrhu DPS, včetně vysvětlení příslušných periférií a zajištění komunikace s dronem. Provedené experimenty ověřují funkčnost navrženého zařízení.

Klíčová slova: UAV, bezpilotní helikoptéra, boční svícení, přichytný mechanismus, kontakt s překážkou, DPS

Překlad názvu: Návrh bočního osvětlení pro autonomní multirotorovou helikoptéru

Contents

1 Introduction	1	3.1.1 Weight of the Enclosures and Electronics	14
1.0.1 Possible solutions	1	3.1.2 Light placement	14
1.0.2 Lighting techniques	2	3.1.3 Servomotor	15
1.1 Tarot T650 Sport drone	2	3.1.4 Attachment to the Drone	16
1.2 Aputure Amaran HR672W/S/C Light	3	3.1.5 CIWW Attachment	16
1.2.1 Design principle	4	3.1.6 Battery holder	18
2 First Prototype	5	3.2 Conclusion	19
2.1 Construction	6	4 Control Unit Design	21
2.2 Ensuring the balance of the system	7	4.1 Introduction	21
2.3 System attachment	8	4.2 Light source description	21
2.4 Overall design / dimensions	8	4.3 Intensity control	23
2.5 Control	8	4.4 Color control	23
2.6 Experiments	9	4.5 MCU	25
2.7 Conclusion	11	4.5.1 Wiring diagram	26
3 Second Prototype	13	4.5.2 Kicad Diagram	26
3.1 Improvements	13	4.5.3 Programming connector	27
		4.6 Power sources	28

4.6.1 MCU power source	29
4.6.2 AX12A power source	29
4.7 Protections	31
4.8 PCB layout	32
5 Software and Firmware Implementation	35
5.1 Introduction	35
5.2 On-Board Computer Software Implementation	36
5.3 Microcontroller Firmware Implementation	38
6 Experiments	41
7 Conclusions	45
A Bibliography	47
B List of Abbreviation	51
C CD Content	53



Chapter 1

Introduction

Historians need to determine the state of a given historical object. They need to find out if there are no cracks, mold, or various defects. It is, therefore, necessary to map many reliefs, walls, sculptures, and others. Some places can be reached from the ground, but for more, we usually need: ladder, platform, the construction of scaffolding, or the help of heavier equipment, such as a crane. Furthermore, there are many other associated complications. When handling larger machines, the probability of accidental destruction of some part of the historic building increases. The price is also increasing. Therefore, it is complicated to map some places; also, these places are usually poorly lit.

1.0.1 Possible solutions

The solution could be a UAV-Unmanned aerial vehicle carrying a camera that will map the object. The research [16] deals with this, and this work is based on its findings. The question here might be why the drone carrying the camera could not be a lighting drone simultaneously. However, this solution is not suitable because there are specific requirements for lighting techniques.

1.0.2 Lighting techniques

In the case of illuminating a specific relief with direct vertical light, the object's structure is optically suppressed according to [5], and it is not easy to recognize the edges in the camera recording. However, if we illuminate the scene with sidelight as shown in figure 1.1, the relief will reveal its structure [5], and it will be much easier to detect various defects. A solution to such a problem could be a system operating with two drones—one drone carrying the camera while the other drone illuminates the scene sideways.

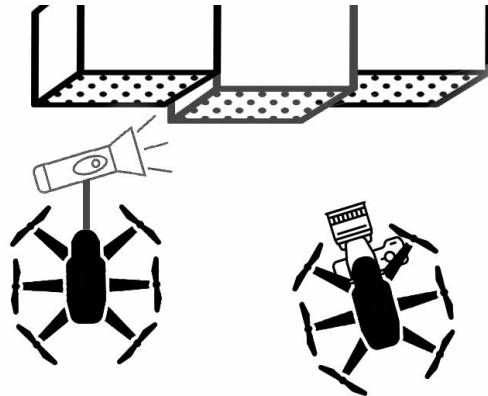

Figure 1.1: Schematic

Therefore, it is necessary to create a lighting technician drone, or we can call it UAV illuminator.

1.1 Tarot T650 Sport drone

The Tarot T650 Sport drone shown in figure 1.2 was given for this application as part of the assignment.

The Tarot T650 Sport platform is a quadcopter often used in the MRS laboratory. It is a large general-purpose platform with high lifting capability. It is ideal for larger payloads and sensors, and longer flights. It was selected because it can be easily modified and customized. The drone is controlled by a NUC8i7BEH and Pixhawk. It has 15 inch carbon fiber propellers. Lifting power is provided by 4x 4114 320kV motors, which are powered by 6S 8000 mAh LiPo battery.

Thanks to this, it is capable of carrying approx 3.5 kg extra weight.



Figure 1.2: Tarot T650 from MRS lab[2]

1.2 Aputure Amaran HR672W/S/C Light

The LED panel from Aputure Amaran HR672W/S/C light was given for this application as part of the assignment. The Aputure Amaran light is a professional cameraman's light used for filming(see figure 1.3). The Aputure Amaran HR672W / S / C light has a luminous flux value of 4636.8 lumens with a temperature of 5500 ° K. It excels with a good CRI 95+ value. It has a maximum power consumption of 45W. The manufacturer states that the light should not become significantly hot during lighting.



Figure 1.3: Aputure Amaran HR672W/S/C

■ 1.2.1 Design principle

Here is the question of where to place the light. With its propellers, UAV is large, and there is an effort to implement the lighting as much as possible from the side. So it is clear that placing light below/above the drone base is not an ideal solution, although it is the simplest solution.

Therefore, the idea arose to off-center the light and put it to the drone's edge. However, from previous experiments, it was known that light could not be placed under the propellers because it would affect the airflow. So, it would act as a wing, and that is unacceptable. It would cause drone mismanagement.

It was, therefore, necessary to place the light out of reach of the propellers. An idea arose with this proposal. It would be best to combine the solution with a system for keeping drones on the wall, which was developed in recent years as part of a bachelor's thesis by Dan Smrcka[3]. This system will be referred to as the abbreviation CIWW as Controlled Interaction with the Wall for better clarity.

Thanks to this design, it would be possible to get the light of the drone as close to the wall as possible, and at the same time, there is no need to worry about the propellers colliding with the wall. However, the original system was dimensioned for a another drone, and there was no need to place a light source or anything else between wall and UAV body. So the previous system did not have to be balanced. In our case, the one-sided load is not negligible, so it is necessary to consider the balance.

Chapter 2

First Prototype

We were also given requirements to control the light. It should be possible to control the color temperature and intensities of light. At the same time, rotate the LED panel in an axis parallel to the drone base.

The ideal solution is such that it enable to rotate the LED panel in its entire range and simultaneously ensures that the scene will not be shaded by any other part of or system.

However, it is necessary that the construction is strong and rigid enough to support the light, the CIWW 2.1a and the balancing load. At the same time, it should be as light as possible. Here the idea was implemented to keep the structure as narrow as possible and rotate the light around this whole structure (see figure 2.1b).

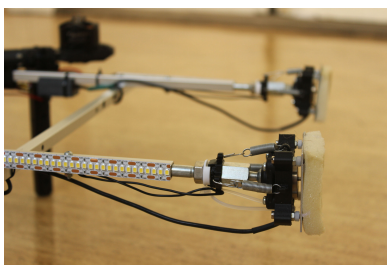

(a) : CIWW



(b) : 3D printed bearings

Figure 2.1: Mechanical parts

To rotate the light, it is not possible to attach the rotor of the servomotor directly to it, but some suitable mechanism is needed. So two gears that were printed on a 3D printer were chosen as a suitable solution.

The larger wheel has a pitch diameter of 36 mm. The module is 1.2 and has

ten teeth. The smaller wheel has a pitch diameter of 12 mm. The module is 1.2 and 30 teeth. The backlash was set to 0.15 mm. Thus, the gear ratio between the gears is exactly 3:1.

The size of the individual wheels is given by the formula $d_r = m * z$ where d_r is the reference diameter $d_a = m * (z + 2)$. The pressure angle between the wheels is 20 degrees. The module and the number of teeth were chosen, so the resulting wheel parameters correspond to the proposed design. The larger gear should be mounted on the structure and the smaller gear will be attached to the servomotor rotor shown in figure 2.2. It is necessary that the larger wheel has a holder that allows to hold the LED panel.

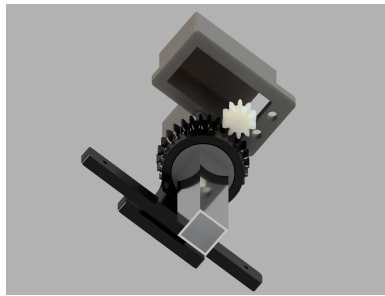

(a) : 3D model

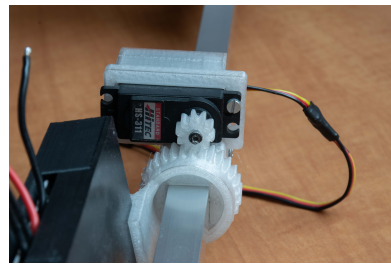

(b) : Real implementation

Figure 2.2: Gear mechanism

2.1 Construction

Construction materials were selected from commonly available sources. Due to the smallest possible weight, aluminum proved to be a suitable material. The best construction material was an aluminum profile 15x15mm, 1mm thick anodized, which met the rigidity requirements and was light enough. Profile weighs 212g in length 139,5cm (152g / meter). The supplied LED panel was carrying a case with electronics. The larger gear was attached to the case with electronics and also secured with a screw (see figure 2.3a).

The HS-311 shown in figure 2.4 was chosen as a suitable servomotor. A case was then printed for him on a 3D printer, which could be slid onto an aluminum profile. During the development of this version, the tilting resistance was not known. So it was not clear if one servomotor would be enough.

For this reason, the case with the servomotor was designed on both sides.

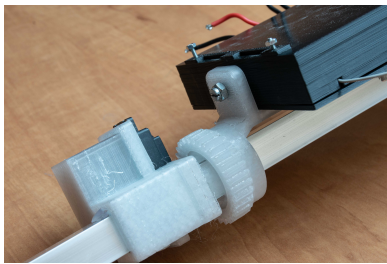

(a) : Detail

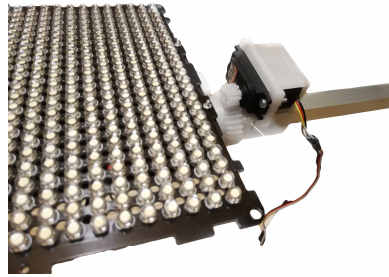

(b) : HS-311 attachment

Figure 2.3: LED panel attachment

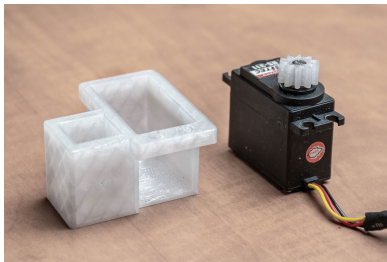

(a) : Disassembled servomotor

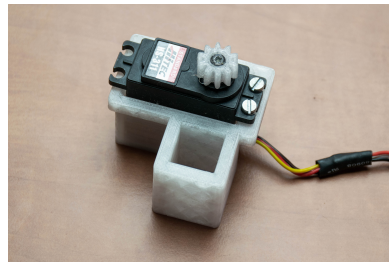

(b) : HS-311 assembled in holder

Figure 2.4: HS-311 and its holder

2.2 Ensuring the balance of the system

Balancing one-sided weight was realized by a battery with a battery holder on the other side of the profile (see figure 2.5). The battery holder, widely used in the MRS laboratory, was used. Two small aluminum sheets were screwed to the profile so that the case could be assigned. Detail is shown in figure 2.5a. The center of the battery holder is located 49 cm from the center of the drone.

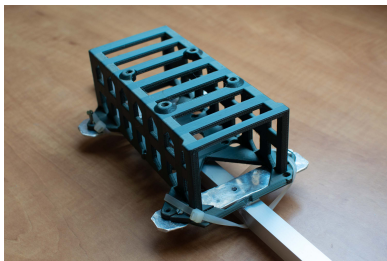

(a) : Detail

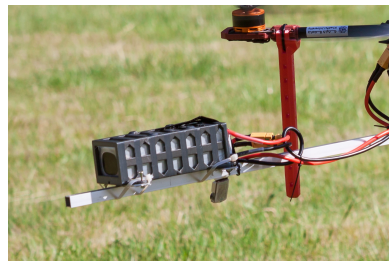

(b) : Holder with battery

Figure 2.5: Battery holder

2.3 System attachment

The lower carbon profile of the drone has several holes in it. There are screws in them that hold the drone together. A battery holder is also commonly attached under these screws. However, the battery holder is located on our construction, and these screws can be used to attach the entire construction. The aluminum profile was placed further under the drone so that the LED panel can not collide with the propeller. The connecting parts were made of aluminum sheets (see figure 2.6).



(a) : bended aluminium sheets

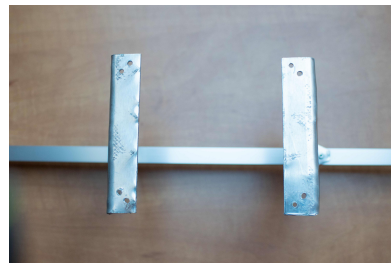

(b) : Top view

Figure 2.6: System attachment

2.4 Overall design / dimensions

The parts: cases from the servomotors, the mechanism, and the LED panel has a length of 33,5 cm. The edge of the servo holder is placed 26 cm from the center of the drone. During the production of this version, the CIWW system was not available because it was being improved. Instead, it was replaced by weight with a corresponding value. The center of the battery holder was placed 49 cm from the center of the drone.

2.5 Control

Case with electronics had two connectors. The XT60 connector was designed for power supply. The XT30 connector was connected to the Arduino. Connectors can be seen in figure 2.7b. The Arduino was used here as a switch and sent 5V or 0V to the light. At 5V, the LED panel was on. At 0V, the LED panel was off. In this version, the intensity control was equipped with a

trimmer located in a case with electronics (see figure 2.7a). Due to the the work of the previous assignee the color control was inoperable. However, for the purposes of the first tests, this was sufficient.

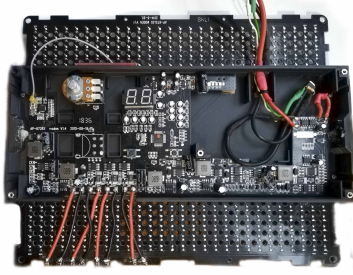

(a) : Electronics of LED panel

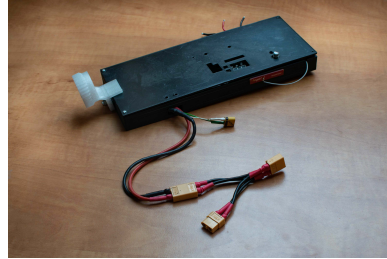

(b) : Connectors

Figure 2.7: Electronics

2.6 Experiments

This first prototype was tested during the June MRS camp. The main purpose was to verify whether this design is usable. If it has sufficient load capacity not only for take off from the ground, but also sufficient reserves for reliable and full control. It was also necessary to find out whether one servomotor will be enough to control the LED panel.

Before the first flight, the drone was, for sure, lightened. Before take-off, it was tested if only one servomotor is needed to rotate the LED panel. The second servomotor was, therefore, removed. Contrary to some expectations, it has been verified that the drone is not only able to take off with this load but also that only 60% of the power is used during hovering. Figure 2.8b shows a drone in flight. This concept is light enough, even with a considerable margin.



(a) : Preparations



(b) : First flight

During operation, however, it was known that the drone has a mass distributed farther from its center and has a greater moment of inertia. As a result, it swayed during the flight, and the flight was not smooth.

On the second flight, it was necessary to test the panel itself. At the same time, we wanted to verify whether a controlled CIWW system is really necessary for this application. Before take-off, several adjustments were made, including some already mentioned in the previous points. The drone had the necessary cabling to control the light at this moment. However, a uniform battery power supply has not yet been prepared. So a second smaller battery was added. It was attached under the drone.



(a) : Hovering



(b) : attempt to attachment



(a) : attempt to attachment

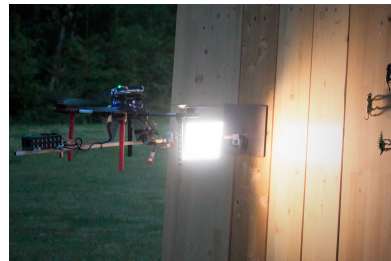

(b) : night flight

Figure 2.10: Experiments

The take-off took place for the second time without any problems. The drone had no problems with the added load (see figure 2.9a). Pilot Pavel Petráček tried to keep the drone on the wall, as shown in the figure 2.10a. However, there was a problem with the swaying of the drone. The drone moved away from the wall several times during the attempt and crashed into it again. From several attempts, it was clear that a man cannot keep the drone stable on the wall. Therefore, the assumption that it is essential to use the CIWW system for this task was confirmed. The last figure 2.10 shows the third night flight, when the wall is sideways lit.

■ 2.7 Conclusion

The first functional prototype of the system was designed. It was possible to rotate the light around the aluminum profile without shading anything. Experiments have verified that it is necessary to implement a CIWW system. The aluminum profile has been verified as a suitable main structural element, and we know that it will be probably used in the second prototype. However, we also found many shortcomings and received suggestions for improvement. Especially for changing the power electronics and mounting the LED panel.

Chapter 3

Second Prototype

3.1 Improvements

Thanks to the knowledge gained from the first prototype, several ideas emerged on how to improve the system and began to create a second prototype. It was clear that it was appropriate to lighten and reduce the system as much as possible. So the light was rotated 90 degrees (see figure 3.1). The adjustment enabled the rod to be shorter.



(a) : Top side



(b) : bottom side

Figure 3.1: LED panel attachment

3.1.1 Weight of the Enclosures and Electronics

So far, the electronics have been placed directly on the light. Of course, it must be protected by its case. The LED panel itself weighs 250 g, the main part of the printed case weighs 220 g, and the cover part weighs 41 g. This means that the LED panel with accessories weighs a total of 511 g. For the system, this means the weight must be balanced on the other side. This is unnecessary because the weight 261 g of electronics does not have to be placed directly on the light and could be part of the drone's body. Therefore, only the power cables are brought to the LED panel. The design and more detailed description of the custom PCB is described in the next chapter.

3.1.2 Light placement

The nearest possible position of the LED panel to the drone was recalculated. It is needed to respect that the propellers' top projection will not interfere with the LED panel's top projection. LED panel is 23.4 cm long by 18.5 cm wide. The radius of the propellers is 20 cm, and the relative position of components was known.

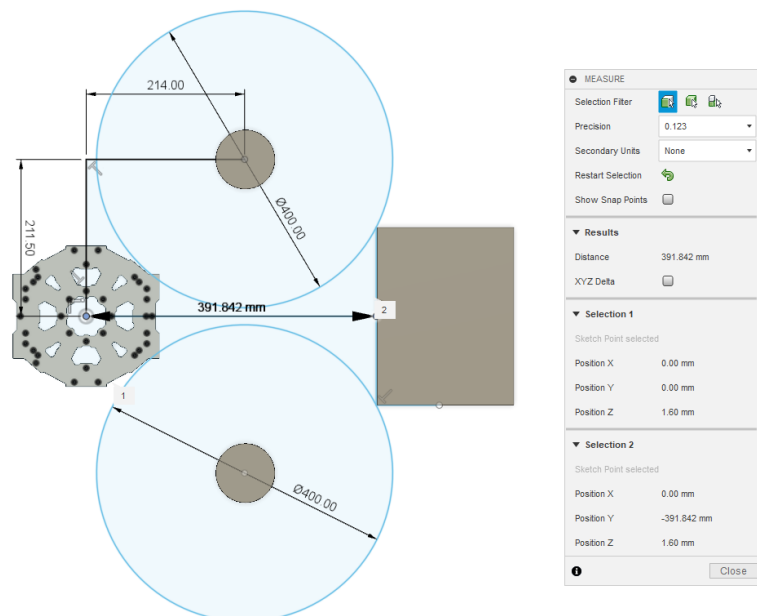

Figure 3.2: top projection drawing

The closer edge of the light can be placed closest to 392mm. This can also

be clearly seen in figure 3.2. However, these are real tools and objects, so an extra margin was count, and the edge of the light is currently 40.5 cm from the center of the drone.

■ 3.1.3 Servomotor

In the previous prototype, the HS-311 servo motor was used. Unfortunately, the range is limited to 202 degrees. The transmission between the gears is 3:1, so it was possible to rotate the LED panel only 67.3 degrees. However, it would be better to rotate the LED panel at least 90 degrees.

So the ideal idea would be to use a servo motor with such a larger range. Here, however, ideal ideas encounter reality. Servomotors with an extended range usually exist up to 270 degrees. Servomotors marked as 360 degrees can be found, but with the note "continuous". This means that the feedback is removed from the servo. Thus, the servomotor can be turned at any angle, but unfortunately, the value of the absolute position is no longer known.

Problem was solved by selecting the "Ax12A servo" shown in figure 3.3a from Robotis [15]. The classic servomotor usually has a encoder which is directly connected to the axis of rotation and is used as feedback. This encoder usually works in a certain range, therefore the range of rotation is also limited.

This AX12A is a digital device that has feedback provided by an encoder but has no stop. This servomotor is small, light and corresponds to the usual servo's behavior.

This makes it ideal for the application, rotation of the LED panel can be ensured in the entire range. Compared to the previous HS-311 servo, there is a different communication. The HS-311 [6] was controlled by PWM, but communication with the AX12A servomotor is provided via Half-duplex UART[15].

A holder 3.3b was subsequently made for the AX12-A. A cover was made for



(a) : AX12A

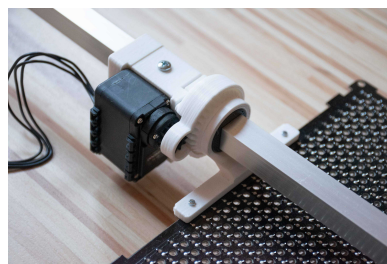

(b) : AX12A in holder

Figure 3.3: Servomotor

the gears. It prevents cables or other components from becoming entangled.

3.1.4 Attachment to the Drone

The original curved aluminum sheets held the system below the drone. However, experiments in Rumburk showed that the drone swayed when the direction of movement changed. It was shown that the dynamics were not ideal. It would therefore be better if the system were attached just below the drone without indentation. Thanks to this, the drone's center of gravity will be closer to its natural place, where it is located even without added equipment. Aluminum sheets shown in figure 3.4 were made.



Figure 3.4: System holder

3.1.5 CIWW Attachment

Base system needed to be connected to the CIWW system [3] by Dan Smrčka. The original CIWW system was designed for the tarot T650 platform and its captured in figure3.5.

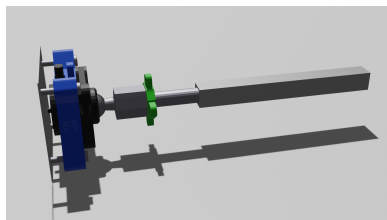

(a) : model of SWGS: strain gauge with a contact surface

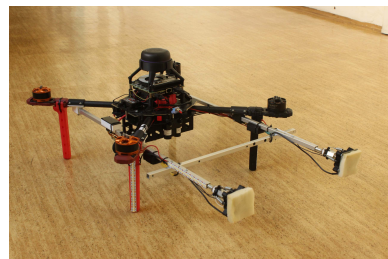

(b) : CIWW attached to Tarot T650

Figure 3.5: CIWW

Figures 3 and 4 show the sensing part. The contact surface is made of aluminum. When in contact, it fits and presses on the strain gauge, which is located in the printed black part. A joint with springs is attached to it, which allows tilting the sensing surface in case of uneven terrain. This part of CIWW is basically a strain gauge with a contact surface shown in figure 3.5a. It will be marked as SGWCS(strain gauge with contact surface) for clarity.

The mechanical parts of the SGWCS system are essential parts. However, the construction that carries the SGWCS cannot be used in current application. Potential possibilities of how to attach the holder was evaluated. There is a necessity that the whole system was as short as possible, and the holder did not collide with the led panel. SGWCS was screwed to a square aluminum 10mm profile using an M8 screw. To better secure and lock the SGWGS in the correct position, The spring holder was modified. Protrusions were added to it that keeps the SGWGS from rotating. Next, it is needed to



(a) : Original attachment

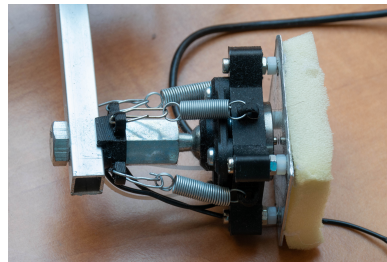

(b) : real holder

Figure 3.6: Edited spring holder

attach this part to base system. In the original system, the suspension was implemented. It would be good to keep them here as well. At the same time, it was known that it would be very impractical to run SGWCS cables along with the LED panel, as various problems could occur. The cables could get caught directly in the gears, or they could get in the way of the light during rotation. Therefore, there was an idea to run the cables through the aluminum profile.

These conditions were taken into account, and a suitable solution was found (see figure 3.8). The 10mm aluminum profile has been bolted perpendicularly to the 25mm square aluminum profile with two screws. The more extensive profile is 35mm long and contains a printed pad inside. Figure 3.7b shows black printed pad inside. It can slide freely on the main aluminum profile. The spring was attached to the profile between the pad and the gear. Design is also very robust, and there is no risk of damage in the event of a harder impact with the wall. Thanks to the chosen solution, it is possible to pass the cables through the aluminum profile. The CIWW is spring-loaded (see figure 3.8b), and the gap between the wall and the LED panel is minimal.

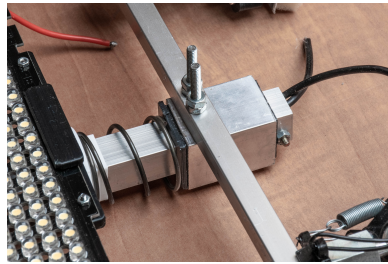

(a) : CIWW implemented

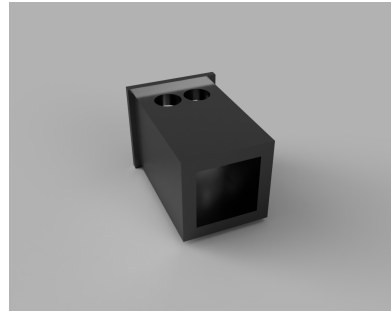

(b) : pad

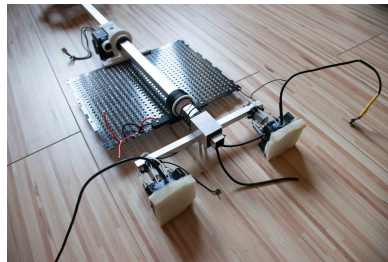

(a) : The entire attachment



(b) : Spring implementation

Figure 3.8: CIWW attachment

3.1.6 Battery holder

The original battery holder has been replaced by a holder that is made-to-measure. The new one encircles the rod (shown in figure 3.9) and is secured with a screw. Therefore, it is easy to remove or move the holder if there is any change in the weight distribution. The holder partially extends into space under the propellers. For this reason, it is turned to the ground to be further away from the propellers. This adjustment affects the airflow less.

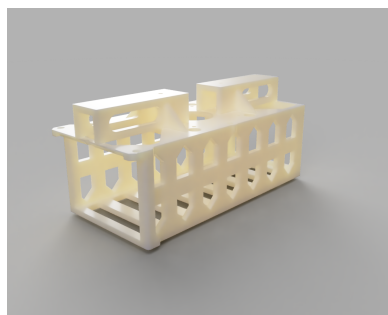

(a) : model

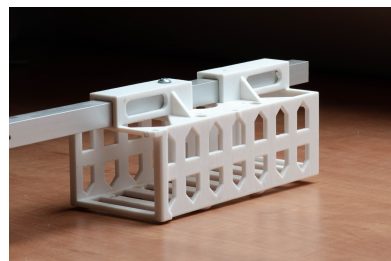

(b) : Real battery holder

Figure 3.9: Battery holder

3.2 Conclusion

A completely new system was made (see figure 3.11). The system is 114 cm long, the aluminum profile is 111cm long, and from the center to the edge of the CIWW, it is only 68 cm. The aluminum profile is 28,5cm shorter compared to first prototype and battery is placed 19,5 cm closer to drone. Figure 3.12 shows 3D model of the system. Additional dimensions can be found in the 3D model file that is attached to the thesis.

Its weight, including electronics except battery, is 1185 g, 543 g better than the previous model. Thanks to the replacement of the servomotor, users have the opportunity to rotate the light arbitrarily. CIWW was implemented, including a spring. The LED panel was rotated 90 degrees, which help reduce the entire system. A new battery holder has been printed as shown in the figure 3.10a. The electronics were transferred to the body of the drone.

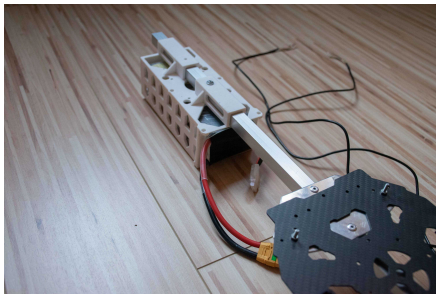

(a) : The system is balanced by battery

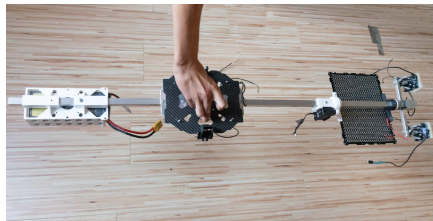

(b) : checking balance

Figure 3.10: Final assembly

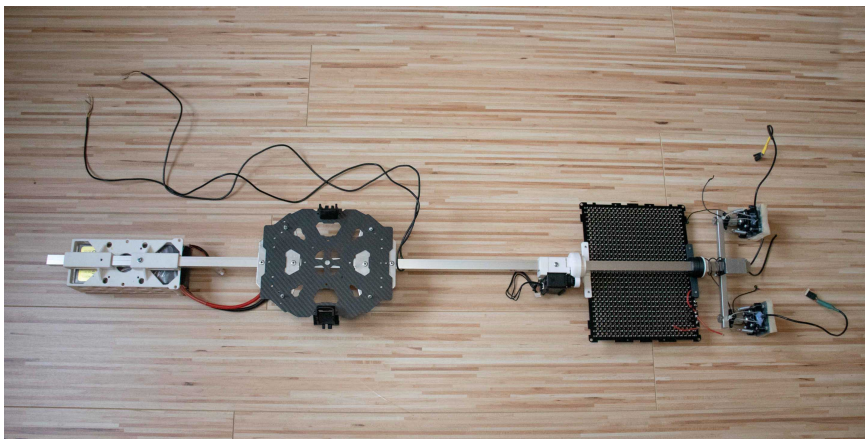

Figure 3.11: The whole system

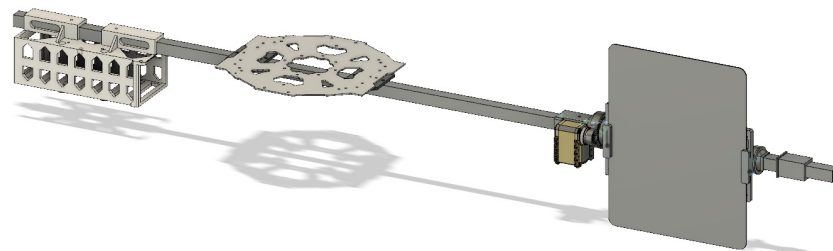

Figure 3.12: 3D model

Chapter 4

Control Unit Design

4.1 Introduction

Designing new electronics for the drone base helped us save weight due to placement. At the same time, it brings the opportunity to solve electronics much more elegantly and compactly, because it is now tailor-made.

The new electronics should manage the following: power supply, intensity and color control of LED panel, servo motor control and communication with the drone.

4.2 Light source description

To properly design electronics, it is first important to understand how it works, how it is arranged, and how it is appropriate to power it.

LED panel is a board where $28 \cdot 24 = 672$ LEDs are soldered. Half of the diodes are warm and half are cold. LEDs of one color are always adjacent in both axes to LEDs of opposite colors. In other words the LEDs are organized like a chessboard as shows figure 4.1.

At the same time, the board consists of two independent parts. This means that 4 pairs of pins are led out of the board. There is one pair which belongs to cold LEDs and one pair which belongs to warm LEDs on each side of the board. One pair supplies 168 LEDs.

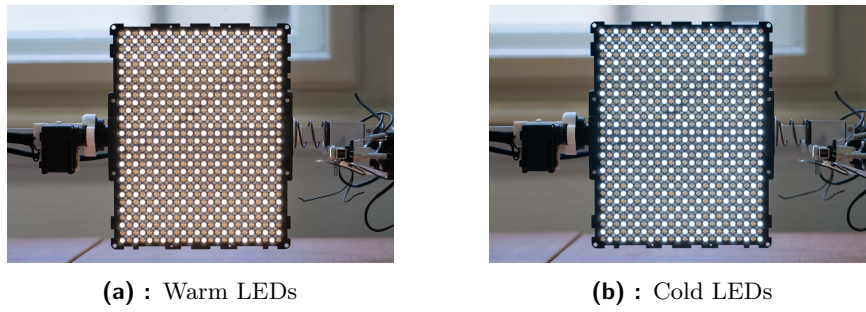

Figure 4.1: LED panel arrangement

Thanks to the fact that the LED panel was already powered by given electronics, we were able to find out how it was done. It is especially important to know what is the maximum supply voltage. If this voltage is exceeded, it could irreversibly destroy the panel.

We know that the panel was powered by 12V. We will therefore count on this information for next design as well. LEDs of this type could have a recommended operating voltage of around 2V. We can assume that the LEDs are probably connected in 28 parallel branches. Six LEDs could be connected to each of these branches. This is illustrated in figure 4.2.

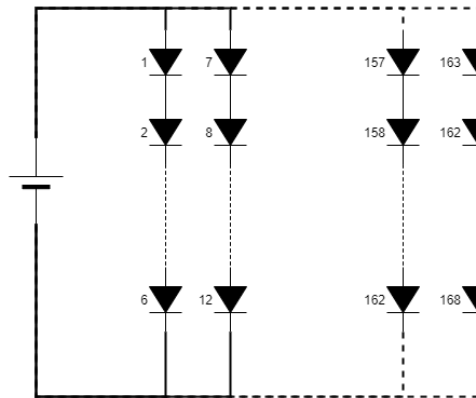

Figure 4.2: Internal wiring

It is also necessary to find out what is the maximum current consumption. In this case, the best way is to verify consumption experimentally. A fixed 12V source was connected to one branch, and a passing current was measured.

A current of 1800 mA was measured at the "warm" branch, and 1720 mA was measured at the "cold" branch. Colder LEDs generally have their characteristics shifted further to the right, so this measurement corresponds to this. The whole LED panel should have a maximum consumption of 3520 mA, and 1800 mA should pass in one supply cable from one color.

4.3 Intensity control

Each diode has its voltage threshold at which it becomes more conductive. It also has some voltage range where it should be used. Therefore, it is not possible to control the intensity of lighting by gradually changing the magnitude of the voltage. Only a voltage stated in the datasheet (around 2V) must be applied to the LED at "on" state, or 0V at "off" state. It is suitable to use PWM: Pulse Width Modulation.

4.4 Color control

A possible solution could be to control separately intensity in each branch and thus change the color (but also influence intensity). And scale both PWMs with the same coefficient and thus correct/control the light intensity. However, there is another solution that we evaluated as more elegant.

It is possible to apply another PWM to the signal once again. But this PWM should have an order of magnitude lower frequency. This PWM forms the "envelope" of faster PWM. The faster PWM (intensity control) should be common to both branches, while the slower PWM (color control) have to be separate for each color. By changing the slower PWMs, it is possible to control the intensity of each color, while changing the PWM with a higher frequency will affect the intensity on both branches. So it will affect the overall intensity.

To implement this type of control, it was necessary to create a schematic, select suitable components, and perform simulations (see figure 4.3).

It is worth emphasizing that these two PWMs are switching 25V power supply directly from the battery. PWM generation can be realized using power MOSFETs which will be controlled by an STM microcontroller. So there is a requirement to be able to control the circuit with TTL logic. It means range 0-3.3V. For the PWM control color, a non-TTL P-MOSFET NTD2955T4G [14] was used. Therefore, the N-MOSFET BSS138 [11] is associated with it as its driver. To control the intensity, the N-MOSFET NTD3055L104T4G [13] was used, which is TTL. Both MOSFETs were selected concerning the current flowing, so they are in the DPAK case. DPAK housing is a large housing for power components. Therefore, heat losses during switching will be minimal. Another advantage of the selected components is that their model exists in the multisim program.

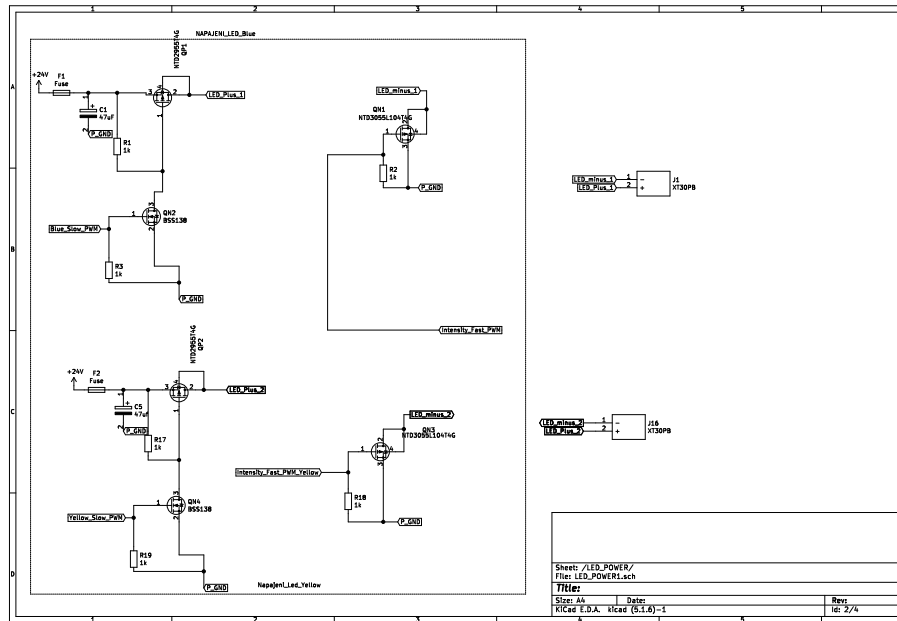

Figure 4.3: Diagram

Simulations to test the functionality of the proposed solution were performed. There is an assumption that the camera will probably record at a maximum frequency of 50 fps. If the lighting frequency is lower than or equal to the camera's frame rate, flickering will occur. It would be ideal for the illumination frequency to be an order of magnitude higher. Therefore, the 1kHz frequency (of the slower PWM) was chosen. Likewise, it will certainly be appropriate for the higher PWM frequency to be an order of magnitude higher than the slower PWM to suppress various transients. So 50kHz frequency was chosen. Here is a record of the simulation.

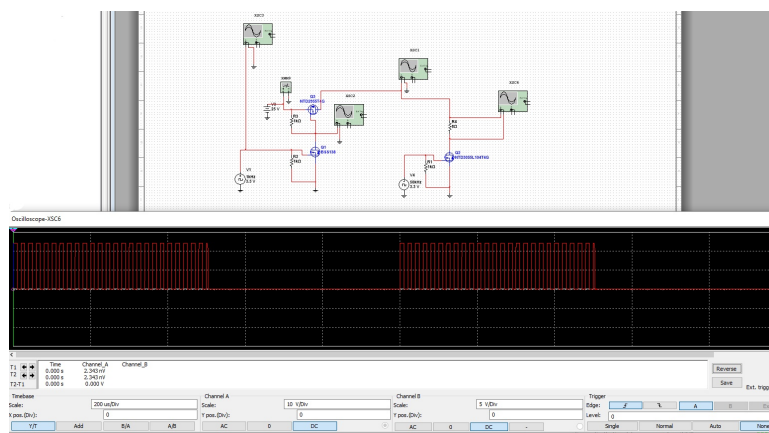

Figure 4.4: Multisim simulation

When the figure 4.4 is zoomed in, some delays in switching can be seen. Edges are not performed in zero time too. However, it is sufficient for this purpose and the selected components are suitable.

4.5 MCU

The requirements for the microcontroller are: generation of control signals for controlling the mentioned MOSFETs, so 3 GPIO pins capable of PWM generation. There is a need to control the AX12A servo motor, which communicates using a half-duplex UART. Figure 4.5 shows block diagram of required functions.

It would be ideal to have two different options for communication with the drone, either full-duplex UART or communication via USB. It may also be useful to have some other GPIO pins, possibly for other applications or board testing. Based on these requirements, the STM32F042K6T6 microcontroller was selected. This microcontroller is widely used in the MRS lab, which is also another advantage.

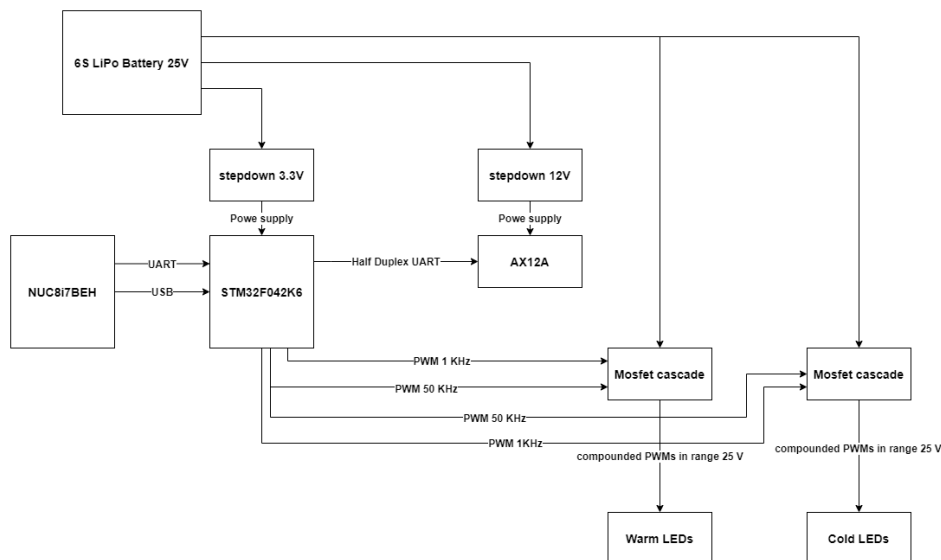

Figure 4.5: Block Diagram

4.5.1 Wiring diagram

The STM32CubeMX program was used while the wiring diagram was designed. The program allows us to select the right MCU and display the options of individual pins. Each pin has its list of functions for what it can be used for. Therefore, it is advisable to first set aside the pins for more specific functions.

First, the programming pins SYS-SWCLK and SYS-SWDIO was selected. The remaining pins for the programming connector are NRST, VDD, and GND, but they already have their location on the chip predetermined.

Although the selected chip has a built-in internal 16kHz oscillator, there was a preference to add an external oscillator to the chip. The external oscillator is more accurate and can also be used as a backup. Pins PF0 and PF1 were set as oscillator pins.

The mentioned PWMs could be implemented using an ordinary GPIO pin and a suitable program, which is unnecessary in this case. Selected MCU can generate PWM using a timer. In the "Timers" section a suitable timer was selected in such a way that pins will not collide with the already selected pins. In the TIM1 tab PWM, Generation was selected for both of its channels. These pins will serve as a light color control.

In the TIM2 tab PWM Generation was also selected for both of its channels but with only one needed. The second channel will be here added as a backup pin. Lastly, 3 GPIO pins were chosen. They were placed on PA1, PB1, and PB4. Entire pinout can be seen in figure 4.6.

4.5.2 Kicad Diagram

The PCB was designed in the kicad program. Firstly, the appropriate peripherals to the pins of the selected MCU should be connected. The required information was obtained from the application note [20]. Each VDD pin needs to have at least one 100nF decoupling capacitor. In total, one 10uF capacitor to supply should also be implemented. Capacitors are used here to cover peaks consumption of MCU. Using the application note [21], the components of the external oscillator was designed.

It is advisable to add USB protection to the pins from the USB. The USBLC6-2SC6 chip was chosen [17], which should protect the USB Pins from electrostatic discharge.

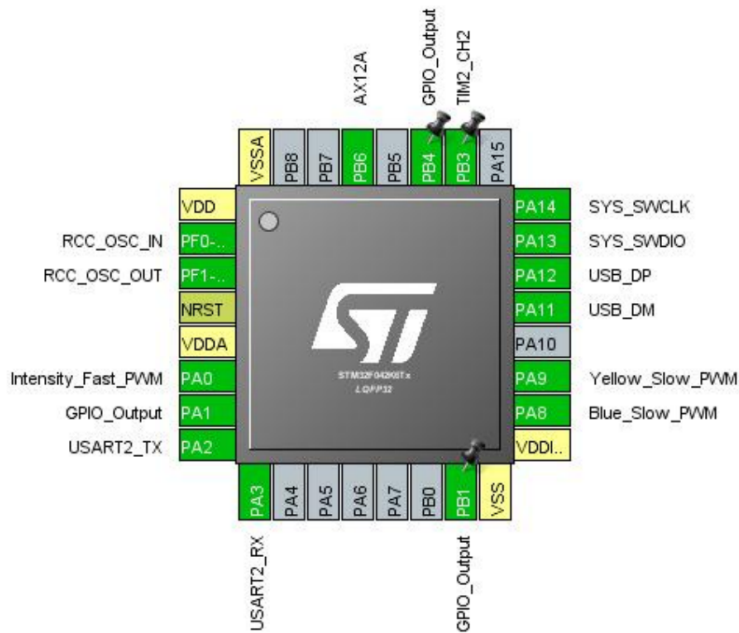

Figure 4.6: Diagram

4.5.3 Programming connector

To upload a program from the computer to selected MCU, some intermediate device is needed. In the case of the STM32 series, it is an ST-link. It can be purchased as a standalone device but is also built-in in the NUCLEO development boards. In Figure 4.7, the St-link is highlighted by a red frame.

There is a 6-pin SWD programming connector in the front part of the NUCLEO development board. It includes VDD, SWCLK, GND, SWDIO, NRST in this order. The sixth pin is SWDO, which is used for feedback communication. However, this pin is not supported by selected STM32F042K6T6 and is not even needed for the application. SWD programming connector is highlighted by yellow frame in figure 4.7.

As a programming connector 5-pin header connector with a pitch of 2.54 mm will be used. The pins in it are arranged in the same way as in the NUCLEO board. Thus: VDD, SWCLK, GND, SWDIO, NRST. A 165 resistor is placed between the connector and the MCU by the SWCLK, SWDIO and NRST pins. It acts as an overcurrent protection. If these pins are short-circuited, the current flowing through these resistors will be limited to 20mA at a voltage of 3.3V. Any GPIO pin can handle 25mA as a maximum current according to datasheet [19]. Should a short circuit occur, these resistors will limit the

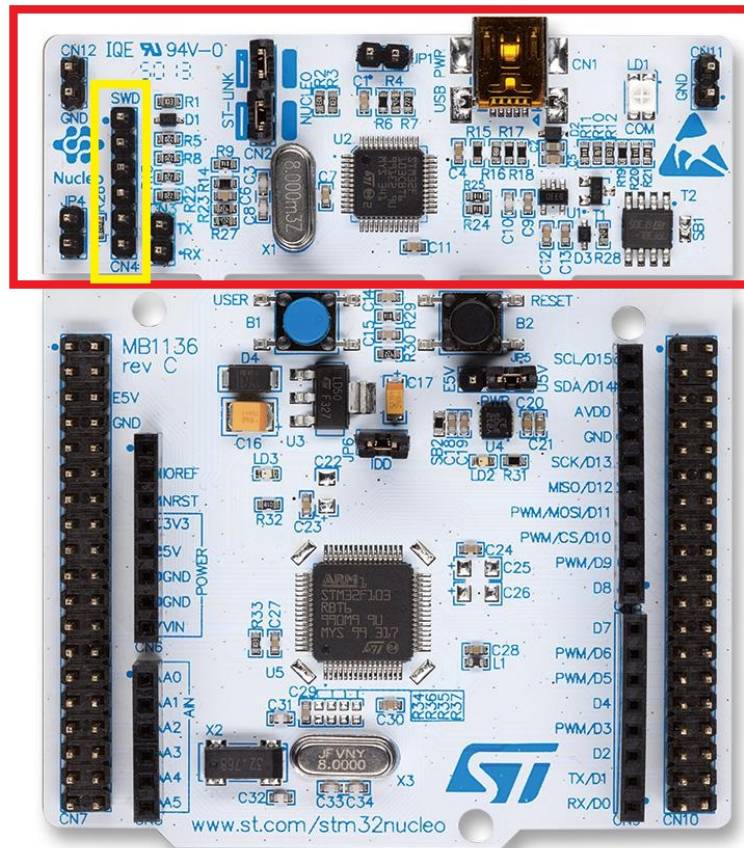

Figure 4.7: ST-link included in NUCLEO board

current to 20mA. As a result, the chip remains undamaged. Selected MCU also can switch to programming mode, where it is possible to upload code directly via USB. It is called DFU mode. However, USB is planned to be used to communicate with the drone. The program will be uploaded by the SWD connector via the NUCLEO board. DFU is therefore unwanted. To turn it off, pin PB8 needs to be connected via a 10kohm pull-down resistor to the ground. Which is based on the user manual UM1956[20].

4.6 Power sources

The system contains several substructures that need to be supplied with different voltages. The power supply of the LED panel is 6S LiPo Battery and there is no need to design its power source for it. However, there is a need to power the MCU itself and also the AX12A.

■ 4.6.1 MCU power source

The STM32 needs a 3.3V DC power supply. It is possible to use a linear regulator, but it is inefficient, especially with such a large voltage drop. So step-down converter or buck-converter is more preferred. It is known from the documentation[19] that the consumption of STM32F042 will probably not be higher than 100mA. However, the converter was oversized to 1A for reliability. It is redeemed at a slightly higher price, which in this particular case is negligible due to the price of the drone and its equipment.

The step-down converter generally works as follows: There is a switch in the main control chip, which opens/closes at a variable frequency. So it creates something like a PWM with an input voltage range. In the first phase: This PWM passes through the coil, and there is a voltage drop across it. At the same time, the block capacitors behind the coil are charged. The current returns from the load directly to the ground.

Second phase: The switch is closed, but energy is accumulated in the coil, pushing the current further and maintaining voltage. Decoupling capacitors help us to cover the current consumption. The current returns through the diode to the coil.

This process is constantly repeated and thanks to that it is possible to maintain the necessary voltage at the output of the converter. The circuit includes feedback, which determines the switching frequency. The ratio between resistors R15 and R16 determines the magnitude of the output voltage [9]. LMR2363DADDAR [23] was used as the main chip of the converter. The schematic and real implementation of MCU power supply can be seen in figure 4.8.

■ 4.6.2 AX12A power source

The AX12A servomotor should be powered by 12V. The maximum current consumption can be 1.5V according to documentation[15]. For the possibility of connecting another servomotor, the power supply was therefore designed to 3.5A current. A buck-converter was chosen as in the previous case. Compared to the previous converter, however, it will generally be more powerful.

A TPS54360DDA converter was selected. The circuit was designed according to the datasheet[22]. Schematic can be seen in figure 4.9a. The connection principle is similar to the previous case, but this time the rectifier diode is physically located outside the regulator. It is necessary to choose a power rectifier diode that can withstand a current of 3A.

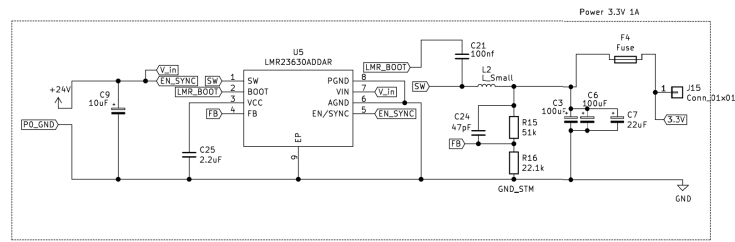

(a) : Schematic

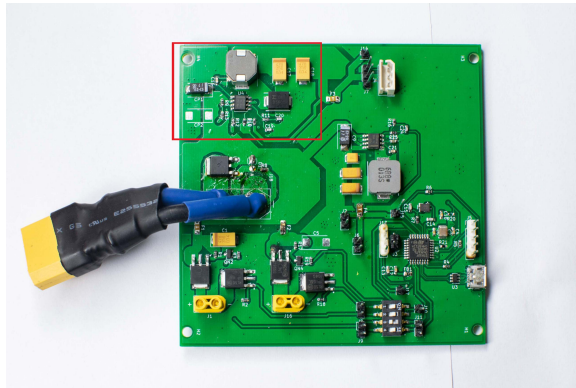

(b) : Real implementation

Figure 4.8: MCU power source

When selecting coils for both circuits, it is necessary to pay attention to its resistance and the associated maximum possible flowing current. If a larger current passes through the coil than it is rated for, the coil would start to heat up and could burn.

Tantalum capacitors were chosen for the circuit of both buck-converters. Compared to electrolytic capacitors, they are a bit more expensive but have a longer service life. It was also easier to achieve the required ESR. The resistors were selected in a 0603 SMD package. The wiring diagrams were created using the online script WEBENCH[24]. Figure 4.9b shows AX12A power source section in the PCB.

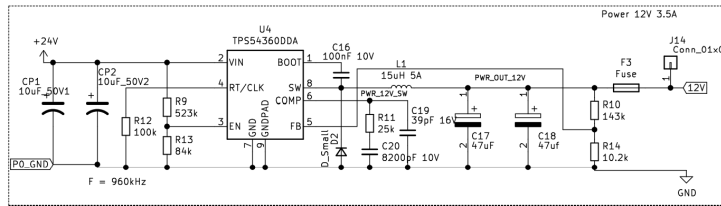

(a) : Schematic

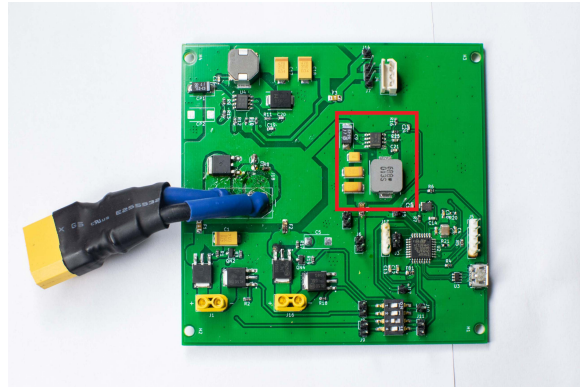

(b) : Real implementation

Figure 4.9: AX12A power source

4.7 Protections

Various protections were included in the design of the PCB. It is important to prevent components from damage in the event of an unintentional operation. If the power cables are swapped, several parts may be damaged at once. Therefore, reverse polarity protection has been added between the supply voltage input (see figure 4.10). This was realized by connection with P-MOSFET transistor [12] and zener diode [4].

Moreover, several fuses were included in the circuit. These can save the PCB in the event of an accidental short-circuit of some parts. A 1A fuse was placed on the output of the buck-converter for STM32. A 3A fuse has been added to the AX12A buck converter. A 4A fuses were placed in front of the MOSFETs controlling the individual branches leading to the LED panel. Originally, replaceable fuses were considered, but solderable fuses were eventually given here because of two reasons. The drone will generate vibrations during the flight, so it will be better if the contacts would be soldered. The second reason is that fuses are defined by current value at a given voltage.

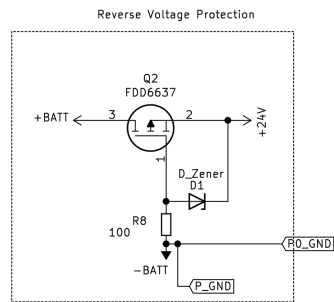

(a) : Schematic

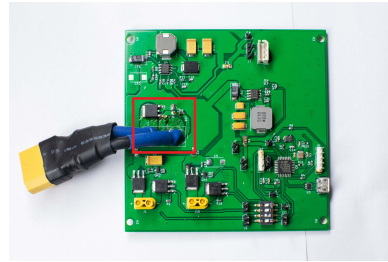

(b) : Real implementation

Figure 4.10: Reverse polarity protection

Replaceable fuses are usually designed for cars or larger systems where higher voltages occur, eg 120V. The current required for the fuse to blow is usually an order of magnitude higher than this case need. However, solderable fuses could be obtained relatively tailored to the requirements, at an affordable price.

4.8 PCB layout

During the design, it was important to take into account the current load of the individual conductors. A PCB trace width calculator[1] was used to calculate the minimal trace width. According to it, the final thickness of the copper traces was designed even with an added margin. For the correct design of the buck-converter, it is important to know the principle of the device.

It is important to keep the power traces that are not DC as short as possible. If not, the trace could act as an antenna. This could create significant interference that would affect the rest of the circuit. Inductors should be as far apart as possible so that no voltage is induced between them and do not function as a transformer.

Especially when designing power sources, it was important to follow all the rules. The datasheets [22] and [23] were followed when designing the PCB layout of power sources. The bottom layer of the PCB contains the ground plane.

This procedure is often used in the design and is used to suppress interference and loop currents. In the upper part, several supply zones have been created for the power parts to lose as little heat as possible on these conductors. The rest of the upper layer was also filled with grounding copper.

The components connected by power traces were placed as close as possible. The location of the components corresponds to the blocks in the diagram.

The board has 100x100mm which was a requirement for its maximum size. It has mounting holes deliberately designed so PCB can be attached between Intel NUC8i7BEH PCB[7] and lidar.

The XT90 connector was selected to power the board, which is also connected to the "GENS ACE LIPO TATTU - 6S 7000 mAh 22,2V" battery. To power the LED panel, XT30 connectors were chosen for each branch. For the power supply and control of the AX12A servomotor, the Molex SPOX 5267 3 pins connector was selected, which already fits directly to cables assigned to the selected servomotor. There is a 4-channel switch on the board. This gives the possibility to disconnect individual signals leading from the MCU to the control MOSFETS.

It is incorporated due to the possibility of "debugging the board", where it is possible to independently measure the output from the MCU with an oscilloscope. There is an extra possibility to switch MOSFETs from another source. When incorporating a PB4 pin, it is also possible to exchange PWM source pins.

The PCB was soldered with a solder mask and solder paste in the MRS lab. The soldered pcb is shown in figure 4.12.

The following figures 4.11 shows the diagram of the whole circuit, the layout of the PCB, the 3D model of the PCB, and photographs.

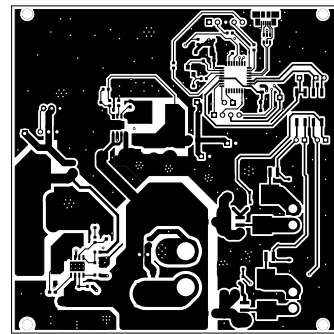

(a) : Front layout of PCB

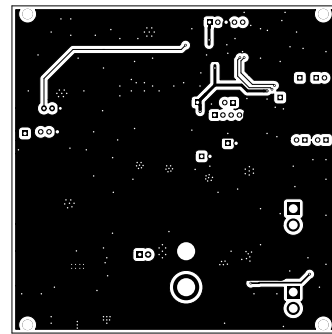

(b) : Back layout of PCB

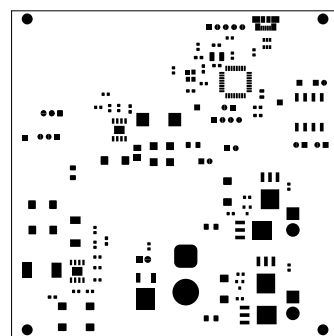

(c) : Layout of Pads

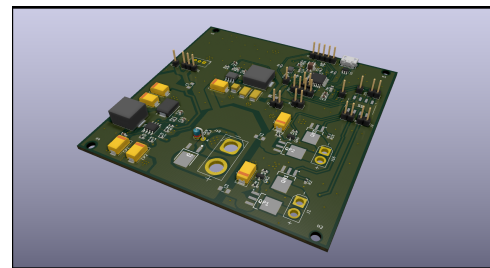

(d) : 3D visualization

Figure 4.11: PCB overview

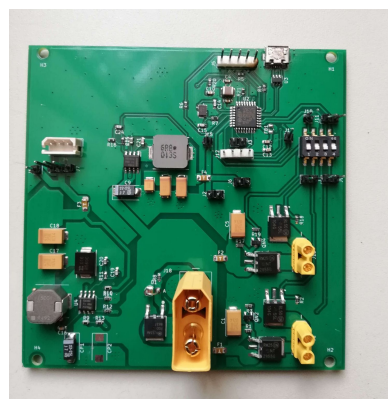

(a) : Soldered PCB

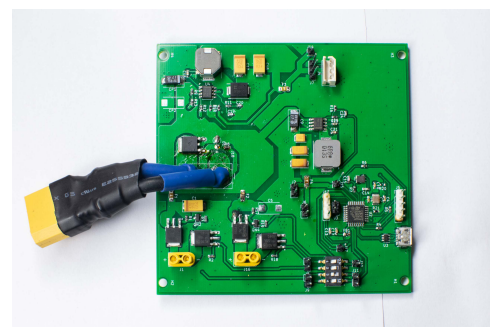

(b) : Modified power cables

Figure 4.12: Soldered PCB

Chapter 5

Software and Firmware Implementation

5.1 Introduction

The NUC8i7BEH control computer is installed on the drone. It runs Ubuntu 18.04, which receives commands from the control computer via SSH. The entire MRS system is already located on the disk of NUC8i7BEH. But it is necessary to add there the control packages.

Communication with the PCB takes place via UART, so an USB/UART converter is required. Although the PCB is prepared to communicate directly via USB, UART is used in this implementation. In the future, it is planned to equip the drone with a multiple channel UART/USB converter, so it seemed like a better option. The on-board computer needs to send data through serial communication to the converter. It is also advisable to have a program that simplifies our control. This can be done in ROS with two nodes. The first node is the subscriber of the reserved topic and sends everything it receives via serial communication. This node is already part of the MRS system and only needed to be modified. The second node is the control program. This node receives a simple command, processes it, and publishes it to a reserved topic.

In this case, they are specifically named **mrs_serial** and **mrs_sidelight_controller**.

ROS topic is named: **/serial_light/send_message**.

The control procedure is as follows: User calls the function from the **mrs_sidelight_controller** node. Control node gives a message to **mrs_serial**

node via ROS. Node `mrs_serial` send data into USB serial port. Then data is converted by UART convertor. A program running on STM32 processes the message and performs the required action. For example, changes the duty cycle of 50KHz PWM. Control procedure can be seen in Communication diagram 5.1.

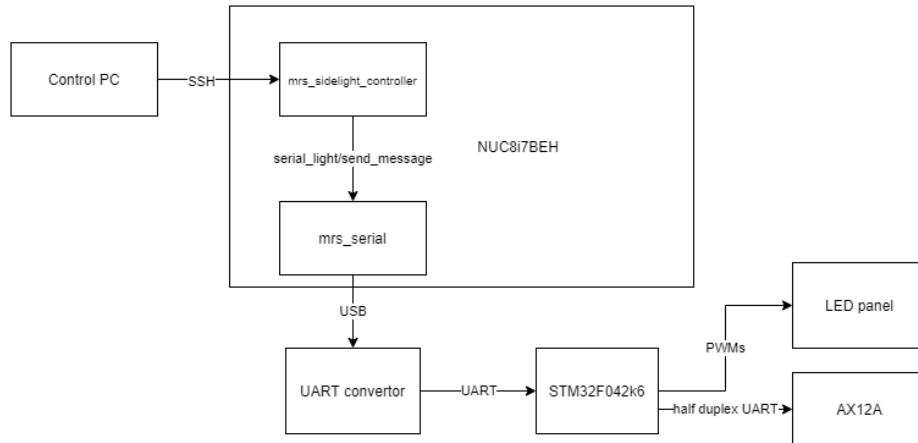

Figure 5.1: Communication diagram

5.2 On-Board Computer Software Implementation

The basic principle has already been mentioned in the introduction. The knowledge essential for the implementation of this application into the ROS system was obtained mainly from the book [8]. The control procedure is as follows:

Nodes `mrs_serial` and `mrs_sidelight_controller` are launched by `roslaunch` command. To set up communication, it was necessary to insert our UART convertor into Udev rules. The `mrs_serial/BacaProtocol.msg` protocol, shown in Table 5.1, was used to transfer information between the two nodes.

line		
1	time stamp	
2	uint8[]	payload
3	uint8	checksum_correct calculated
4	uint8	checksum_received
5	bool	checksum_correct

Table 5.1: `mrs_serial/BacaProtocol.msg`

The first byte of the payload indicates the message id. When creating these functions, it was important to design their id so that it was unique and did not conflict with any other function that is located in the drone. Additional bytes can carry specific values needed for a given application. Only one extra byte is required for this application.

In the node `mrs_sidelight_controller` was implemented 3 rosservice functions. Using each of these functions, it is possible to control a different part of the device.

When calling rosservice `/uav1/sidelightcontroler/intensity_change` function, it is possible to change the light intensity. When calling the mentioned function, it is necessary to add a parameter that will determine the rate of intensity. In this case, the range is 0-100, which indicates the illumination rate in percent. If a value that is out of range is entered in the argument, the program reports the wrong argument. The id of the message is 0x91. The checked value of the argument is written to the second byte of the payload.

When calling rosservice `/uav1/sidelightcontroler/color_change` function, it is possible to change the light's color temperature. The range here is 0-200. If a value that is out of range is entered in the argument, the program reports the wrong argument. This value indicates the color temperature in kelvins. When the color temperature is set to 100, the value of neutral white illumination is set (5500K). When the color temperature is set to 0, the coldest color temperature of light is set. It should correspond to around 2000K color temperature. The warmest color temperature (value 200) should correspond to around 7000K. The id of the message is 0x92. The checked value of the argument is written to the second byte of the payload.

When calling the rosservice `/uav1/sidelightcontroler/angle_change` function, it is possible to change the rotation angle of the LED panel. The AX12A servomotor currently operates in the range of 0-300 degrees. This means it is possible to rotate the LED panel by 100 degrees due to conversion ratio of 3:1. The degree parameter must therefore be in the range 0-100. If a value that is out of range is entered in the argument, the program reports the wrong argument. The id of the message is 0x93. The checked value of the argument is written to the second byte of the payload.

Exact examples of rosservice calls are described below:

Command `rosservice call /uav1/sidelightcontroler/intenzity_change 25` set intensity to 25%.

Command `rosservice call /uav1/sidelightcontroler/color_change 100` set color temperature to 5500K.

Command **rosservice call /uav1/sidelightcontroler/angle_change 55** turn LED panel by 55 degrees according to base position.

When one of these functions is called, the appropriate operations are performed, and the message is published to topic `/serial_light/send_message`. The mentioned `mrs_serial/BacaProtocol.msg` message type shown in table 5.1 is used here for communication. The node `mrs_serial` receives the message, modifies it according to the serial protocol (shown below), and forwards message via serial communication.

Node `mrs_serial` has predetermined serial protocol:

```
['b'][payload_size][payload_0(=message_id)][payload_1]...[payload_n][checksum]
```

For our purpose only 2 data bytes are needed. First byte indicates id of service. Second byte carry the value. A total of 5 bytes are sent. Based on these requirements, a program for STM32 can be designed.

5.3 Microcontroller Firmware Implementation

CubeMX was used to design the pin layout. But CubeMX can also be used for code generation. This code contains all the necessary information to set the pins. Then the control code was written into the base code. A reference manual [18] and [10] were an essential source information.

The program distinguishes three types of messages: each message has a length of 5 bytes. The first byte is derived from the serial protocol. Its value should always be "b". The second byte contains information about the length of the message. In our case, this value should always be 5, like 5 bytes. The third byte defines the type of message, while the fourth byte contains the value. The value of the fifth byte is used for the checksum.

An interrupt is generated if UART receives exactly 5 bytes. According to the value contained in the third byte, the program determines the type of message. If this value is 0x91, it is an intensity_change message. In the case of intensity_change message, the value of the fourth byte is checked and then remapped to the entire PWM range.

If this value is 0x92, it is a color_change message. In the case of color_change message, the value of the fourth byte is checked and then used for a following calculation.

$$pulse_warm = (max_counter_color - 1) * (balance + 100)/200; \quad (5.1)$$

$$pulse_cold = (max_counter_color - 1) * (-(balance - 100))/200; \quad (5.2)$$

Where *max_counter_color* is associated with PWM range. Variables *pulse_warm* and *pulse_cold* are duty cycle variables of PWMs.

If this value is 0x93, it is an angle_change message. When receiving angle_change message, fourth byte value is checked and then remapped to servo range. Servo receives value in the range 0-1024. By default, the AX12A servo is designed to operate in the range of 0-300 degrees. As the LED panel is rotated through the gear mechanism, there is a 3:1 gear ratio. This means that the light can rotate a maximum of 100 degrees. However, it is the possibility to switch the AX12A to continuous mode. This would allow the light to rotate without limits. This may be one of the suggestions for improving the existing device.

The whole code can be found in the attachment list. The diagram 5.2 describes the principle of the program.

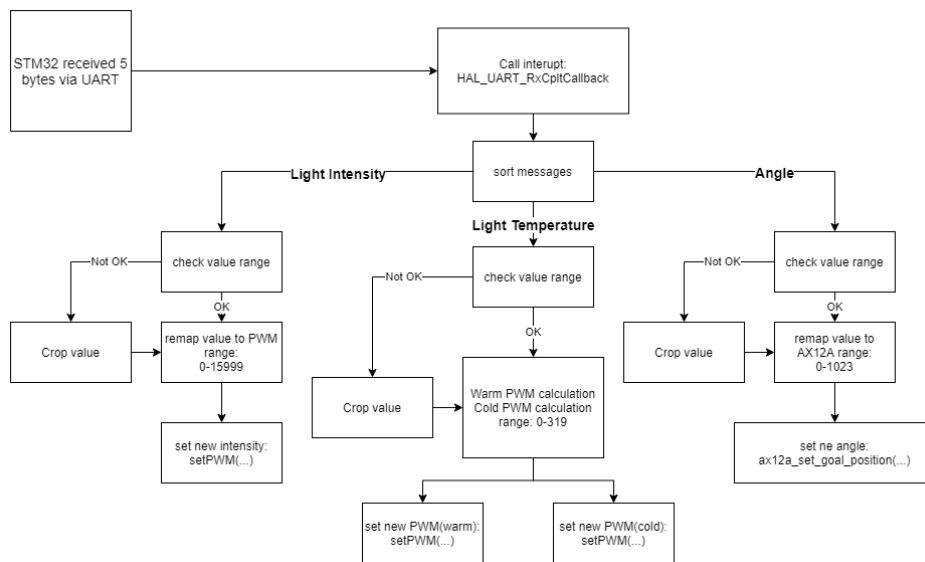

Figure 5.2: STM32 program diagram



Chapter 6

Experiments

First, the individual parts were tested. This phase, along with programming, was relatively complex and involved many debugging and fixes. Finally, all parts are put into operation. Then the system gradually began to be mounted on the Tarot 650 platform. During this phase, it was found that it would be better to insert a cable between the PCB and the XT90 connector as shown in figure 4.12b. Thanks to this, it is possible to place smaller spacers under the lidar holder. A splitting Y cable providing power to the drone and the PCB was made. Subsequently, the whole system was assembled and installed on the Tarot 650 platform.

The first flight took place on the CTU campus on Charles Square in the MRS training area behind the building. The course of the first flight is captured in the photos 6.1 below.

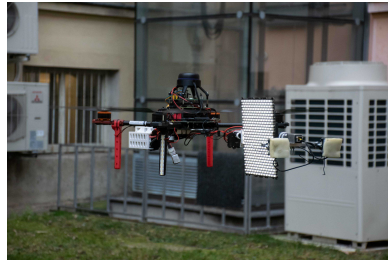

(a) : Take off



(b) : color change during wall attachment



(c) : intensity change during wall attachment attempt



(d) : Whole drone in terrain

Figure 6.1: First Flight

However, tilting the LED panel was disabled on the first flight. It has been fixed and braided sleeving were added to the cables. Then the second flight took place (see figure 6.2).

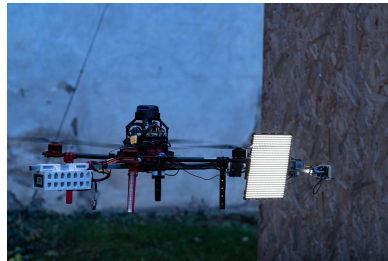

(a) : Intensity 10%, neutral temperature 5500K



(b) : Tilting the LED panel

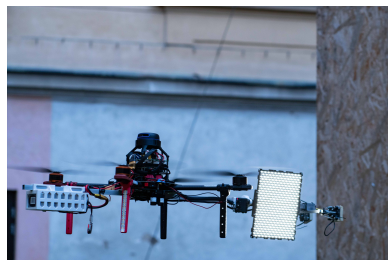

(c) : Intensity 10%, cold temperature

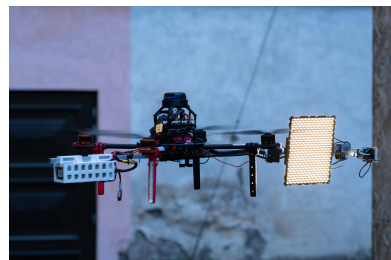

(d) : Intensity 10%, warm temperature

Figure 6.2: Second Flight

On the second flight, everything went well. It was possible to control the drone from the control computer. It was possible to change the light intensity



(a) : Intensity 100%, neutral temperature 5500K

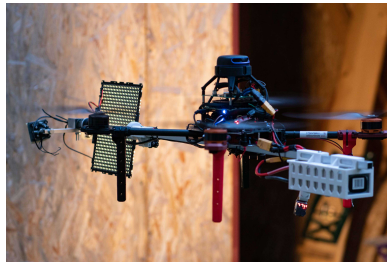

(b) : Rear view

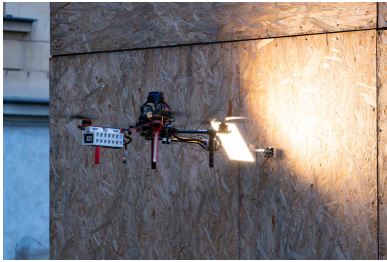

(c) : Intensity 100%, tilting



(d) : Intensity 100%, tilting

Figure 6.3: Attachment to wall attempt

shown in figures 6.2a 6.3a, change the light temperature shown in figure 6.2c 6.2d and rotate the LED panel shown in figures 6.3c 6.3d. The system captures photos with many possible settings. Also exist a camera recording of this flight. The drone was piloted by Pavel Petráček, who also tested the first prototype. It was confirmed that this second prototype has significantly better handling.

It is worth mentioning that the CSWW system was not turned on in these experiments. Its involvement and use do not belong in this bachelor's thesis. The final design of the finished system is captured in the figures 6.4 below. The whole system is captured in figure 6.5.

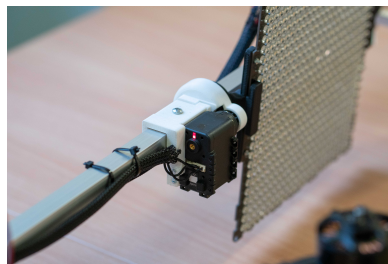

(a) : AX12A attachment



(b) : LED panel detail, cold temperature

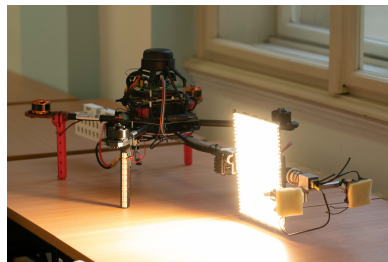

(c) : LED panel detail, warm temperature

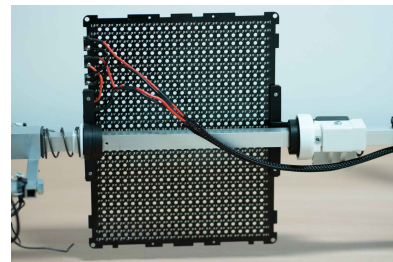

(d) : LED panel attachment

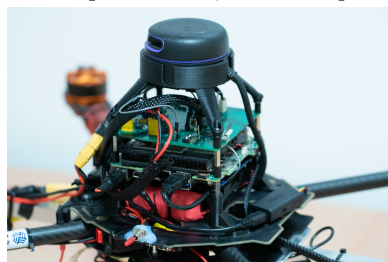

(e) : PCB assembly detail



(f) : The whole system

Figure 6.4: Details



Figure 6.5: The whole system



Chapter 7

Conclusions

A functional side lighting system was designed for the UAV. A mechanical system capable of ensuring safe contact of the drone with the wall was implemented. Therefore, it is possible to place the light source directly at the wall and thus illuminate the scene vertically without restriction.

Thanks to the design, it is possible to position the light around one axis at all angles, without any shading caused by another part of the system. A 3D model of the whole system was also created. Due to the fact that a substantial part is assembled using 3D printing, it is not a problem to replicate the whole system.

As part of the development of the first prototype, it was tested that the concept is light enough for the drone to carry it, and at the same time, it is strong and robust enough. As part of the development of the second prototype, significant improvements were made, which made it possible to reduce the weight of the entire system and improve its dynamics. From the original weight of 1695 g, in the first prototype, it was possible to get to 1153 g weight.

When designing the device, the connection of the CSWW system was taken into account. The device is fully prepared for its connection, including routed cables and other requirements which was respected.

Custom PCB was designed to control the light. The PCB controls changing light intensity, changing light temperature, as well as controls a tilt of the light, using the STM32F042K6T6 microcontroller.

The microcontroller communicates with the on-board computer using UART. The PCB also provides power for the microcontroller and the AX-12A servo-motor. The mentioned power sources are tailor-made for the accessories.

Communication between devices was fully ensured. On-Board computer software has been modified for the application. The necessary packages have been implemented in the ROS system. The device is fully compatible with the MRS Group system. Microcontroller firmware was also implemented. The system was successfully tested in real conditions. It is possible to adjust the light temperature, lighting intensity, and tilt of the LED panel during the flight.

During the development of the thesis, it was necessary to deal with problems in programming, construction, and electrical engineering.

A possible improvement could be to put together the electronics from the CIWW system and light control electronics into a single PCB.

Replacing the aluminum profile with a carbon tube could have the potential. Here is, however, a question of whether there would be a weight loss because the square profile gives us significant design advantages. For a carbon tube, we would have to include other structural elements that would add some weight.



Appendix A

Bibliography

- [1] Advanced Circuits. Trace width calculator. <https://www.4pcb.com/trace-width-calculator.html>, 2020.
- [2] CTU. Micro aerial vehicles - platforms. <http://mrs.felk.cvut.cz/research/micro-aerial-vehicles>, 2020.
- [3] Daniel Smrcka. Controlled interaction of an unmanned aerial vehicle with a wall. <https://dspace.cvut.cz/handle/10467/82237>, 2019. BACHELOR'S THESIS.
- [4] Electronic Design. Reverse-polarity protection in automotive design. <https://www.electronicdesign.com/power-management/article/21801509/reversepolarity-protection-in-automotive-design>, 2016.
- [5] M. Freeman. *Photographer's Eye*. Octopus Publishing Group, 2007.
- [6] HITEC. Hitec hs-311 eco bulk. https://www.pelikandaniel.com/dld/navod_serva_hitec.pdf, 2016.
- [7] Intel. Intel® nuc kit nuc8i7beh. <https://ark.intel.com/content/www/us/en/ark/products/126140/intel-nuc-kit-nuc8i7beh.html>, 2020.
- [8] A. Koubaa. *Robot Operating System (ROS), The Complete Reference (Volume 3)*. Springer, 2018.
- [9] D. G. Lamar, P. F. Miaja, M. Arias, A. Rodríguez, M. Rodríguez, and J. Sebastián. A project-based learning approach to teaching power electronics: Difficulties in the application of project-based learning in

a subject of switching-mode power supplies. In *IEEE EDUCON 2010 Conference*, pages 717–722, 2010.

- [10] C. Noviello. *Mastering STM32*. Leanpub, 2018.
- [11] On Semiconductor. Bss138 n-channel logic level enhancement mode field effect transistor. <http://www.farnell.com/datasheets/2304519.pdf>, 2005.
- [12] On Semiconductor. Fdd6637 35v p-channel powertrench mosfet. <https://cz.mouser.com/datasheet/2/308/FDD6637-D-1807054.pdf>, 2015.
- [13] On Semiconductor. Ntd3055l104 power mosfet 12 a, 60 v, logic level nchannel. <http://www.farnell.com/datasheets/2354279.pdf>, 2016. DPAK/IPAK.
- [14] On Semiconductor. Ntd2955 power mosfet 60 v, 12 a, pchannel. <http://www.farnell.com/datasheets/2354114.pdf>, 2017. DPAK.
- [15] ROBOTIS. Dynamixel ax-12. <https://emanual.robotis.com/docs/en/dxl/ax/ax-12a/>, 2020.
- [16] M. Saska, V. Krátký, V. Spurný, and T. Báča. Documentation of dark areas of large historical buildings by a formation of unmanned aerial vehicles using model predictive control. pages 1–8, 2017.
- [17] STMicroelectronics. Usblc6-2. https://cz.mouser.com/datasheet/2/389/usblc6_2-1852789.pdf, 2011. Very low capacitance ESD protection.
- [18] STMicroelectronics. Rm0091 reference manual. https://www.st.com/resource/en/reference_manual/dm00031936-stm32f0x1stm32f0x2stm32f0x8-advanced-armed-32bit-mcus-stmicro.pdf, 2017.
- [19] STMicroelectronics. Stm32f042x4 manual. <https://www.st.com/resource/en/datasheet/stm32f042k6.pdf>, 2017.
- [20] STMicroelectronics. Um1956 user manual. https://www.st.com/content/ccc/resource/technical/document/user_manual/e3/0e/88/05/e8/74/43/a0/DM00231744.pdf/files/DM00231744.pdf/jcr:content/translations/en.DM00231744.pdf, 2018.
- [21] STMicroelectronics. An2867 application note. https://www.st.com/resource/en/application_note/cd00221665-oscillator-design-guide-for-stm8afals-stm32-mcus-and-mpus-stmicro.pdf, 2020. HSE.
- [22] Texas Instruments. Tps54360 60-v input, 3.5-a, step-down dc/dc converter. https://www.ti.com/lit/ds/symlink/tps54360.pdf?HQS=TI-null-null-mouser-mode-df-pf-null-wwe&ts=1605011440327&ref_url=https%253A%252F%252Fwww.mouser.de%252F, 2018.



Appendix B

List of Abbreviation

Abbreviation	Meaning
UAV	Unmanned aerial vehicle
CIWW	Controlled Interaction with Wall
SGWCS	Strain gauge with contact surface
ROS	Robot-Operating System
CTU	Czech Technical University
MRS	Multi-Robot Systems
MCU	Microcontroller Unit
PCB	Printed Circuit Board



Appendix C

CD Content

In Table C are listed names of all root directories on CD.

Directory name	Meaning
Thesis	The thesis in pdf format
PCB	kicad files os the custom PCB
STM32_Sidelight	control program for STM32F42K6T6
src/mrs_serial-master	modified MRS ROS package for serial communication
src/mrs_sidelight_controller	ROS package node for system control
3D_models/drawings	fusion360 files of designed system
3D_models/stl	stl files of designed system