

Příloha č. 6

C: Transient Structural
Equivalent Stress 12
Type: Equivalent (von-Mises) Stress
Unit: MPa
Time: 20
30.07.2020 16:24

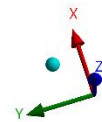
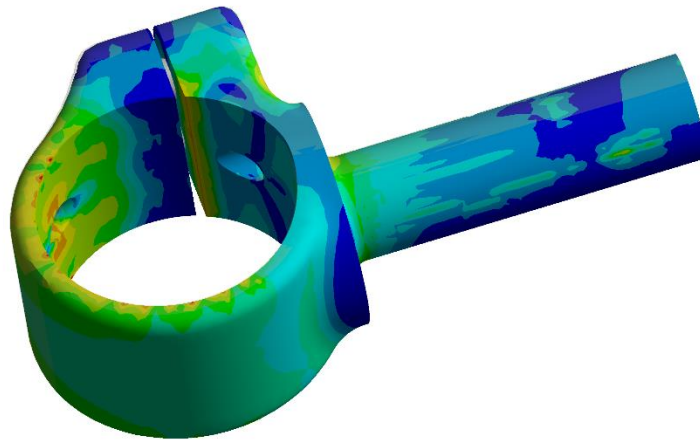
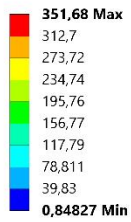

Příloha 6.1: Ekvivalentní napětí na spodním úchytu tlumičů

C: Transient Structural
Equivalent Stress 12
Type: Equivalent (von-Mises) Stress
Unit: MPa
Time: 20
30.07.2020 16:25

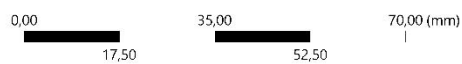
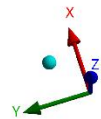
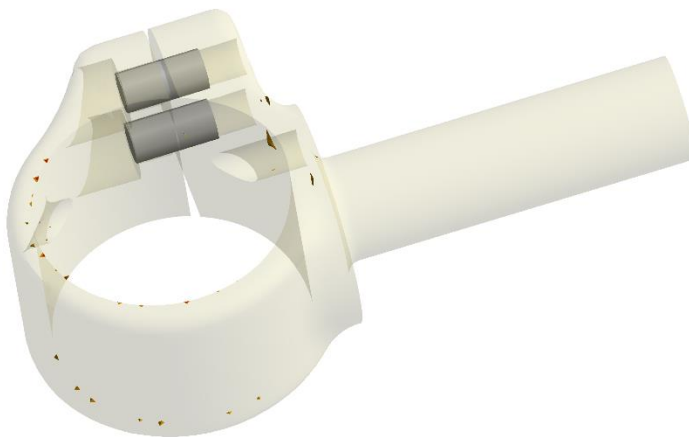
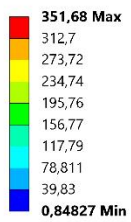

Příloha 6.2: Ekvivalentní napětí na spodním úchytu tlumičů vyšší než 290 MPa