



**CZECH TECHNICAL  
UNIVERSITY  
IN PRAGUE**

**F3**

**Faculty of Electrical Engineering  
Department of Control Engineering**

**Bachelor's Thesis**

# **Objective evaluation of a vehicle handling quality perception**

**Adam Konopiský**

**May 2020**

**Supervisor: Ing. Petr Liškář**





## I. Personal and study details

Student's name: **Konopiský Adam**

Personal ID number: **474448**

Faculty / Institute: **Faculty of Electrical Engineering**

Department / Institute: **Department of Control Engineering**

Study program: **Cybernetics and Robotics**

## II. Bachelor's thesis details

Bachelor's thesis title in English:

**Objective evaluation of a vehicle handling quality perception**

Bachelor's thesis title in Czech:

**Objektivní vyhodnocení vnímání jízdních vlastností vozidla**

Guidelines:

The primary objective of this thesis is to prepare a methodology base enabling objective evaluation of a passenger car control system based on subjective drivers' inputs and impressions.

The aim is to find a correlation between response of a dynamic system composed of a control system and vehicle model, measured data and human perception. This should help to define goals of a desired responses of advanced control systems, such as drive-by-wire, in order to be well accepted and admired by end users.

- 1) Get familiar with criteria used for subjective evaluation and control of dynamic systems and human-machine interface rating.
- 2) Prepare methodology, test platform and process of evaluation
- 3) Implement framework with dedicated simulation and test platform with a complete data acquisition, processing and input signals emulation
- 4) Test execution with data

Bibliography / sources:

[1] Dieter Schramm, Manfred Hiller, Roberto Bardini – Vehicle Dynamics – Duisburg 2014

[2] Hans B. Pacejka - Tire and Vehicle Dynamics – The Netherlands 2012

[3] Robert Bosch GmbH - Bosch automotive handbook - Plochingen, Germany : Robert Bosch GmbH ; Cambridge, Mass. : Bentley Publishers

Name and workplace of bachelor's thesis supervisor:

**Ing. Petr Liškář, Department of Automotive, Combustion Engine and Railway Engineering, FME**

Name and workplace of second bachelor's thesis supervisor or consultant:

**Ing. Tomáš Haniš, Ph.D., Department of Control Engineering, FEE**

Date of bachelor's thesis assignment: **10.01.2020**

Deadline for bachelor thesis submission: **22.05.2020**

Assignment valid until:

**by the end of summer semester 2020/2021**

\_\_\_\_\_  
Ing. Petr Liškář  
Supervisor's signature

\_\_\_\_\_  
prof. Ing. Michael Šebek, DrSc.  
Head of department's signature

\_\_\_\_\_  
prof. Mgr. Petr Páta, Ph.D.  
Dean's signature

## III. Assignment receipt

The student acknowledges that the bachelor's thesis is an individual work. The student must produce his thesis without the assistance of others, with the exception of provided consultations. Within the bachelor's thesis, the author must state the names of consultants and include a list of references.

\_\_\_\_\_  
Date of assignment receipt

\_\_\_\_\_  
Student's signature



## Acknowledgement / Declaration

First of all, I would like to thank my supervisor, Ing. Petr Liškář for excellent leadership and great advices.

Ing. Tomáš Haniš, Phd. has created innovative duo with Mr. Liškář and offered many helpful advices. I would also like to thank him for offering me an opportunity to work under his supervision at the summer project, which led to this work.

My thanks also belong to doc. Ing. Pavel Pačes, Ph.D., who answered all the questions about 6DOF platform.

I would also like to thank Tomáš Twardzik for forming great partnership and the time spent together.

I declare that the presented work was developed independently and that I have listed all sources of information used within it in accordance with the methodical instructions for observing the ethical principles in the preparation of university thesis.

In Prague,

.....

## Abstrakt / Abstract

Tato bakalářská práce se zabývá problematikou objektivního vyhodnocování vnímání jízdních vlastností vozidla. Motivací pro tuto práci je najít korelaci mezi telemetrickými signály a subjektivním hodnocením řidiče. Tato práce by měla v budoucnu pomoci ve vývoji automobilových systémů jako je drive-by-wire a v přechodu k plně autonomním vozidlům.

V úvodu se práce zabývá kritérii pro subjektivní hodnocení. Mapuje jednotlivé hodnotící škály, které se v minulosti používali nebo stále používají, jak v automobilovém, tak v leteckém průmyslu. Přichází s metodologií vyhodnocování jízdních vlastností, která vychází z upravené Cooper-Harper škály.

V této práci je popsána implementace struktury programů, které jsou využity pro komunikaci mezi automobilovým simulátorem Live for Speed, Simulinkovým modelem a 6DOF platformou, která je k dispozici na ČVUT. Tyto programy nám umožňují kompletní sběr jízdních dat a jejich následnou analýzu.

Poslední část je věnována samotnému testování na pohyblivé platformě a vyhodnocení sesbíraných dat a subjektivních hodnocení.

**Klíčová slova:** kvalita ovládání; drive-by-wire; objektivní vyhodnocení; autonomní řízení.

**Překlad titulu:** Objektivní vyhodnocení vnímání jízdních vlastností vozidla

This bachelor thesis deals with the topic of an objective evaluation of a vehicle handling quality perception by the drivers. The motivation is to find a correlation between the telemetry signals and the subjective evaluation of the driver. It should help in the future advancement of systems such as drive-by-wire and in the transition to the fully autonomous cars.

In the introduction, this thesis focuses on the criteria for subjective evaluation. It maps the rating scales used both in automotive and aircraft industry and develops a new methodology based on the modified Cooper-Harper scale.

In this thesis is described an implementation of a framework used for the communication between a Live for speed car simulator, Simulink model, and 6DOF platform that is available at CTU. This framework allows a complete telemetry data acquisition and post-driving analysis.

The final part deals with the testing on the 6DOF platform and evaluates the collected data and subjective rankings.

**Keywords:** handling quality; drive-by-wire; objective evaluation; autonomous driving.

# Contents /

<b>1 Introduction</b> .....	1	4.3 Thrustmaster wheel and pedals.....	20
<b>2 Theoretical part</b> .....	3	4.3.1 6DOF platform .....	20
2.1 Vehicle handling .....	3	4.4 Matlab/Simulink.....	21
2.2 Subjective and objective evaluation of vehicle handling ...	3	4.4.1 UDP receive/send blocks.....	22
2.2.1 Subjective evaluation .....	3	4.5 Live for speed options .....	22
2.2.2 Objective evaluation .....	4	<b>5 Tests execution</b> .....	23
2.3 Rating scales used in automotive .....	4	5.1 Testing process.....	23
2.3.1 Bergman scale.....	4	5.2 Data collection .....	24
2.3.2 Weir and DiMarco rating scale .....	5	5.3 Pearson correlation coefficient .	24
2.3.3 Matsushita and Sano approach .....	5	5.4 Evaluation.....	25
2.3.4 K�ppler two-level sequential judgement scale ..	6	5.4.1 Passenger testing .....	27
2.3.5 David Chen’s rating scale ..	6	<b>6 Conclusions</b> .....	28
2.4 Fly-by-wire concept .....	7	<b>References</b> .....	30
2.4.1 Motivation for fly-by-wire .....	7	<b>A Glossary</b> .....	33
2.4.2 Advantages of fly-by-wire ..	8	<b>B Ride logs</b> .....	34
2.5 Drive-by-wire concept .....	8	<b>C Car information</b> .....	56
2.5.1 Steer-by-wire .....	9		
2.5.2 Brake-by-wire .....	9		
2.5.3 Throttle-by-wire .....	10		
<b>3 Methodology</b> .....	11		
3.1 Cooper-Harper .....	11		
3.1.1 Cooper-Harper diagram .	12		
3.1.2 Czech version of Cooper-Harper diagram .	13		
3.2 Questionnaire .....	14		
3.3 LFS environment .....	14		
3.3.1 Skidpad.....	14		
3.3.2 Double-lane change .....	15		
<b>4 Framework</b> .....	17		
4.1 Framework outline .....	17		
4.2 Python .....	18		
4.2.1 Connection from LFS to Python .....	18		
4.2.2 .Csv possibilities .....	18		
4.2.3 Controller functions.....	18		
4.2.4 Platform functions .....	19		
4.2.5 Transform functions .....	19		
4.2.6 Available real-time signals .....	19		

## Tables / Figures

<p><b>5.1.</b> Questionnaire answers ..... 24</p> <p><b>5.2.</b> Pearson correlation table ..... 25</p>	<p><b>2.1.</b> Rating scales timeline.....4</p> <p><b>2.2.</b> Bergman rating scale .....5</p> <p><b>2.3.</b> Satisfactory vehicle response ....5</p> <p><b>2.4.</b> Subjective rating in various lane change distances .....6</p> <p><b>2.5.</b> Chen rating scale.....7</p> <p><b>2.6.</b> Signal flow in fly-by-wire aircraft.....7</p> <p><b>2.7.</b> Steer-by-wire scheme.....9</p> <p><b>2.8.</b> Brake-by-wire scheme ..... 10</p> <p><b>3.1.</b> Original Cooper-Harper rating scale ..... 11</p> <p><b>3.2.</b> Cooper-Harper diagram..... 12</p> <p><b>3.3.</b> Czech version of Cooper-Harper diagram ..... 13</p> <p><b>3.4.</b> Skidpad layout ..... 14</p> <p><b>3.5.</b> Skidpad layout in simulator ... 15</p> <p><b>3.6.</b> Double-lane change maneuver scheme..... 15</p> <p><b>3.7.</b> Double-lane change maneuver in simulator ..... 16</p> <p><b>4.1.</b> Framework outline ..... 17</p> <p><b>4.2.</b> Thrustmaster control panel.... 20</p> <p><b>4.3.</b> 6DOF Platform ..... 21</p> <p><b>4.4.</b> 6DOF Platform in motion ..... 21</p> <p><b>4.5.</b> Example of car adjustability... 22</p> <p><b>5.1.</b> Passenger version of Cooper-Harper diagram ..... 23</p> <p><b>5.2.</b> Reference ride - steering ..... 26</p> <p><b>B.1.</b> Steering deviation: 7.583 ..... 34</p> <p><b>B.2.</b> Yaw rate deviation: 0.084 ..... 34</p> <p><b>B.3.</b> Steering deviation: 23.9..... 35</p> <p><b>B.4.</b> Yaw rate deviation: 0.127 ..... 35</p> <p><b>B.5.</b> Steering deviation: 2.26..... 36</p> <p><b>B.6.</b> Yaw rate deviation: 0.023 ..... 36</p> <p><b>B.7.</b> Steering deviation: 9.32..... 37</p> <p><b>B.8.</b> Yaw rate deviation: 0.023 ..... 37</p> <p><b>B.9.</b> Steering deviation: 9.612 ..... 38</p> <p><b>B.10.</b> Yaw rate deviation: 0.094 ..... 38</p> <p><b>B.11.</b> Steering deviation: 19.01 ..... 39</p> <p><b>B.12.</b> Yaw rate deviation: 0.19..... 39</p> <p><b>B.13.</b> Steering deviation: 1.843 ..... 40</p> <p><b>B.14.</b> Yaw rate deviation: 0.026 ..... 40</p> <p><b>B.15.</b> Steering deviation: 11.457 ..... 41</p> <p><b>B.16.</b> Yaw rate deviation: 0.067 ..... 41</p> <p><b>B.17.</b> Steering deviation: 4.83..... 42</p>
---	--

<b>B.18.</b>	Yaw rate deviation: 0.067 .....	42
<b>B.19.</b>	Steering deviation: 1.832 .....	43
<b>B.20.</b>	Yaw rate deviation: 0.026 .....	43
<b>B.21.</b>	Steering deviation: 4.055 .....	44
<b>B.22.</b>	Yaw rate deviation: 0.046 .....	44
<b>B.23.</b>	Steering deviation: 2.132 .....	45
<b>B.24.</b>	Yaw rate deviation: 0.025 .....	45
<b>B.25.</b>	Steering deviation: 2.48.....	46
<b>B.26.</b>	Yaw rate deviation: 0.031 .....	46
<b>B.27.</b>	Steering deviation: 26.432 .....	47
<b>B.28.</b>	Yaw rate deviation: 0.133 .....	47
<b>B.29.</b>	Steering deviation: 61.345 .....	48
<b>B.30.</b>	Yaw rate deviation: 0.356 .....	48
<b>B.31.</b>	Steering deviation: 5.037 .....	49
<b>B.32.</b>	Yaw rate deviation: 0.045 .....	49
<b>B.33.</b>	Steering deviation: 8.125 .....	50
<b>B.34.</b>	Yaw rate deviation: 0.101 .....	50
<b>B.35.</b>	Steering deviation: 1.853 .....	51
<b>B.36.</b>	Yaw rate deviation: 0.024 .....	51
<b>B.37.</b>	Steering deviation: 2.955 .....	52
<b>B.38.</b>	Yaw rate deviation: 0.003 .....	52
<b>B.39.</b>	Steering deviation: 2.434 .....	53
<b>B.40.</b>	Yaw rate deviation: 0.026 .....	53
<b>B.41.</b>	Steering deviation: 7.015 .....	54
<b>B.42.</b>	Yaw rate deviation: 0.069 .....	54
<b>B.43.</b>	Steering deviation: 2.997 .....	55
<b>B.44.</b>	Yaw rate deviation: 0.043 .....	55
<b>C.45.</b>	Soft suspension car settings ...	56
<b>C.46.</b>	Hard suspension car settings ..	56



# Chapter 1

## Introduction

Testing new technologies have always played a huge role in any industry. Ever since the eighteenth century, when Nicolas-Joseph Cugnot constructed what is nowadays considered to be the first-ever automobile has automotive industry moved a huge step forwards. But every step on this long journey had to be somehow evaluated. Before huge automobile corporations like Volkswagen or General Motors introduced a new piece of technology to the market it must undergo months or even years of thorough testing. To receive international certificates, it is mandatory to take into consideration every aspect of a new product, and the main focus is safety. They asked participants to evaluate each question with this scale, but with addition of **do not know** option, to cover possible uncertainties amongst less experienced drivers.

From the very start of automotive has been the driving wheel and pedals considered to be the only way of controlling cars. But with this solution is the number of degrees of freedom limited to just two. The car manufacturers have been stuck in one more aspect of controlling the vehicles. Since the first steam-powered car introduced by Cugnot are the steering commands from driver transmitted in a mechanical way in the form of the driving shaft. But with the tremendous growth of modern technologies, it only seems logical to pursue new implementations in this area.

The aircraft industry has proven to be far less conservative when it comes to developing new ways of airplanes and jets. In the 1970s has been tested so called fly-by-wire technology. It replaces manual control of flight with electronic signals. In this area plays a significant role closed feedback loop and its control. This domain is one of the main subjects of studies of the Department of Control Engineering.

In automotive is an alternative to the fly-by-wire concept appropriately called drive-by-wire. This approach seems to be the logical step in the perception of vehicle driving. It could come with several new possibilities that the current **mechanical** approach can not offer. Even though manufacturers come with concept cars that show the possible future of everyday transportation, it has not yet been realised. One of the examples is the Mercedes Avatar concept that comes with an oval-shaped controller instead of a driving wheel. It is a clear sign of driverless future and inevitably the pursuit of drive-by-wire technology.

Drive-by-wire would mean a drastic change in the technical area of automotive, but we can not expect billions of drivers all around the globe to change their perception of driving their cars and to start learning driving from scratch once again. This technology must be widely accepted by the public; therefore, it must feel somewhat familiar even though it means a drastic change of the driving itself. And here could come in handy experience from the aircraft industry. When the fly-by-wire was about to be implemented, it was going to offer better computer controllability. But since there was no mechanical connection between pilot and aircraft control surfaces and actuators, it must have been determined whether or not is the signal rightly interpreted by the computer. In other words, it had to be tested if the plane does what the pilot expects.





# Chapter 2

## Theoretical part

### 2.1 Vehicle handling

Vehicle handling is an interaction between driver, vehicle, and environment. Handling qualities describe the interactions between driver and vehicle. They compose of driving skills and vehicle responses. Driving skills include all necessities to control a car as well as the abilities of the driver to process surrounding perceptions. Bergman divides in his paper [1] vehicle-handling qualities into two parts. One being driver-vehicle handling performance and the other physical and mental skills of the driver.

Term vehicle handling is often understood as vehicle response properties without a driver. By Bergman, the driver's part plays the role of the greatest importance. Each driver has a great ability to perceive surroundings by vision, and thanks to this ability is vehicle handling by big part a visual process. [1]

In most situations, people are unable to use the full potential of handling qualities of their vehicle. Most of the driving experience comes from everyday driving, which does not call for drastic interventions to steering or breaks. On the other hand, when it comes to emergency situations, people tend to have a problem using the full capabilities of their vehicles. The leading example is emergency braking. Most of the people do not use all of the braking power available. For that reason came Mercedes-Benz with a brake assist system (BAS). It was based on their research, which claims that ninety percent of the drivers do not apply enough power on the brake pedal in case of emergency.

### 2.2 Subjective and objective evaluation of vehicle handling

Vehicle handling qualities could be sorted into two main categories: subjective and objective. Steering, throttle, and brake inputs are all important to the final evaluation. Subjective handling evaluation is mostly based on the driver's perceptions of the car; on the other hand, for objective handling evaluation are crucial measurements received from the sensors installed on the vehicle. Fusing these two perspectives could lead to designing a satisfactory vehicle, which could be modeled and predictable [1].

#### 2.2.1 Subjective evaluation

The main criterion in subjective evaluation is the driver's perception. For instance, in Formula 1 vehicle development, it is common to gain feedback from the pilots. When engineers come up with changes to formula dynamics, this modified car is being tested on the circuit. Formula 1 pilots are very experienced drivers and know precisely what changes are desirable. Therefore their feedback comes straight after their test drive and exists as a spoken communication with team engineers. Continuous communication and dialog between the drivers and engineers would probably be the best way in an attempt to achieve desired characteristics. However, this may also lead to a perfect tuning

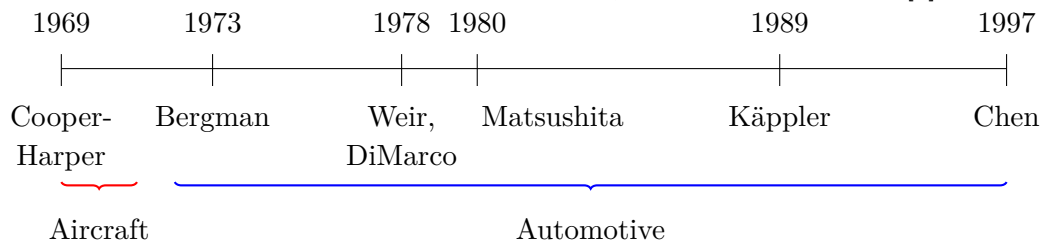
that would actually fit one particular driver. Another disadvantage is gathering the feedback from a large family of daily drivers. For needs of mass testing have been produced several rating scales. Their pros and cons will be discussed in section 2.3.

### 2.2.2 Objective evaluation

Modern science has produced a wide variety of sensors that allow us to monitor practically any aspect in the vehicle dynamics domains. These measurements form complete post-race analysis. Sensor data are valid and well interpretable by experts, which makes them irreplaceable in vehicle development. Still, it is mostly the driver's subjective perception that forms an overall satisfaction with the vehicle use, drive, and ownership.

## 2.3 Rating scales used in automotive

This section will describe evolution in rating scales used to evaluate handling qualities in automotive. It will follow the differences between the scales and the pros and cons of each scale. In the picture 2.1, you can see the timeline of rating scales starting in times of fly-by-wire concept in aircraft and moving towards automotive. [2]

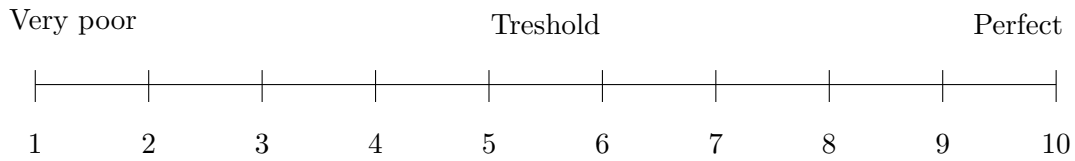


**Figure 2.1.** Rating scales timeline [2]

### 2.3.1 Bergman scale

Bergman believes that this ability is a bit like having an ear for music. It depends a lot on genetics but can be improved by experience. That said, obviously, experienced racing drivers are set to be much more precise in evaluating of vehicle's handling qualities. To express subjective driver perception, a ten-point scale is often used. Number one being least satisfactory and number ten being the most convenient evaluation. Bergman indicates an evaluation of five points to be somewhat of a threshold of acceptability. Any score above five is considered to be an indication of good handling qualities, any score below five of unsatisfactory qualities. [1]

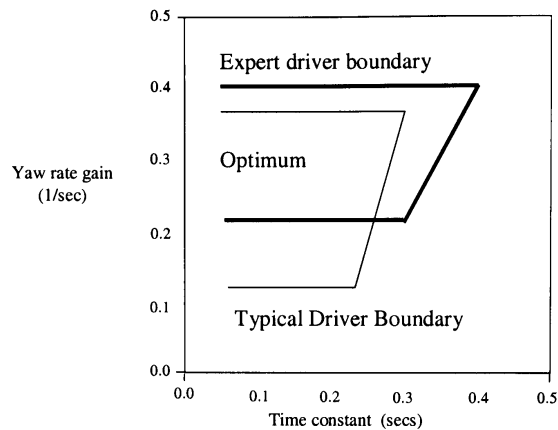
Subjective evaluation should be based mainly on driver's perceptions and not be influenced by any other factors. There are no techniques to determine any bias in subjective evaluation. It is a question of the evaluator's expertise to be able to filter any deviations. It is also vital for the evaluator to be able to recall all of the ride feelings and perceptions when it comes to filling the questionnaire. Bergman also suggests that every driver uses a different weighting system: therefore, you could have two rides and drivers that receive the same signals from their surroundings. But when it comes to evaluation, each of them might have different conclusions. That can be caused by them having different preferences. [1]



**Figure 2.2.** Bergman rating scale [2]

### 2.3.2 Weir and DiMarco rating scale

In their paper [3], Weir and DiMarco use very similar rating scale as Bergman does 2.2. The ten-point scale is used as well, and it is primarily a measure of workload that the driver feels. They gave the drivers an additional option to add written comments in order to gain as much information as possible. It is also pointed out that even if drivers finish the test with satisfactory results, it may not mean that the workload was even. An experienced driver will cope with the test in a professional manner, without unnecessary interventions to steering, and his subjective workload will be marginal. On the other hand, an inexperienced driver may finish in a similar time as a professional, but his steering and pedal usage will lead to a heavy workload. That can be caused by them having different preferences. [1]



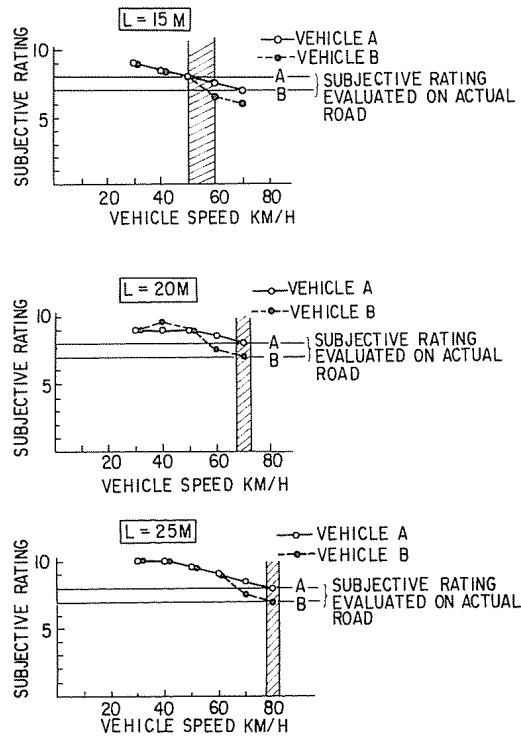
**Figure 2.3.** Satisfactory vehicle response [3]

### 2.3.3 Matsushita and Sano approach

Matsushita and Sano have used a very similar approach to the scale, with ten-point options, but with no word descriptions. Even though drivers were asked to treat the scale as continuous to ensure little deviations could be marked, the answers were closely positioned at the scale. It is probably due to laboratory conditions and good reproducibility. [2]

They have focused on the influence of objective measurements from the ride to the subjective ratings in their paper [4]. It is fair to say that they used an experienced driver to avoid differences in interpretations of the rating scale. The correlation between yaw velocity, lateral acceleration, and driver's rating was found.

The effect of lane-change lengths on speed was also examined. It is expectable that longer the lane-change maneuver, the higher the speed achieved. With every five metres added to the length, the vehicle achieved more kilometers per hour in speed. Starting at fifteen metres and sixty km/h 2.4.



**Figure 2.4.** Subjective rating in various lane change distances [4]

### 2.3.4 Kappler two-level sequential judgement scale

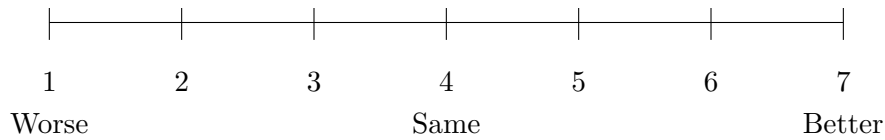
Kappler has used a two-level approach, creating a graphical rating scale. His scale was designed for a double lane change test. The first part of his scale is a question about the amount of steering corrections made to finish the double lane change test. Respondents were given choices about the workload connected with steering, with the three being difficult, medium, and easy. Answer to the first question opened up a way to three additional choices, which were meant to describe the workload in a more detailed way. [5]

Kappler's scale is continuous; therefore it should provide greater sensitivity. The advantage of this scale is its segmentation into smaller sections. This way does the evaluator handle just four points at a time, but their answers belong to a greater nine-point scale. [2]

### 2.3.5 David Chen's rating scale

David Chen, in his thesis [6], discusses the differences between professional drivers and untrained drivers. Professional drivers have clear advantages, as stated in previous chapters, notably in the ability to describe their perceptions more accurately. He objects that even though their qualities of controlling the car may be objectively better, it will may cause a certain bias that leads to different preferences to everyday drivers. In Weir's paper [3], it is pointed out that experienced drivers prefer more responsive vehicles.

In the first place, Chen created a pilot study that contained forty-one questions about car handling, and its abilities. Through testing, he ended up with a seven-point scale for car evaluation. Therefore very similar to scales described before.

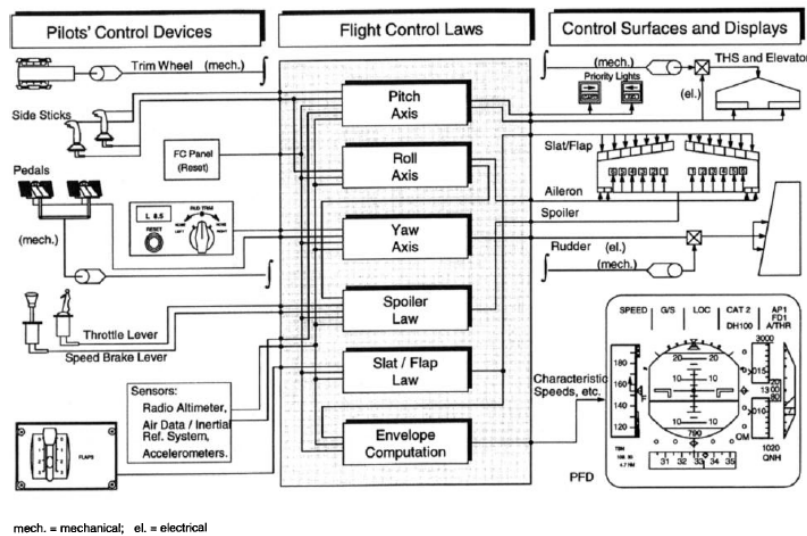


**Figure 2.5.** Chen rating scale [6]

They asked participants to evaluate each question with this scale, but with addition of do not know option, to cover possible uncertainties amongst less experienced drivers.

## 2.4 Fly-by-wire concept

Fly-by-wire is a system that replaces a mechanical connection from pilot inputs to controlling areas of aircraft with an electronic control unit. Why is such a substitution desirable will be discussed in section 2.4.1.



**Figure 2.6.** Signal flow in fly-by-wire aircraft [7]

### 2.4.1 Motivation for fly-by-wire

For an aircraft, having a low take-off and landing speed together with high cruise speed while maintaining an adequate controllability were and still are highly desired features of the good design. In military aviation in particular, these requirements were further extended towards the aircraft maximum agility, thus creating the complex operational boundaries.

With agility is improved maneuverability, which can be crucial for the pilots in action. One way to accomplish this task is to move the center of gravity further back in the plane. This adjustment provides better agility but comes with one big negative. A system like that becomes more unstable than the previous one, making it much harder to control manually. To overcome these contradictions, some sort of control system enhancing the pilot's capabilities and reducing pilot's workload had to be developed. Fly-by-wire systems enable to meet all of those.

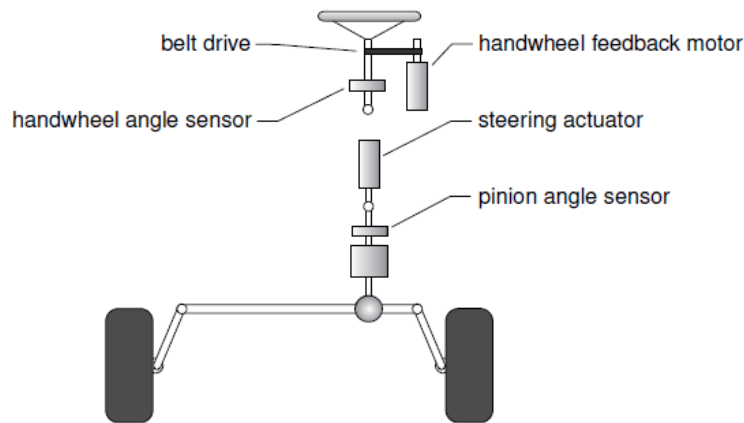


The term drive-by-wire describes the whole concept of the systems, which can be divided into various subsystems. These will be described in the following sections.

### 2.5.1 Steer-by-wire

Steering usually comes in first in the discussion about conversion to the drive-by-wire. The conventional steering system is held back by some limitations in implementing its mechanics and present packaging restrictions and issues. Usually two joints are used to connect the steering wheel to the rack. In Volkswagen cars is the steering wheel even slightly of the centre of the driver, resulting in backaches. The problem of steering wheel placement problem would be resolved by SBW.

The steering wheel could become redundant with drive-by-wire. It could be replaced with many alternatives, such as aircraft sidesticks or other concept controllers. A new technology of four-wheel driving can offer the option to do so. Car manufacturers are conservative about the driving system, but it would come with many improvements. If we stick to today's state and implement the SBW system, we lack feedback from the wheels that the mechanical connection offered us. For that reason is added to the steering wheel a feedback motor, similar to one existing in our simulator wheel 4.3.



**Figure 2.7.** Steer-by-wire scheme [8]

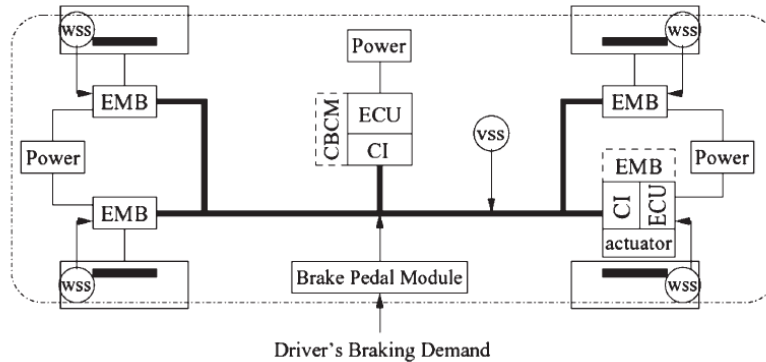
As of today, the vehicle's handling dynamics are influenced by the mechanical build of the steering. That puts limitations on adjusting this steering and can cost a lot of financial resources during the development. With the addition of the control, all this can be done on the go. From the perspective of the driver can the whole perception of steering fundamentally change, even though just one constant in the code has been changed. [8]

### 2.5.2 Brake-by-wire

Brake-by-wire replaces hydraulics by electromechanical actuators. It can enhance safety, thanks to having a central controller, which can have a significant effect in emergency situations. It can affect the disk brakes through the actuators with more power than most drivers, making it much safer. Some braking systems are already installed in modern cars, amplifying driver's input, but brake-by-wire could have implemented complex control systems.

BBW also removes heavy mechanical parts, making the vehicle lighter, thus more power- and fuel-efficient. The brake motors installed to wheels can have instant reaction and impact to the braking, making the braking more responsive. Additional systems,

like electronic stability program and others, can be included in a straightforward way into the processor. BBW has also environmental impact, thanks to excluding hydraulics and prevent any leaks. [9]



**Figure 2.8.** Brake-by-wire scheme [9]

- ECU – Electric control unit
- EMB – electromechanical breaks
- CBCM – Brake control and management module
- CI – Communication interface
- WSS – Wheel speed sensors
- VSS – Vehicle speed sensors,

### ■ 2.5.3 Throttle-by-wire

Throttle-by-wire is a technology that is already widely used in the vehicle industry. It uses the throttle pedal position sensor, and based on the data harvested from it, the controller of the engine system can work precisely. Thanks to the ability to model such a system and abilities of its controlling, it is possible to automate the whole process and manage improved fuel economy. With throttle-by-wire also comes great safety advantage. When the mechanical connections are omitted, it is preventing the throttle pedal from getting stuck. [10]

Car manufacturers can model torque management at our vehicles, resulting in substantial options when selecting our driving style. In modern vehicles with automatic gearbox is present interface with a selection of driving modes, such as ECO, comfort, and sport. Connection of controlling torque, gearbox speed, and many other systems in modern cars allows us to adjust vehicle dynamics to fit our real-time needs.



# Chapter 3

## Methodology

With the information gained while studying rating scales 2.3, has been developed a compact methodology to test handling qualities. In collaboration with my supervisor Ing. Petr Liškář, we have created a questionnaire with the aim of finding correlations between objective measured telemetry data and subjective evaluations.

This questionnaire is inspired by original Cooper-Harper scale 3.1 used in the aircraft industry and offers many advantages over the rating scales used in automotive. Firstly, the driver is answering questions, rather than choosing a number in a given range. The questions appear on the basis of the previous answer, therefore the respondent does not see the whole questionnaire in advance. That should ensure the more precise final value on the rating scale.

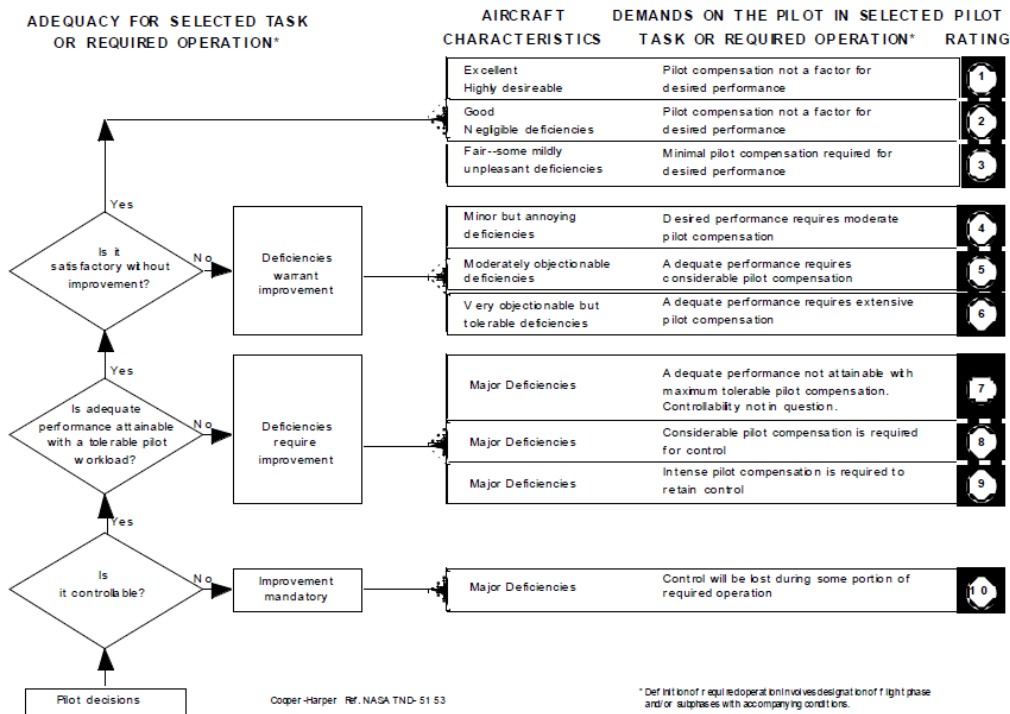


Figure 3.1. Original Cooper-Harper rating scale [11]

The final form of the modified Cooper-Harper scale is shown in section 3.1. It leads to seven final values, which is different to the original ten-point scale.

### 3.1 Cooper-Harper

### 3.1.1 Cooper-Harper diagram

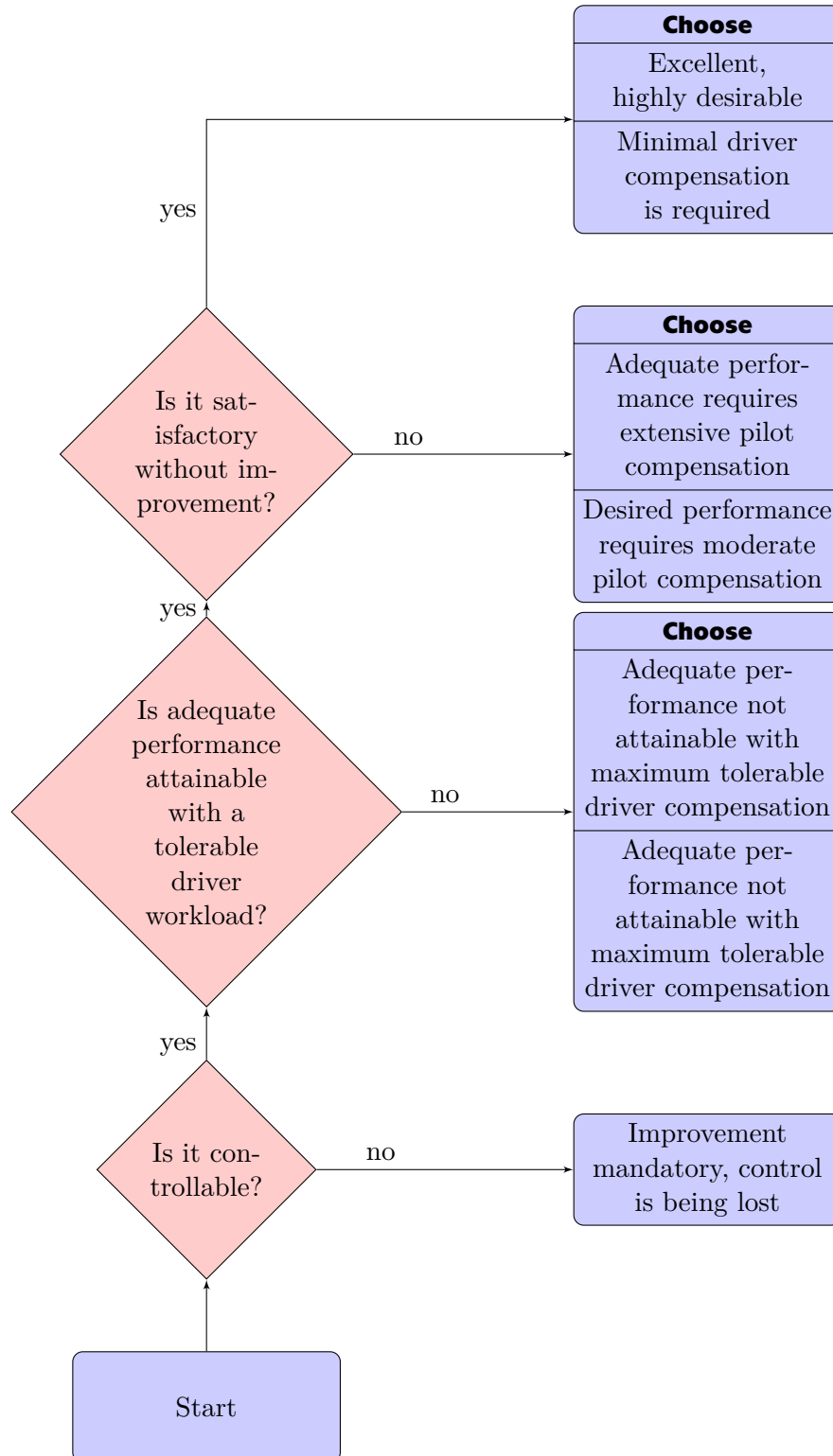


Figure 3.2. Cooper-Harper diagram

### 3.1.2 Czech version of Cooper-Harper diagram

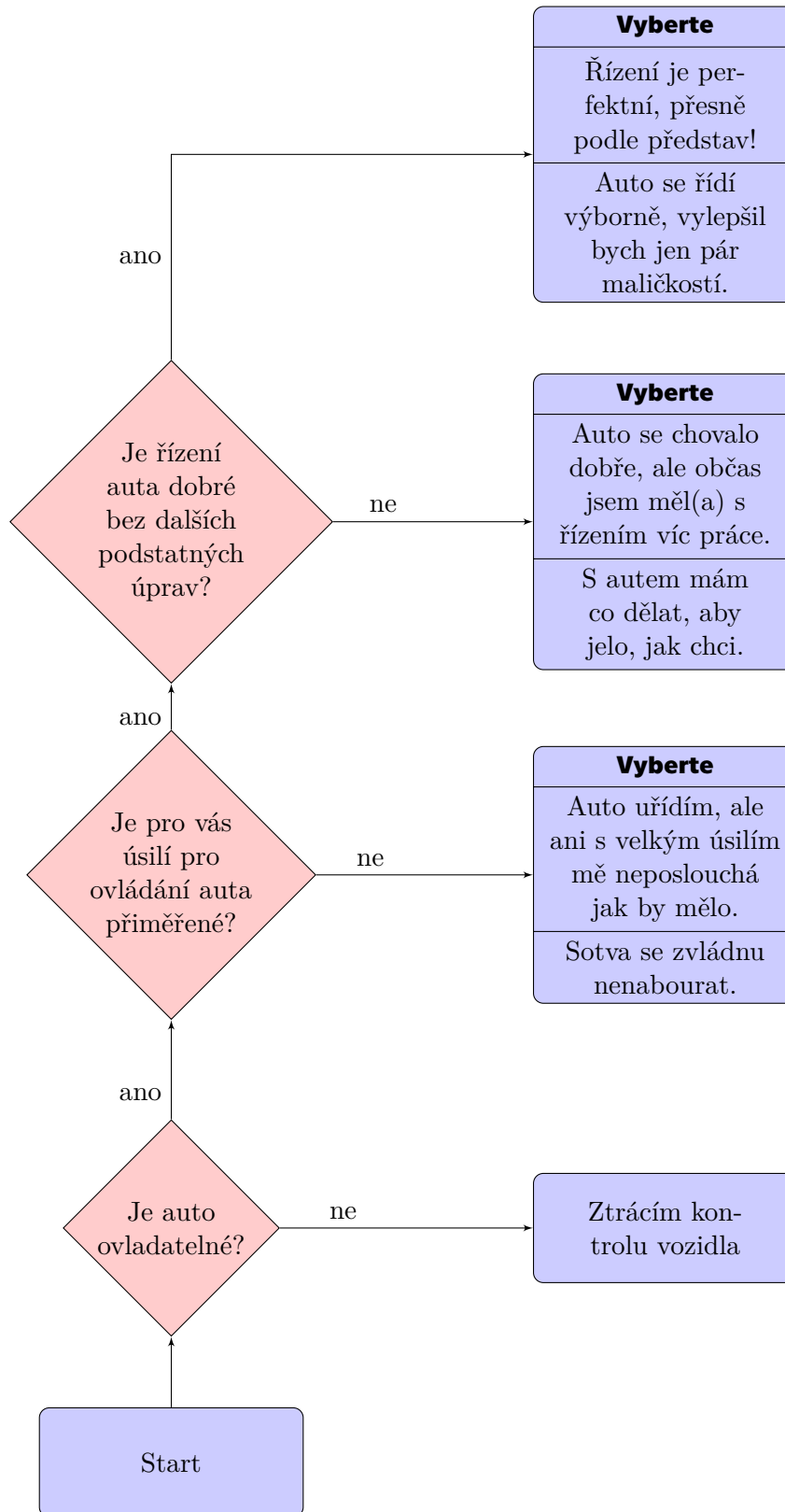


Figure 3.3. Czech version of Cooper-Harper diagram

## 3.2 Questionnaire

We also asked several questions in addition to the information gained by the modified Cooper-Harper scale 3.1. These questions should help us to understand the driver's abilities and possible bias towards the final evaluation. The questions are listed below

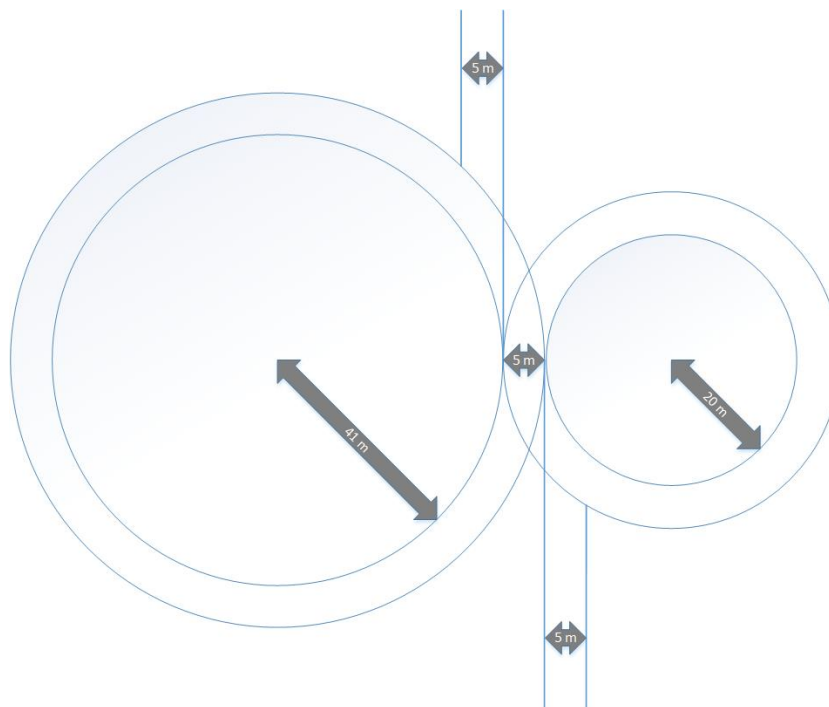
- What is your age?
- What is your gender?
- What category of the driving license do you possess?
- For what period of time do you possess it?
- How often do you drive?
- How many kilometers a year do you cover?
- Do you play simulator games?

## 3.3 LFS environment

In collaboration with my supervisor, we prepared several maneuvers which should test dynamics and abilities of the car and additional control systems.

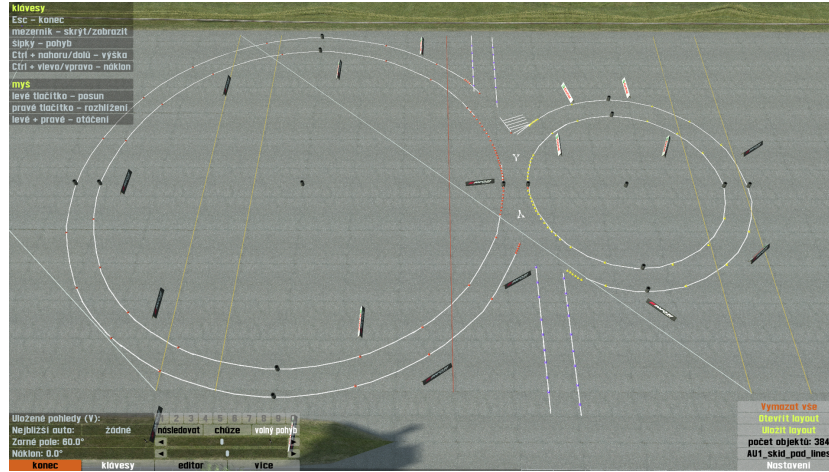
### 3.3.1 Skidpad

The first of the tests is a well-known skidpad. Usual skidpad used for example in Formula Student races consist of two circular tracks with a defined but same radius. It is mostly used to measure lateral acceleration. Our testing track is a bit modified. We have decided to go with two different circles, the bigger one having an inner radius of 41 metres and smaller with 20 metres. It makes the change of tracks in the middle more demanding and increases the driver's workload. Not only must the driver adjust the steering angle but quite significantly the throttle pedal to manage to stay in the circular area.



**Figure 3.4.** Skidpad layout

I recreated this layout in the simulator's editor, as seen on 3.5. We have decided to add commercial banners which are present at the Formula1 circuits to have the additional feeling of speed and your surrounding. Especially on the static simulator having these banners absent made a huge difference in reception of the vehicle's velocity.



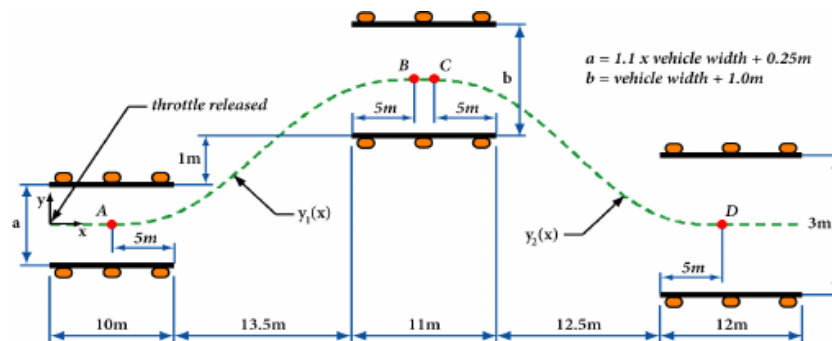
**Figure 3.5.** Skidpad layout in simulator

### 3.3.2 Double-lane change

Double-lane change is a frequently used test in automotive, and it is defined by International Organization for Standardization [12]. It is used to evaluate the handling performance of a vehicle and is a key part of its development.

It consists of five main sections:

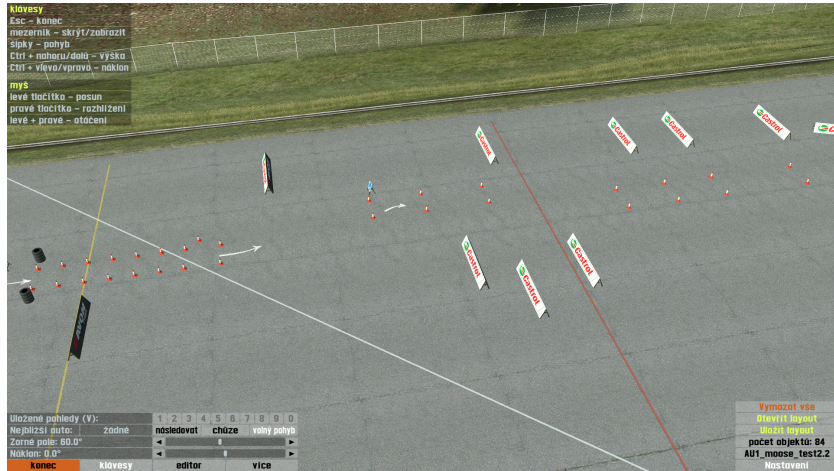
- First section: – Ten meters long straight bordered by the cones. It has a width of  $w = 1,1 \text{ vehiclewidth} + 0,25 \text{ m}$ .
- Second section: – Thirteen and a half metres long gap between two adjacent lanes. Those two lane have one-metre gap in-between.
- Third section: – The second lane which is eleven metres long and has a given width of  $w = \text{vehiclewidth} + 1 \text{ m}$ .
- Fourth section: – Twelve and a half metres long gap between two lanes.
- Fifth section – The final section which has a fixed width of three metres and marks a return into the first lane.



**Figure 3.6.** Double-lane change maneuver scheme [13]

In the real world, sports cars like Porsche 911 are capable of hitting maximum speeds of around ninety kilometres per hour, which are arguably top speeds achievable. Family

SUV's are typically struggling to do well in this test. There have even been several incidents of turning these unstable cars on the roof.



**Figure 3.7.** Double-lane change maneuver in simulator

The recreation of this maneuver in simulation 3.7 is built on parameters specified in ISO 3888 standard [12]. Commercial banners have been added for better speed perception.

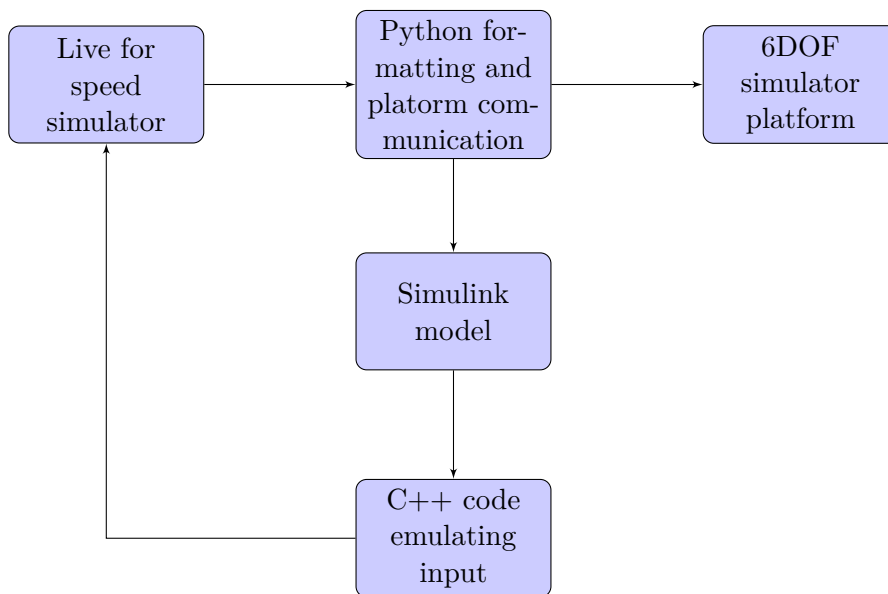
# Chapter 4

## Framework

My thanks belong to Tomáš Twardzik and Adam Škuta, which I joined to collaborate on a summer project. This framework was created in collaboration with them. Thanks to almost endless possibilities of Live for speed simulator, have we been able to put together a functional set of programs for future use.

From the beginning, the main purpose of this framework was to read as much real-time signals from Live for speed simulator and connect them to MATLAB Simulink program for possible additions of control systems.

### 4.1 Framework outline



**Figure 4.1.** Framework outline

The principle of this framework is demonstrated in diagram 4.1. Live for speed simulator has built-in outsim mode that sends UDP packets with signals about the car dynamics. These packets are handled by Python executable file, formatted, and sorted. From this point in the chain, we have real-time information about the situation inside the simulator.

After processing needed signals, the Python file sends them to the more convenient interface known to students and engineers Simulink. The model with all the accessible signals is prepared in Simulink and ready for future control systems such as cruise control to be added.

Not only does the Python file processes all the signals and forwards them to Simulink, but it also plays a great role in our prepared tests. From the data about accelerations from the simulator are we able to calculate signals for our 6DOF simulator platform.

These signals need to have limits so that we don't destroy the simulator or its surrounding in any way or cause any harm to its users. The connection with the 6DOF platform will be described more thoroughly in section 4.2.

If we want to complete the loop back to the LFS, we need to somehow send the control signals. But imagine having some control system added to the Simulink model. It is clear that at that time, we can not let LFS process signals directly from physical wheel and pedals since these would differ from those coming out of the control system. Therefore these signals have to go through some kind of emulator, which leads us to C++ program.

For this purpose is used Vjoy [14], which is an open-source configurable virtual joystick. From the Simulink model are the final signals send by UDP protocol straight to the C++ program. This program takes care of the emulating of the wheel wheel and pedals so that LFS does not see any difference.

## 4.2 Python

This section describes the functionalities of the Python file and its position in the framework as a whole.

### 4.2.1 Connection from LFS to Python

At the beginning of the simulator session, LFS starts sending UDP packets at the 100 Hz rate (can be limited).

### 4.2.2 .Csv possibilities

In order to have full control over signals from all rides has been added the option to save them to comma-separated value format, known as .csv. It is fair to say that this was not possible when we started working on this project. Number of real-time signals was pretty limited by the Live for speed simulator and producing full-ride analysis was done in a rather complicated manner.

In the first place, recordings of the rides had to be manually enabled. Next step was to play the recording manually and with built-in tools in the simulator could be produced a special formatted .raf file. This .raf file contains info about one lap at maximum and can be derived from just native circuits added by developers.

To receive somewhat usable format were used third-party software created in collaboration with creators of Live for speed. It became quite clear that this long process of creating a simple comma-separated value file does not fully meet our expectations of working with recorded data.

Thanks to communication with one of the developers of Live for speed, it was possible to increase the number of real-time signals by a great margin. All the available signals are listed in section 4.2.6.

The remaining part was added to the Python part of our framework. At the start of each run is created comma-separated value file with the name of your choice. The header consists of the names of recorded signals. Then during testing and driving is at the rate of maximum hundred times a second added one line of values.

### 4.2.3 Controller functions

The library `controller_functions.py` contains functions used to work with our Thrustmaster steering wheels with pedals 4.3 and vJoy emulator [14]. The `pygame` library is imported into this file.



The file `controller_functions.py` includes following functions:

- `joystick_info(controller)` – prints all available information about the controller
- `get_device_ids(joysticks, wheel_id, emulator_id)` – sets id's of racing wheel and emulator
- `print_emulator_values(packet)` – prints values of signals sent so Simulink

#### ■ 4.2.4 Platform functions

The functions that control the communication with the 6DOF platform have been already written by Tomáš Twardzik and Adam Škuta, when I joined them at the summer project. After that, Tomáš and I made just a few corrections to the limits of forces and accelerations at the platform to improve the overall performance. Once again, I would like to thank Tomáš for a great cooperation and original ideas.

Functions in the `platform_functions.py` file:

- `convert_packet(packet)` – converts radian values to degrees
- `factor_input(factor, packet)` – multiplies values in packet sent to platform by constant factor ( $<1$ ) to ensure safety
- `limit_input(packet)` – contains functions limiting accelerations, angular velocities and orientation
- `handle_packet(packet)` – uses all three function above to fully prepare the packet for platform

#### ■ 4.2.5 Transform functions

The file `transform_functions.py` contains transformations necessary to reproduce game signals into a signal that can be sent into the platform. The main function transforms global accelerations connected with a fixed point on a virtual map to the accelerations on the 6DOF platform. It contains basic multiplication by a general rotation matrix. Again, great thanks for the work at these functions goes to Tomáš Twardzik and Adam Škuta.

#### ■ 4.2.6 Available real-time signals

LFS allows us to read following real-time signals:

- Time [ms]
- Angular velocities [rad/s]
- Roll, pitch, yaw [rad]
- Accelerations – (x,y,z directions) [ $\text{m/s}^2$ ]
- Velocities – (x,y,z directions) [m/s]
- Position towards set point in simulator – (x,y,z)
- Throttle – (in range between 0 and 1)
- Brake – (in range between 0 and 1)
- Input steer – (in radians)
- Clutch – (in range between 0 and 1)
- Handbrake

In addition does Live for speed offer signals for each individual wheel. It enables future detailed analysis of ride and makes it easier to recognise little flaws in driver decision making. Those are as follows:

- Suspension deflection – Compression from the unloaded damper

- Steer
- Forces – in x and y axes
- Vertical load – Perpendicular to surface
- Angular velocities
- Lean relative to the road
- Air temperature
- Slip fraction
- Slip ratio
- Tangent of slip angle

### 4.3 Thrustmaster wheel and pedals

Thrustmaster T300RS racing wheel is used for the simulator driving. It offers great comfort and adjustability concerning the force of the feedback given by the coil, rotation angle, and gain settings, as seen on 4.2. That meets our expectation of precisely setting the car feeling in the way we expect.

We wanted to achieve similarity with an everyday driving car and distinguish the feeling at the 6DOF platform from a racing car. At the typical racing car is a wheel rotation angle set at about  $270^\circ$ . The driver of that car is then able to control the car in a more sensitive way and does not have to change positions of his hands. We set the rotation angle at  $720^\circ$ , which reflects the steering of an everyday vehicle.

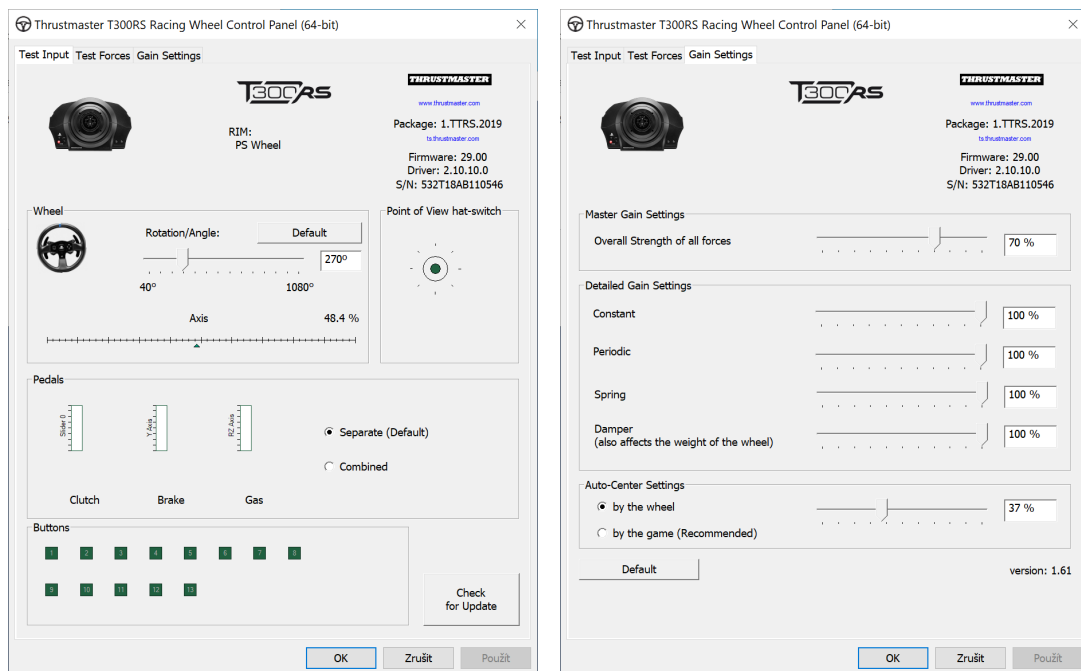


Figure 4.2. Thrustmaster control panel

#### 4.3.1 6DOF platform

Great thanks belong to doc. Ing. Pavel Pačes, Ph.D. from our faculty, who provided us with a great piece of technology, such as this 6DOF platform 4.3. Mr. Pačes was very helpful with our code and answered all our questions about the platform.



**Figure 4.3.** 6DOF Platform

The whole platform weighs about 700 kilograms and can carry up to 2000 kilograms. The movement is assured by six electric motors, putting together up to 17 kW. The communication with the platform is provided by a PC with 16 core Intel Xeon and very powerful Nvidia GTX 1080 Ti graphics card.



**Figure 4.4.** 6DOF Platform in motion

## 4.4 Matlab/Simulink

The Simulink model is prepared for the addition of the control algorithms, such as cruise control, yaw damper, and such. It saves all the signals from the simulator into the time array called `out.lfs_data`.

In the picture 4.1 is a position of this Simulink model in the whole framework. It receives formatted data from the Python file through the block UDP\_receiver. After processing all the signals inside this model, these are resend to the C++ file, which then emulates the steering wheel. The communication is described in section 4.4.1.

#### 4.4.1 UDP receive/send blocks

UDP receive and send blocks take of the communication with the other files in the framework. UDP receiver gathers all the signals transmitted from the Python file. Following parameters must be specified:

- Local IP port – specifies the port at which it receives data
- Remote IP address – can be set to a loopback address, if the python file is on the same computer
- Receive buffer size – expected data block size in bytes
- Maximum length for the message
- Sample time

UDP sender takes all the modified signals from the model and sends them to the C++ file. Those signals serve to emulate the steering wheel and pedals, so it send steering, braking, and throttle. Since the automatic gearbox is set in LFS simulator, shifting signals are omitted. This block contains these parameters:

- Remote address – IP address of the receiving computer with C++ file
- Remote port – specifies the port to which it sends data
- Byte order – specifies little/big endian format
- UDP packet size

## 4.5 Live for speed options

This section shows the settings, that can be adjusted for each car in Live for speed:

- Brake balance and power
- Ride height reduction
- Suspension stiffness
- Damping
- Anti-roll
- Maximum steering lock
- Toe in at the front and rear wheels
- Camber adjust
- Tyre pressure



Figure 4.5. Example of car adjustability

# Chapter 5

## Tests execution

### 5.1 Testing process

Each test started with the volunteer filling the first part of the questionnaire. That consists of questions about age, gender, etc. and is described in chapter 3. We then both took a seat on the 6DOF platform. Volunteer test driver was then introduced to the environment of Live for speed simulator and the skidpad track 3.3.1. Each driver had a few minutes to get used to the simulator, but without the platform running, so that the first impression of the whole platform would not be overwhelming.

When the driver got acquainted with the Live for speed simulator, I turned on the platform. The next ride's signals have been recorded, and our driver then filled the modified Cooper-Harper questionnaire. In the meantime, the setting of the car has been switched, and the driver repeated the maneuver. Once again, he answered the Cooper-Harper and the test drive was finished.

There was one final part of the test, which we called the passenger test. The passenger test was composed of a prerecorded ride, which was then played back on the monitors with the signals sent to the platform. The driver was asked to let go of the steering wheel and experience the ride from the passenger point of view. The driver then filed a slightly modified Cooper-Harper 5.1 rating about the feelings from it.

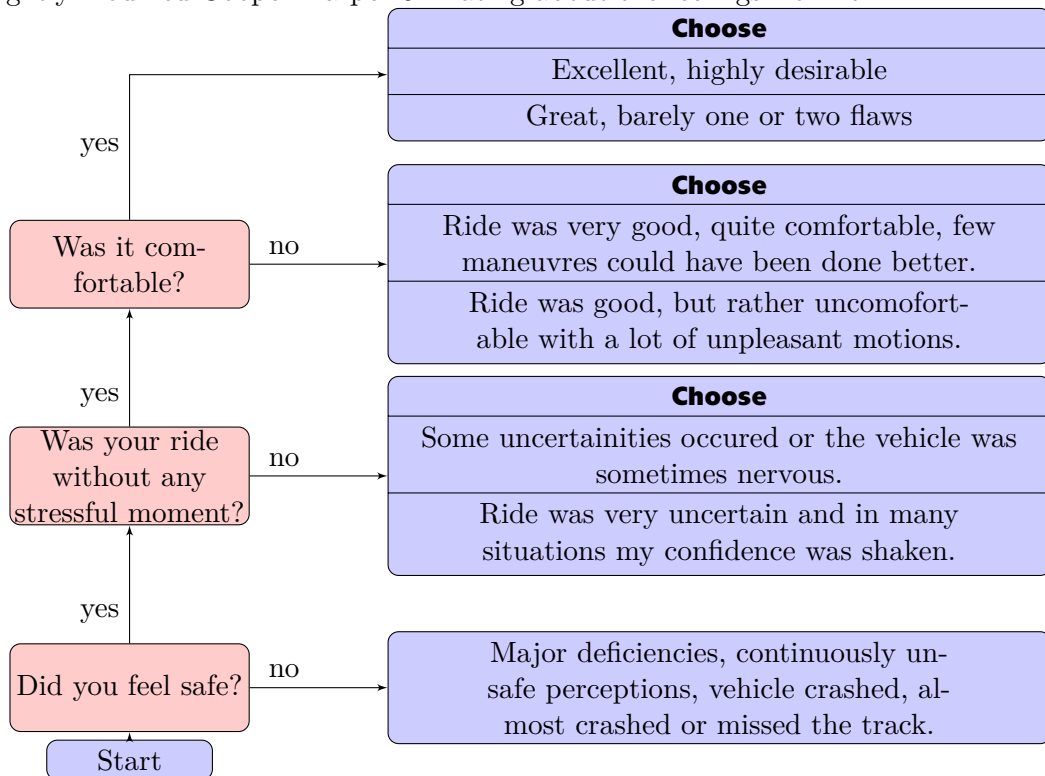


Figure 5.1. Passenger version of Cooper-Harper diagram

## 5.2 Data collection

Actual testing of riders on simulator platform at school has been unfortunately affected by the coronavirus outbreak at the time of preparation of this thesis. All the government restrictions stopped us from testing volunteers at the larger scale. Testing before the restrictions due to coronavirus has also been impossible, because the 6DOF platform has not been available at school.

I have managed to take several tests despite all the inconveniences. Even though the statistical sample may not be as big as we wanted, I believe it can still reflect the correlations between telemetry signals and subjective ratings.

Age	Gender	Driving Licence (Years)	How often do you drive?	Km per year driven	Do you play simulator games?	Ride logs
22	Male	B(4)	Monthly	800	No	B.1, B.2
22	Male	B (4)	Monthly	3000	No	B.3, B.4
22	Male	B (4)	Monthly	2000	Yes	B.5, B.6
22	Female	B (4)	Monthly	1000	No	B.7, B.8
25	Male	B (6)	Monthly	150	No	B.9, B.10, B.11, B.12
29	Male	B (11)	Weekly	10000	No	B.15, B.16, B.17, B.18
23	Male	B (3)	Never	1	No	B.19, B.20, B.21, B.22
37	Male	B (20)	Daily	30000	No	B.23, B.24, B.25, B.26
30	Male	B (10)	Daily	35000	No	B.27, B.28, B.29, B.30
38	Male	B (23)	Daily	20000	No	B.31, B.32, B.33, B.34
22	Male	B (4)	Weekly	2000	Yes	B.35, B.36
21	Female	B (4)	4 times a week	20000	No	B.37, B.38, B.39, B.40
37	Male	B (19)	Weekly	40000	No	B.41, B.42, B.43, B.44

**Table 5.1.** Questionnaire answers

## 5.3 Pearson correlation coefficient

I will be using a Pearson correlation coefficient to review the harvested data. It should help in revealing whether any correlations between the signals appear. The Pearson correlation coefficient (PCC) is a number in the interval of  $\langle -1, 1 \rangle$ , and it measures linear correlation between two random variables in statistics. [15]

$$\text{PCC} = \rho(X, Y) = \frac{\text{cov}(X, Y)}{\sigma_X \sigma_Y} \quad (1)$$

$$\text{cov}(X, Y) = E(XY) - E(X)E(Y) \quad (2)$$

In the equation (2) is  $E(X)$  an expected value, defined as :

$$E(U) = \sum_{u \in O_U} u \cdot p_U(u) \quad (3)$$

, where  $O_U$  is the range of values and  $p_U$  being the probabilities of occurrence. In equation's (1) denominator appears  $\sigma$ , which is a sign of standard deviation. It is defined as:

$$\sigma_X = \sqrt{D(X)} \quad (4)$$

$$D(X) = E(X^2) - (E(X))^2 \quad (5)$$

Pearson correlation coefficient applied to a sample can be formulated as:

$$r_{xy} = \frac{\sum_{i=1}^n (x_i - \bar{x})(y_i - \bar{y})}{\sqrt{\sum_{i=1}^n (x_i - \bar{x})^2} \sqrt{\sum_{i=1}^n (y_i - \bar{y})^2}} \quad (6)$$

- $n$  is the sample size
- $\bar{x}$  is the sample mean
- $x_i, y_i$  are the sample points

With the Pearson correlation coefficient reaching to a positive one, we are talking about positive linear correlation; analogically, when PCC gets closer to minus one, it is considered to be a negative linear correlation. PCC equaling to zero is a sign of an absence of any correlation between two variables.

## 5.4 Evaluation

Because of the coronavirus limitation, we reduced the testing just for the skidpad track 3.3.1. Selected signals, like steering and yaw rate, have been added to the appendix B. I have used the statistical method of correlation coefficient and written down correlations of selected variables to the table 5.2.

Correlation coeff. r	AYRD	Age	Kilometers	Avg Speed	Rating
ASWD	0,96	0,02	0,24	0,43	-0,71
AYRD	-	0,05	0,19	0,33	-0,70
Age	-	-	0,74	0,18	-0,02
Kilometers	-	-	-	0,22	-0,21
Avg Speed	-	-	-	-	-0,32

**Table 5.2.** Pearson correlation table

- ASWD - Average steering wheel deviation [ $^{\circ}$ ]
- AYRD - Average yaw rate deviation [rad/s]
- Kilometers - refers to driver's kilometers per year driven

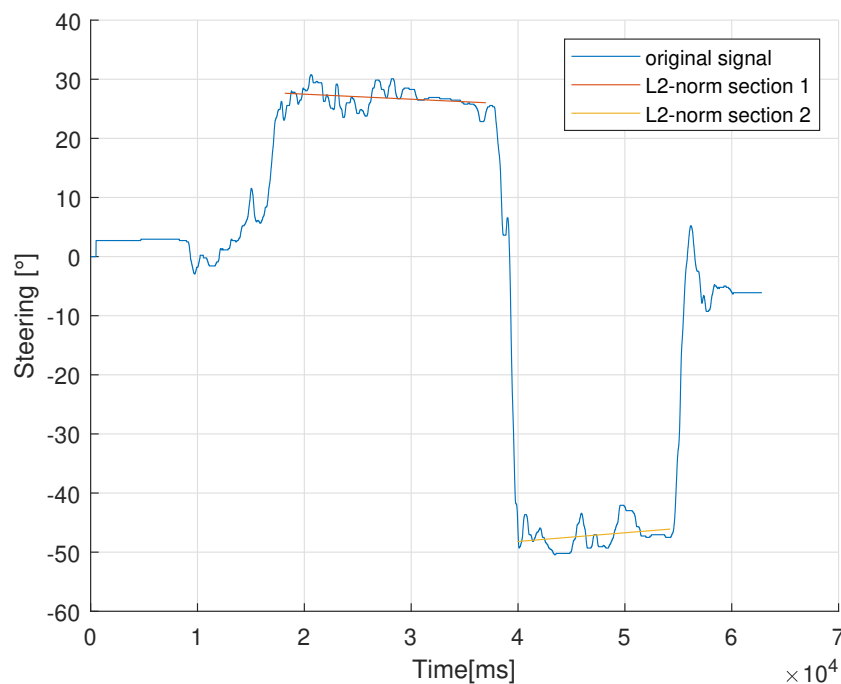
ASWD and AYRD have been calculated from the signals seen in the appendix B. I have selected the two sections in the signals, representing the two circles on the



skidpad. I have used the least-squares at each section and fitted each section with a linear function. After that has been calculated, an average deviation from those fits.

The highest correlation coefficient is between average steering wheel deviation and average yaw rate deviation : 0.96. The connection between those two signals has been expected, so it just confirms the correctness of our hypothesis of using the Pearson correlation coefficient.

The most promising result appears to be in the correlation between ASWD and rating and AYRD and rating ( $-0.71$  and  $-0.70$ , respectively). These numbers are signs of a strong negative correlation. It means that if the driver had a problem keeping a steady steering wheel angle when performing a turning maneuver at one of the circles, he was more likely to rate his drive with a lower score. Our premise can be shown at the ride log from a reference ride 5.2, where we tried to demonstrate a smooth ride through the skidpad. You can see that the steering angle is almost steady in both sections.



**Figure 5.2.** Reference ride - steering

The other interesting correlation is between the average speed of the maneuver and steering wheel deviation. That means that there is a direct link between speed and the ability of the driver to maintain a steady turn. That denotes that some of the drivers were testing the vehicle to its handling limits.

We have also tested two different settings of the same car. The differences can be seen in the appendix C. Both cars received very similar ratings of 4.92 for the softer suspension car and 5 for the harder suspension car. We also expect the drivers to achieve higher average speed in the harder suspension car, which is, in our opinion, generally better to handle. This premise has not been confirmed though, while both cars achieved almost identical average speeds. This can have several explanations, though. In the given conditions, we collected a smaller statistical sample than we wanted, but it still reflects some trends. The other reason may be the sequence of the cars for the driver. Each driver had just a few minutes to get used to the feeling of our simulator and its surroundings so that each additional ride could mean a better understanding of the vehicle's behaviour. The hard suspension car has been usually the second the volunteers drove. In my opinion, they adjusted their speed in their second rides to drive through



the skidpad in a calm way. So, in the end, the same average speeds of both car settings may actually be a sign of better handling qualities of the one with a harder suspension. Some of the drivers confirmed during the conversation after testing that they spotted a difference in the handling of the car between their two runs.

#### ■ 5.4.1 Passenger testing

We also included the second part of our testing, which we called a passenger test. That included prerecorded reference ride 5.2, which ensured the same forces perceived by each driver. The outcome of the passenger questionnaire is that all the results are in the range of five to seven. That means that the drivers have a tendency to rate the same perceptions similarly.

## Chapter 6

### Conclusions

The primary objective of this thesis was to prepare a methodology base enabling objective evaluation of a passenger car control system based on subjective drivers' inputs and impressions. That contains studying the rating scales used in the past and coming up with the one, that would meet our expectations.

The motivation for doing so is the vision of a drive-by-wire concept described in this thesis. The methodology introduced in this thesis could help in testing the handling qualities of the vehicles when transforming to the drive-by-wire system.


The crucial part of this thesis is the preparation of conditions for the testing of the public. The basis of our methodology lies in a software framework that connects an existing Live for speed simulator with a 6DOF platform at our university. It allows us to read a wide range of telemetry signals and evaluate them with respect to subjective ratings. The framework allows us to simulate real-world car's perceptions on a 6DOF platform.

Even though the feeling on the platform appears to be very realistic, there are several modifications that could make the impression of the rides more lifelike. From the conversations with the volunteers that participated in testing, results in one clear modification requirement to the physical state of the simulator. That could be covering the view around the monitors by a blanket or some cardboards. Our platform substitutes accelerations by tilting the seats and using gravitation to achieve the same effect. That could be better accepted by the drivers if they did not see the surroundings of the simulator. Mainly the braking feels rather unnatural with the reference points on the wall behind the monitors. There is also a loud sound coming from a cooler of the power source. This could be resolved in the future by isolating the power source or using headphones for the driver.

We have found a correlation between the deviation from the optimal steering angle and subjective rating. The same correlation has been found between the yaw rate and the subjective rating and I believe that this area could be a target of future research and could help in developing a drive-by-wire system, that would be well accepted by end-users.

I have already stated a few future improvements in an area of the 6DOF platform. But there could be several improvements in the testing part as well. The main one would definitely be a bigger statistical sample, which could not be unfortunately done, given the state of the world and the coronavirus limitations. That would provide more reliable results and find correlation in the areas, which could not be verified due to a lack of diversity of samples, such as gender, age, and more. The addition of a professional driver to the testing sample may be very interesting to analyze and could provide new engaging results.

There is also an exciting area that could enrich the results of future research, and that is measuring biometrics. The data about the heart rate and blood pressure could potentially help us better understand the workload, that each individual driver feels while performing our tests.



There would be done some changes if it wasn't for the pandemic state. We would definitely test a more diverse sample of drivers to explore other connections with the information that could not be checked with our sample. A higher number of people would be tested for better accuracy of the results, and they would probably be given more precise task formulation, such as trying to perform the smoothest turn possible. That could be complicated by using cruise control and setting the higher speed for each try. Finally, we would give drivers more time on the platform, so that we could eliminate the first impressions from the whole experience.

## References

- [1] Walter Bergman. *Measurement and Subjective Evaluation of Vehicle Handling*. In: *National Automobile Engineering Meeting*. SAE International, 1973.  
<https://doi.org/10.4271/730492>.
- [2] Howard Alan Simon Ash. *Correlation of subjective and objective handling of vehicle behaviour*. 2002.
- [3] David H. Weir, and Richard J. DiMarco. *Correlation and Evaluation of Driver/Vehicle Directional Handling Data*. In: *1978 Automotive Engineering Congress and Exposition*. SAE International, 1978.  
<https://doi.org/10.4271/780010>.
- [4] Akifumi Matsushita, Katsuji Takanami, Nobuyoshi Takeda, and Masaru Takahashi. *Subjective Evaluation and Vehicle Behavior in Lane-Change Maneuvers*. In: 1980. -.
- [5] WD K ppler, and H Godthelp. Design and Use of the Two-Level Sequential Judgment Rating Scale in the Identification of Vehicle Handling Criteria: I. Instrumented Car Experiments on Straight Lane Driving. *Forschungsinstitut flir Anthropotechnik. FATBericht Nr. 79.*. 1989,
- [6] David E. Chen. *Subjective and objective vehicle handling behaviour*. In: 1997.
- [7] Roger W. Pratt. *Flight Control Systems*. The Institution of Engineering and Technology, Michael Faraday House, Six Hills Way, Stevenage SG1 2AY, UK: IET, 2000-1-1. ISBN 9780852967669.
- [8] Paul Yih. Steer-by-wire: Implications for vehicle handling and safety.. 2005,
- [9] W. Xiang, P. C. Richardson, C. Zhao, and S. Mohammad. Automobile Brake-by-Wire Control System Design and Analysis. *IEEE Transactions on Vehicular Technology*. 2008, 57 (1), 138-145.
- [10] Pratik Parsania, and Ketan Saradava. *Drive-By-Wire Systems In Automobiles*. In: 2012.
- [11] JR. R. HARPER, and G. COOPER. *Wright Brothers Lectureship in Aeronautics - Handling qualities and pilot evaluation*. In: *Aircraft Design Systems and Operations Meeting*. Reston, Virigina: American Institute of Aeronautics and Astronautics, 1984-10-31. -.  
<http://arc.aiaa.org/doi/10.2514/6.1984-2442>.
- [12] *ISO 3888-2 Passenger cars - Test track for a severe lane-change manoeuvre*. 2nd ed edition. Geneva: ISO copyright office, c2011.
- [13] Stavros Angelis, Matthias Tidlund, Alexandros Leledakis, Mathias Lidberg, Mikael Nybacka, and Diomidis Katzourakis. *Optimal Steering for Double-Lane Change Entry Speed Maximization*. In: 2014.
- [14] *Vjoy - Virtual joystick device*.  
<https://sourceforge.net/projects/vjoystick/>.

- 
- [15] Mirko Navara. *Pravděpodobnost a matematická statistika*. Vyd. 1 edition. Praha: Nakladatelství ČVUT, 2007. ISBN 978-80-01-03795-9.





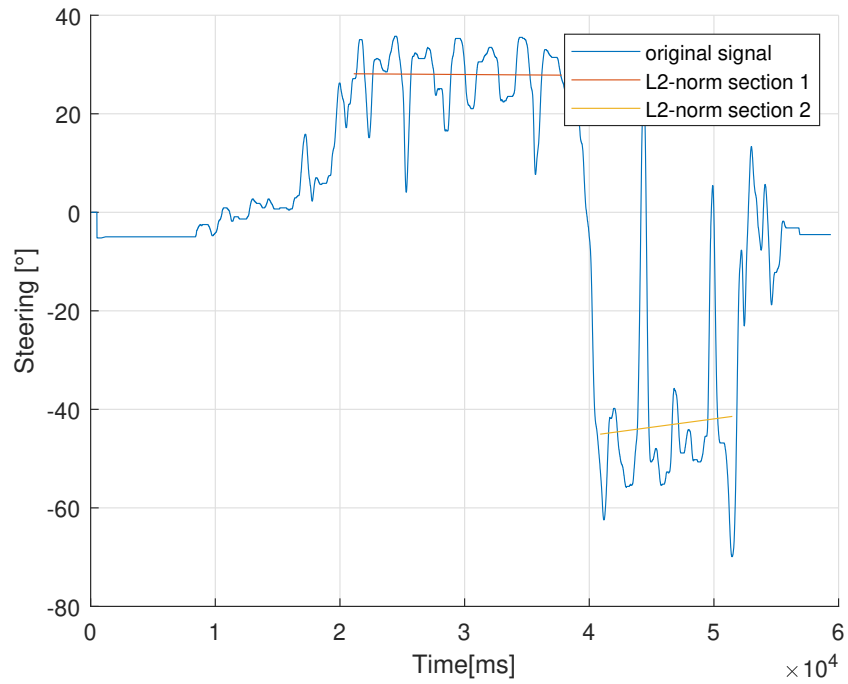
# Appendix A

## Glossary

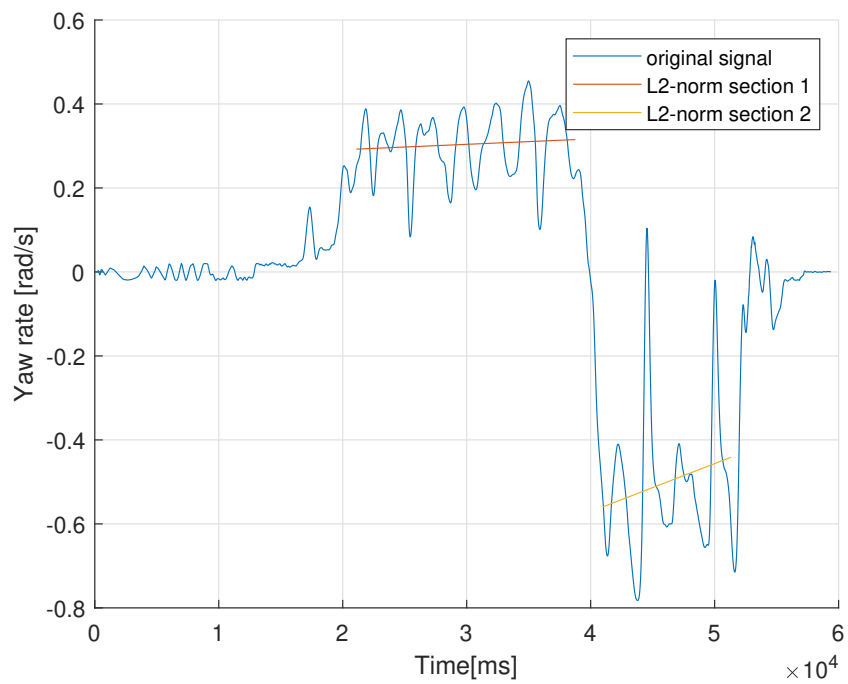
- BAS ■ Brake assist system
- BBW ■ Brake-by-wire
- csv ■ Comma-separated values
- CTU ■ Czech technical university in Prague
- DBW ■ Drive-by-wire
- FBW ■ Fly-by-wire
- FEE ■ Faculty of Electrical Engineering
- LFS ■ Live for Speed
- SAE ■ Society of Automobile Engineers
- SBW ■ Steer-by-wire
- SUV ■ Sport utility vehicle
- TBW ■ Throttle-by-wire
- UDP ■ User Datagram Protocol
- 6DOF ■ Six degrees of freedom

# Appendix B

## Ride logs

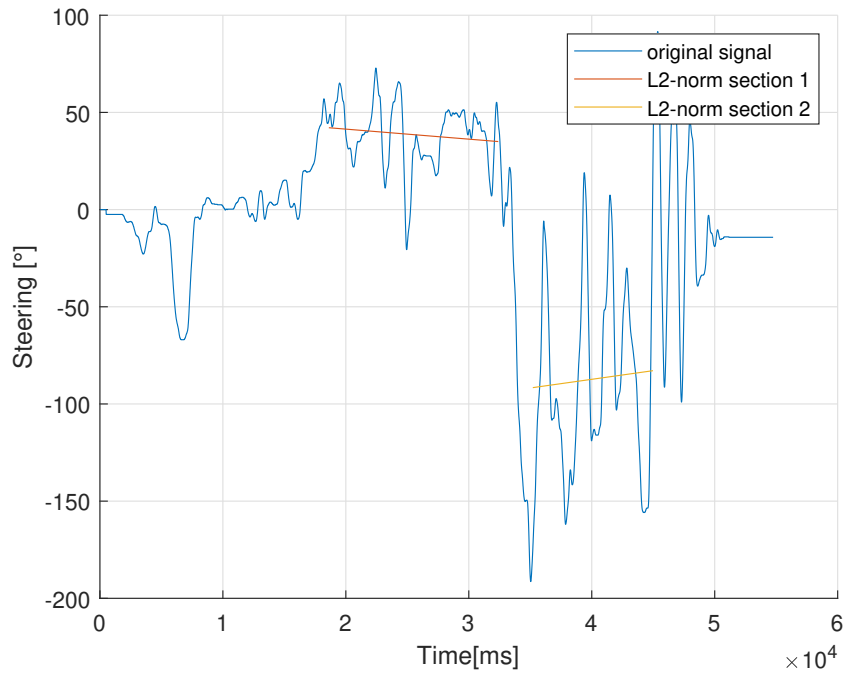


**Figure B.1.** Average steering deviation: 7.583 [°], Rating: 5

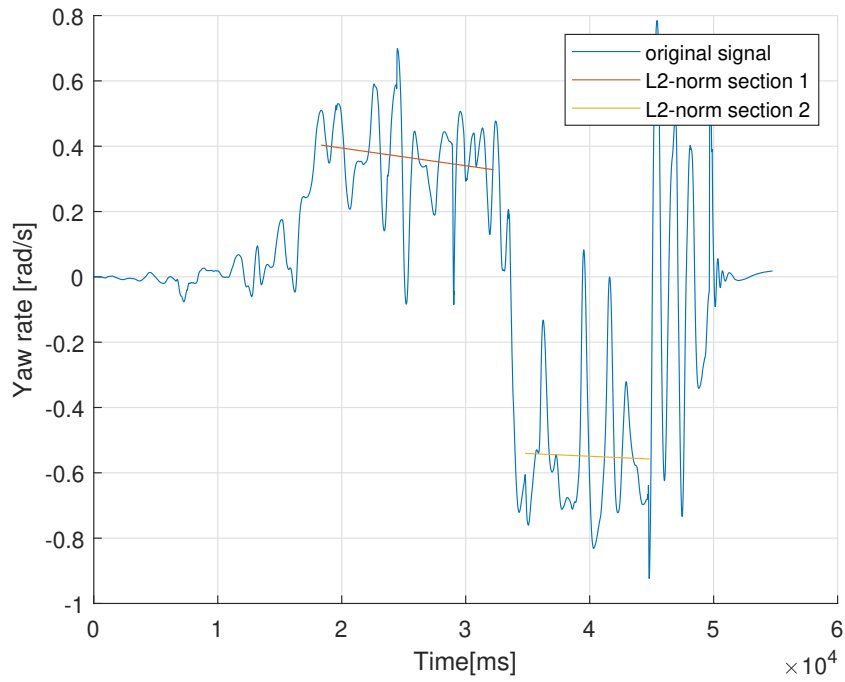


**Figure B.2.** Average yaw rate deviation: 0.084 [rad/s], Rating: 5

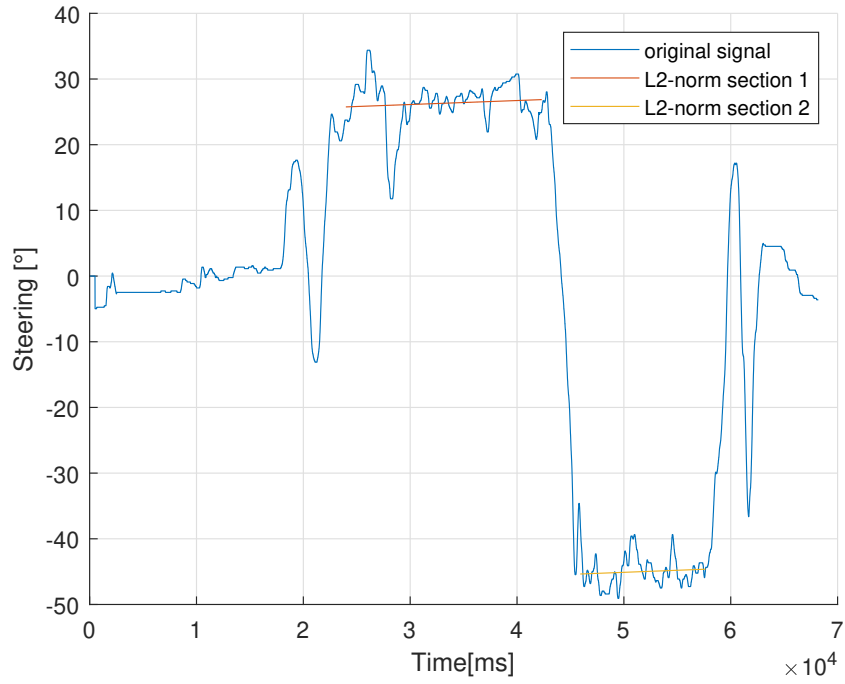




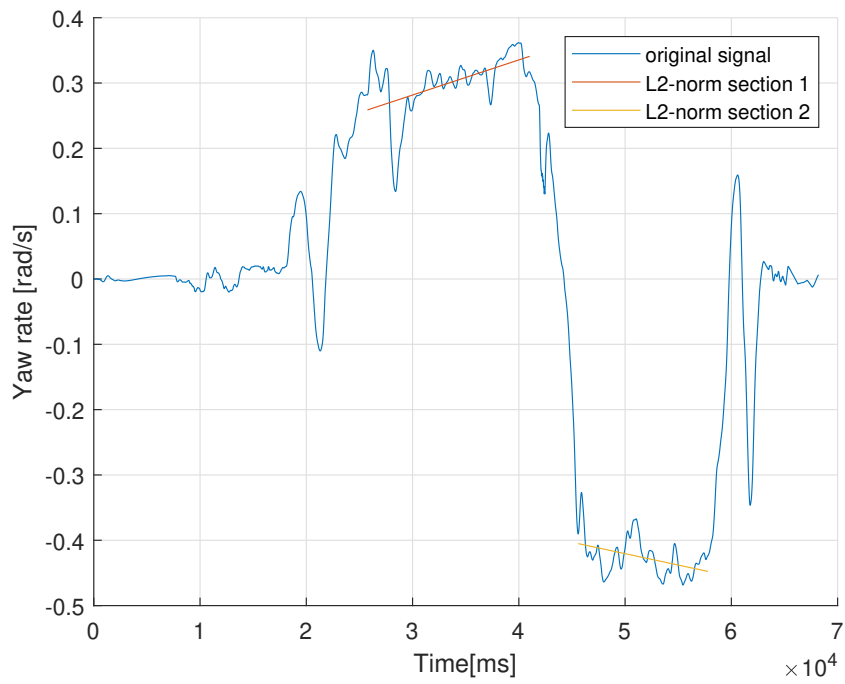
**Figure B.3.** Average steering deviation: 23.9 [°], Rating: 2



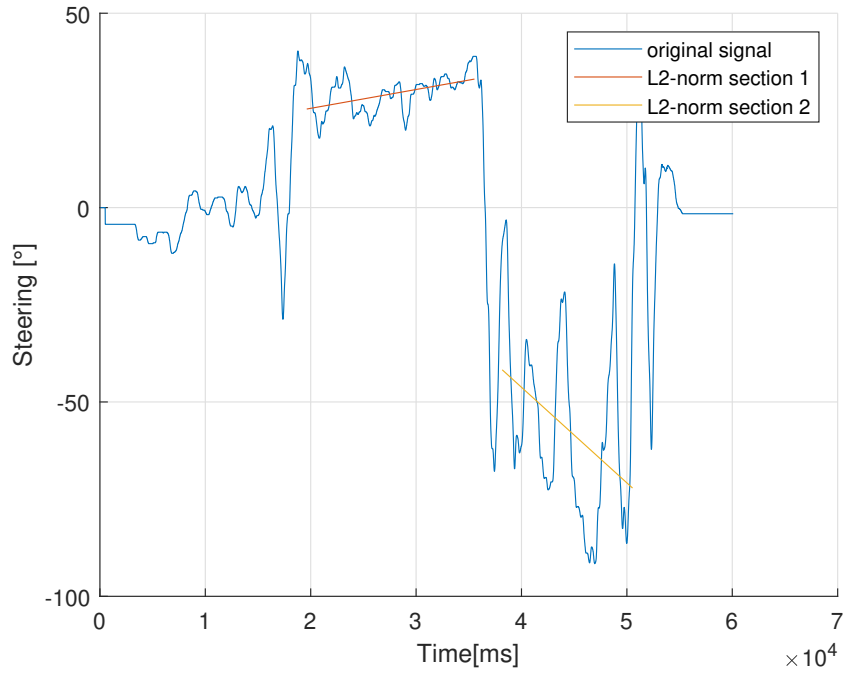
**Figure B.4.** Average yaw rate deviation: 0.127 [rad/s], Rating: 2



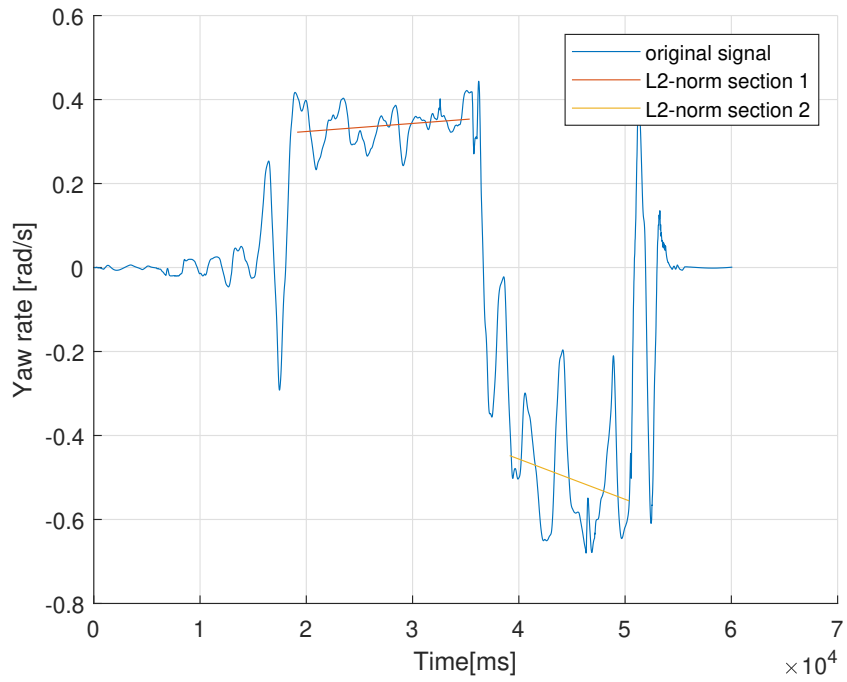
**Figure B.5.** Average steering deviation: 2.26 [°], Rating: 5



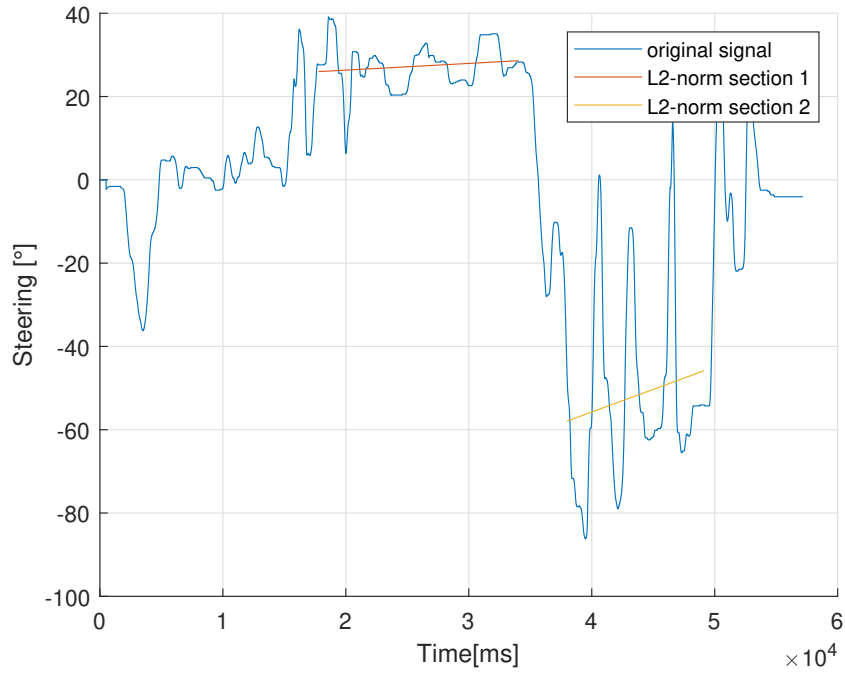
**Figure B.6.** Average yaw rate deviation: 0.023 [rad/s], Rating: 5



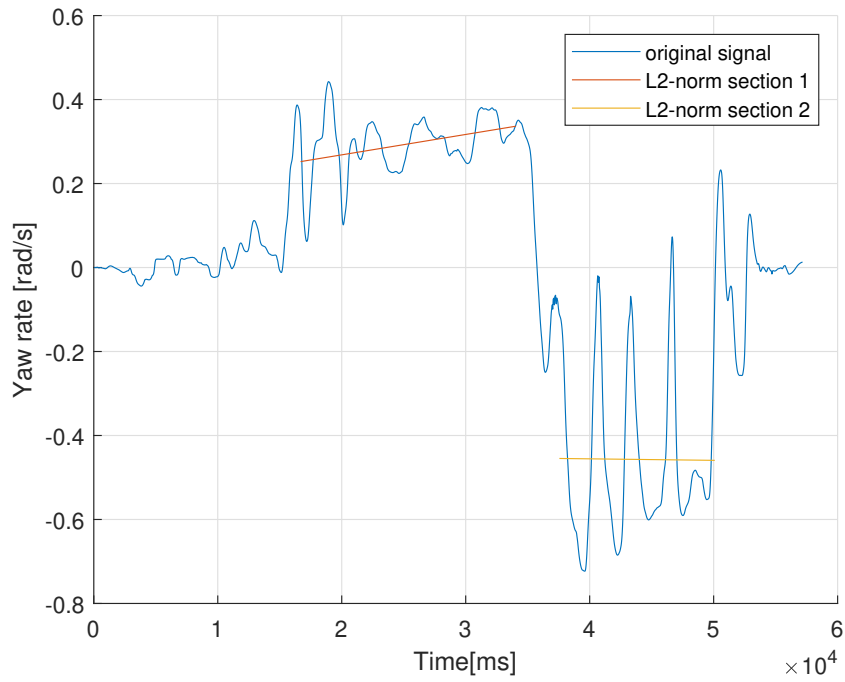
**Figure B.7.** Average steering deviation: 9.32 [°], Rating: 5



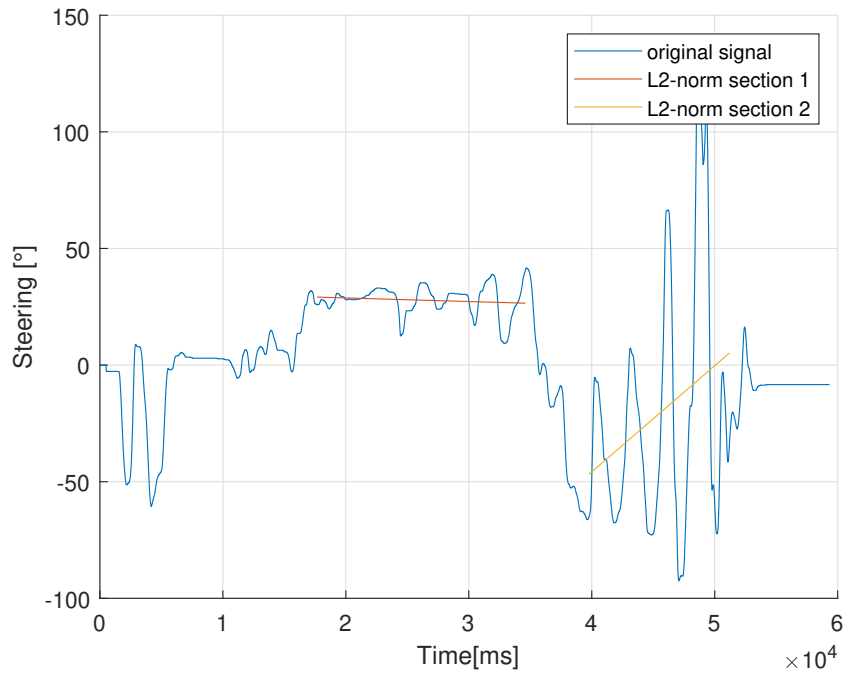
**Figure B.8.** Average yaw rate deviation: 0.023 [rad/s], Rating: 5



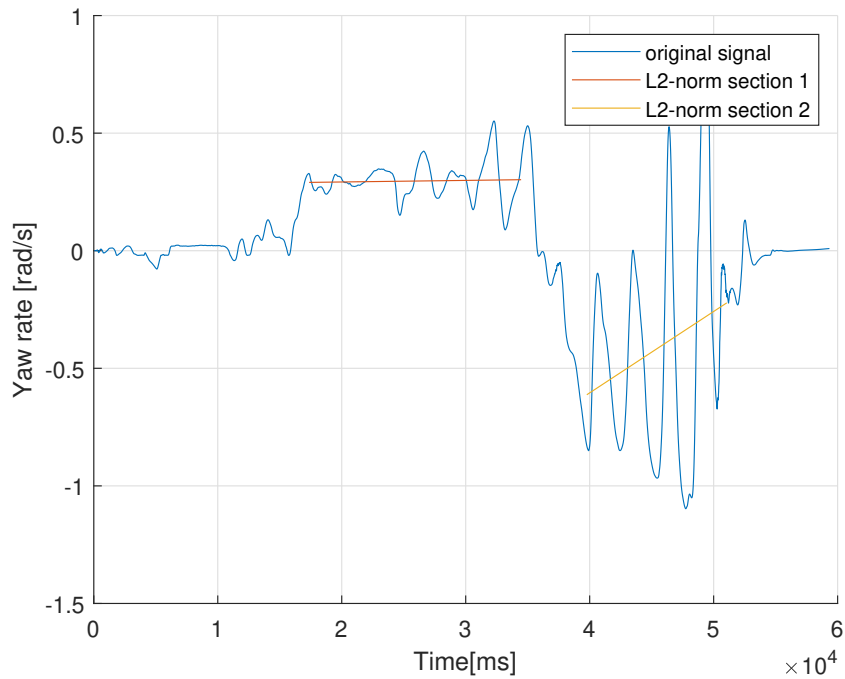
**Figure B.9.** Average steering deviation: 9.612 [°], Rating: 5



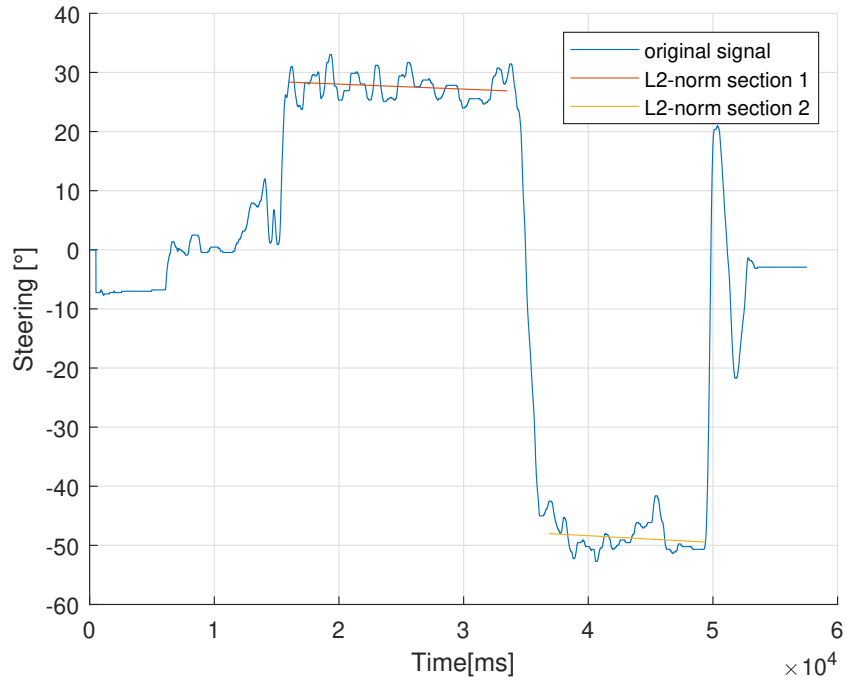
**Figure B.10.** Average yaw rate deviation: 0.094 [rad/s], Rating: 5



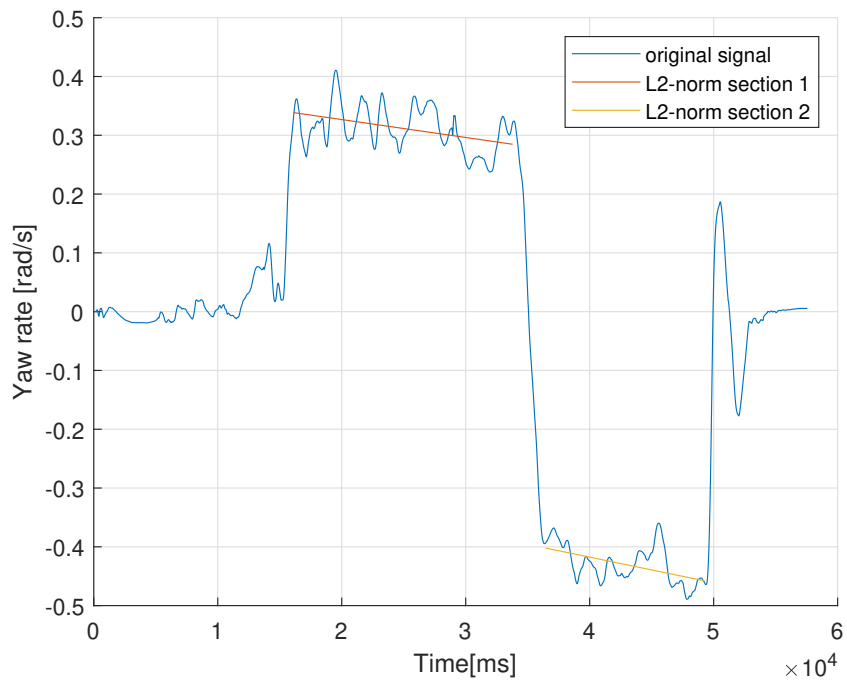
**Figure B.11.** Average steering deviation: 19.01 [°], Rating: 3



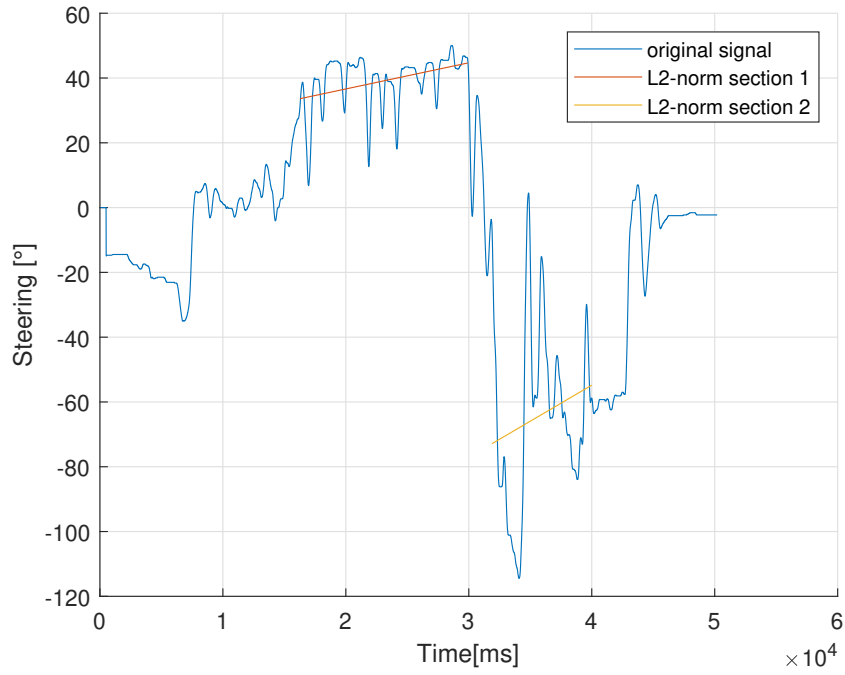
**Figure B.12.** Average yaw rate deviation: 0.19 [rad/s], Rating: 3



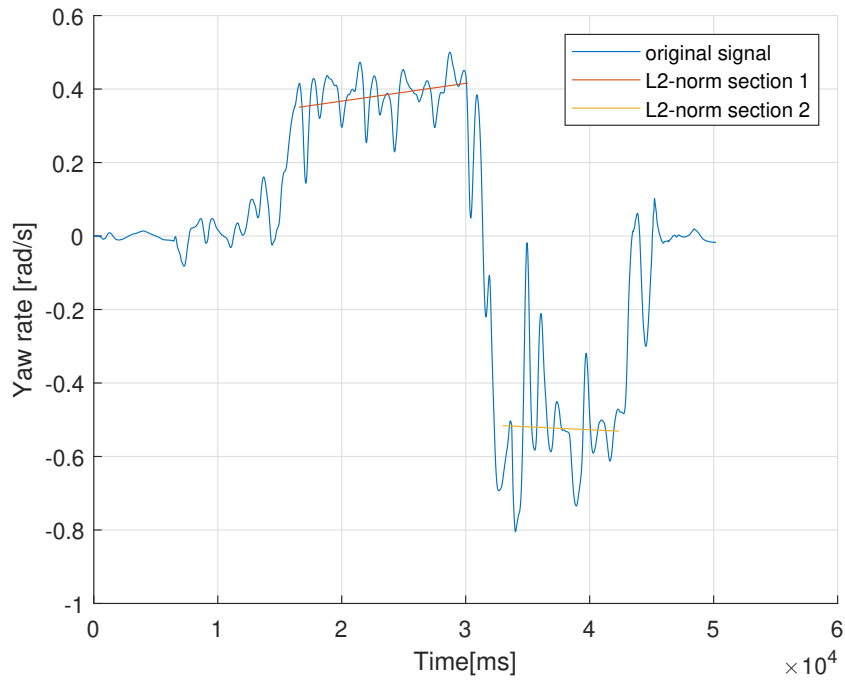
**Figure B.13.** Average steering deviation: 1.843 [°], Rating: 5



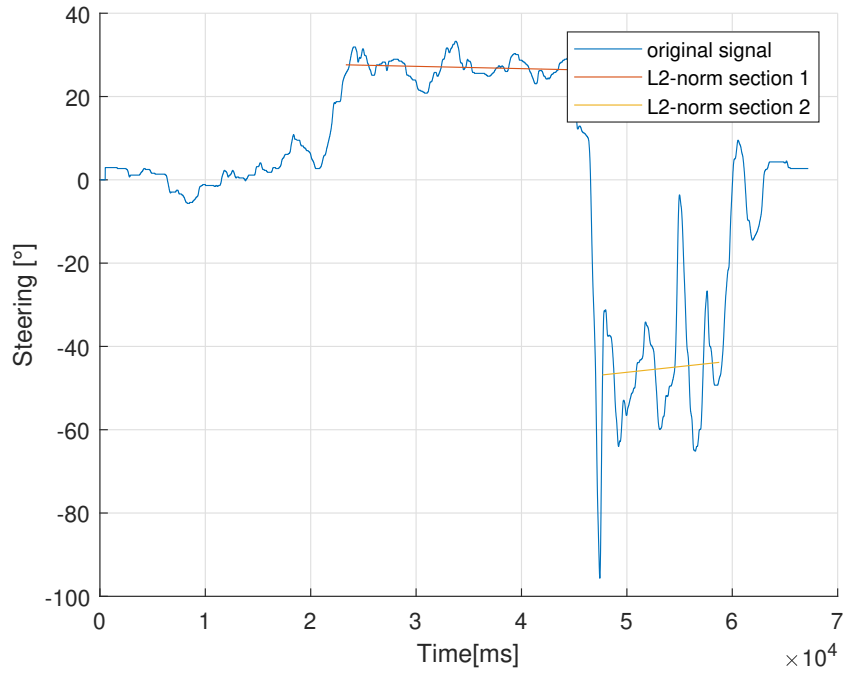
**Figure B.14.** Average yaw rate deviation: 0.026 [rad/s], Rating: 5



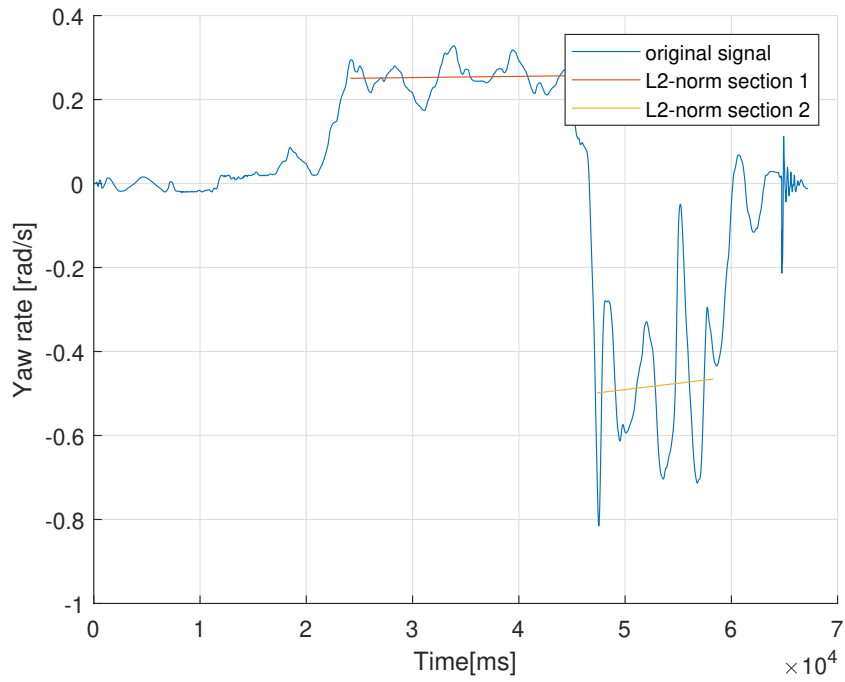
**Figure B.15.** Average steering deviation: 11.457 [°], Rating: 7



**Figure B.16.** Average yaw rate deviation: 0.067 [rad/s], Rating: 7

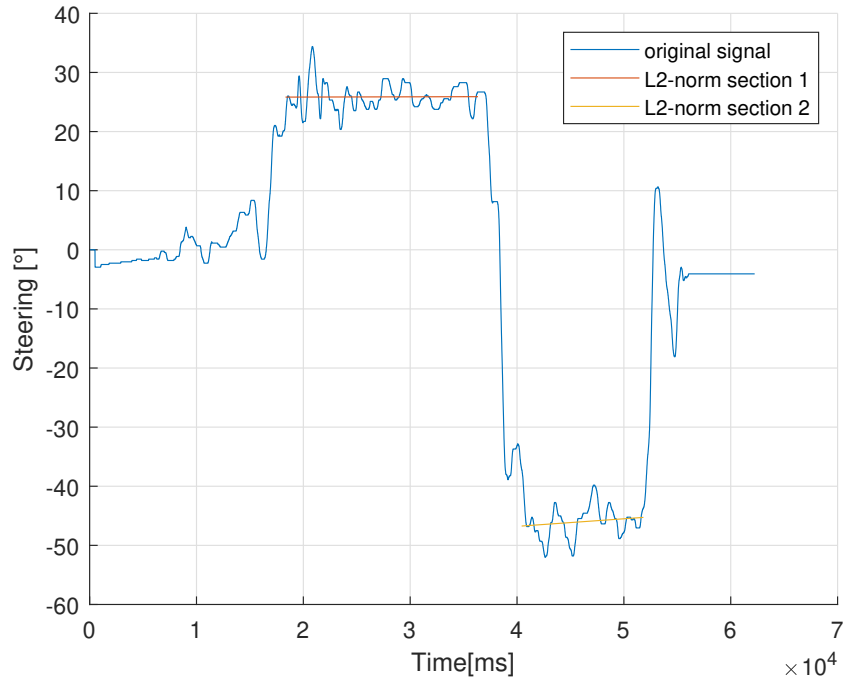


**Figure B.17.** Average steering deviation: 4.83 [°], Rating: 6

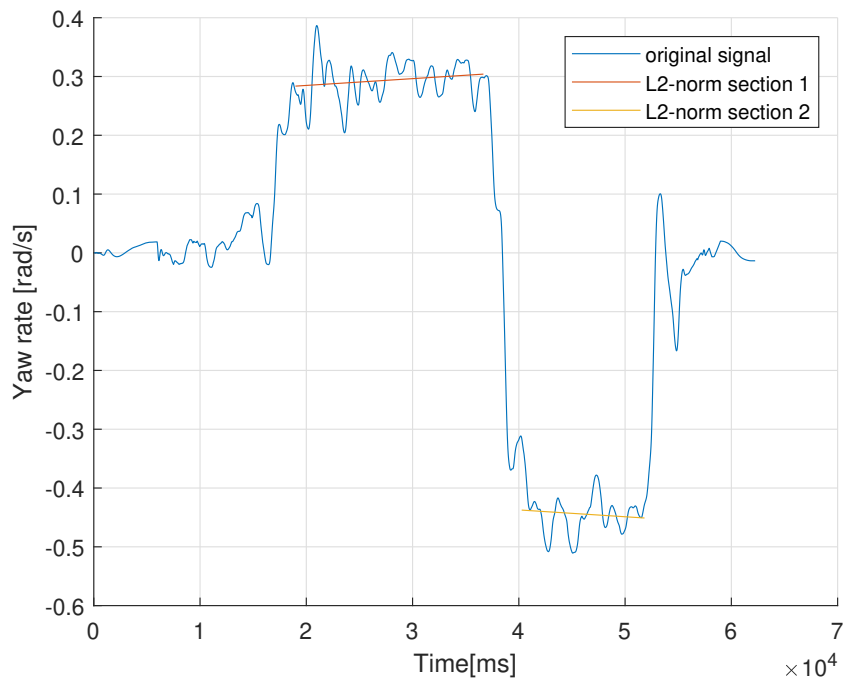


**Figure B.18.** Average yaw rate deviation: 0.067 [rad/s], Rating: 6

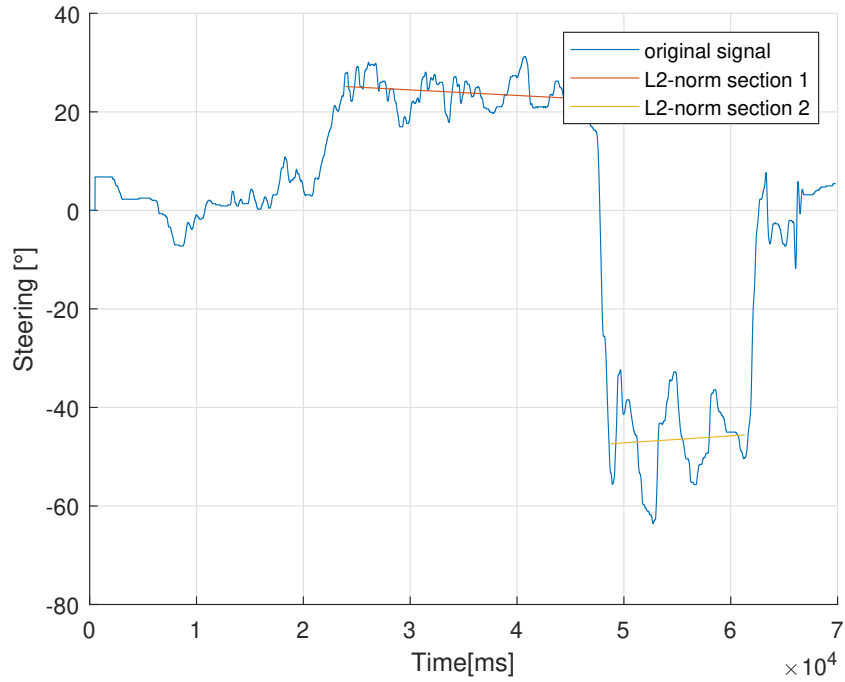




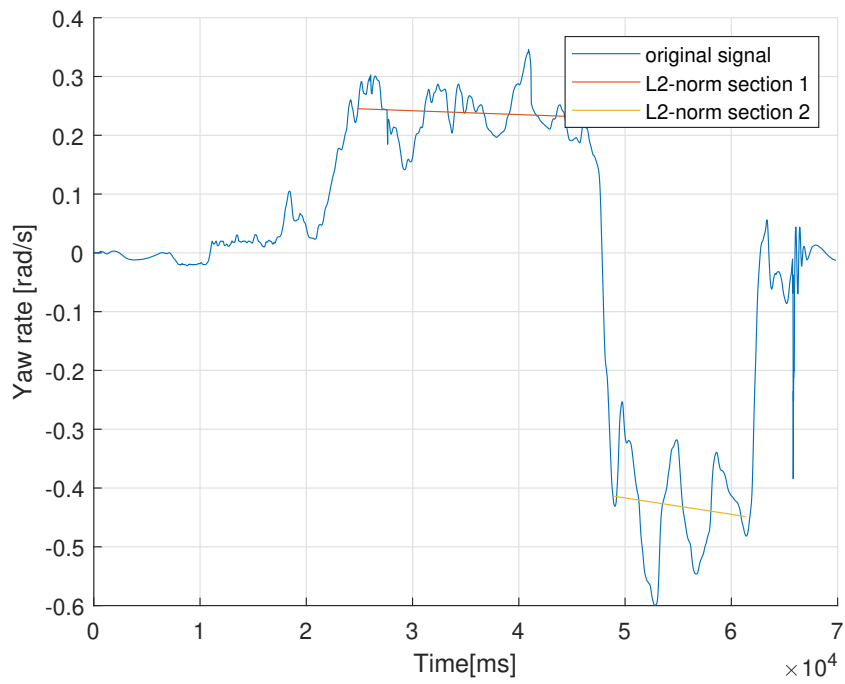
**Figure B.19.** Average steering deviation: 1.832 [°], Rating: 5



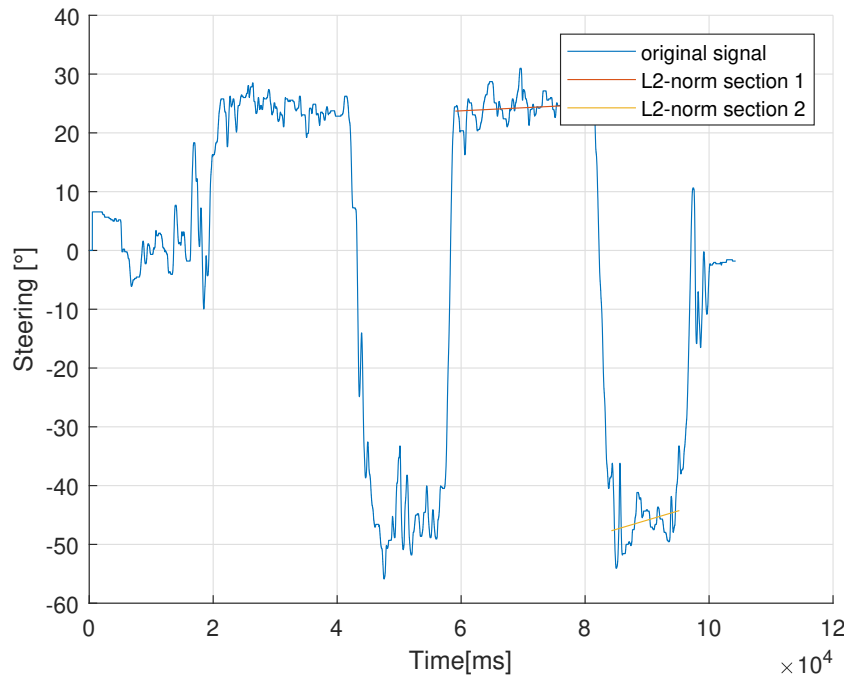
**Figure B.20.** Average yaw rate deviation: 0.026 [rad/s], Rating: 5



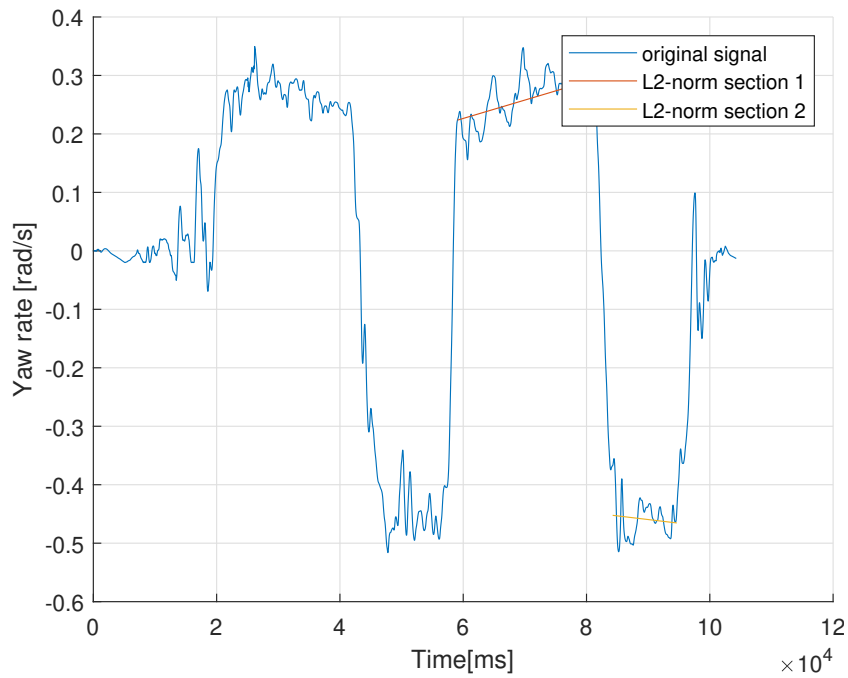
**Figure B.21.** Average steering deviation: 4.055 [°], Rating: 6



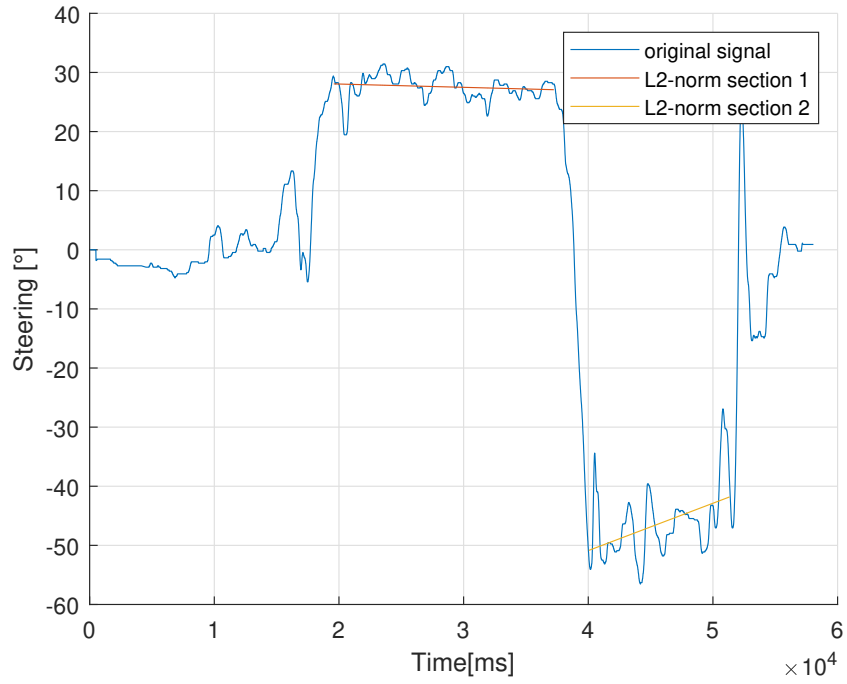
**Figure B.22.** Average yaw rate deviation: 0.046 [rad/s], Rating: 6



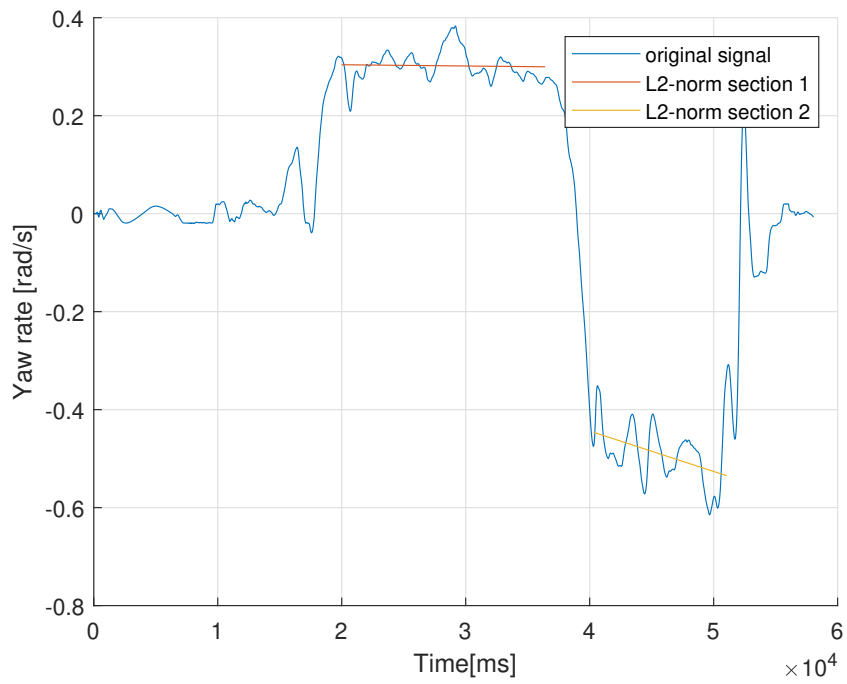
**Figure B.23.** Average steering deviation: 2.132 [°], Rating: 5



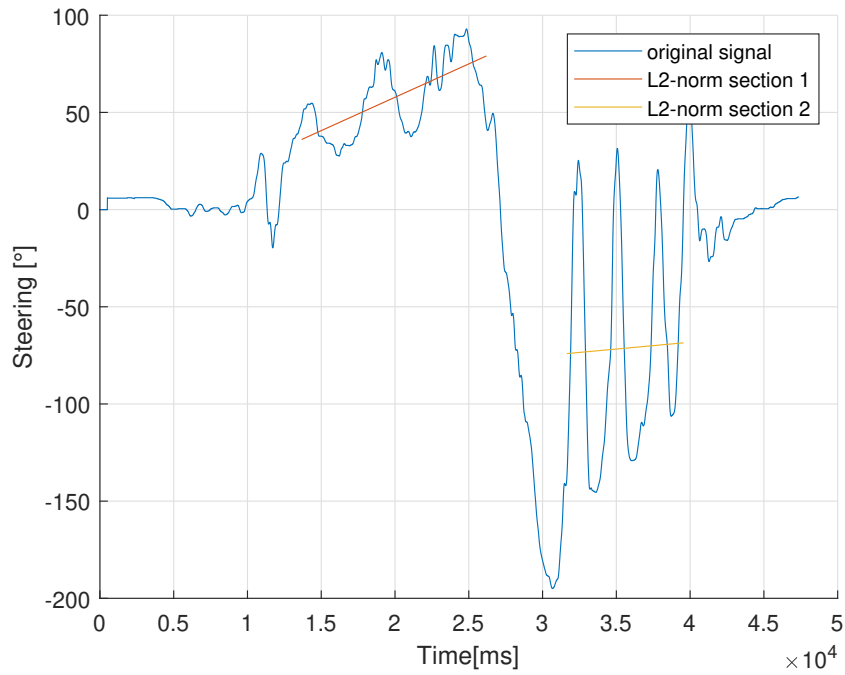
**Figure B.24.** Average yaw rate deviation: 0.025 [rad/s], Rating: 5



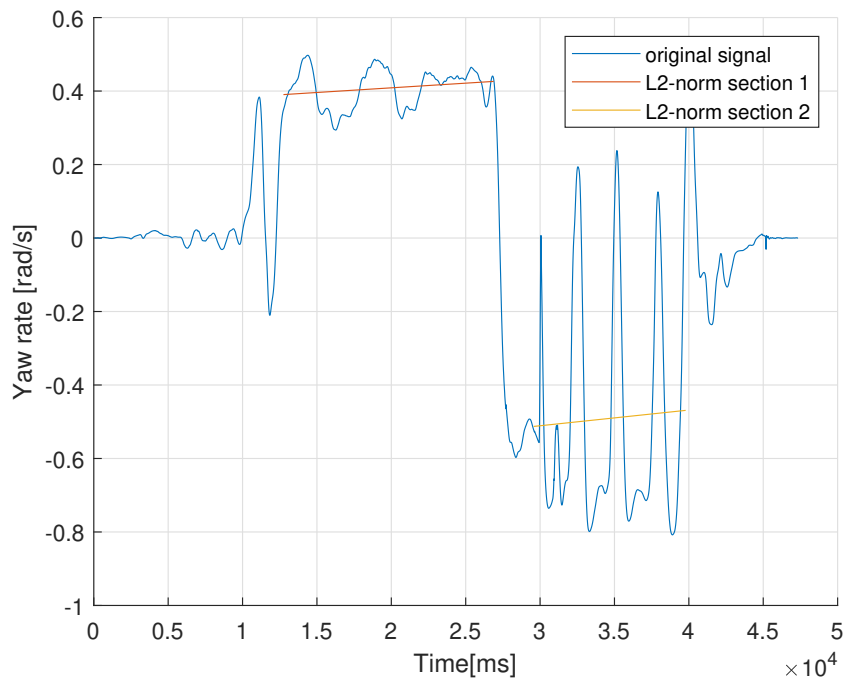
**Figure B.25.** Average steering deviation: 2.48 [°], Rating: 6



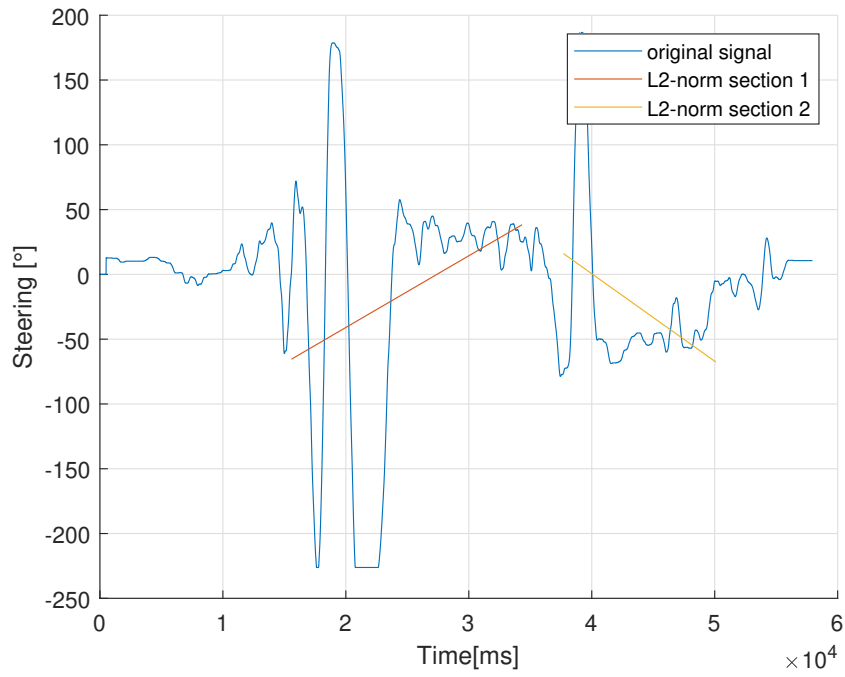
**Figure B.26.** Average yaw rate deviation: 0.031 [rad/s], Rating: 6



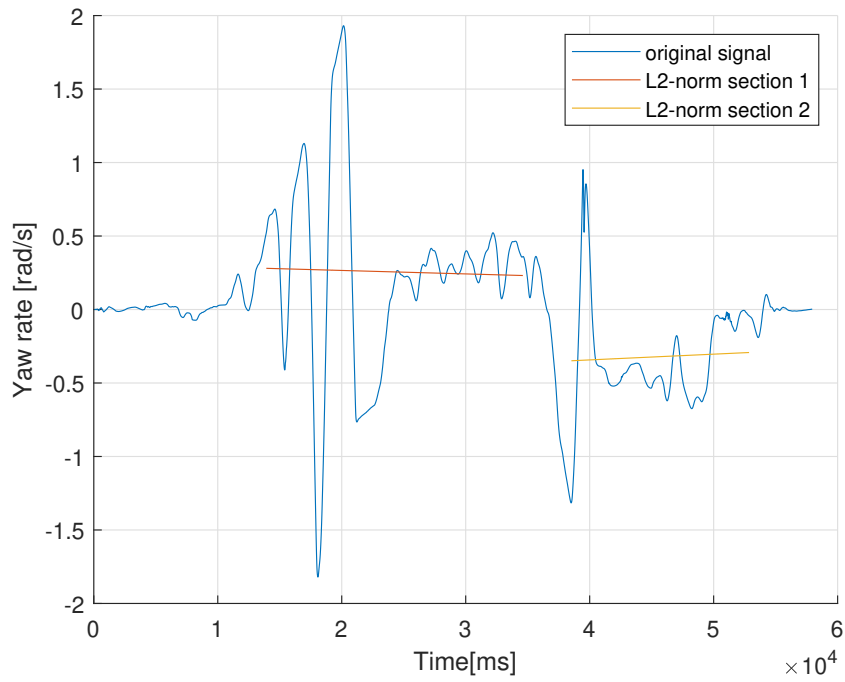
**Figure B.27.** Average steering deviation: 26.432 [°], Rating: 3



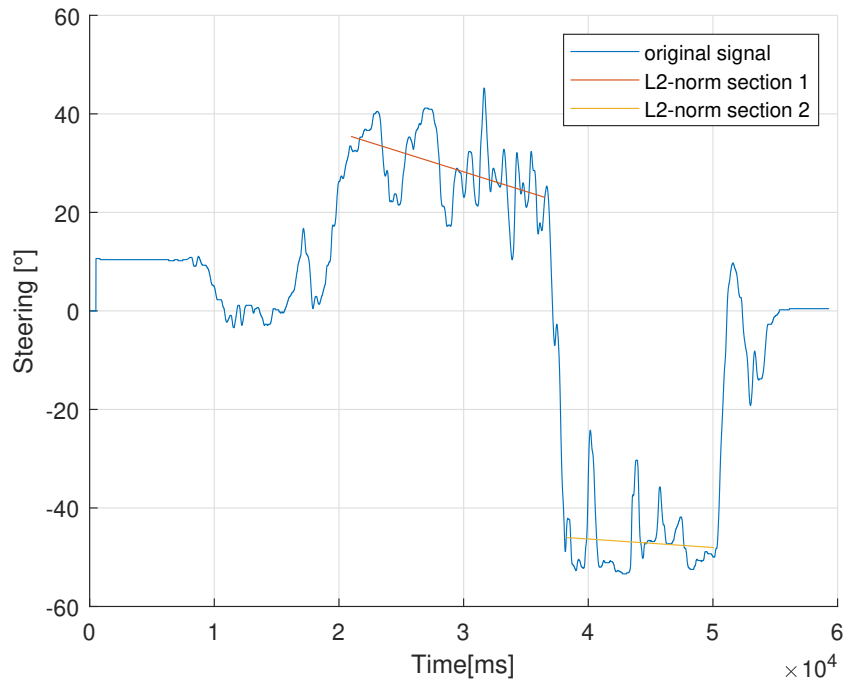
**Figure B.28.** Average yaw rate deviation: 0.133 [rad/s], Rating: 3



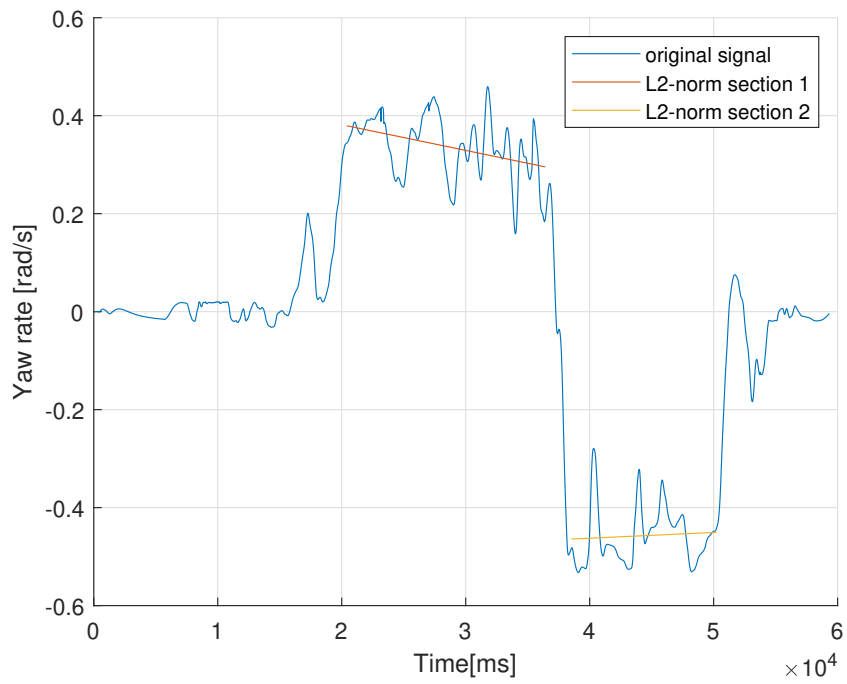
**Figure B.29.** Average steering deviation: 61.345 [°], Rating: 2



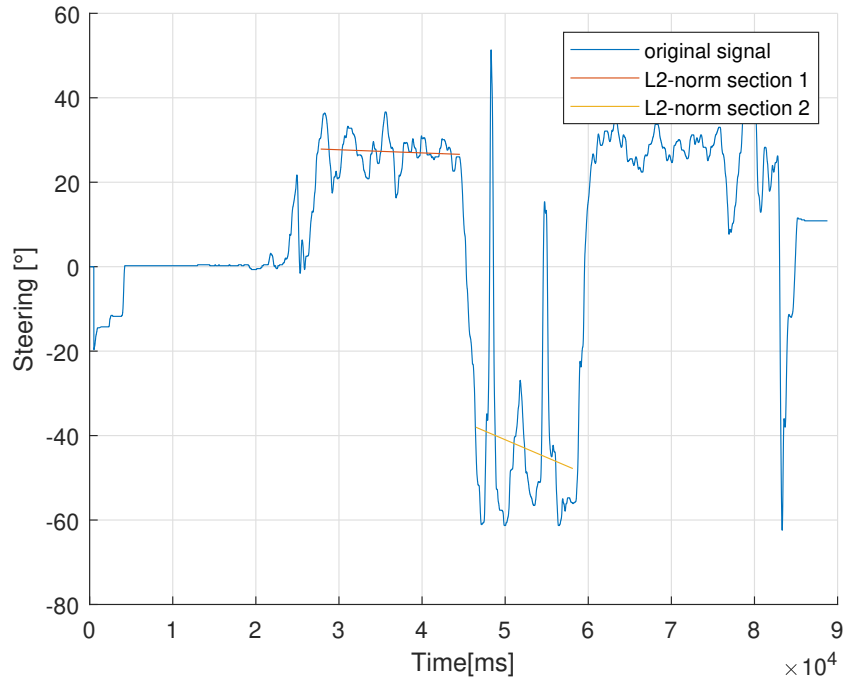
**Figure B.30.** Average yaw rate deviation: 0.356 [rad/s], Rating: 2



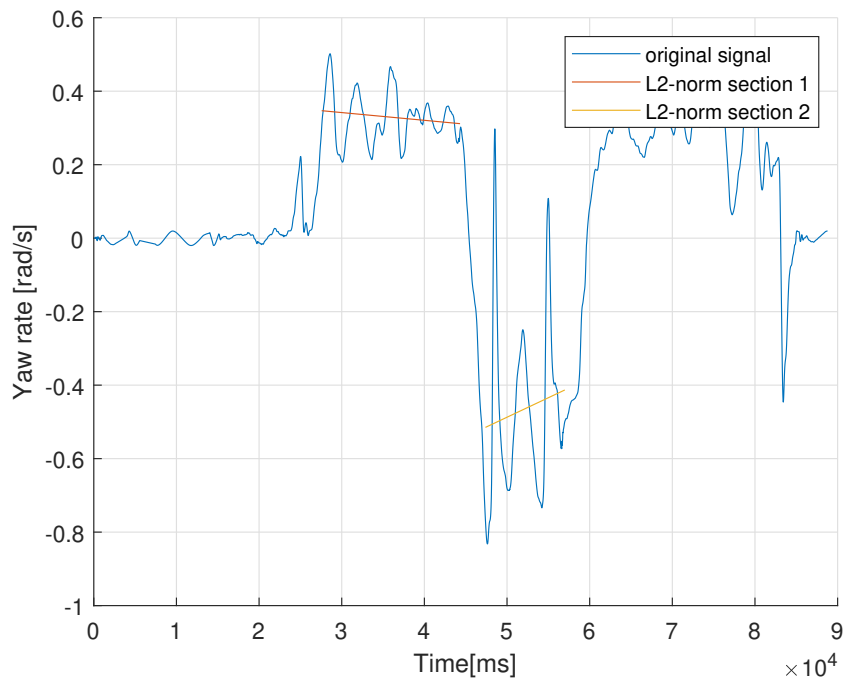
**Figure B.31.** Average steering deviation: 5.037 [°], Rating: 6



**Figure B.32.** Average yaw rate deviation: 0.045 [rad/s], Rating: 6

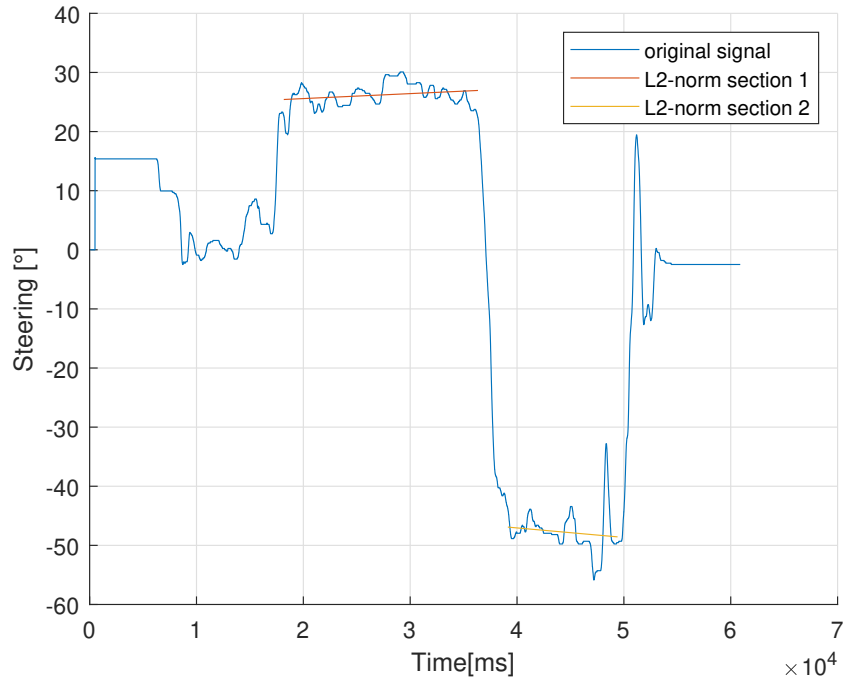


**Figure B.33.** Average steering deviation: 8.125 [°], Rating: 6

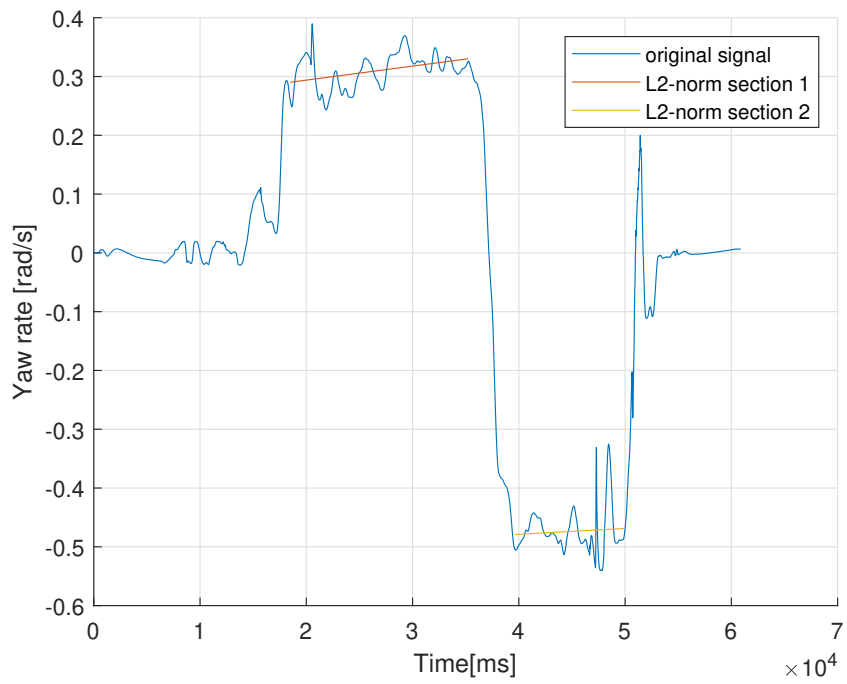


**Figure B.34.** Average yaw rate deviation: 0.101 [rad/s], Rating: 6

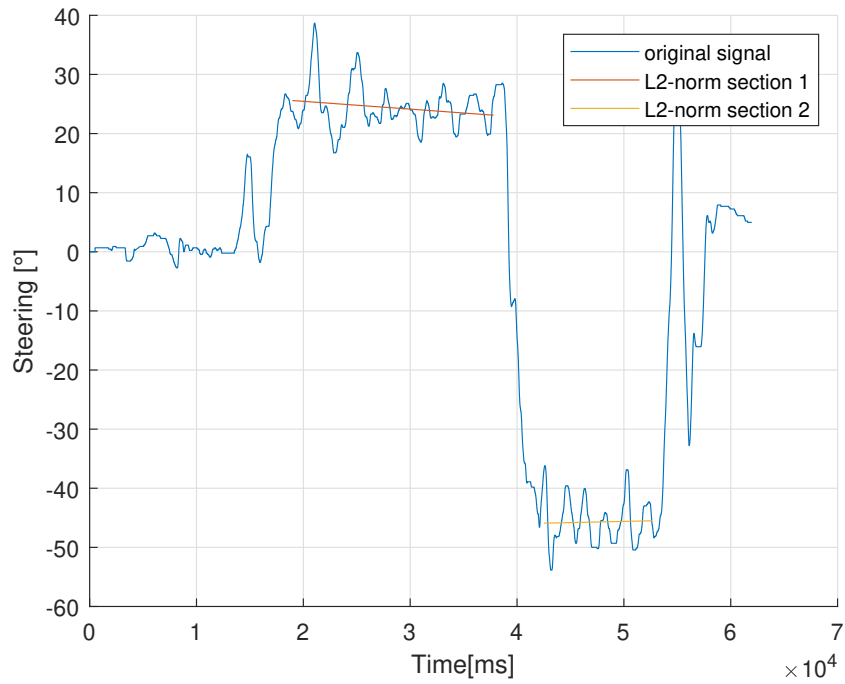




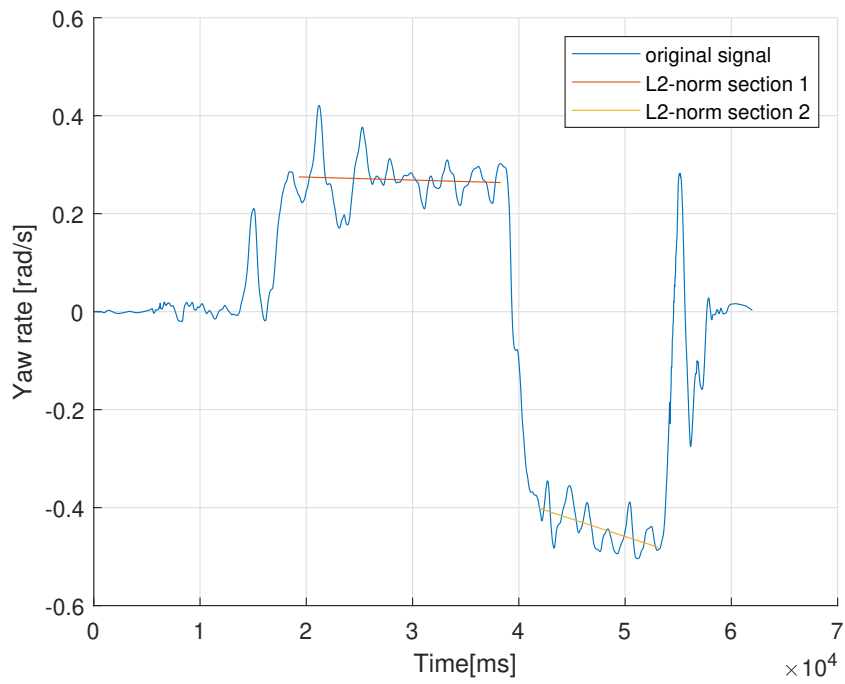
**Figure B.35.** Average steering deviation: 1.853 [°], Rating: 7



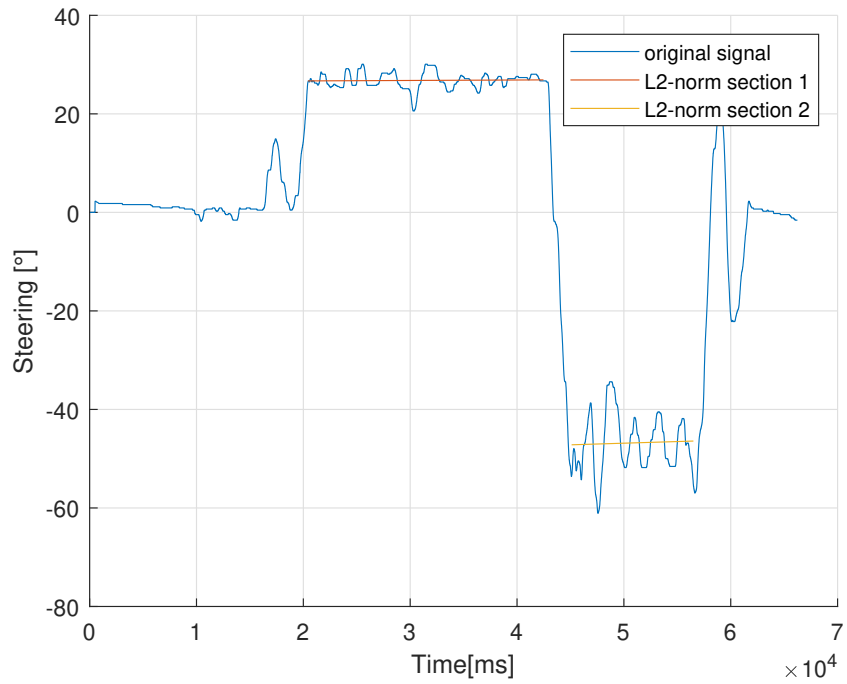
**Figure B.36.** Average yaw rate deviation: 0.024 [rad/s], Rating: 7



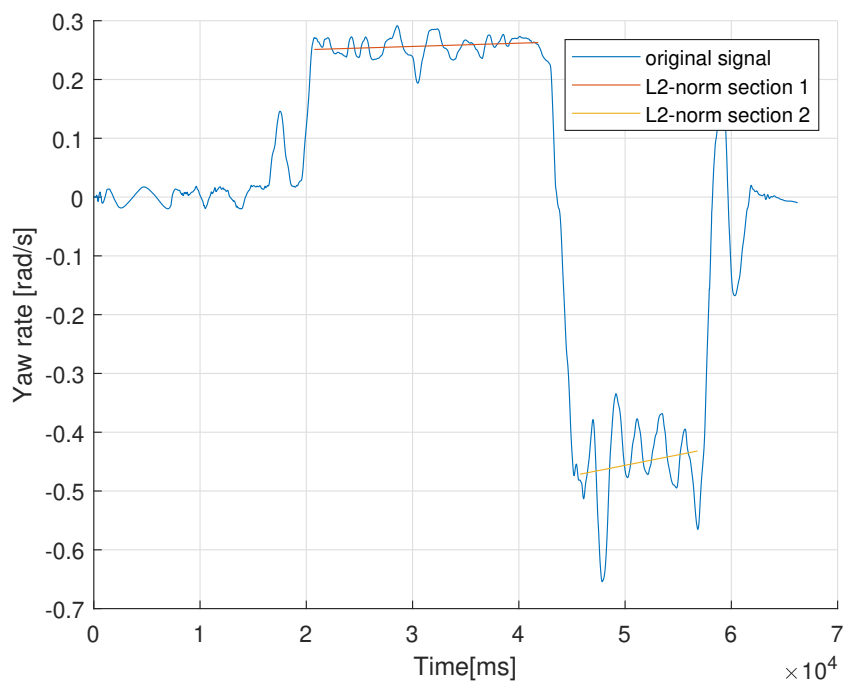
**Figure B.37.** Average steering deviation: 2.955 [°], Rating: 6



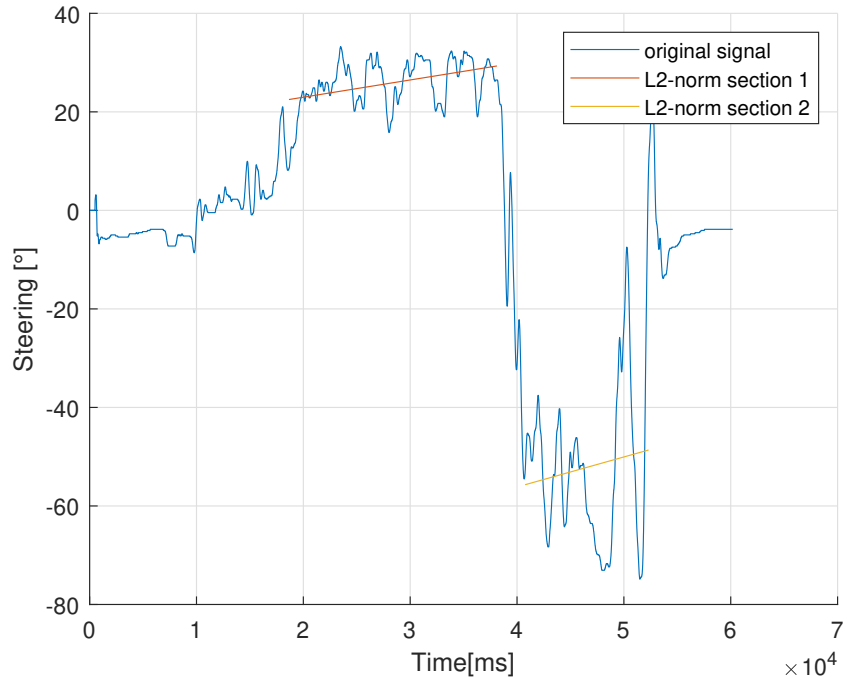
**Figure B.38.** Average yaw rate deviation: 0.003 [rad/s], Rating: 6



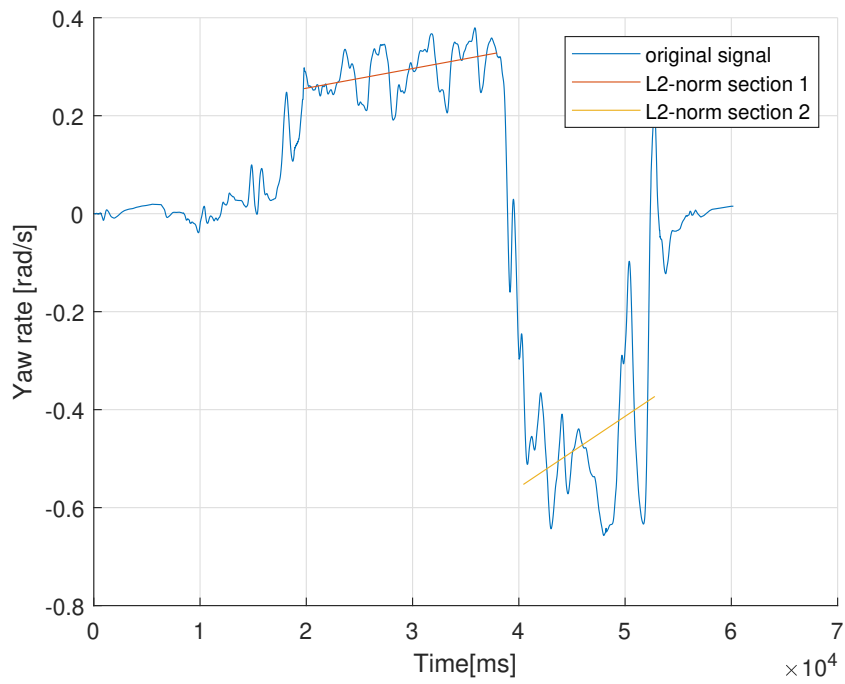
**Figure B.39.** Average steering deviation: 2.434 [°], Rating: 6



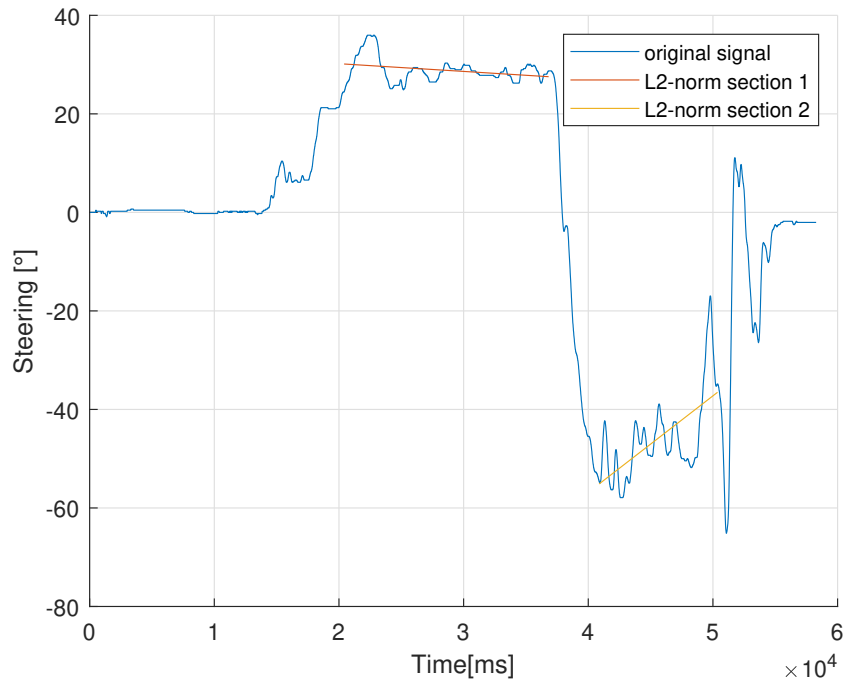
**Figure B.40.** Average yaw rate deviation: 0.026 [rad/s], Rating: 6



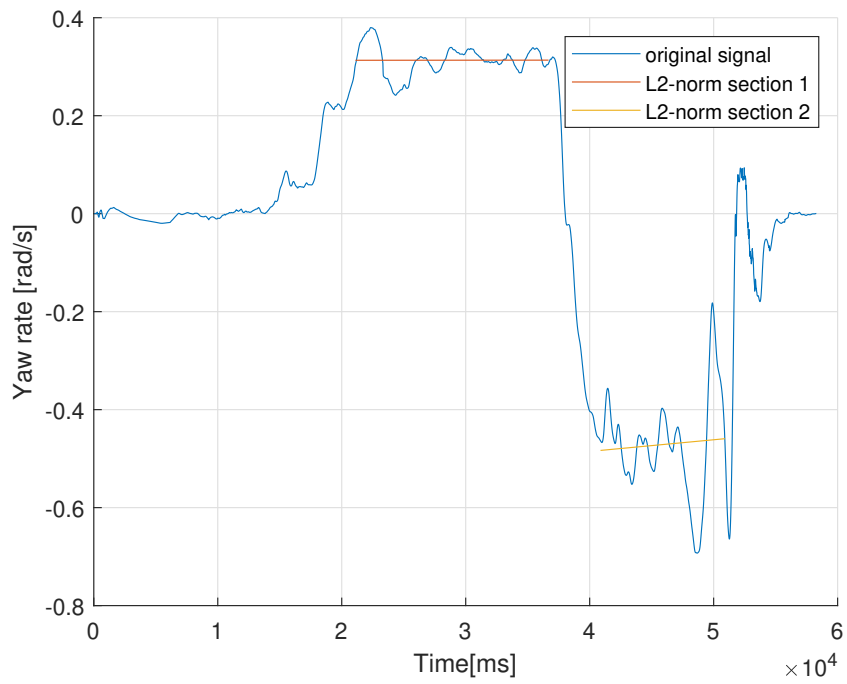
**Figure B.41.** Average steering deviation: 7.015 [°], Rating: 3



**Figure B.42.** Average yaw rate deviation: 0.069 [rad/s], Rating: 3



**Figure B.43.** Average steering deviation: 2.997 [°], Rating: 5



**Figure B.44.** Average yaw rate deviation: 0.043 [rad/s], Rating: 5

# Appendix C

## Car information



Figure C.45. Soft suspension car settings



Figure C.46. Hard suspension car settings