

sběr dat

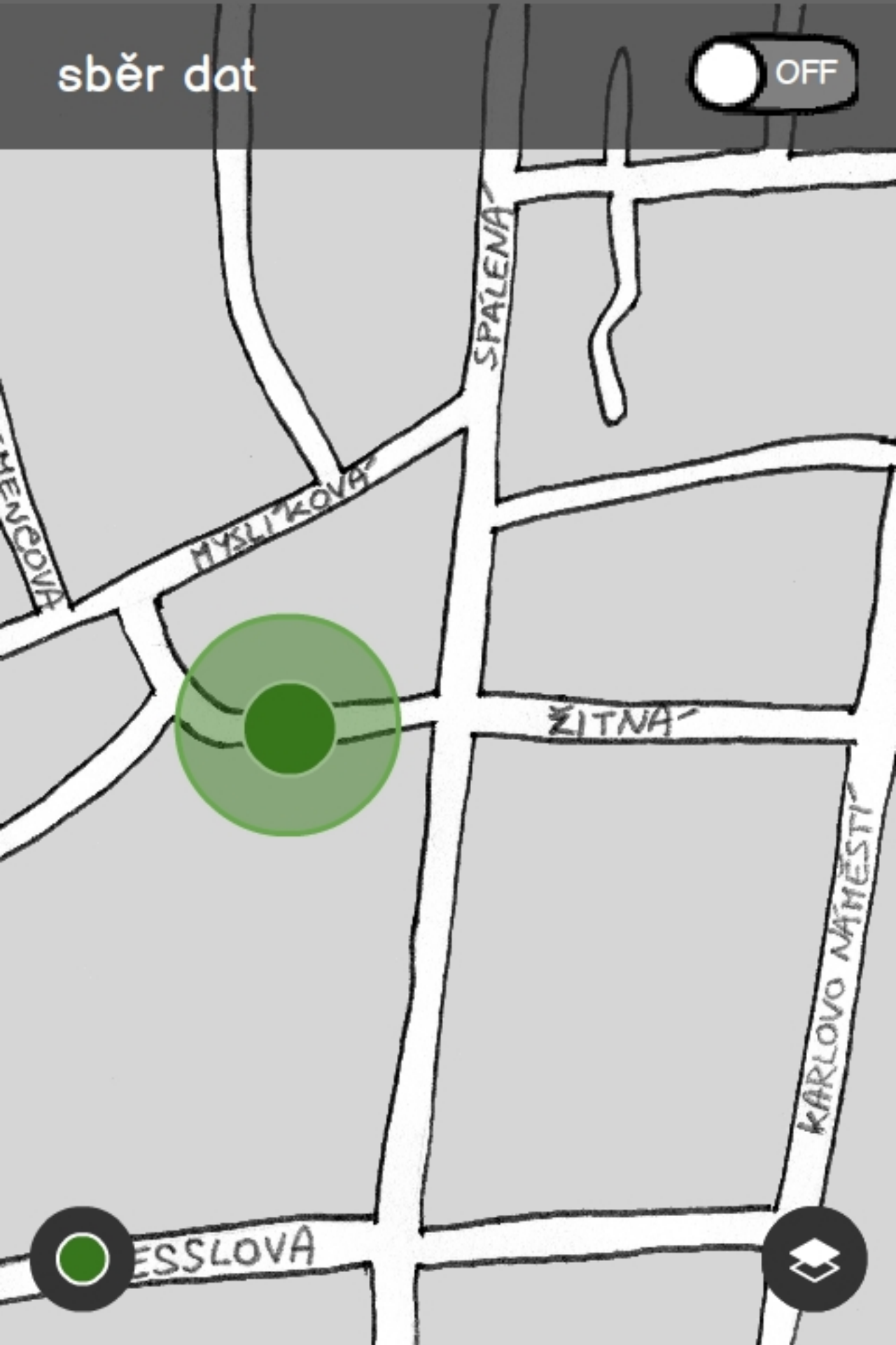

vyhledávání



hra



překážka





přechod



roh



chodník

ON

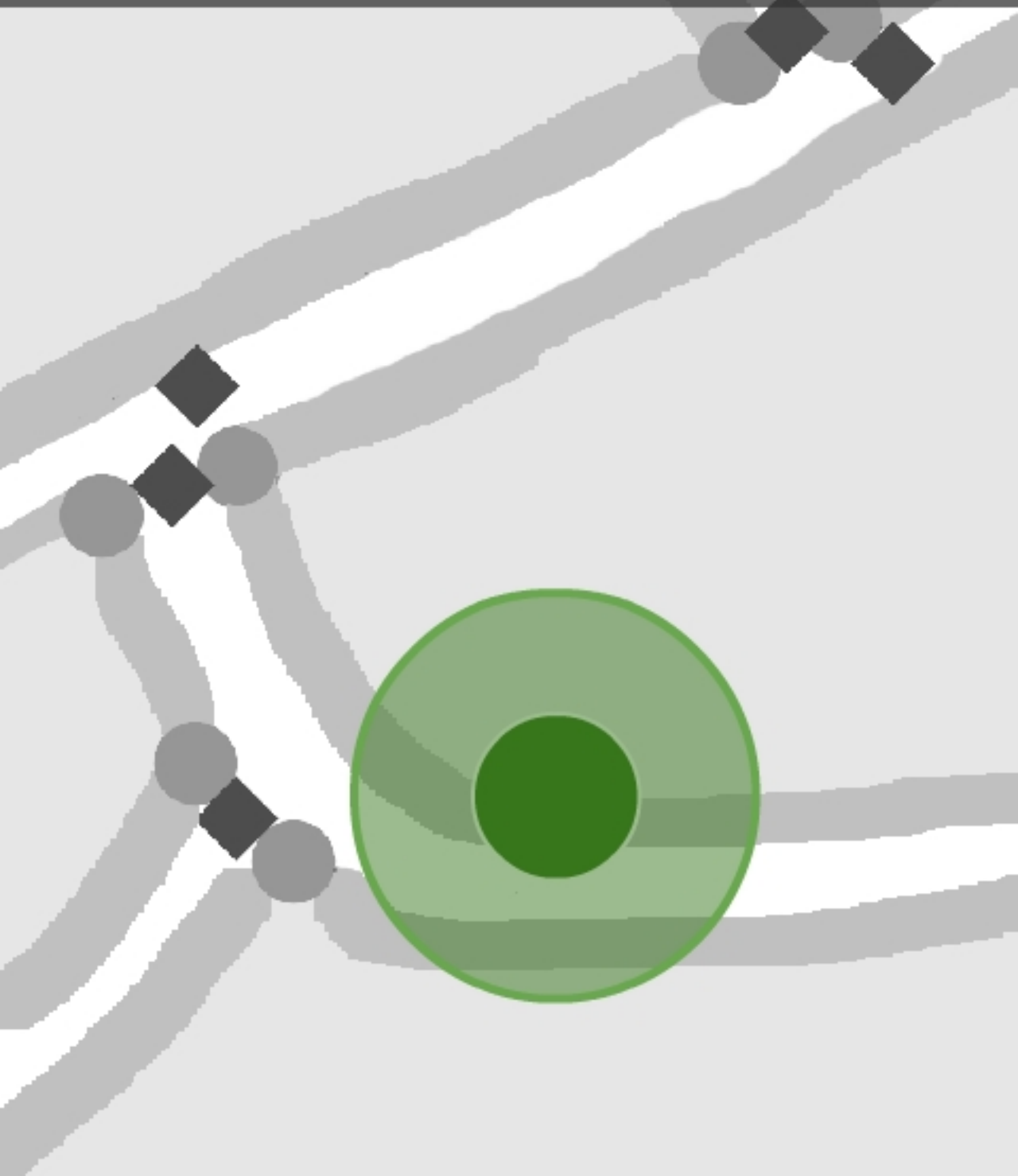

vyhledávání



hra



překážka





Umístěte překážku
posunutím mapy

+3
body

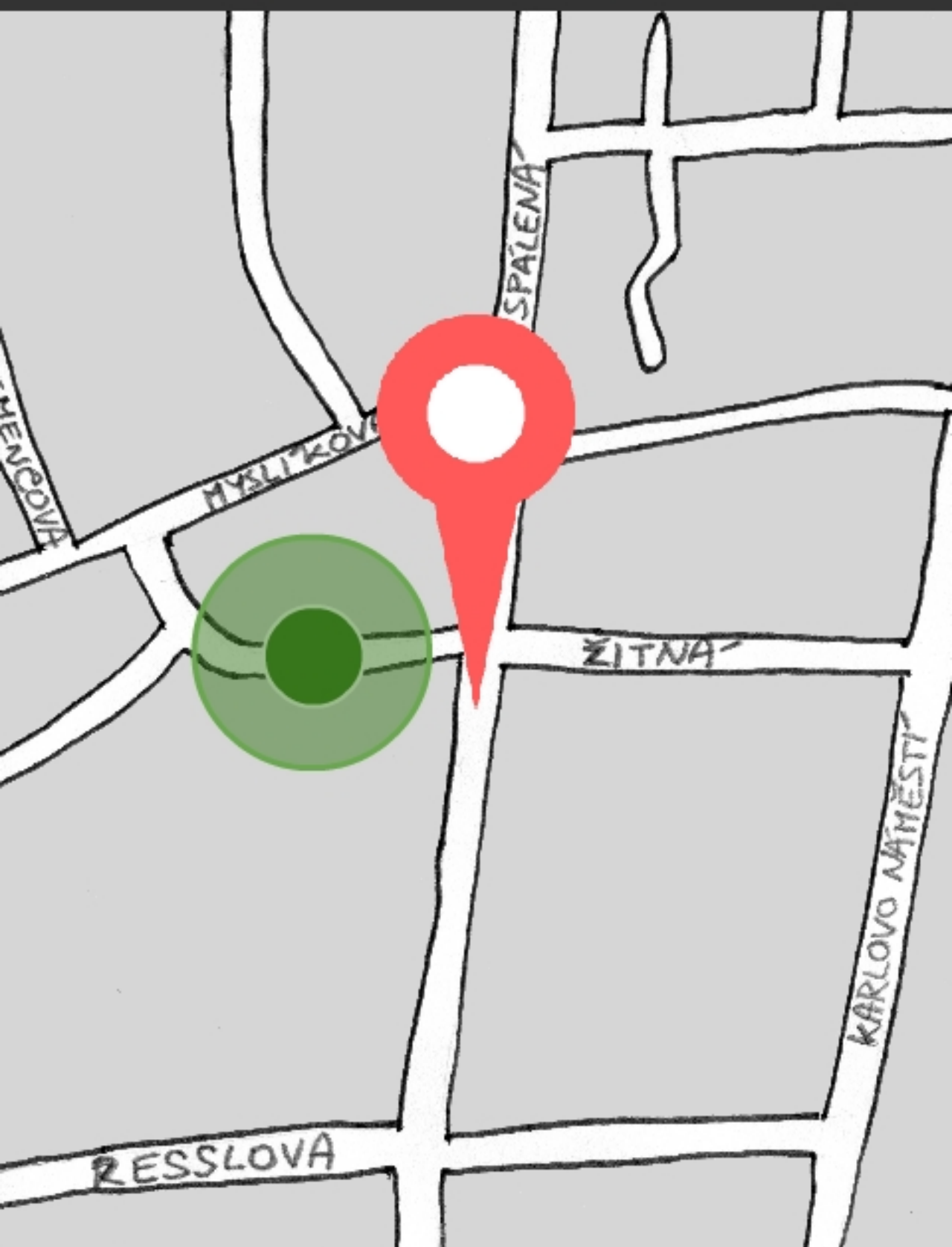

Pokračovat



Umístěte překážku
posunutím mapy

+3
body

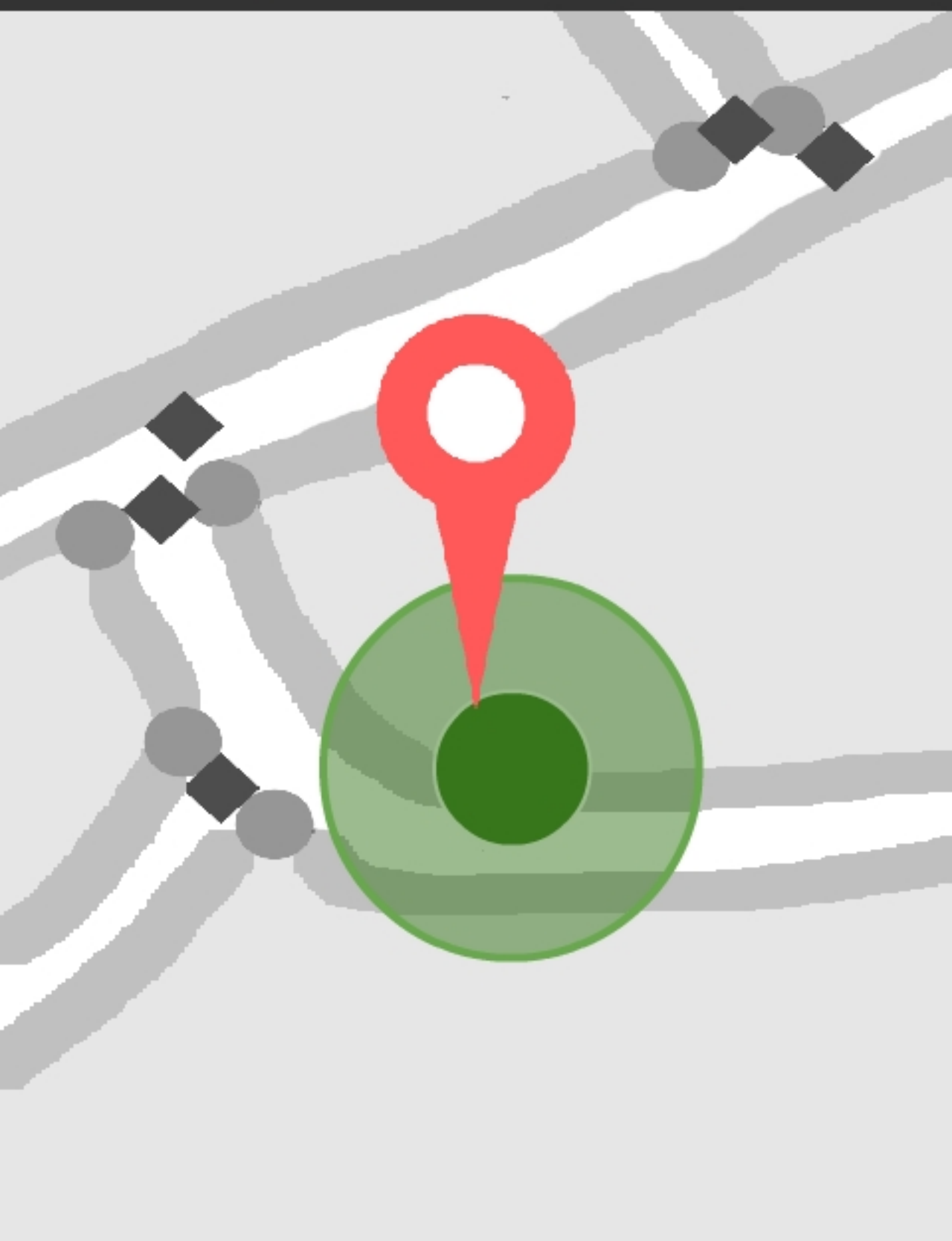

Pokračovat

← Zadejte polohu
překážky a přechodnou
šířku chodníku

+2
body

Poloha překážky ve směru jízdy
nejbližšího jízdního pruhu:

vpravo ▼

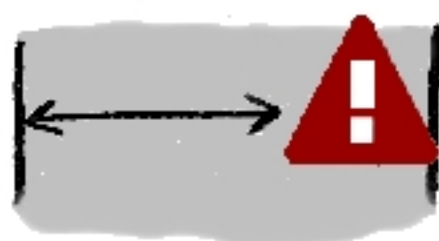

přechodná šířka
50%

překážka
50%

Pokračovat



Vyberte typ překážky

+1
bod



díra



výkop



stopa



koš



strom



lavička



osvětlení



značka



sloup



zábradlí



zastávka



automat

jiný

Pokračovat



Nahrajte fotografii

+3
body



vybrat soubor

Vynechat

Pokračovat



Zadejte rozměry překážky

+5
bodů

Vyberte způsob měření

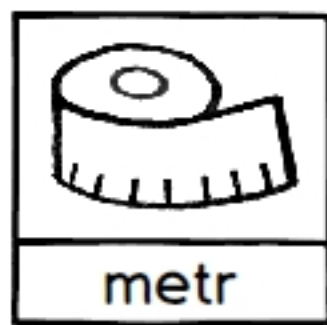

Vynechat

Pokračovat



Zadejte rozměry překážky

+5
bodů

Vyberte způsob měření

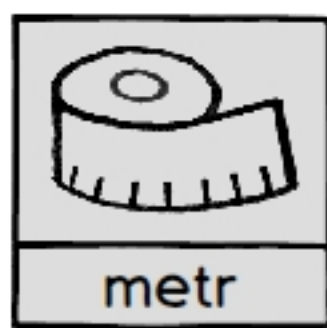

šířka:

cm ▼

délka:

cm ▼

Vynechat

Pokračovat



Zadejte rozměry překážky

+5
bodů

Vyberte způsob měření

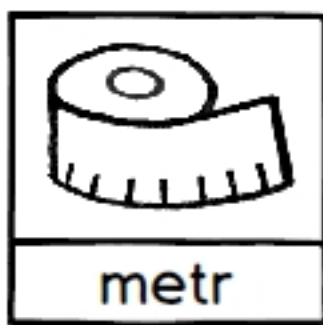

šířka: ▼

délka: ▼

Vynechat

Pokračovat



Zadejte rozměry překážky

+5
bodů

Vyberte způsob měření

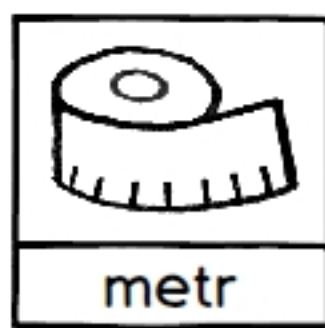

šířka: ▼

délka: ▼

Vynechat

Pokračovat



Je překážka dočasná?

+1
bod

NE

ANO

Vynechat

Pokračovat



Je překážka dočasná?

+1
bod

NE

ANO

Kdy ji máme zkontrolovat?

za

4 dny



Vynechat

Pokračovat



Zkontrolujte zadané informace o překážce

Poloha



Fotografie



Typ: díra v chodníku

Poloha: vpravo

Přechodná šířka: 70%

Rozměry: 8 x 10 kreditek

Životnost: dočasná

Potvrdit



Dnes jste nahráli

15

bodů

a pomohli jste hendikepovaným lidem s bezpečnou navigací.

Děkujeme.

Sdílet

Pokračovat



sběr dat

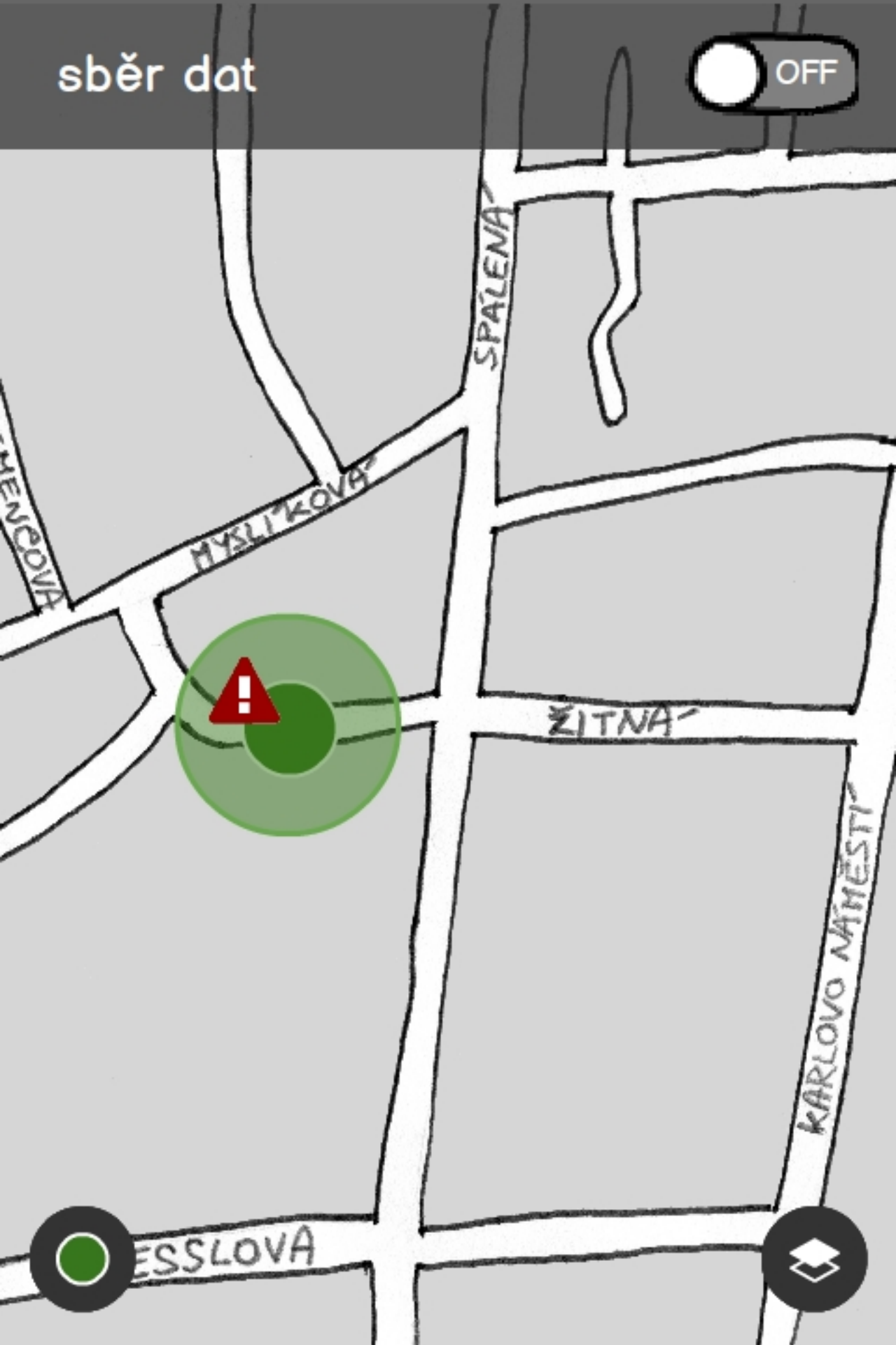

vyhledávání



hra



překážka



sběr dat

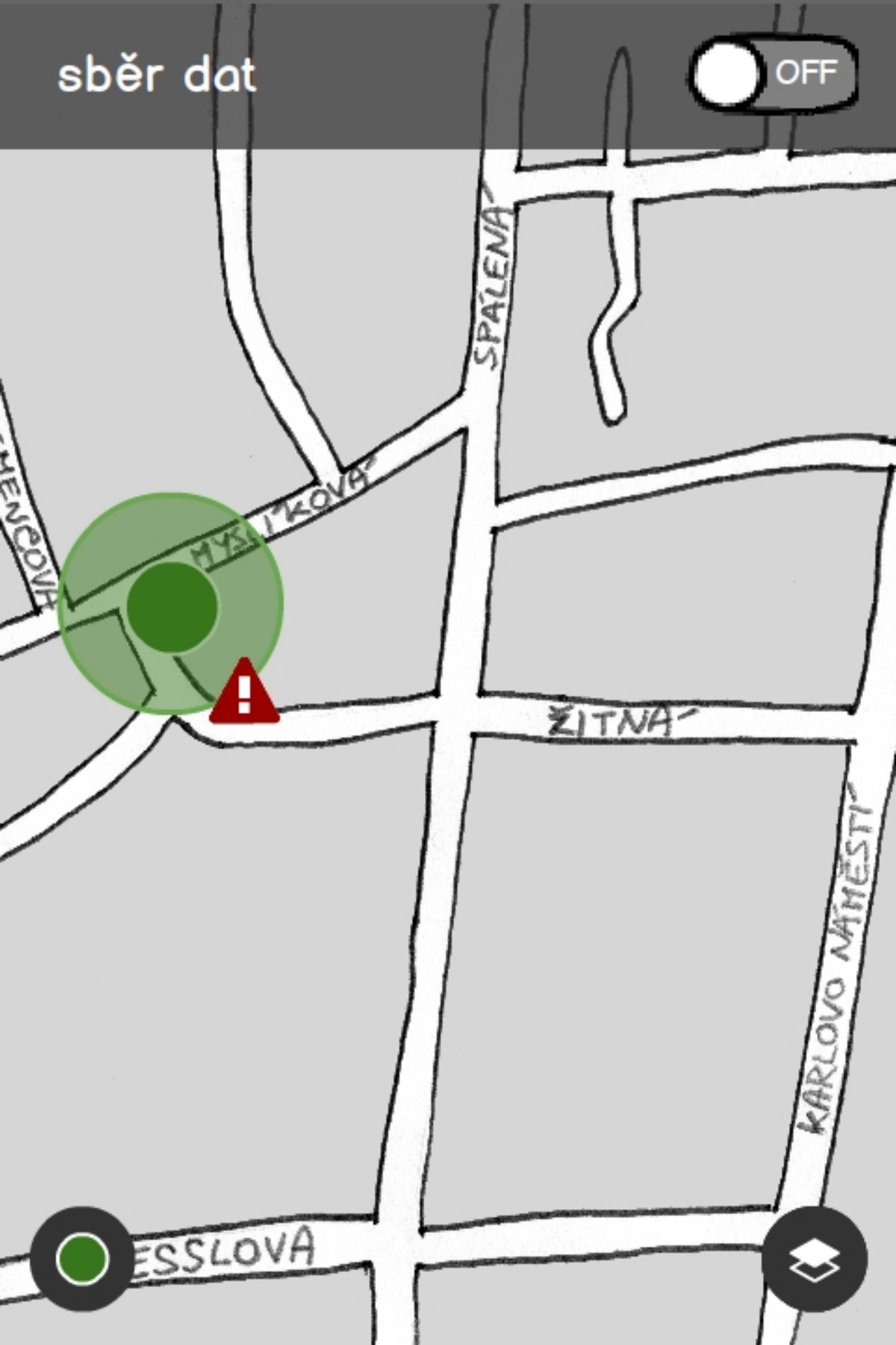

vyhledávání



hra



překážka





přechod



roh

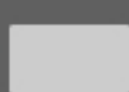

chodník

ON

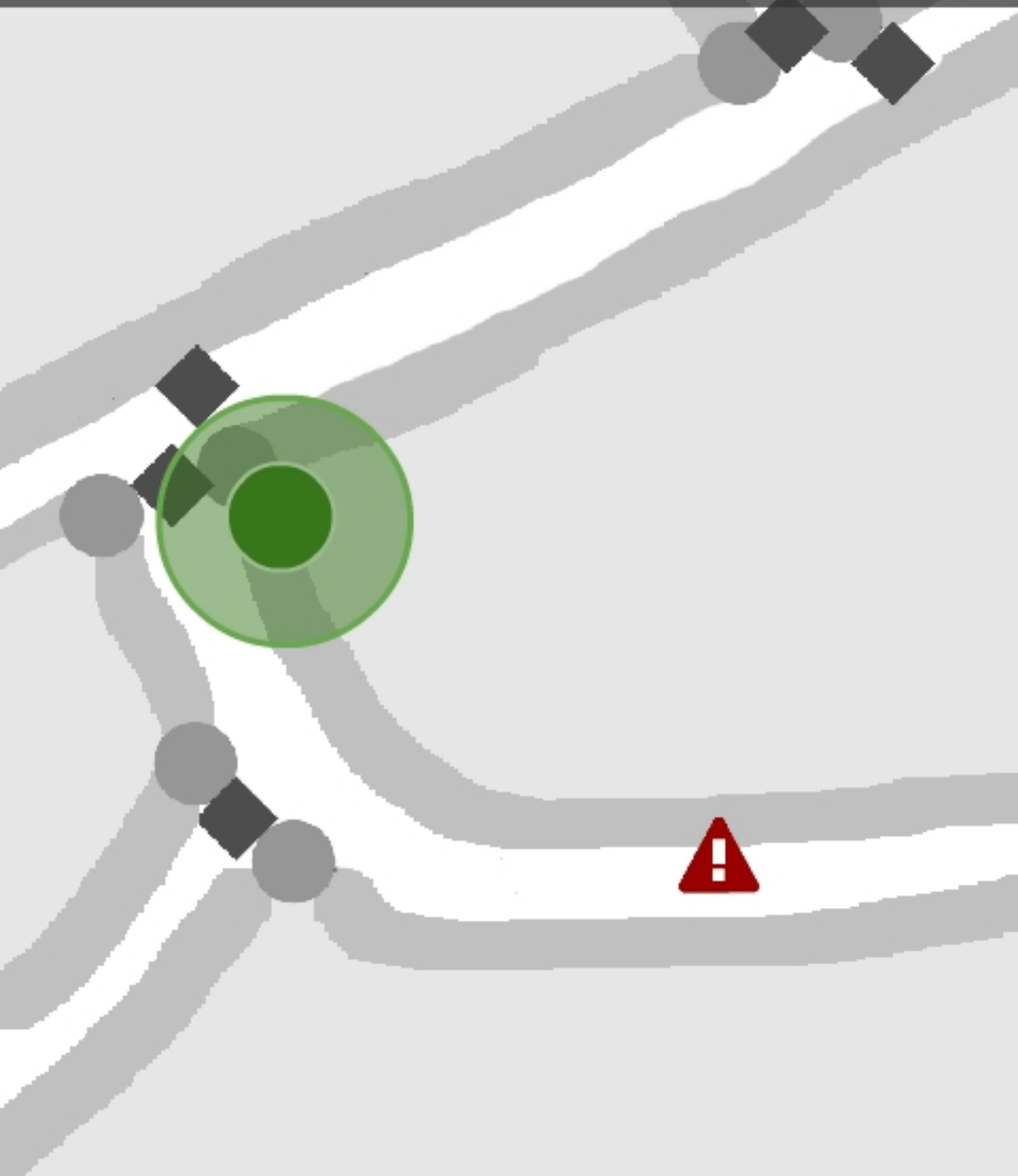

vyhledávání



hra



překážka





Vyberte část přechodu

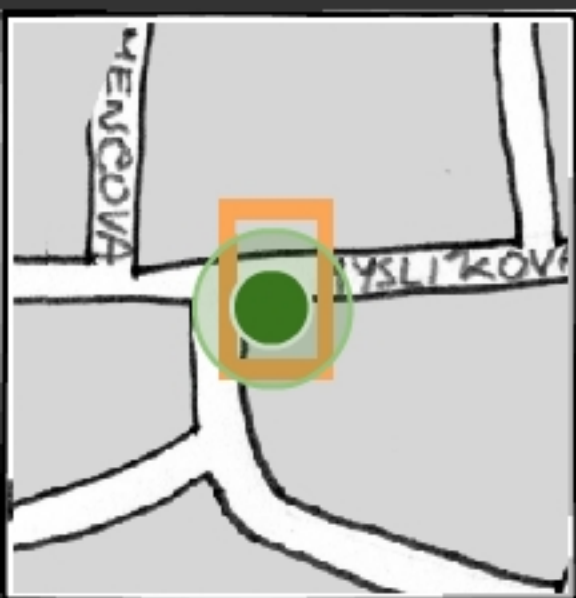

Pokračovat



Vyberte typ nájezdu

+2
body

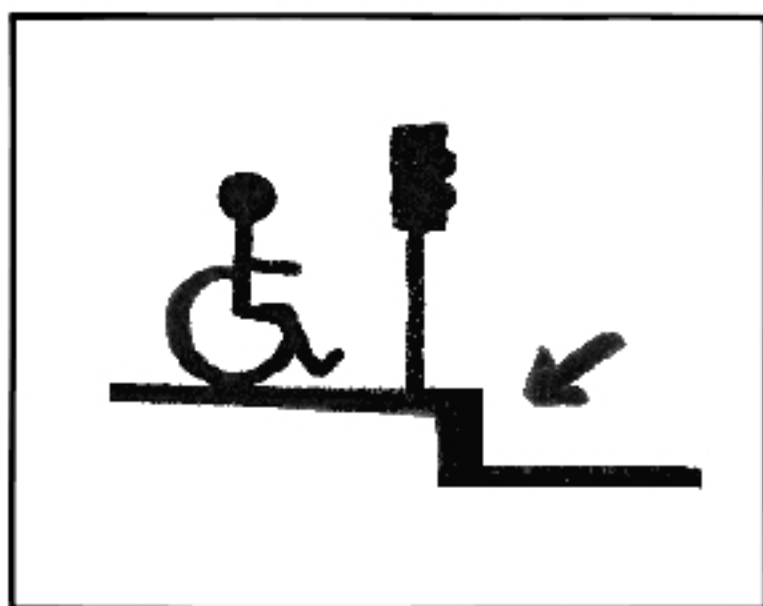
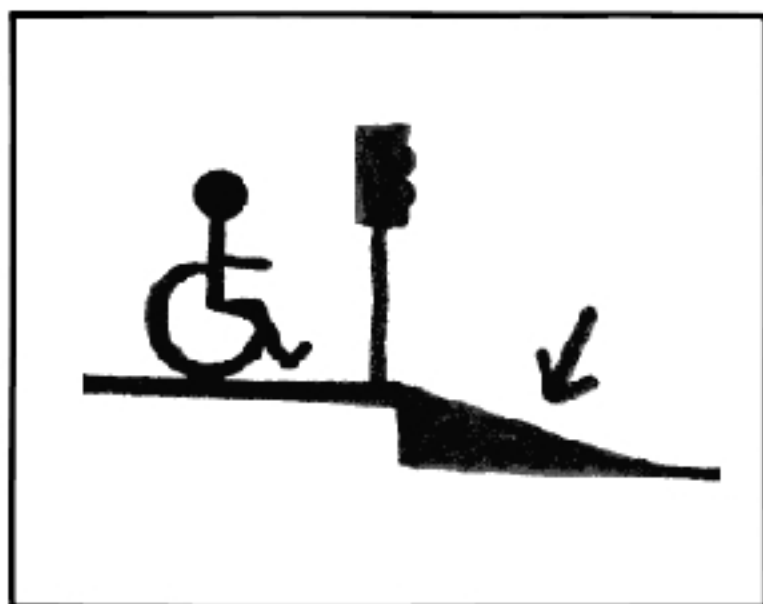

Pokračovat



Vyberte značení na nájezdové plošině

+2
body

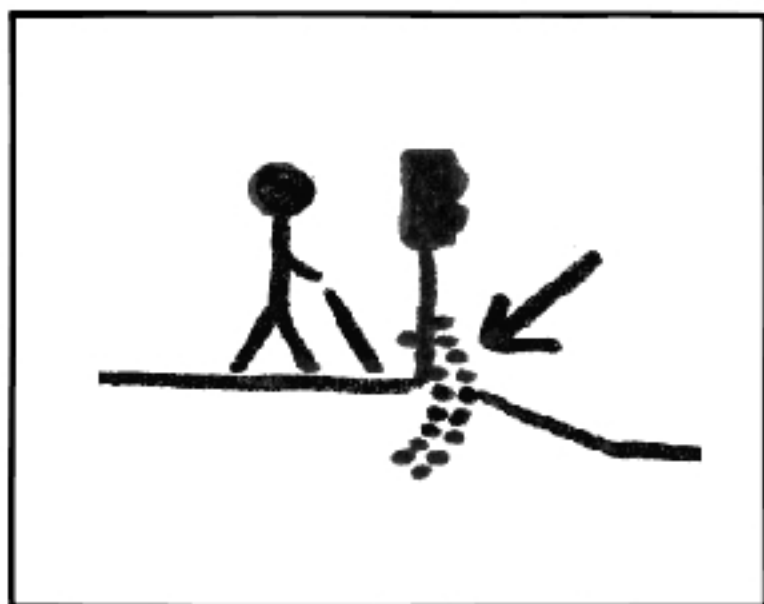
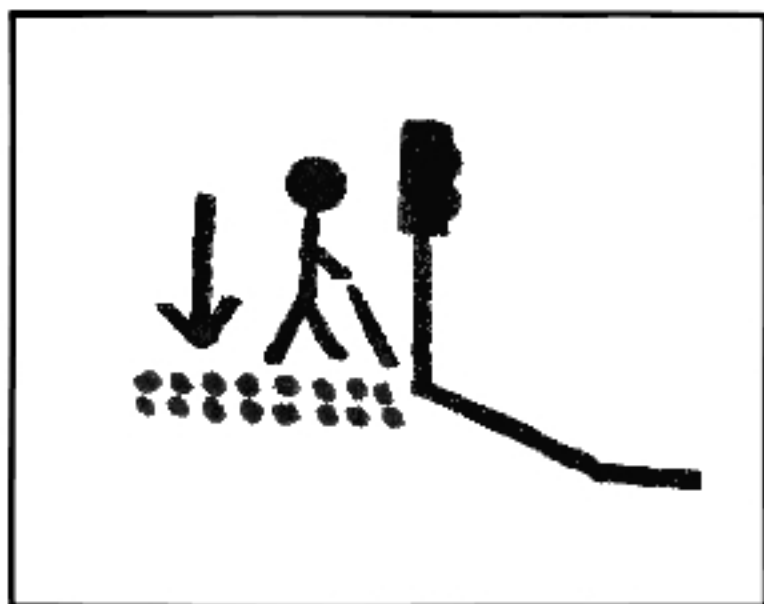

Vyberte žádnou, jednu nebo dvě možnosti.

Pokračovat



Má nájezdová plošina na
druhé straně přechodu
stejně vlastnoti jako aktuální
plošina?

NE

ANO



Zadejte výšku obrubníku

+5
bodů

Vyberte způsob měření

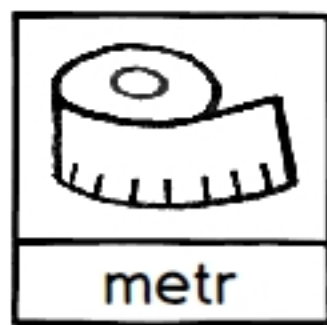

Vynechat

Pokračovat



Zadejte výšku obrubníku

+5
bodů

Vyberte způsob měření

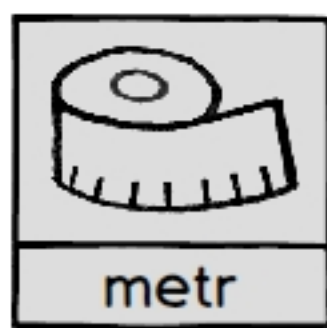

výška

cm ▼

Vynechat

Pokračovat



Zadejte výšku obrubníku

+5
bodů

Vyberte způsob měření

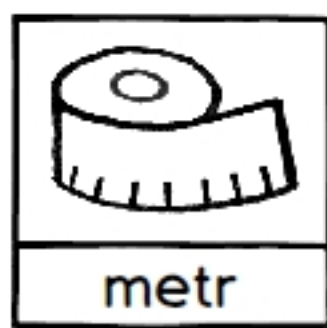

výška: ▼

Vynechat

Pokračovat



Zadejte výšku obrubníku

+5
bodů

Vyberte způsob měření

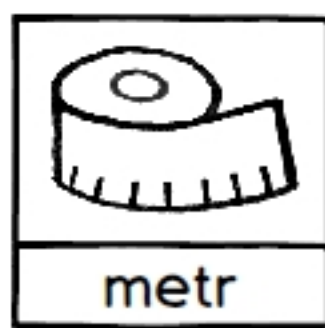

výška: ▼

Vynechat

Pokračovat



Vyberte typ a kvalitu povrchu nájezdové plošiny

+2
body



asfalt

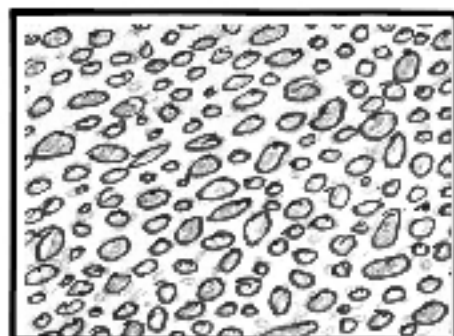

kamínky

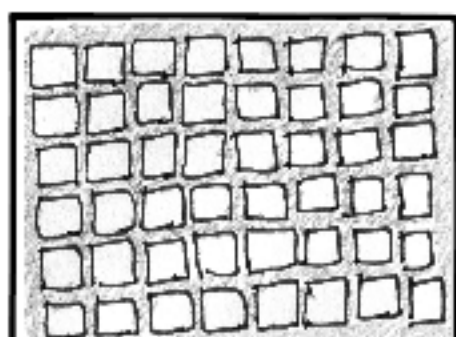

malé kostky

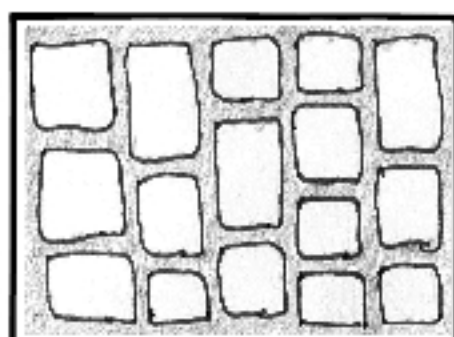

velké kostky

kvalita



Vynechat

Pokračovat



Vyberte typ přechodu

+1
bod

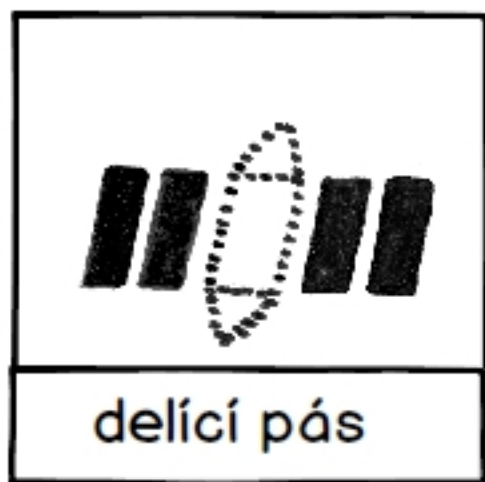
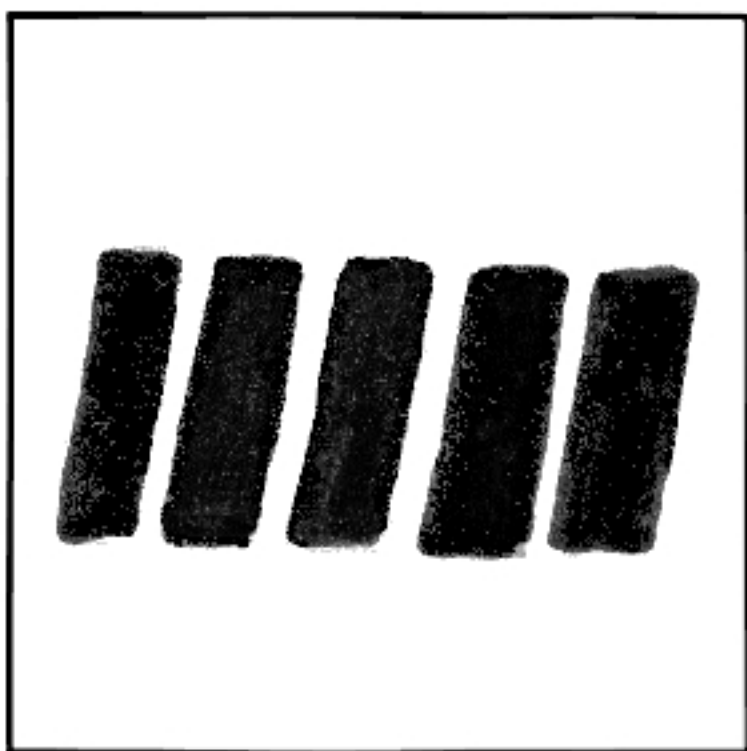

Pokračovat



Vyberte vlastnosti přechodu

+2
body

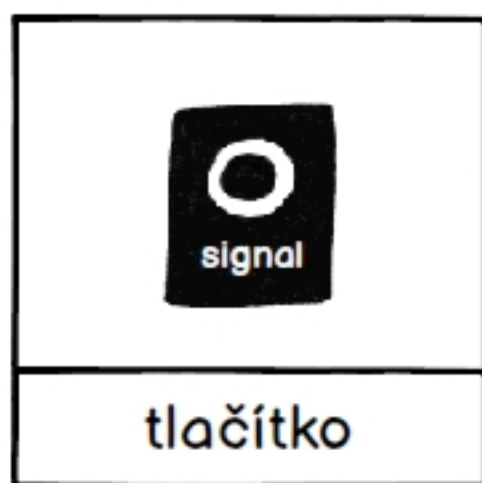
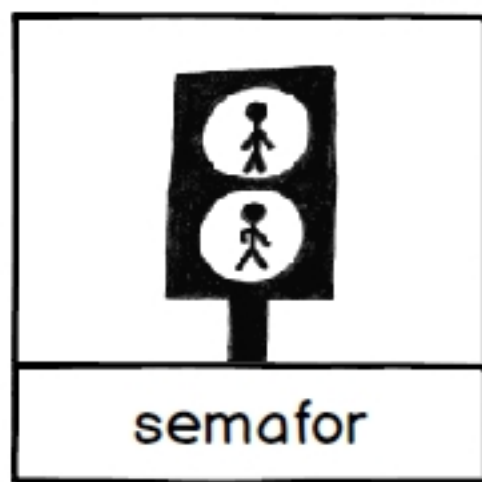
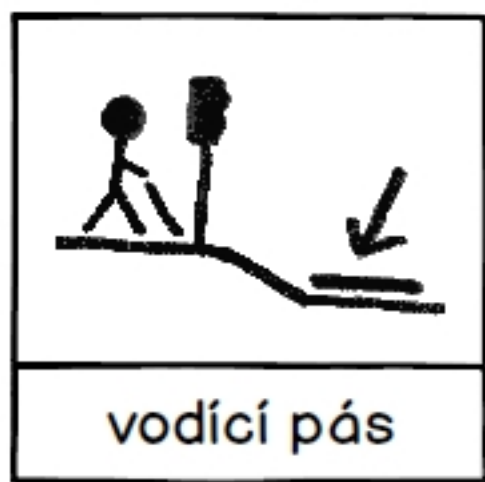

Zadejte počet jízdních pruhů

Vynechat

Pokračovat



Vyberte typ a kvalitu povrchu přechodu

+2
body



asfalt

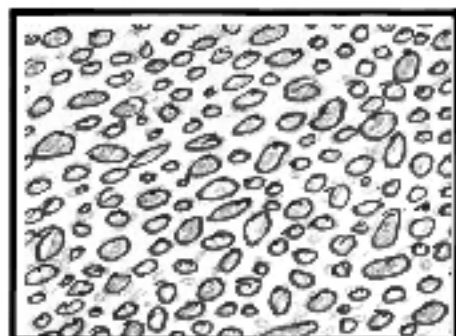

kamínky

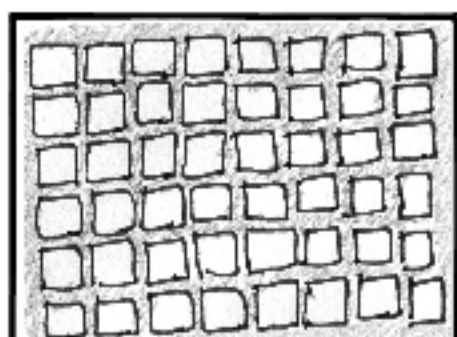

malé kostky

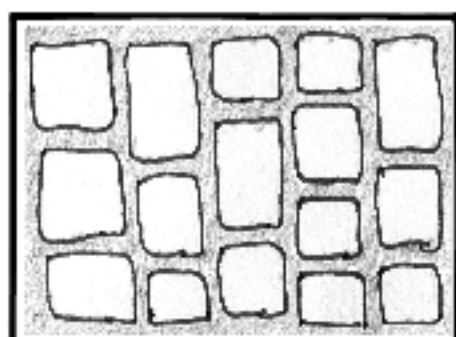

velké kostky

kvalita



Vynechat

Pokračovat



Zkontrolujte zadané informace o přechode



Typ nájazdu: bezbariérový

Přítomné značení :



Povrch: malé kostky

Kvalita povrchu: velmi dobrá



Typ přechodu: bez přerušení

Vlastnosti přechodu:



Počet jízdních pruhů: 1

Povrch: asfalt

Kvalita povrchu: velmi dobrá



Typ nájazdu: bezbariérový

Přítomné značení :



Povrch: malé kostky

Kvalita povrchu: velmi dobrá

Potvrdit



Dnes jste nahráli

31

bodů

a pomohli jste hendikepovaným lidem s bezpečnou navigací.

Děkujeme.

Sdílet

Pokračovat





průchod



roh



chodník

ON

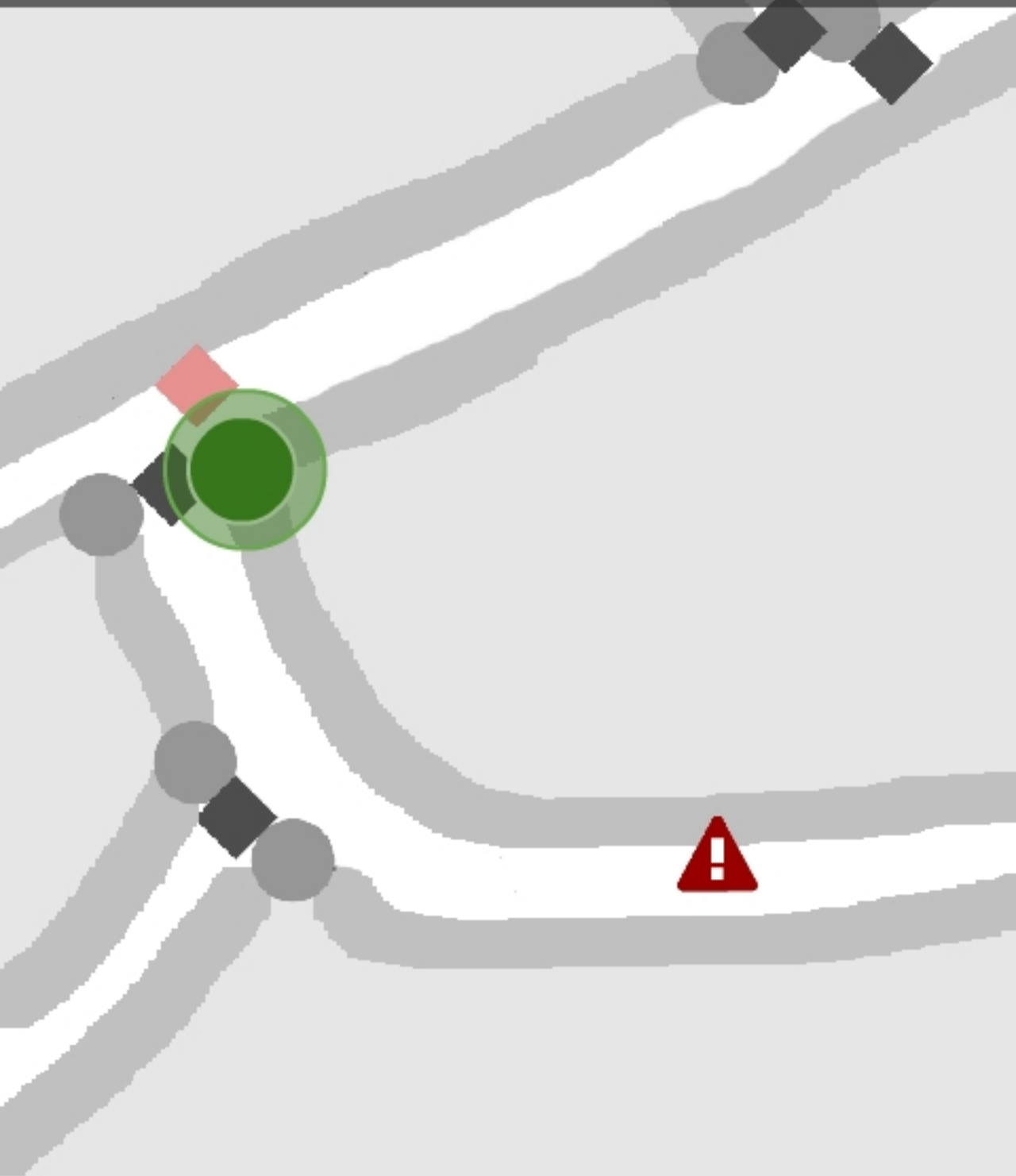

vyhledávání



hra



překážka





přechod



roh

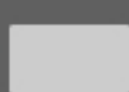

chodník

ON

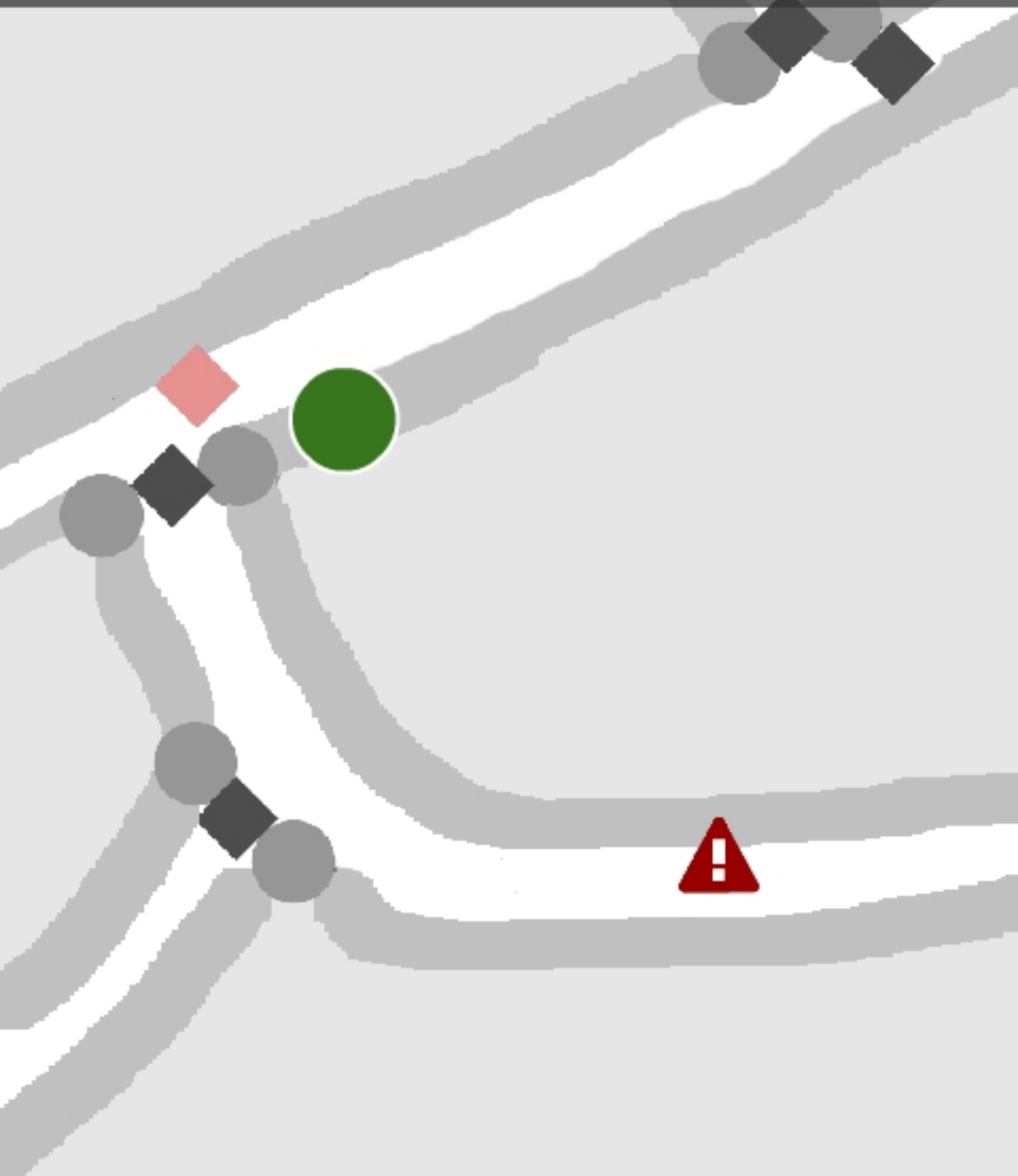

vyhledávání



hra



překážka





Vyberte tvar rohu

+2
body

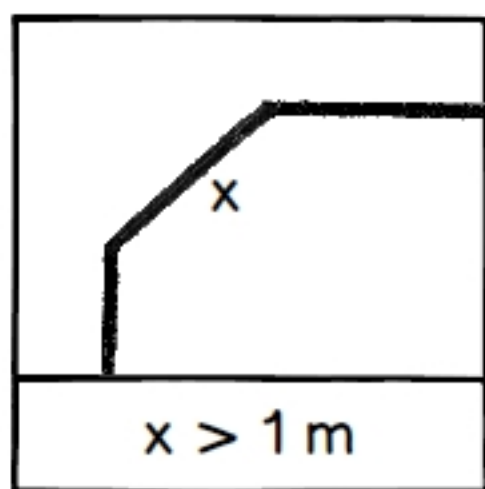
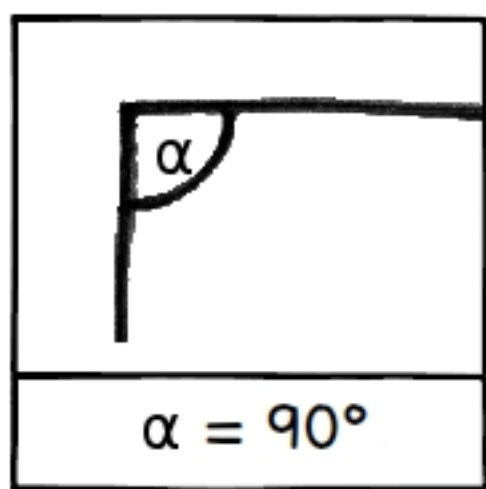
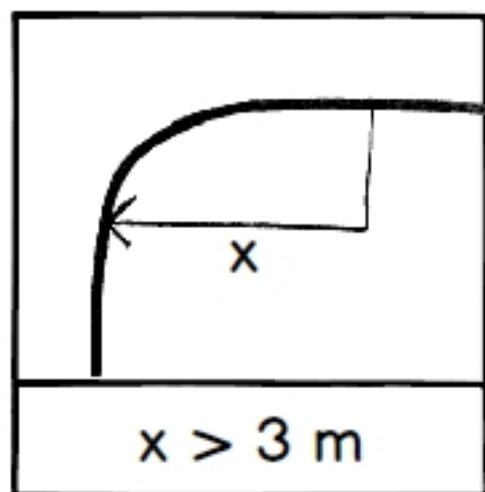
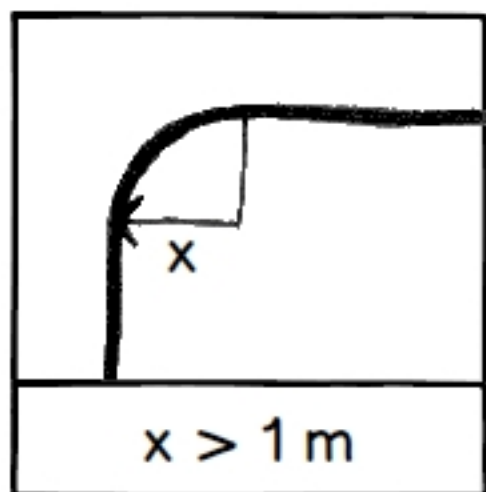

Potvrdit



Dnes jste nahráli

33

bodů

a pomohli jste hendikepovaným lidem s bezpečnou navigací.

Děkujeme.

Sdílet

Pokračovat





přechod



roh

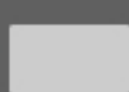

chodník

ON

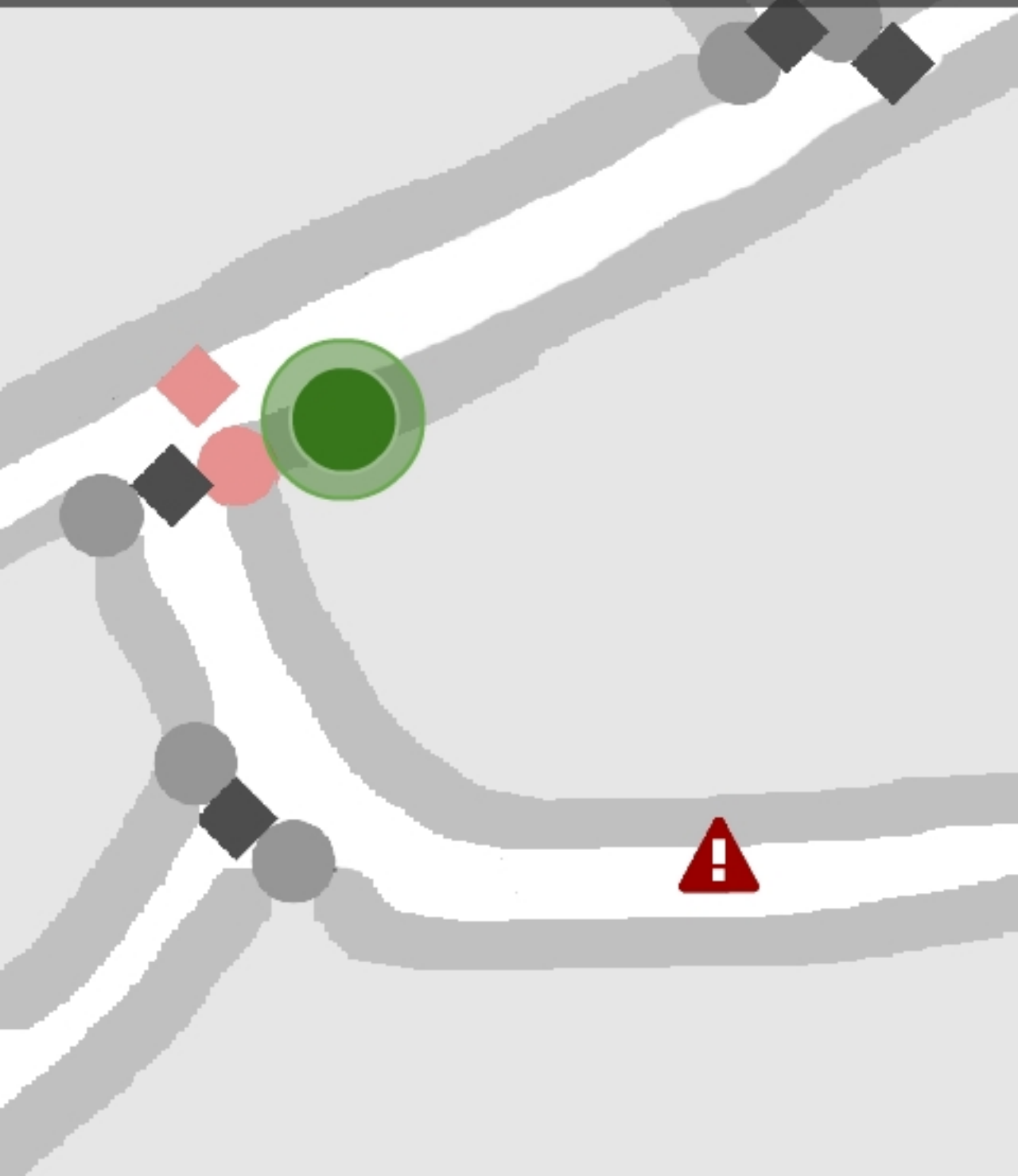

vyhledávání



hra



překážka





přechod



roh

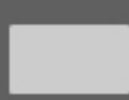

chodník

ON

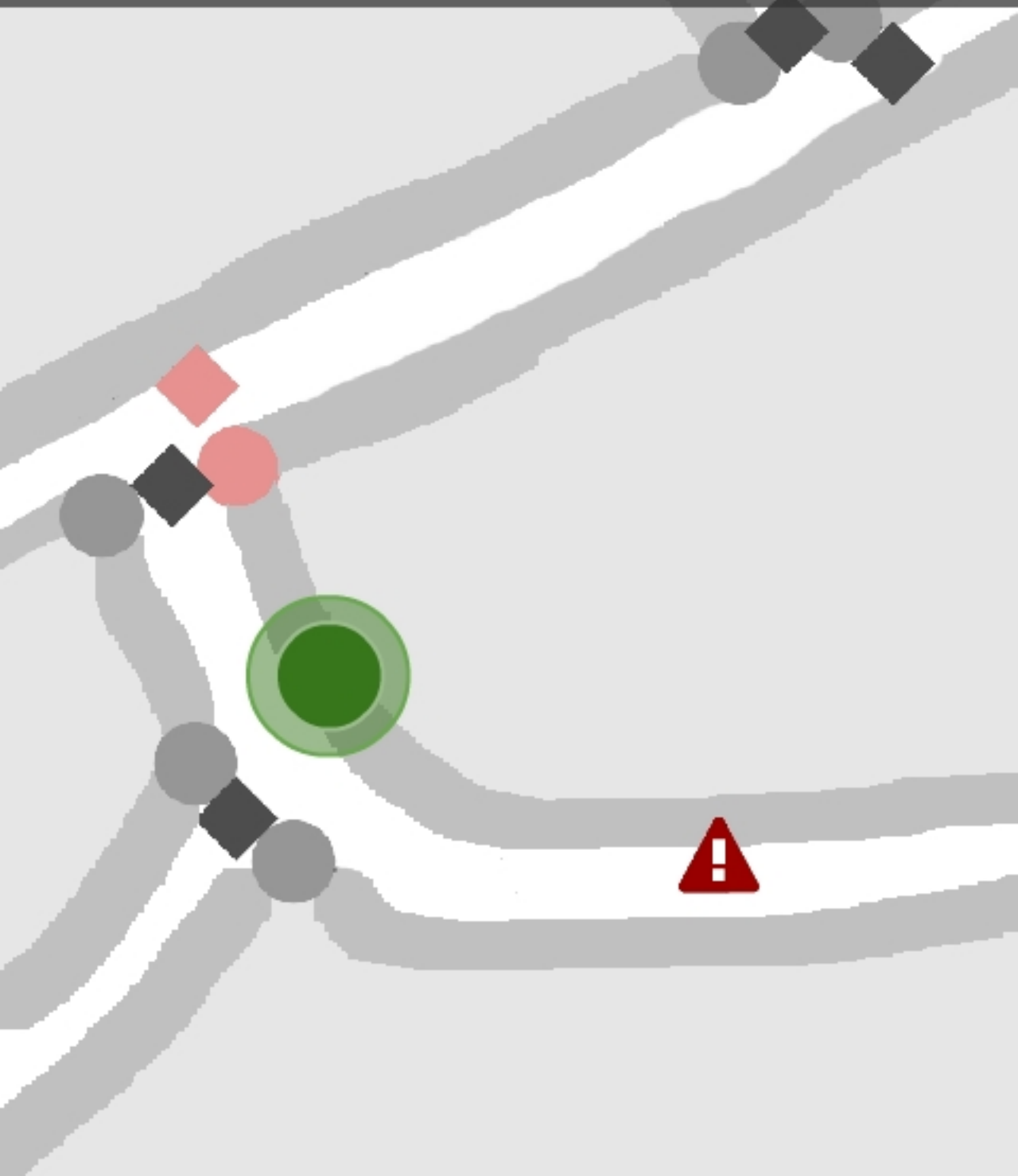

vyhledávání



hra



překážka





Zadejte šířku nejužšího
místa na chodníku

+5
bodů

Vyberte způsob měření

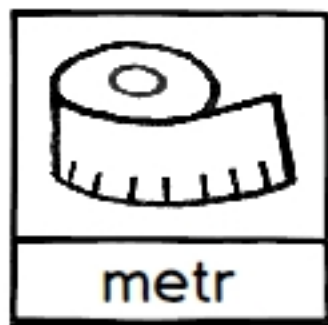

Pokračovat



Zadejte šířku nejužšího místa na chodníku

+5
bodů

Vyberte způsob měření

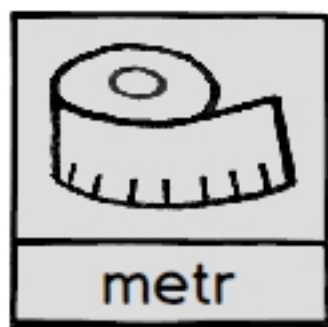

šířka:

cm ▼

Pokračovat



Zadejte šířku nejužšího místa na chodníku

+5
bodů

Vyberte způsob měření

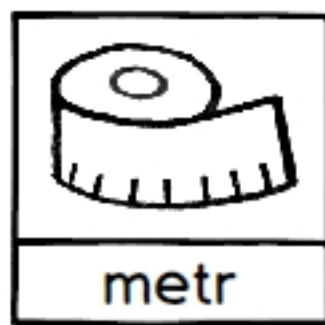

šířka: ▼

Pokračovat



Zadejte šířku nejužšího místa na chodníku

+5
bodů

Vyberte způsob měření

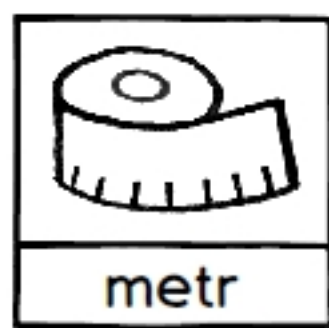

šířka: ▼

Pokračovat



Má chodník sklon? Vyberte typ sklonu

+2
body

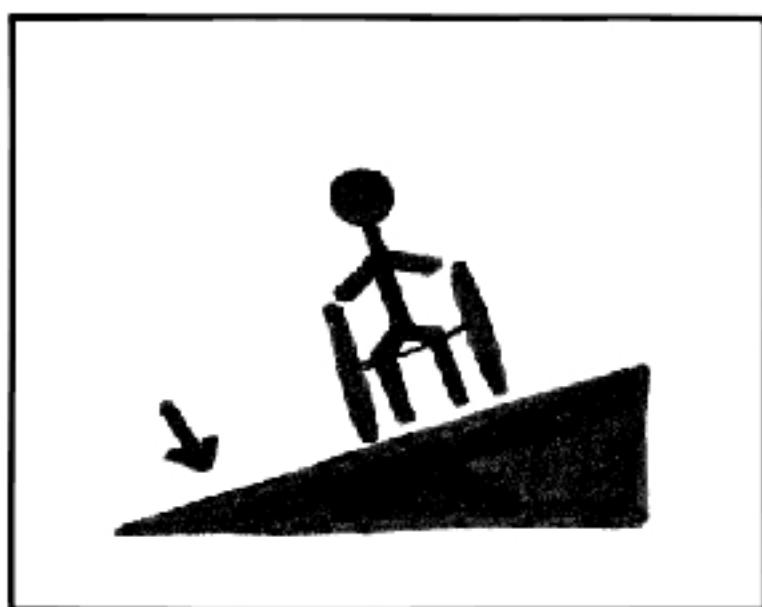
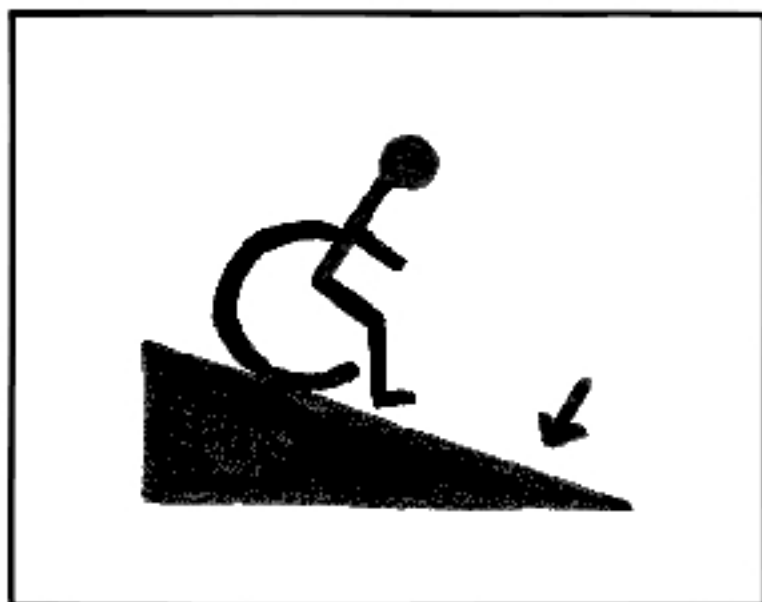

Vyberte žádnou, jednu nebo dvě možnosti.

Pokračovat



Vyberte velikost
přímého sklonu

+2
body

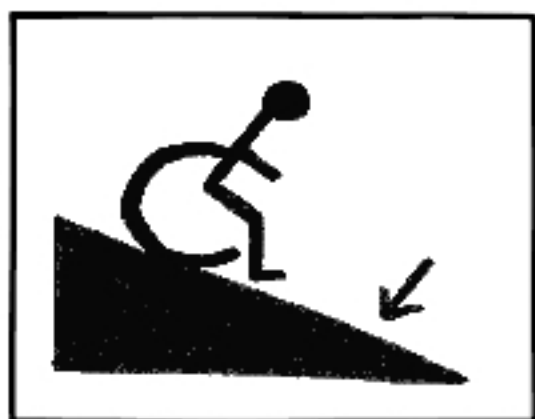
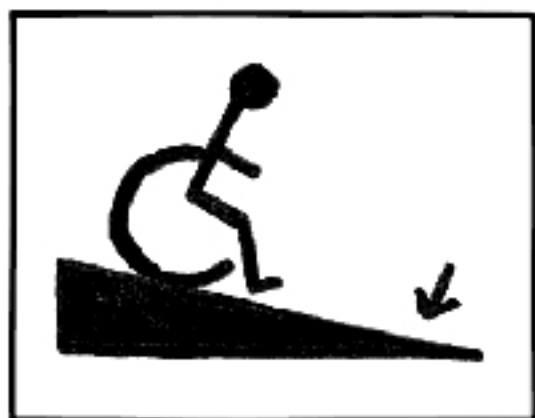
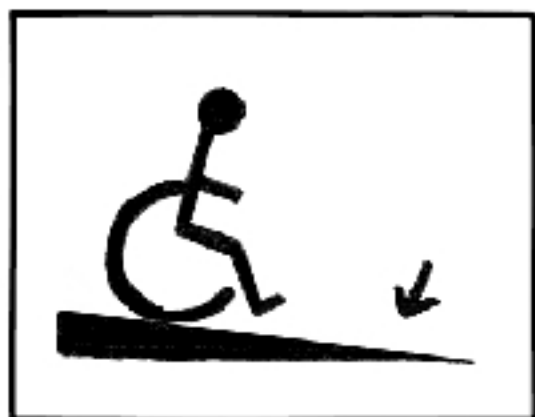

Pokračovat



Vyberte velikost
bočního sklonu

+2
body

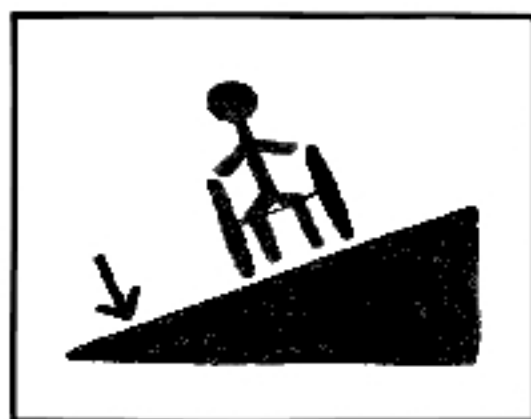
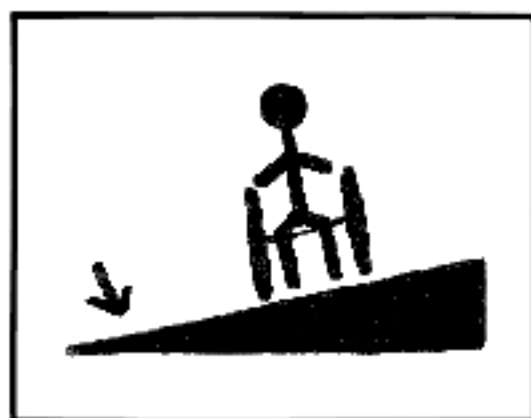
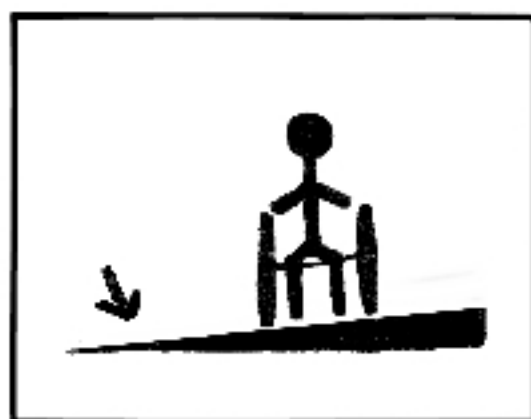

Pokračovat



Vyberte typ a kvalitu povrchu chodníku

+2
body



asfalt

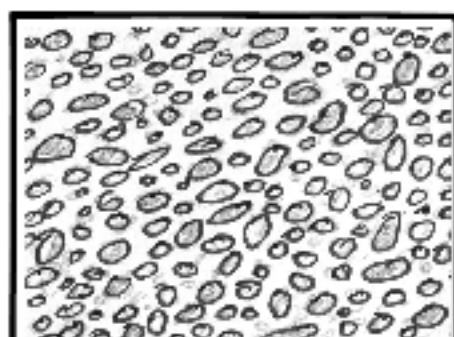

kamínky

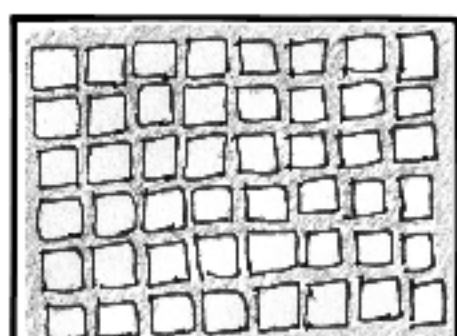

malé kostky

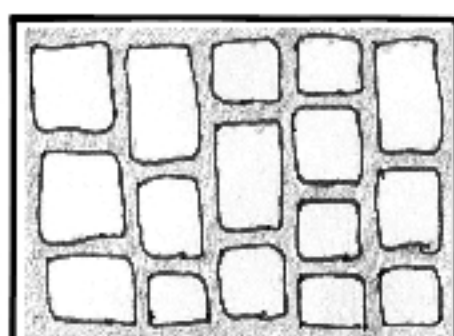

velké kostky

kvalita



Vynechat

Pokračovat



Označte okolí chodníku
ve směru jízdy
nejbližšího jízdního pruhu

+2
body

Napravo

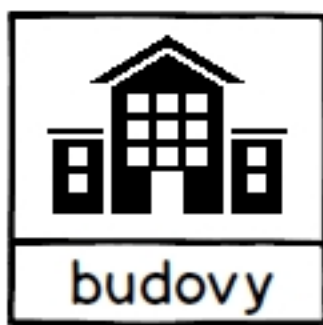

jiné

Nalevo



jiné

Vynechat

Pokračovat



Zkontrolujte zadané informace o chodníku

Šířka nejužšího místa: 1,2 m

Sklon:



střední



-

Povrch: malé kostky

Kvalita povrchu: dobrá

Okolí ve směru jízdy:



nalevo



napravo

Potvrdit



Dnes jste nahráli

46

bodů

a pomohli jste hendikepovaným lidem s bezpečnou navigací.

Děkujeme.

Sdílet

Pokračovat





přechod



roh

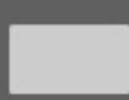

chodník

ON

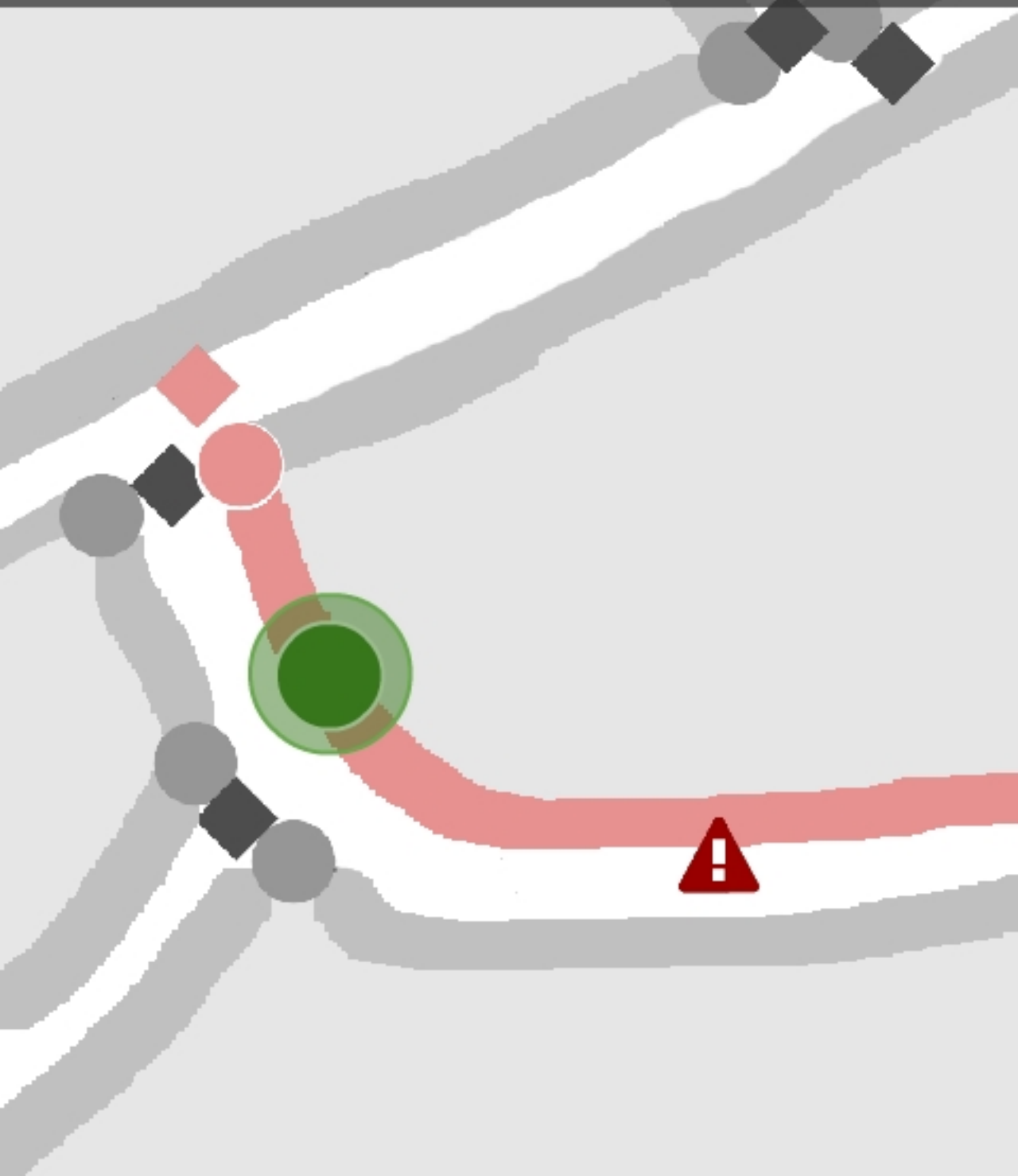

vyhledávání



hra



překážka





PROFIL

ODZNAKY



fero

body

25

114

důvěryhodnost



odznaky

2

žebříček

měsíční

roční

celkový

1.



maria
87 bodů

2.



petr
73 bodů



PROFIL

ODZNAKY

Aktuální výzva

3.1. - 31.3.2017



1 přechod + 1 roh + 1 překážka + 1 validace

začít



10 přechodů



20 překážek



10 rohů



PROFIL

ODZNAKY



fero

body

56

145

důvěryhodnost



odznaky

2

žebříček

měsíční

roční

celkový

1.



maria
87 bodů

2.



petr
73 bodů



PROFIL

ODZNAKY

Aktuální výzva

3.1. - 31.3.2017

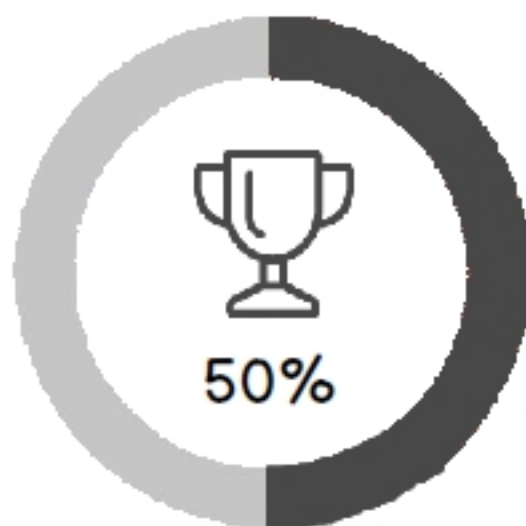

1 přechod + 1 roh + 1 překážka + 1 validace

[pokračovat](#)



10 přechodů



20 překážek



10 rohů



Zkontrolujte zadané informace o přechode



Typ nájazdu: bezbariérový

Přítomné značení :



Povrch: malé kostky

Kvalita povrchu: velmi dobrá

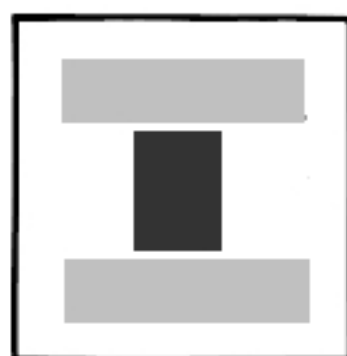

Typ přechodu: bez přerušení

Vlastnosti přechodu:



Počet jízdních pruhů: 1

Povrch: asfalt

Kvalita povrchu: velmi dobrá



Typ nájazdu: bezbariérový

Přítomné značení :



Povrch: malé kostky

Kvalita povrchu: velmi dobrá

Upravit

Potvrdit



Zvolte část přechodu, kterou chcete upravit



Typ nájazdu: bezbariérový

Přítomné značení :



Povrch: malé kostky

Kvalita povrchu: velmi dobrá



Typ přechodu: bez přerušení

Vlastnosti přechodu:



Počet jízdních pruhů: 1

Povrch: asfalt

Kvalita povrchu: velmi dobrá



Typ nájazdu: bezbariérový

Přítomné značení :



Povrch: malé kostky

Kvalita povrchu: velmi dobrá

Pokračovat



Zvolte informace,
které chcete upravit

Typ přechodu

Vlastnosti přechodu

Počet jízdních pruhů

Typ povrchu

Kvalita povrchu

Pokračovat



Zadejte počet
jízdních pruhů

+1
bod

Pokračovat



Dnes jste nahráli

47

bodů

a pomohli jste hendikepovaným lidem s bezpečnou navigací.

Děkujeme.

Sdílet

Pokračovat





Zkontrolujte zadané informace o přechode



Typ nájazdu: bezbariérový

Přítomné značení :



Povrch: malé kostky

Kvalita povrchu: velmi dobrá

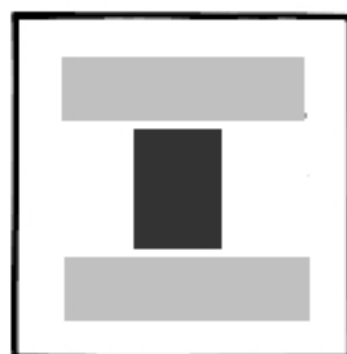

Typ přechodu: bez přerušení

Vlastnosti přechodu:



Počet jízdních pruhů: 2

Povrch: asfalt

Kvalita povrchu: velmi dobrá



Typ nájazdu: bezbariérový

Přítomné značení :



Povrch: malé kostky

Kvalita povrchu: velmi dobrá

Upravit

Potvrdit