

Czech Technical University in Prague

Masaryk Institute of Advanced Studies

and

University of Economics, Prague

Entrepreneurship and Commercial Engineering in Industry

Ing. Richard Pinka

Concept of cloud application for improvement the interactions of participants of the building development processes at the world building industry and manufacturing industry markets.

Master Thesis

CZECH TECHNICAL UNIVERSITY IN PRAGUE
MASARYK INSTITUTE OF ADVANCED STUDIES
and
UNIVERSITY OF ECONOMICS, PRAGUE

Thesis assignment

School year: 2014/2015

Name and surname: Richard Pinka

Study program: Entrepreneurship and Commercial Engineering in Industry

Field of study: Entrepreneurship and management in industry

Form of study: combined

Thesis assignment : *Concept of cloud application for improvement the interactions of participants of the building development processes at the world building industry and manufacturing industry markets.*

Principles for the thesis writing

Target of work (clear definition of the examined problem):

The target of the work is to create analysis and concept of extension of existing information system *Mondis* created at *Departement of Cybernetics, FEL, CTU*. This extended concept will be focused for contemporary building industry market and for supporting and streamlining its processes and cooperation of its participants.

Theoretical starting points:

Concept for extended information system will be joining areas of "demand and supply" of all participants joined at the building project processes at building industry market. This concept will be targeting the world building industry marketplace, from one part as free public service, from the second part as commercially payed B2B service, available to provide IT outsourced services for specific activities done on daily basis by individual participants of the building process. System will unify and integrate to one place the technology, manufacture, design, realisation, trade, maintenance, business, law, and least but not the last the financial area of the building industry development processes. The analysis and concept pre-design will be made on behalf of the exploration of opinions, outlooks and experiences of the building processes participants by selected methods of quantitative and qualitative surveys. Output of the thesis will be material for further development of business plan.

- UML language
- Rational Unified Process methods - RUP
- Survey of the building industry market
- Analysis of existing informational system
- Design of concept of the IS

Work methods:

- **Survey** – terrain survey of the selected participants of building processes representatives used by questionnaires (as quantitative method) and specific interviews (as qualitative method) the result of survey is to specify the demand of potential users of final systems
- **Analysis** of the survey, specification of most important and key processes, threats, opportunities, weak and strong factors
- **Detailed descriptions** – detailed descriptions of building processes participants working processes, descriptions of possible processes as BI commercial and non-commercial services
- **Design of concept** – final export is complete basic concept information system for working processes of all participants of building processes at building industry market

Framework of thesis:

- 1 Introduction
- 2 Inspiration for project
- 3 Used methods and tools
- 4 Analysis, possibilities and expansion availability
- 5 Design
- 6 Business plan
- 7 Conclusion
- 8 Used sources

Literature:

- [1] Molnár, Z. Podnikové informační systémy. 2. vydání. Česká technika - nakladatelství ČVUT, 2009. Praha, 195s. ISBN 978-80-01-04380-6.
- [2] Kanisová, H., Müller M.: UML srozumitelně, 2. aktualizované vydání. Computer Press, a.s., Holandská 8, Brno, 2007. ISBN 80-251-1083-4.
- [3] Arlow, J., Neudstadt I.: UML 2 a unifikovaný proces vývoje aplikací, 1. vydání. Computer Press, a.s., Holandská 8, Brno, 2008. ISBN 978-80-251-1503-9.
- [4] Svozilová, A.: Projektový management, 1. vydání. Nakladatelství GRADA, 2006, 353s. ISBN 80-247-1501-5.
- [5] Řepa, V.: Analýza a návrh informačních systémů. Ekopress, Praha 1999, ISBN: 80-86119-13-0. str. 17-19.
- [6] WIEGERS, K.E.: Požadavky na software: od zadání k architektuře aplikace. 1. vyd. Brno 2008, ISBN: 978-80-251-1877-1
- [7] Aundhe, M.D., and Mathew, S.K., Risks in offshore IT outsourcing: A service provider perspective, European Management Journal (2009), doi:10.1016/j.emj.2009.01.004
- [8] BRUCKNER, Tomáš; VOŘÍŠEK, Jiří. Outsourcing a jeho aplikace při řízení informačních systémů podniku. 1. Vyd. Praha: Ekopress, 1998. 119 str. ISBN: 8086119076
- [9] Yang, C. and Huang, J.-B.: A decision model for IS outsourcing, International Journal of Information Management, 2000, Vol. 20 No. 3, pp. 225-39

Thesis supervisor: Ing. Jiří Kaiser, Ph.D.

Supervisor signed : *Jiří Kaiser*

Date of assignment submission :

2.12.2014.

Date of thesis submission:

2.12.2014

Student signature accepting the thesis assignment :

Pávek Pávek

This assignment is valid three semesters in consecutive.

Acceptance of thesis assignment

4.3.2015 J. Imposny

Date and signature of head of study program

Jalova

Signature of director MIAS

Supervisor / Vedoucí diplomové práce:

Opponent / Oponent diplomové práce:

Defence date / Datum obhajoby:

Assessment / Hodnocení:

Prohlášení:

Prohlašuji, že jsem diplomovou práci zpracoval samostatně a že jsem uvedl všechny použité informační zdroje.

V Praze, datum

.....
podpis diplomanta

Acknowledgements

On the first point I want to thank to my dearest girlfriend Petra which gave me lot of support and enthusiasm during my work on the thesis.

I am very grateful for my supervisor's effort to help me to learn and discover new ranges out of my experience with mutual discussions and supportive attitude.

Finally, I need to thank to all of my friends whom I did continuously discuss the matter of solved work, to monument protector, again, my dearest Petra Ambrušová, urban architects Matej Kamenický and Iris Flamm, engineers Anna Osipova and Peter Tropko.

Identification record

Richard Pinka. *Concept of cloud application for improvement the interactions of participants of the building development processes at the world building industry and manufacturing industry markets*. Prague, 2016. Number of pages 137, number of attachment pages 9. Master thesis. Czech Technical University in Prague, Masaryk Institute of Advanced Studies and University of Economics, Prague, Entrepreneurship and Commercial Engineering in Industry. Ing. Jiří Kaiser, Ph.D.

Abstract

Construction industry has been gradually and progressively evolving over the centuries. Demand for the growth is certain and industry results are falling and raising with the ability to plan, construct and maintain construction projects according the technical laws. As new innovations are implemented to construction processes, all spectre of construction industry participants cannot reach demanded point of effective cost reasonable decisions and collaboration avoiding construction, finance and human losses. This master thesis proposes the basic concept of cloud application for the integration of construction and manufacture industries processes supporting functions in one whole integrated system able to processing the already existing IFC data for the purposes for satisfaction of the needs of all participants within construction process.

Keywords:

cloud application, work processes, effective work, ontology databases, Industrial Foundation Classes (IFC), building processes, construction processes, administrative processes, construction industry, manufacture industry, spatial planning, multi-scale planning, sustainable development, investment evaluation, multi-agent problem solving

TABLE OF CONTENTS

Abstract	1
My reasons for select a topic of my work	4
The point of focus : Building constructions and facilities	6
Specification of the troubles : troublemakers	8
Troublemakers determined by the survey	10
The aspect of “sustainable growth” and business discoveries in “non-profit” areas versus actual capitalistic view.....	14
Methods and ways for conceptual solving - troublesolvers	16
Content description and scope of the work	17
The scope of methodology and conceptual work	20
Multiple spectacle to same case	20
Conceptual point of view.....	20
Economic point of view	21
Idea of the information system	24
What actually is BIM ?	24
IFC - industry foundation classes.....	25
Relation of scope of my work with BIM and IFC : Smarter Ways for Working.....	26
IFC information model description.....	27
5.1.2.44 IfcRoot	28
IfcPropertySet – the exemple of the most used IFC attribute	30
Enumeration identifier example (attributes)	30
Used methods and tools for software development	32
UML and RUP methodology	32
Analysis, possibilities and expansion availability	36
Mondis project - my motivation and its basic analysis	36
Chapters of Practical work	39
Informations and its management	39
Focus to functionalities for Designing phase - Designer Actor role functionalities Description	40
Drafting the concept of cloud application.....	44
For whom shall be IS for ?.....	44
Application requirements.....	45

Further requirements	47
Future changing and enhancing the system possibilities	47
Interface of system.....	47
Safety	48
Actor roles division.....	48
Activities and Activity Scenarios of users	48
General Actor (G).....	49
Investor (I)	89
Designer (D).....	91
Authority (A).....	105
Controller (Con).....	113
Contractor (Ctr), Subcontractor (Sctr).....	113
Supplier / Industrial manufacturer (S/M).....	115
Operator (O)	119
Object User - tenant (U)	126
Administrator (Ad).....	129
Agent solver (Ag)	130
Requirements for system.....	134
Project's potential : Business plan.....	135
Involve the lay society	135
Social profit for governments.....	135
Conclusion and Outlook	136
Tables	145

Preface

My reasons for select a topic of my work

My thesis is the result of logical consequences in my professional life which led me to create more exact concepts of solutions solving the problems which I did encounter during my professional work in the branch of construction industry. Impulses of my work intention I discovered in actual state of the construction market world-wide which is smoothly indicating demand for specific change in the matter of informations integrations and their transferring efficiency. Circumstances, situations and problems around my working duties has led and inspired me to create such theme for solving the most known difficulties which I simply dislike during my work. And as I soon encountered I was not in these assumptions alone. In an international corporation who is technology manufacturer of HVAC systems selling them to the industry and civil engineering projects over world I began to prepare matter of thesis, which has been on the beginning of 2013.

My work inspiration which was born during my job where I was just a small piece of big machine working for its own purpose. Price strategy and “fighting” on market with the help technical advantages were and still are two main weapons on which the corporation, I used to work for, relies. These two weapons have been unfortunately during my work-time for the company used with high ineffectivity in internal work processes of employees aimed to prepare technical and price quotations for clients, which I was doing also. Frankly, as I heard recently, company has actually even more troubles after implementation of “unified” accounting system in the EMEIA sector which brought huge time delays and problems in accounting processes in the sector departments. The reason is such simple the Top management forget to consider it : local european countries accounting accounting differences required by law. This gave me the conclusion that even a big well prepared idea could crash at the troubles nobody expected. My second inspiration for this work was my first master thesis. My aim was to evaluate the best facade areas for the solar air collector installation taking into account the shading of surrounding buildings and to evaluate the best technical alternative of the solar air collector by using CFD simulation on more than 4 variants of 3D models of air collectors. Both of these activities led to final solar air system connected to the internal ventilation system with the final evaluation of the influence to the building energetic balance as a whole. Design process consisting from three types of simulations: solar shading, CFD, building energy simulation on the beginning of the design i assumed as fast and easy but was not. This kind of design I today consider as a scout type because of its non-proved results on real installations and high costs for the length and unnecessary during design. That means high risk. Lot of slow data input to simulation softwares, lot of continual and repeating breakdowns of simulations leads me to true conclusion : this is really not effective way to produce value.

Going back to my theme, big fragmentation of applications and softwares used by employees for the selection of industrial products supplied to construction project hand in hand with their pricing policy and proposals is huge problem causing internal labour force productivity inefficiency. It is simply not “All-in-one” solution. If you consider the fact that this process is repeated many times per day, per week, per month, per year and this activities are main aim of many engineering workplaces in the construction industry, the necessity for improving this state is serious. Lowering work-times for the quotation can have gross impact to improving the frequency of participation at the market demand with more proposals. This is only one point of view from the position of *Supplier (or manufacturer)* but there are more view standpoints which could change a whole market and move it little bit closer to the so called *perfect concurrence market* according the philosophy of economy.

I see new potentials in work efficiency potential improvement during process of urban and industrial development in the building industry branch. But is this development sustainable ? How can I know?

My work’s concept will focus to description of implementation of new approach to data and its implementation with conclusions mentioned above to transformation to a new tools participants of construction and manufacture industry could use.

My work is based on three main assumptions which I will neither confirm or disprove on thesis end because outweigh scope of my work :

- According to my experience, too much of planning processes in construction industry are ineffective and gross potential for their improvements exists.
- Utilitarian social welfare maximization of business subjects is mostly in the scope commercial point of view - gaining the highest profit and their selected strategies negatively influences the welfare maximization of other subjects involved.
- When the economic subjects will become to use tools for effective planning and business activities taking into account the non-commercial scope during business activities evaluating, the decision strategies of all subjects will obtain possibility to react for the *mutual* welfare maximization of all involved subjects in the compliance of *Nash equilibrium*.

Note: mentioned subject having activities in construction and urban development.

The following hypotheses are to be verified in my thesis work :

- I. concept of cloud application can include description of all existing processes in construction industry and between participants of building project
- II. concept can describe solutions solving the “bad aspects”
- III. concept able to achieve data inputs from lay people based on the “free market philosophy” can be useful for decision making process in spatial design and building design

Nevertheless, if I would have to set specific long-term hypotheses which for evaluating their validity on the end of the project would be realised on behalf of this work in the future, it would be :

1/ Most of the needs of the construction processes participants related with the work efficiency would gain benefit from the utilization of cloud application constructed according this concept

2/ Decisions made based on this *intangible* construct called today as software (or cloud application) as a product of the construction planning processes improvements evolution, would be recognised by the interdiscipline *Theory of games and economic behaviour* [15] as known facts and would be led according *Nash equilibrium*[4] principle.

But these long term hypotheses can be evaluated sooner than system is running few years fully operational worldwide.

Introduction

The point of focus : Building constructions and facilities

The product of construction industry is building or civil engineering structure such as road, highway railway or industrial building such as car production plant. Construction industry products - buildings are caused by and are causing the main aggregate demand of trade, as investments of the private capital or public sector capital. This demand is created by the basic needs of either private sector : aim to grow and reach the profit or the public sector : arrange all necessary needs for raising the “common good” in society. Private sector is represented by local or international companies and public sector is represented by governments, non-government non-profit organisations.

According my point of view, the demand which is finally involved in decisions influenced the activity of construction industry is not created in compliance with philosophy of “Sustainable development”. Decisions of business activities of microeconomy subjects are based on multiple marketing, financial and strategy decisions, influenced by, again, financial circumstances right at the place of the future business. Economic key indicators for business subjects such as PEST (political, economic, social, technology factors) analysis, country economy evaluation - GDP, GDP per capita, purchasing power of country for product placement, BCG and BSC matrixes, etc. are taking into account today as main and only priorities for business deployment at the new market areas.

By the other words as an example, potential private equity business company - car manufacturer will barely build a car production plant in country, where could have employ definitely very motivated personnel as employees but country does not have good access to cheap material sources, proper infrastructure, hospitals, and good level of education system of population since childhood which definitely would have increased the company's expenses to impossible to realize. Conclusion from this example is the priority of the capital and profit priorities decided during the investment possibilities evaluation. The economic turning point of business is far away in future, if there is any. The owner of shares is interested to gain profits by dividends. Not to give it. If each car manufacturer would decide to move into such business environment, car prices would exponentially grow. As Smith wrote, "*The necessities of life occasion the great expense of the poor. They find it difficult to get food, and the greater part of their little revenue is spent in getting it.*" [1] , gave me the conclusion, that neither application of grand business project nor doing any development activity in described type of country will bring measurable utility maximization of the local society. Circumstances give almost zero chance to increase manufacturing sector in country giving chance to population not spend its all revenues for only the food and living and pushes *Lewis turning point* [2] [3] which would increase population's standards of living far away into the uncertainty. Thus there will be no large savings of labor who stays working only in local agricultural sector which leads to small further investments again and repeat this poor-country never ending circle. There would be place for growth which is not exploited and will hardly be. Than the developing countries, if they have any other potential than agriculture, can have as an trading attribute raw materials, which is, as well known fact, the source of civil wars or ethnic conflicts illegally supported by international corporates and conglomerates, like seen in Congo or Sudan conflict troubles. Where is international business law ? Nowhere. It simply does not exist in effective executive form.

Simply, right economic decisions shall be broader more than boarder of traditional economic point of view .

note: Sir W. Arthur Lewis was an economist who gained price of Swedish national bank for development of economy science for the memory of Alfred Nobel (Nobel prize) with Theodor Schultz in 1979 for "*their pioneering research into economic development research with particular consideration of the problems of developing countries.*" and gained Nobel prize which is different than peace prize.

Construction industry production is producing residential and non residential buildings, constructions of civil engineering works (e.g. railways, roads, bridges, airport runways and airports, dams) in value of billions USD worldwide quarterly. But can be the information "value of xx USD" mention something significant ?

How much does cost the m³ of family or administrative house 30 km far away from New York or Barcelona ? That is the "*actual investment costs*" question.

How much will you spend for cooling, heating and ventilation for these one cubic meter per each year over the next ten years ? That is the “*long-term operating costs*” question.

It is important to know distinguish these two types of costs and more crucial is to involve the difference it in the decisionmaking.

Economic decisions and rational economic shall be not deaf to the signals - price values on the market, just remember the situation of “ghost cities” or so called *under-occupied cities* (not only) in China[29], which are result of short-time boosting the GDP by local officials by fast selling the rural areas for developers who fast building of housing. No other country has built so many buildings, bridges, roads or airports as quickly as China did. Again, it was the short-time period point of economic view. Construction sector did its work, did its quest. But why for ? For no sense. Western way of country development and urbanisation was missing. Purchasing power of possible buyers and owners-investors is missing. Today, China’s birth policy has abandoned the “one child” policy for boosting the economy growth.

Specification of the troubles : troublemakers

In the history of mankind creative and manufacture work effort, born during the industrial era in 18th century, was project thus manufacture management still developing. According theory of *iron triangle of management* or simply *project management triangle* *time + costs + quality* is possible to prefer only two of them.

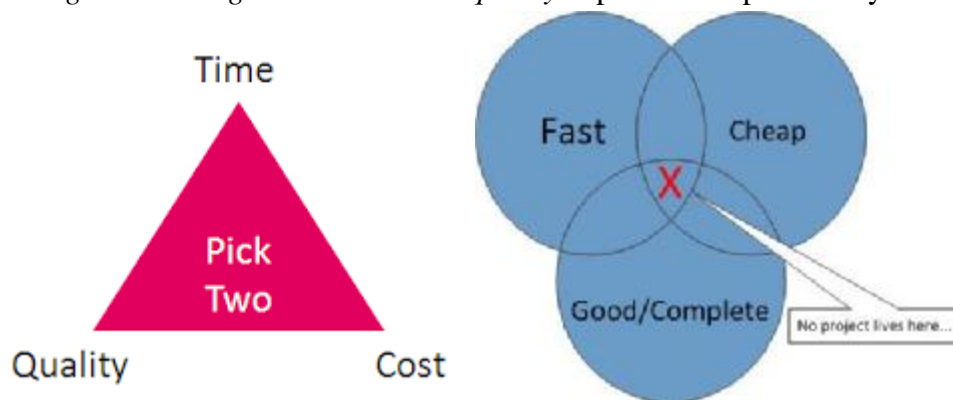

Figure G.3,G.4 : Iron triangle of management , source: [30]

Whenever You focus on one from the three attributes for try to improve it, You will have neglect the other two. During the ages are these three properties always improving and increasing their potential - i.e. with industrial age whether the time of manufacturing was highly reduced as well as the quality of work was slowly moving up. Costs were struggling and then slowly move down when the market demand rapidly increased. As the time flows, costs, time and quality of processes are slightly moving to reach the 100 % of perfectioness of each of them but it will never reach it because of the logic. There will be still “potential” to grow each from three aspects a little more. It is

the result of ability of implementation of new processes into the practice. These improvements leads basically to increase competitiveness abilities of the countries and leads to boosting their economy by increasing GDP grow, GDP, thus GNP.

Nowadays, in the point of view of fulfilling the possible potential with new technologies, I see the situation similar like in the pre-industrial times, in the manner of subjective point of view to this topic. Potential of informational technologies haven't done their big step till today on its full capacity yet, even they are trying.

No actual workflow effectivity which is used today is desirable forever, even if it is very progressive in comparison with the processes which are today already phased out.

From the macroeconomic point of view I specify more exact, local and microeconomic aspect of troublemakers. I cannot specify macroeconomic troublemakers which is out of the scope of my work.

Most important troublemakers are :

- **wrong decisions**
 - caused by wrong priorities set (priorities)
 - caused by wrong input informations (informations)
 - caused by correct informations but received too late (time)
- **absence of control of processes**
 - caused by lack of information or labour resources

consequences :

wrong design

- prolonging construction phase - time waste
 - having negative impact on long-term operation costs

wrong installation, construction and operation works

- increasing project costs by incompetent and unauthorised acting on site

Decisions mistaken meant during over the conceptual, design period as well as during the tendering the correct technology or material.

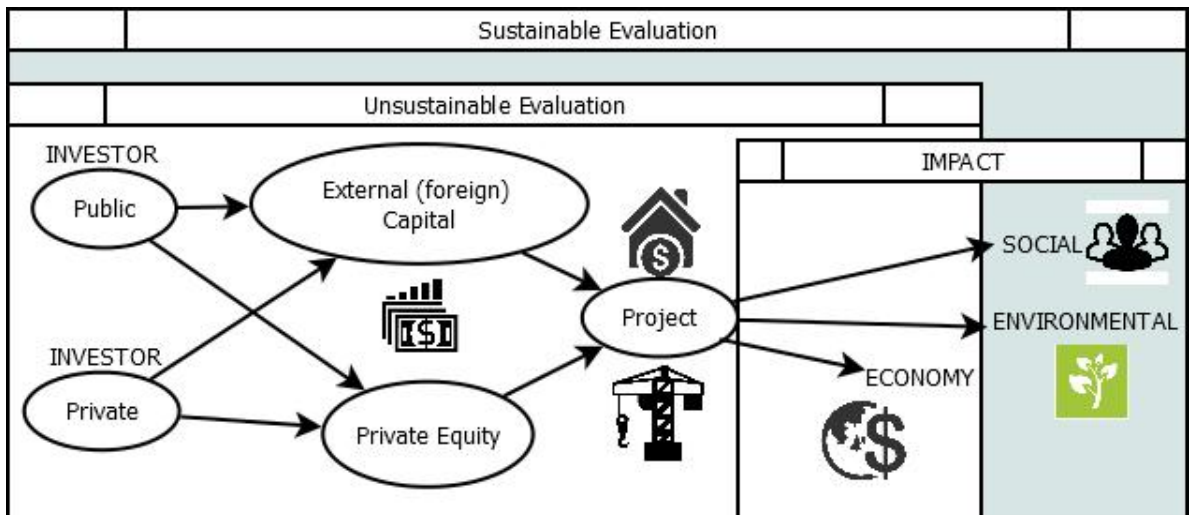

Figure G.9 : Impact of Evaluation of project on the sustainability, source: Diaportable design

In Figure G.9 you may see my point of view to the difference between sustainable and unsustainable development (thus evaluation). Difference consists on the profit requiring business subjects (ergo shareholders) which aim to be active only in these business activities, which shows some profit for them (white square area). Frankly, short term evaluation does not consider long-range effects on the activity surrounding. Who will pay off the increased value of gray water leakage, industrial waste stowage, or possible dangerous chemicals leakage (in the case of specific business industrial plan) after some decades ? This is externality impacting the social and environmental aspect of the same business activity. Shareholders are far away with their dividends raised. Crucial aspect is to change decision processes leading to unsustainable development and connect them with the long-range impacts.

Troublemakers determined by the survey

The Survey of actual construction process participants has been prepared and sent for filling it. Questions focused to determine and specify work processes inefficiencies were prepared right to fit each important roles - investor, designer, contractor, industrial manufacturer, authority official and building operator.

Even to unfortunately relatively small amount of respondent answers next conclusions I did achieve :

Week working time division (time volume dimension):

Respondents had divide 40 hours to specific types of the work : meetings, traveling, communication, coordination, drawing, search documents, study documents, numerical computations or other

Designer

time dimension :

The biggest volume of week working hours (standard $5 \times 8 = 40$ hours) are designers investing to their drawing design - drawing in commercial drawing software from 43 % to 51 % of the total amount of the week time, then were more important activities numerical computations (only in structural engineering this was on first place) communication (email + phone), coordination and document searching with their studying (searching and materials studying would be together on the 2nd place with its 10+8 percents average values).

Investor

time dimension :

Different values have been visible in the investor's role. Design drawing roles fall down to almost 0 % , meeting time has raised to 17 - 26 % value, coordination, cooperation and communication as well as administrative works, contracting agreements and invoicing did hit the investor's work week time portfolio. It was mentioned, that invoicing procedure is important but monotone and time wasting procedure (accepting invoices, importing them to the local IS systems).

Contractor

time dimension :

Contractor's longest time volumes consumed work processes surprisingly varies between the search and study informations and computations. Probably the ratio of procedures defines contractor's profession branch. Communication, coordination, travelling and other (like administrative processes with the BCA) are having low volume ratio from 1 to 6 percent.

Supplier

time dimension :

Suppliers strongest processes are considered as search & study documents, meetings (from 11 % to 14 % of average values), and is visible that supplier have specific part and supportive collaboration with designer due the fat their activities - graphical projection and computational design are high volumes as well.

Operator

time dimension :

Has most of the work volume focused on the search document (I assume read the IOM manuals for proper operation duties) as well as communication duties via email or telephone, each of them approximately 26 %.

Authority

time dimension :

Highest volume of the official role work duties consist from the search & study activities.

Complex average results are defined on the table in figure below. It is clear that work-time portfolio of each role in the building process varies and depends on the duties over the process.

	DESIGNER	INVESTOR	CONTRACTOR	SUPPLIER	OPERATOR	AUTHORITY
<i>AVERAGE Values (%)</i>						
<i>Meetings</i>	8%	17%	6%	11%	3%	9%
<i>Search informations</i>	10%	10%	17%	11%	26%	15%
<i>Study informations</i>	8%	11%	25%	14%	8%	24%
<i>Design - drawing</i>	34%	1%	2%	25%	0%	0%
<i>Design - computations</i>	16%	13%	21%	17%	0%	0%
<i>Coordination</i>	6%	17%	6%	4%	6%	6%
<i>email communication</i>	9%	13%	9%	11%	26%	12%
<i>telephone communication</i>	6%	8%	7%	6%	26%	12%
<i>traveling</i>	5%	2%	6%	0%	6%	12%
<i>other</i>	0%	7%	2%	0%	0%	12%

Figure 3: Average percentage values of the time consuming by specific work processes structured by the main roles, source: terrain survey evaluation results

Evaluation in the means of Labour effort

	DESIGNER	INVESTOR	CONTRACTOR	SUPPLIER	OPERATOR	AUTHORITY
<i>AVERAGE Values (points)</i>						
<i>search documents, informations, inputs, technical regulations</i>	3.67	4.00	3.50	3.00	N/A	3.00
<i>searching law regulations</i>	2.80	3.00	3.25	N/A	3.00	3.00
<i>revisions and corrections</i>	2.67	3.00	2.50	N/A	N/A	3.00
<i>approoving / rejecting</i>	3.33	3.00	2.50	N/A	3.00	4.00
<i>conceptual changes</i>	2.17	5.00	N/A	3.00	3.00	4.00
<i>meetings</i>	3.40	2.00	2.50	2.50	3.00	3.00
<i>communication inside org.</i>	3.60	3.33	3.33	4.00	1.00	3.00
<i>communication outside org.</i>	3.83	3.67	3.50	3.00	3.00	4.00
<i>looking retrospective for the actual state evaluation</i>	1.67	2.33	2.33	2.00	3.00	1.00

<i>high time loss and time and COSTS waste</i>	1.00
<i>high time loss and time waste</i>	2.00
<i>appropriate time loss</i>	3.00
<i>no loss, good time utilization</i>	4.00
<i>very effective compared with standard</i>	5.00
<i>i dont do this work</i>	N/A

Figure 4: Average point values (according legend) of the effort caused by difficulties during specific work processes structured by the main roles, source: terrain survey evaluation results

In the table above are shown differences of subjective view to each work efficiency and effort. Interesting is situation where investor feels his conceptual change process as very effective and easy, compared with the same kind of process but seen from the side of designer, who sees this process with one of the worst optics.

Interesting fact also is the mutual consensus of conclusion about doing specific “investigation” activity to find the actual state of specific issue, mentioned as “looking retrospectively for the actual state. It is important to note that conflict or problem could grow up to tremendous cost losses and court lawsuits. Each participant considers this activity as necessary for defending himself even it is considered as time and even money loss in many cases.

I must mention that the most valuable data are from designers, investors and contractors. Nor operators nor authorities roles and suppliers did fulfil the questionnaire in the relevant numbers. If I conclude the population of respondents size of 25000, according ideal required level of survey confidence $P= 95\%$ and the ideal required margin of error 10% (now I reached 27%) the survey shall be done in the broader area for receive more answered questionnaires.

In paragraphs below, I mention specific subjective objections to factors causing work inefficiencies, conflicts and cost rising during specific actor’s work duties selected from the survey :

Technology Supplier

Inadequate informations from client (search and study documents), Corrections after construction decisions on site, client’s inefficiency to search specific technical information on his own effort (bad attitude and possibility to search and study documents), overloading of the company employees by work duties, avoiding the responsibility for the actions, lack of time to react to customers requests

Designer

Client’s changing main concept values (breaking the contracted term) repeatedly, changing the design repeatedly (from many reasons), attendance on meetings not related with designer’s profession, controlling of the documentation of professions designer (general designer’s objection), non adequate accuracy, latent knowledge, absence of knowledge, badly agreed contract terms and conditions, lack of input data documentation, absence of control, non exact stated sanctions in the case of contract breaking conditions, lack of time for preparation the design

Investor

Lack of time for eventual control of the numerical (mostly designer’s) computational design, mistakes during own computation (mind concentration)

Contractor

Telephone communication is not recorded, for future retrospective proclamation about specific information transferring to other business partner, non-correct input data for

processing, lack of law knowledge, not correctly evaluated price for proposal caused problems in the next phases of contracted project, lack of the computation design control, the exact meaning of the signed contract (terms and conditions)

Note: other participant's (authority, operator) objections were not relevant.

Conclusion from the survey

The results from the evaluation shows, that continual repeated issue between all of the roles is the lack of efficiency in the searching and studying of the informations. This activity does not reach maximums mostly but is always present.

If we don't include designer's need to draw design (not in the scope of the defined IS), further concluded factors which are decreasing work efficiency is the need of good computational base for preparing the computational design data avoiding the personal mistakes done by lack of concentration and personal overloading, easily controllable by other participants in the roles of contracted partners.

Next important information is the possible lack of fully described terms and conditions in contract, which may be the sources of the future conflicts.

Negative factors to be listed :

- ineffective *informations search* (necessity to prepare effective informations search solution)
- ineffective *computations design and control* (necessity to give opportunity to create and control design design computations effectively)
- ineffective **communication** and its results, lack in agreed informations together (necessity to find tools for communication, monitoring and comparing the measurable activities, factors and states, and for tender contracting)

The aspect of "sustainable growth" and business discoveries in "non-profit" areas versus actual capitalistic view

As we have reached the point after the main problems in construction industry specification, we need to ask about possible solutions. I am certain that in any possible imagined solution a software platform on which the solution will be working on, will have to be created. No matter about content and focus of the processes solving the troubles, but is shall be implemented via information technology. The long age of paperwork, huge paper information archives and long-range searching in it is over. Software is helping in the society over four decades now and we still did not achieve its full potential for grow our development. Software is able to archive terabytes of data and nowadays, actually the big data searching technology hand in hand with business intelligence is taking over the leadership software utilization (mainly) in business.

But is business and profit growth the main target of future societies ? Market indexes of microeconomic subjects - companies and corporates in which belongs profit growth, EPS (Earning Per Share), P/E ratio (Price / Earnings ratio), ROS (Return On Sale), M/B ratio (Market / Book ratio), should not be the main priorities and goals of company boards and should not be priority for investments into companies.

Market company indexes are result of the business activities of company which are the revenues decreased by costs, taxes and foreign costs interests

Ways to evaluate the economic side of each investment are known :

- WACC - weighted average costs of capital (for investment)
- NPV - Net Present Value
- RI /rentability of investment/
- IRR /internal rate of return/

But are they usable within the scope of the Sustainable development for not only private profit earn? We have to consider that each decision made by microeconomic subject is lead by its own priorities based on the capitalistic philosophy raising the profit. These priorities has crucial influence in macroeconomic results of local country's economy. Decisions of microeconomy subjects (here and after referred as the companies and corporations) can be and very often are against philosophy of "*sustainable development*".

To describe the difference : there exists two sides of cost cuts in construction industry (as well as in other sectors I assume) are known - first is cuts without negative influence : selecting and tendering the lowest priced materials, technology or subcontractors. If these tender price negotiations decreasing the contracting time (thus the curve of *demand* and *offer* meets final point of the price/performance and make transaction) and are still in compliance with established criteria of the design, is everything alright. Second type of cuts are the cuts made by some participant of building process (may not be general contractor but i.e. third contractor in the contracted chain) which breaches specific attribute of designed and contracted element of building. On the Figure RP.10 You can see different types of the costs, each related with the closest relation with some specific aspects. Maintenance and operation costs are defined mostly by the quality and type of technology and material use and its operation. Investment costs are most dependent on the decisions made by designer (with investor of course) and on site by contractor. The investment costs can be decreased even more but with negative causalities basically to the internal comfort quality (building user's complains), maintenance costs (building owner complains) or energy balance of the object (building owner complains).

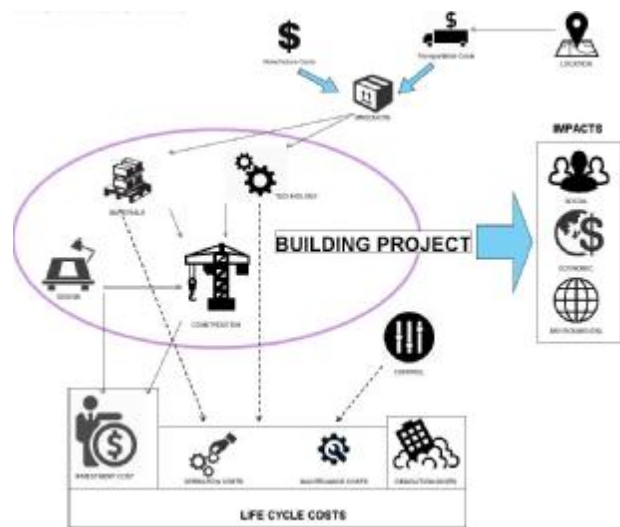

Figure 5 : Rich Picture of conceptual impact relations , source : Visual Paradigm design

When are the best ways to protect project from the failure and how potential costs may be decreased “safely” without the wrong influence to the sustainable aspect of the urban grow.

Methods and ways for conceptual solving - troublesolvers

In the precedent paragraph I did specified first and most important troublemakers and also mentioned the solutions for them - necessities in the parenthesis : effective search solution, design the computations and control them and prepare tools for the communication. Let's focus to the most close one in my profession self-determination - computations design and design of computations. To troublesolve the problem with uneffective computation is of course to compute correct data correctly in the appropriate time. There are clear three dimensions of efficiency. *Data source*, data

processing, and data results available in the appropriate *time*. It answers to the questions, what ? How ? When ? which the efficiency of the process can be measured.

The data source processed needs to be exactly specified.

Basically, data sources are defined from the real world parts from whose whole project is being constructed. Each aspect of constructed project as building, bridge way, road or road roundabout, underground tunnel or motorway has its own physical properties which definitely influence short term costs finances as well as long term costs in the economic point of view. This affection of economy shall not be never neglected. Having the good source data by building elements description of the physical and economic properties is crucial fact on which all the other processes is built on. As economic property I assume the local market price as well as its economic price(value) over time. But which is the best way to store and utilize different kinds of data ?

My aim is thus later describe function for effective search of informations and informations classification specification.

For the exact definition of the troublesolves, we need to ask specific questions based on selected troublemakers.

How software can help in the process of

- strengthening the correctness of decision-making process ?
- eliminating unexpected cost-rise threats ?
- supporting cooperation of building process participants ?
- integration the Big Data to Multi-scaled planning and efficient design ?
- finding new mathematical conclusions from the existing embedded experience ?
- cut the public costs within public finances funded development projects.

Content description and scope of the work

On the basis of specification “bad aspects” of the workflow processes in construction industry, I will focus to specify gross areas then divided to the basic roles and their most important functions with most necessary graphical explanations and table descriptions of the functionalities. Most important is to determine structure for correct comprehensibility of all relationships of the roles. Construction process is based on planning which is divided on the substantially different processes but are together consequentially influenced.

Planning processes, considered as role with high importance and influencing different zones of focus.

- spatial planning
- building / structure design
- sub-system design

- Spatial planning with the help is intensively used and developed today, as refers [6]. In her work has been tested if and how the software can be used to evaluate current settlement structures and their access to amenities in small town located near-by big cities. It has been evaluated also how can software support planners to show more possible development scenarios tested under different inputs and decisions made by whether competent authorities or lay people.

- It is mentioned that point of the beginning of the design is subject of sustainability and the importance of cities in attaining the sustainability in the good direction [5]. Multi-scale planning takes up the underlying principles and translates them into mathematical expressions.

- Impacts between multi-spatial and building planning are reversible. My aim in this work is to be closer to building-planning processes and spatial planning will be less mentioned over next parts in the work. It is important to note that the data transfer from the low level of building maintenance and planning to the higher level is necessary for obtaining truthful results in the spatial planning.

- Building project life cycle consists of four phases: *planning phase*, *construction phase*, *operation phase* and *demolition phase* which ends the whole process. Prior to starting the design phase is usually whole plan programmed by investor's business plan programming who initiates the design process. Preliminary design (or *Design Development*) will after authority's and contractor's (or investor's) approvals pass to second step of design – detailed design. This type of design is usually prepared for the construction and is called *Construction Design*. Construction Design be approved also by an Authority institution – BCA (Building and Construction Authority). Different classification of the roles around the building process are described in Figures below.

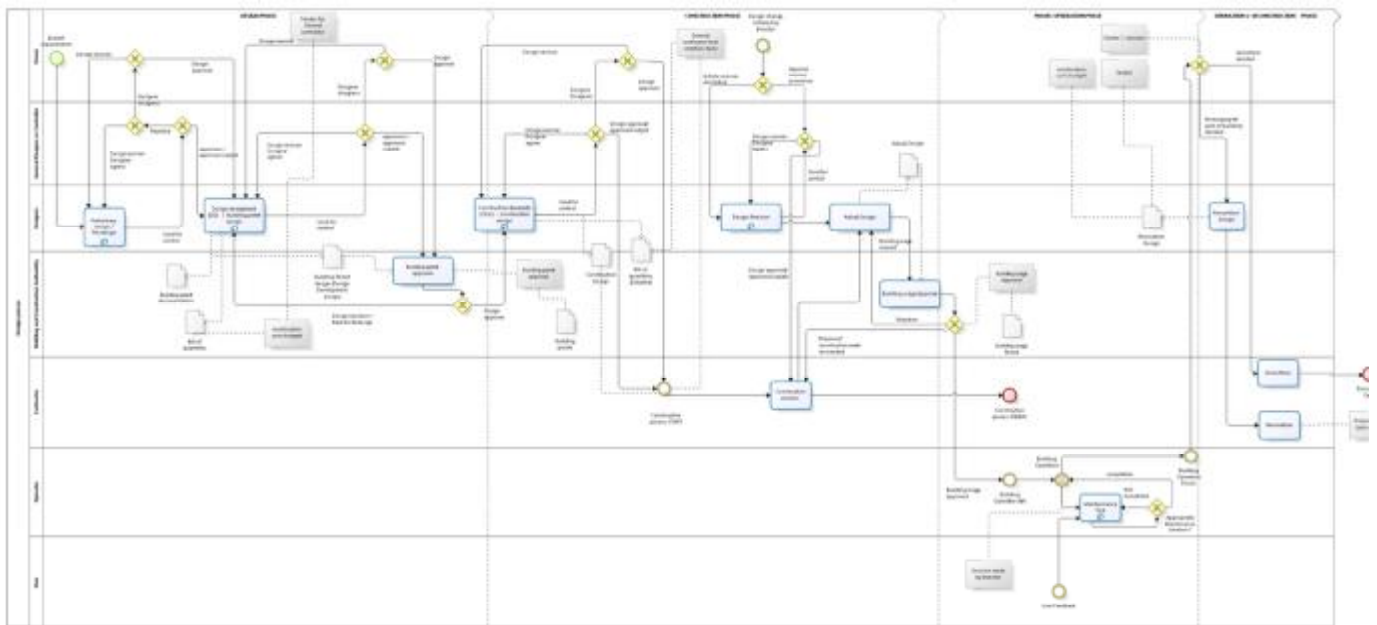

Figure A.1: Project life cycle phases and its activities description. Readable diagram in large format is listed between attachments on the end of work. Source: Bizagi modeller design

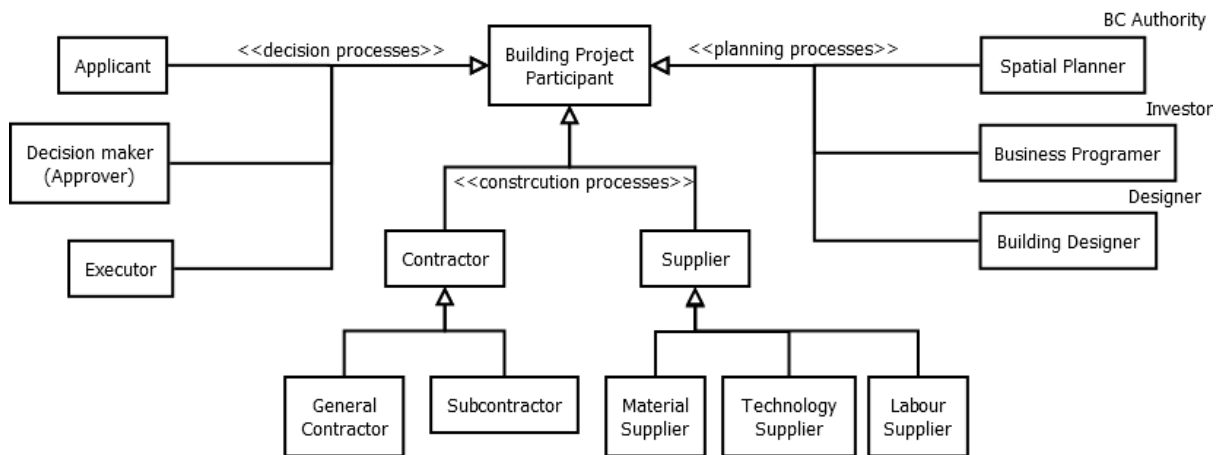

Figure MC.1 – Class diagram of the characteristic roles within Construction process according to the content their duties, source: Diaportable design

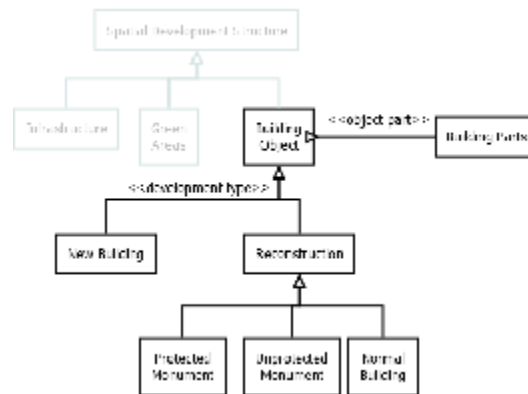

Figure MC.2 - Multiple Classification diagram of Building object distinction

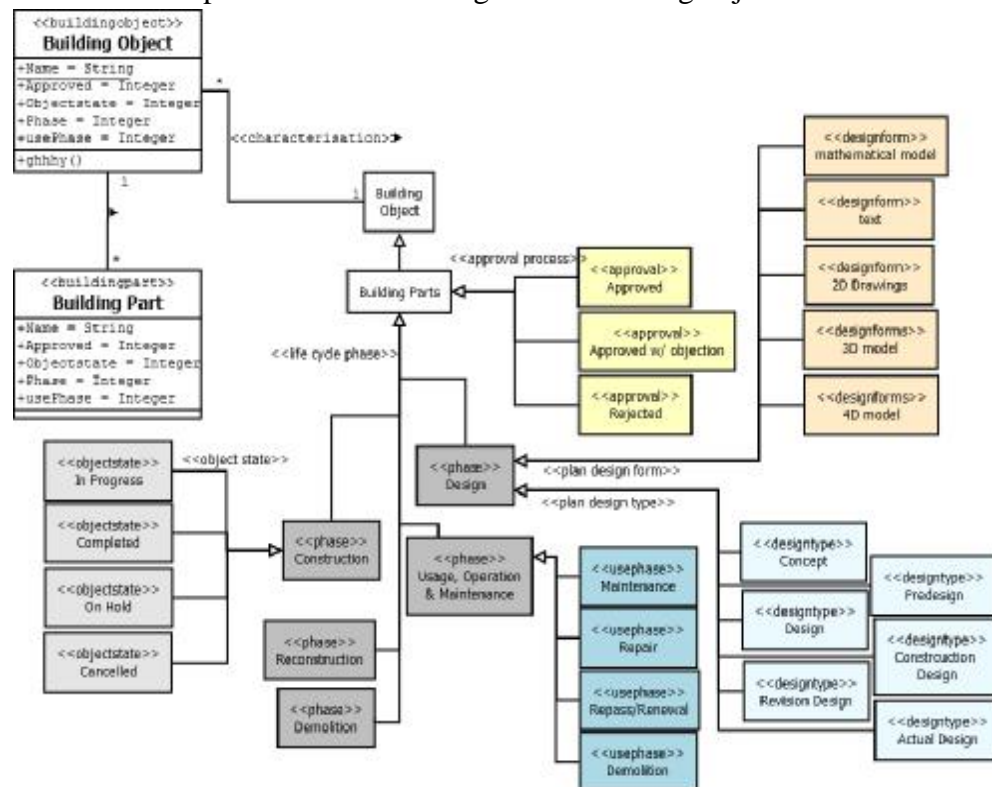

Figure MC.3 - Multiple Classification diagram of *Building parts* objects distinction

The scope of methodology and conceptual work

Multiple spectacle to same case

First considerations about case of building design processes has lead me to conclusion that is wrong describing the construction process just from one sight. Functions of material and machinery can be valid or invalid no matter to its nominal or market prices. There are more different possibilities how to build a house for same functionality or how to heat it up.

Points of view on construction project :

- Conceptual point of view
- Economic point of view
- Technical point of view
- Logistic-organisational-management point of view
- Theoretical point of view

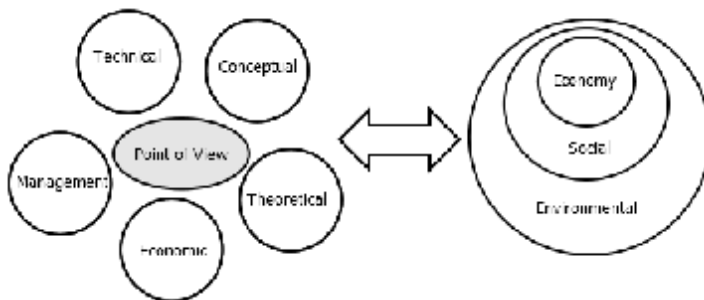

Figure G.7 : Impact to prioritize Sustainable Development pillars according it also Project Design, source : Diagram designer scheme design

Conceptual point of view

The reason to use this point of view is to clarify possible conceptual solutions of the specific problem and ability to evaluate it between them with choosing the best possible alternative for further development and design.

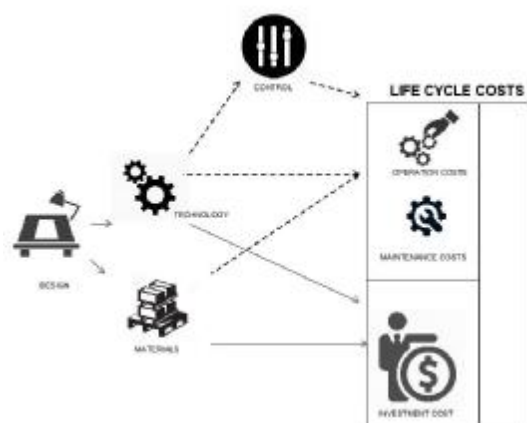

Figure RP.11 : Impact of assets transformation to project, source : Visual Paradigm design

Technical point of view

Technical aspect is enhancing selected concept and embedding it to own design. First conceptual decision either may be changed and revised or may not be. Technical sight includes specific design with all necessary design details need to be set and controlled.

Economic point of view

No matter how good is concept which is decided to realize, but the question is, what is the total cost of investment ? What is total costs of possible life cycle operation ? Is ROI ratio or IRR ratio reasonable ? Can we specify trustworthy cash-flow ? Will be the extra demanded capital for this investment raised easily ? Of course money side of the projects cannot step behind no matter to different views of necessity to take into account the capital situation.

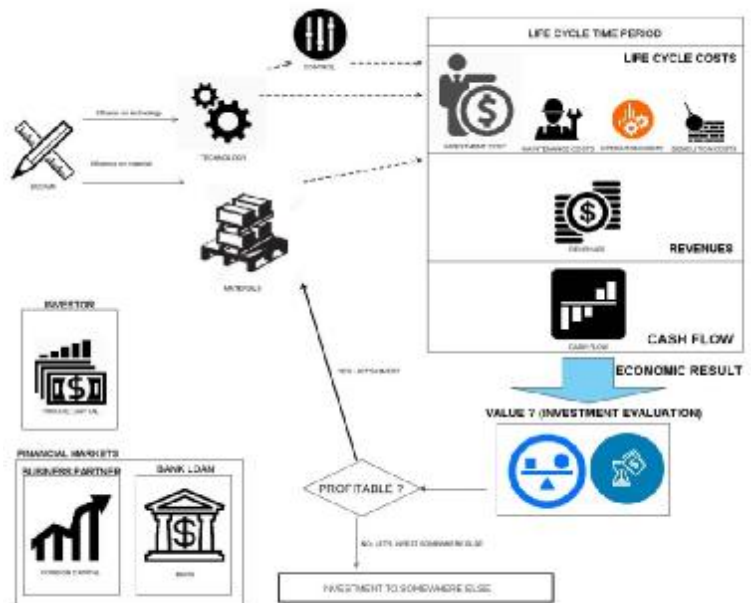

Figure RP.12 : Rich picture of scheme of main factors - different types costs and revenues considered by private investor paid investment by his capital or with cofinance of foreign capital. Is the investment profitable ? How can we know ? source : Diaportable graph design

Logistic-organisational-management point of view

From management sight is necessary to mention it because on from this angle is project controlled if design and construction deadlines and harmonogram is able to meet. From 3D model in project design shall be created 4D model, simulating building process over time - fourth dimension.

Theoretical point of view

If there will be possibility to use andy wide range of data consisted from the specific data elements of wide scale, of course each having its different competitive price and manufactured by the industry, there can be on the digital platform created automated applications which will play the role of whistleblowers whistling during specific circumstances. Let's imagine, circumstances (thus priorities) will be set according the policy of long range ergo they will be using for their evaluating processes

(whistleblowing announcers) data input consisted not only from the local short-term economic evaluation (normal costs and normal revenues called as explicit ones) but also from long-term data for economic evaluation. Long term data could be named as economic costs, implicit costs and revenues as well as possible *externality* costs[7]which shall be, according the etics considering during all of investment process. Are long-term factors taking into account today ? I must note that I had to try think hard to imagine which implicit revenues can be considered into such evaluation. But Bjørn Lomborg [8]showed me its simplicity. and be prepare provide data for cost-benefit analysis [9], cost-utility analysis, risk-benefit analysis, SROI (Social return on investment) analysis.

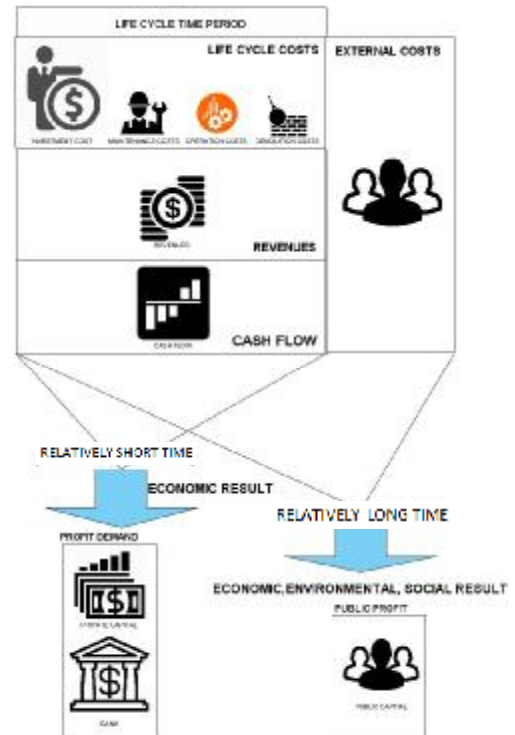

Figure G.13 : Difference between Profit interest evaluation and public interest evaluation, source : Diaportable graph design

Cost benefit analysis (CBA) is consisting from further steps : Process and Evaluation. Process may cost–benefit analysis be defined as :

1. List alternative projects/programs.
2. List stakeholders.
3. Select measurement(s) and measure all cost/benefit elements.
4. Predict outcome of cost and benefits over relevant time period.
5. Convert all costs and benefits into a common currency.
6. Apply discount rate.
7. Calculate net present value of project options.
8. Perform sensitivity analysis.
9. Adopt recommended choice.

Evaluation attempts the positive or negative consequences of specific project, including the activities :

1. Effects on users or participants
2. Effects on non-users or non-participants
3. Externality effects
4. Option value or other social benefits.

IS of the concept design shall help of such processes with their “whistleblowing” applications, described by [10],[11]. With the potential of multi-agent problem

resolving it would be possible to specify ideal water treatment solution for the underdeveloped area with high poor population with exclusive demand for fresh water and other vital attributes for good living. Digital models of drilled wells, dug wells, manual and mechanical pumps, filtration devices and water protection devices together with the data layers of water sources, geomorphologic data maps together with lengths, inhabitant data can be background environment for these solvers

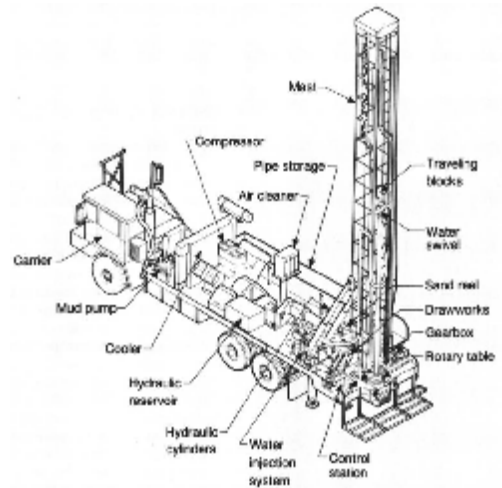

Figure. 5: A large machine-mounted rig for drilling, in Sub-Saharan Africa can cost from US\$ 2,000 to US\$20,000 Source: [12]

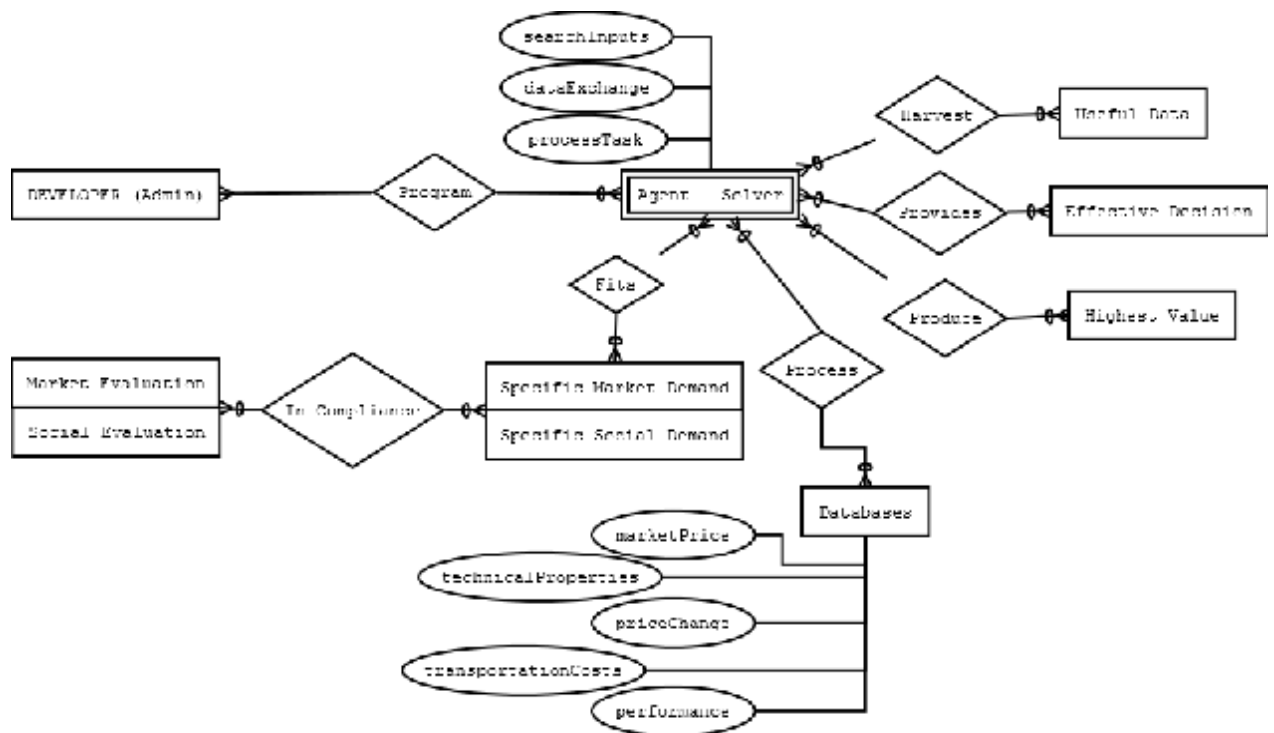

Figure ER.7 : Entity Relationship diagram of application of automated solution solvers (embedded functions), source : Diaportable graph design

In the scope of this work I will not discuss more in detail evaluation from the long-term view from the capacity reasons.

Idea of the information system

What actually is BIM ?

Babel Tower “syndrome” as I rather call it was an aspect which comes from different sights of view of different professions participated at working project. During cooperation of designers inbetween each other and with the contractor were many hidden threats which could show up randomly and negatively influence the process of project construction with its participants. Failures are caused by different aspects but leads to same results - increasing costs, prolonging work time, even losing labour life.

Comprehensible language for all participated parts efficiently sent, translated and understood has become mutual demand from all sides of the building process.

BIM, coming up from IFC (Industrial Format Classes -will be described later on), stands for building information modeling. The BIM concept is not a new idea but is a consequence of the basic needs created in the construction industry and has become more important and feasible over time. It is a way how participants of building process works together and uses methodology for integral design, construction and maintenance of projects, with all participants and partners working throughout the entire lifecycle of project.

Mutual exchange of data is much efficient and faster to comprehend for everybody when used BIM concept. BIM is resulting into complete digital expression of building project. Digital model seen in digital world as “database” is created by the elements belonging to object libraries, for example, digital library of specific plaster board, or window. Each library consists of more possible types of objects and can be additionally created.

These object libraries are usually made by exact material or technology suppliers (manufacturers) called standardized object libraries. BIM model understands all specified definitions of objects. For example it understands definition of window. Window is defined by spatial properties such specific dimensions, material properties such glass properties : absorptivity, emissivity, transparency, thermal conductance, etc. Then these object are defined by the function of the window, and performance, what the window is able to do. Within standardized libraries, you can add more similar object with slightly different properties, e.g. Dimensions, or material type. Definitions, functions and performance of the object are main data which characterizes it, and BIM understand it. With BIM, you make better cooperation comparing to the "classic" design and construction process, and you can do decisions more easily. BIM concept has already have many of object libraries. But how can someone add some new libraries to it ? Is it possible to prepare them somehow easily without necessity of buying expensive BIM designing software ? Answer is yes, data preparation for BIM flows through an open standard data no matter, which commercial BIM software will be used for, data can flow between them or even can be created a brand new data. Free software for input data to BIM can be used.

For work with BIM within Building Authorities the work group committee with Chairman Mr Oivind Rooth has been founded for develop structured sets of standards and specifications and reports specifying methodologies to define, describe, exchange, monitor, record and securely handle asset data, semantics and processes with links to geospatial and other external data. Technical body has name CEN/TC 442 - Building Information Modeling (BIM).

IFC - industry foundation classes

Is open-source data standard working and cooperating with BIM as neutral data transferring format. It is explicitly specified with regulative ISO 16739:2013.

Reasons of saving informations within the building model :

Informations are used not only during the design and construction process but also during the full life cycle of building, when it is necessary to use stored data for maintenance procedures. Informations from the model are useful for coordination and cooperation works of potential maintenance works suppliers.

- Technical HVAC systems of buildings are mostly representing more over of 40 % of total investment costs of building.
- Building informations are valuable also for infrastructure maintenance and development around the building.
- Costs of future reconstructions or maintenance are evaluated and specified more precisely.
- Digital form of documentation should last at least as long as is the lifetime of building.
- Model is used by many technical disciplines, and exact data can be extracted by them on behalf actual demand.
- Data can be used in more applications - graphical presentation, maintenance preparations, technical computations, economic evaluation. To clarify it, BIM software for building design is only one of them.

BuildingSMART - Original organisation is founded in 1995 in U.S. as IAI (International Alliance for Interoperability) which is joined with activities with construction and facility management. Their main aim of an organisation is to create information standard for sharing informations within the construction process till the end of the life cycle of object.

Relation of scope of my work with BIM and IFC : Smarter Ways for Working

Relation between the Cloud application described in my work and both BIM and IFC must be very close. For description Cloud application concept, it does not replace BIM purpose. The cloud (IS) shall absorb and store BIM and IFC objects and extract from them required data. I put the priority to the IFC prior to the BIM because BIM format has many versions depend on the commercial softwares. IFC is universal. Referring to the paragraphs about specification the troublemakers and troublesolvers, when the situation when specific information is needed, is available when is needed and the quality of this information is appropriate, then this process processing these informations for specific reason can be improved, or, created for work processes improvement.



Figure RP.8 : Rich Picture - simple description of influence of one profession's design change to others. This shows the necessity to resolve possible relations and influences of different elements which could create bigger groups- systems. Source : Diaportable graph design

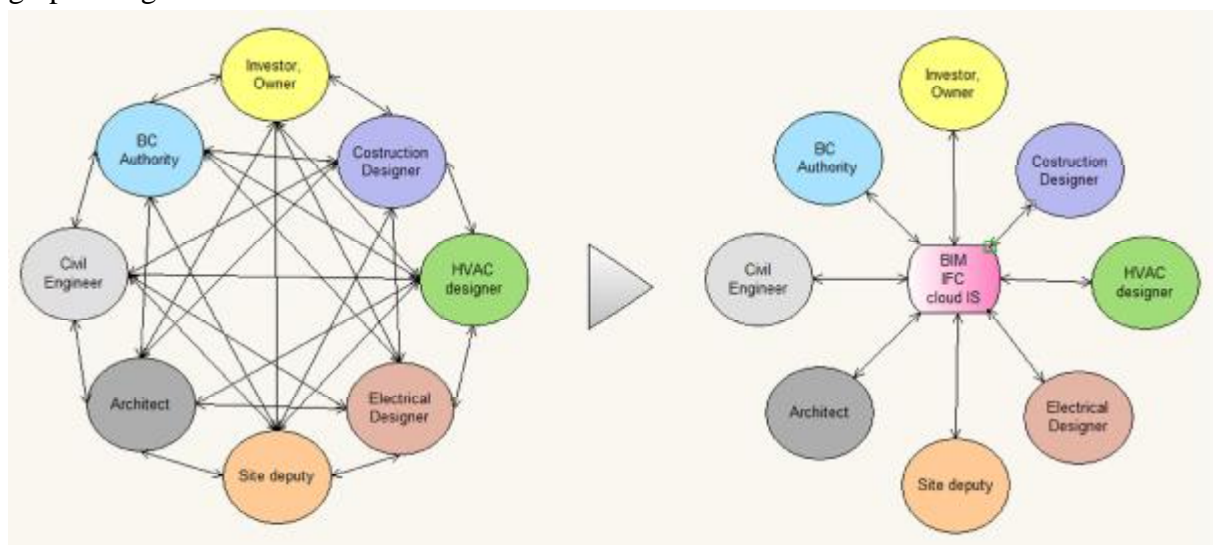

Figure G.2 : Construction Design transformation to BIM, source : Diagram designer scheme design

IFC - Industry Foundation Classes , object for data sharing in the construction as well as in facility management industries is information format determined by ISO 16739:2013, who is specifying data schemes and exchange file format for BIM data. According the *conceptual schema* is using Clear text encoding of the exchange structure for exchanging and sharing data. According above mentioned technical regulation, the IFC represents an open international standard for data exchange among different commercial software applications. Standard consist of the *data schema*, represented as an *EXPRESS schema specification*, and reference data, represented as definitions of property as well as quantity names and descriptions.

According the International Organisation for Standardization, the IFC exchange format contains definitions which are required for the life cycle phases of buildings :

- demonstrating the need;
- conception of need;
- outline feasibility;
- substantive feasibility study and outline financial authority;
- outline conceptual design;
- full conceptual design;
- coordinated design;
- procurement and full financial authority;
- production information;
- construction;
- operation and maintenance;

The exchange format definitions are also required by the various disciplines involved within the life cycle of building project and includes also project/object structure; physical components; spatial components; analysis items; processes; resources; controls; actors. Softwares like Tekla BIMsight, Solibri, Pedestrian simulation tool, Simergy, dRofus, Grasshopper modeling module for Rhino, Solibry SimpleBIM IFC, BCF editor are using now IFC format on daily routine.

IFC information model description

Industrial Foundation Classes are wide to complexity of data included in the IFC file. Although I am not able to describe broad spectrum of its properties, I will show just examples for giving small inside view to their structure.

IFC contains wide range of data definitions which are used further by the softwares. This functionality shall have the predefined IS in this work also.

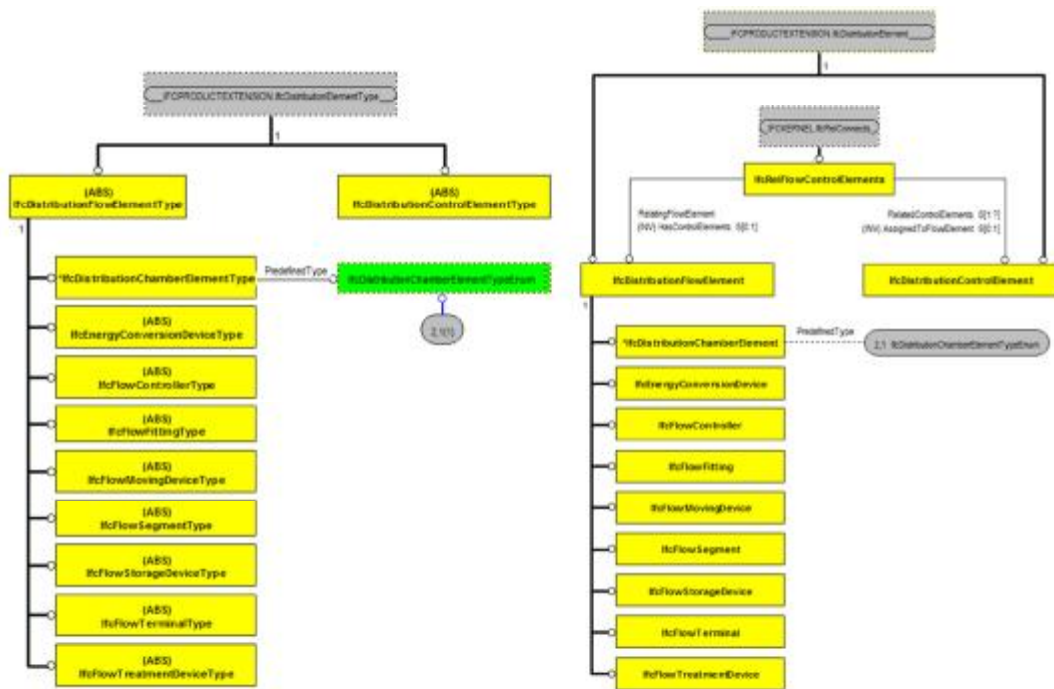

Figure 18: Class diagram of objects (flow elements) in relative (abstract) in the left and in explicit selection with distribution control element on the right, source: [18]

5.1.2.44 IfcRoot

According to these specification informations from [18], it is the most abstract root class for all IFC entity definitions which is rooted in the kernel or in subsequent layers of the IFC object model. It is although a common supertype of all IFC entities, besides those which are defined in an *IFC resource schema*. All entities that are subtypes of `IfcRoot` can be used independently, whereas resource schema entities, that are not subtypes of `IfcRoot`, are not supposed to be independent entities.

The `IfcRoot` assigns the globally unique ID, and the ownership and history information to the entity. In addition it may provide for a name and a description about the concept.

EXPRESS Specification

ENTITY `IfcRoot`

ABSTRACT SUPERTYPE OF(ONEOF(`IfcObjectDefinition`, `IfcPropertyDefinition`, `IfcRelationship`));

`GlobalId` : `IfcGloballyUniqueId`;

`OwnerHistory` : OPTIONAL `IfcOwnerHistory`;

`Name` : OPTIONAL `IfcLabel`;

`Description` : OPTIONAL `IfcText`;

UNIQUE

`URI` : `GlobalId`;

END_ENTITY;

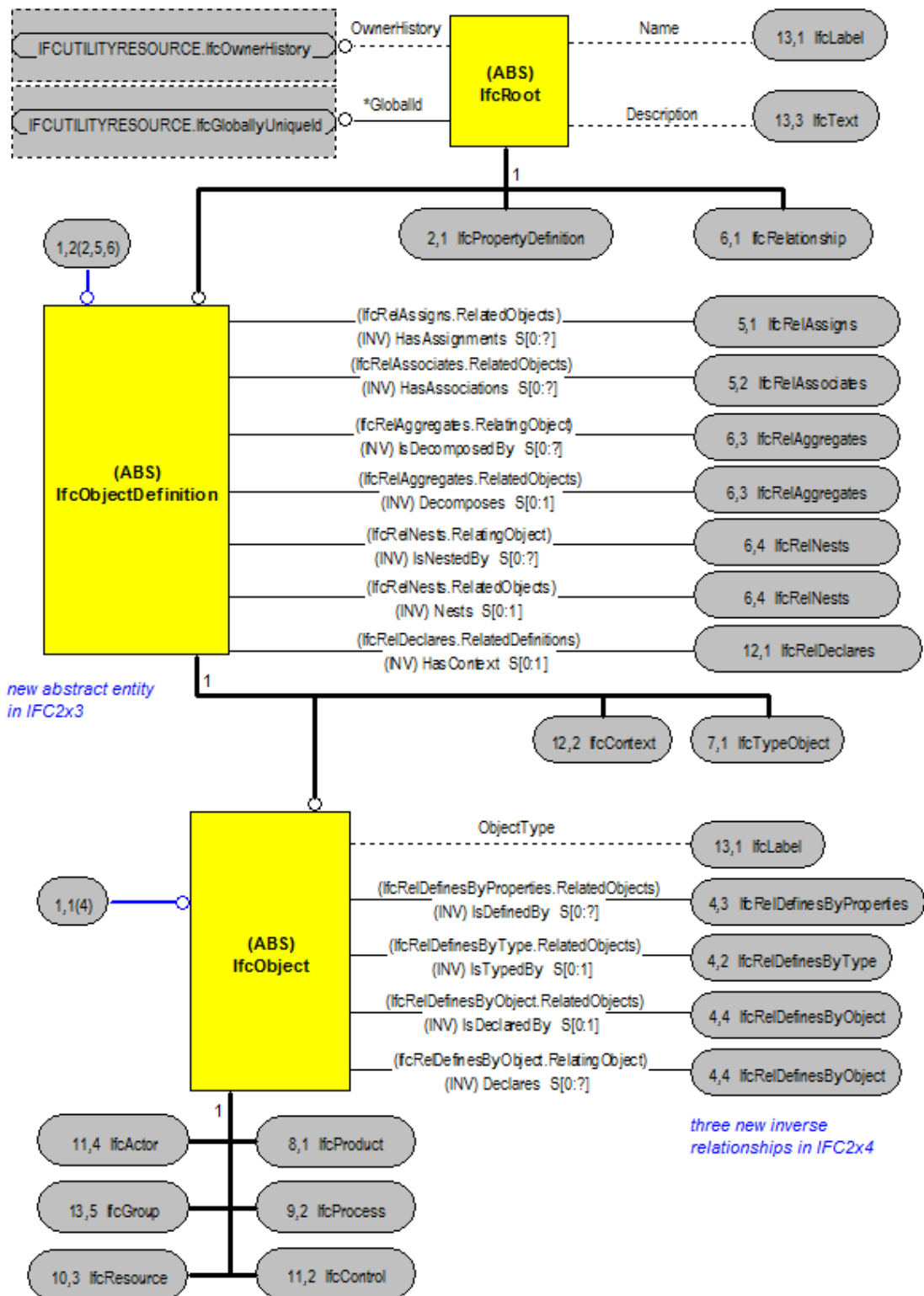

Figure 19: Class diagram of the root class structure of IFC entity definitions, source:[18]

The flow terminal type **IfcAirTerminalType** defines commonly shared information for occurrences of air terminals. The set of shared information may include:

- common properties with shared property sets
- common representations of shape
- common materials
- common composition of elements
- common ports
- applicable assignment of process types

It is used to define a air terminal specification (i.e. the specific product information, that is common to all occurrences of that product type). Air Terminal types may be exchanged without being already assigned to occurrences. Occurrences of **IfcAirTerminalType** are represented by instances of IfcAirTerminal.

IfcPropertySet – the exemple of the most used IFC attribute

The *IfcPropertySet* defines all dynamically extensible properties. The property set is a container class that holds properties within a property tree. These properties are interpreted according to their name attribute.

The same *IfcPropertySet* can be assigned to multiple object occurrences, it should then be assigned by a single instance of *IfcRelDefinedByProperties* to a set of related objects. Those property sets are referred to as shared property sets. It can also be assigned to an object type.

Enumeration identifier example (attributes)

EXPRESS specification:

```
TYPE IfcDistributionSystemEnum = ENUMERATION OF (  
    AIRCONDITIONING,  
    AUDIOVISUAL,  
    CHEMICAL,  
    CHILLEDWATER,  
    COMPRESSED AIR, (or other mentioned below  
END_TYPE;
```

This enumeration identifies different types of distribution systems.

Valid enumerations for :

pipes and related elements include:

- CHEMICAL: Arbitrary chemical further qualified by property set, such as for medical or industrial use.

- CHILLEDWATER: Nonpotable chilled water, such as circulated through an evaporator.
- COMPRESSED AIR: Compressed air system.
- CONDENSERWATER: Nonpotable water, such as circulated through a condenser.
- DOMESTIC COLDWATER: Unheated potable water distribution system.
- DOMESTIC HOTWATER: Heated potable water distribution system.
- DRAINAGE: Drainage collection system.
- FIRE PROTECTION: Fire protection sprinkler system.
- GAS: Methane distribution system.
- HAZARDOUS: Hazardous material or fluid collection system.
- HEATING: Heated water distribution system.
- OIL: Oil distribution system.
- RAINWATER: Rainwater resulting from precipitation which directly falls on a parcel.
- REFRIGERATION: Refrigerant distribution system for purposes of fulfilling all or parts of a refrigeration cycle.
- SEWAGE: Sewage collection system.
- STORMWATER: Stormwater resulting from precipitation which runs off or travels over the ground surface.
- VACUUM: Vacuum distribution system.
- VENT: Vent system for wastewater piping systems.
- WASTE: Waste collection system.

for ducts and related elements include:

- AIR CONDITIONING: Conditioned air distribution system for purposes of maintaining a temperature range within one or more spaces.
- EXHAUST: Exhaust air collection system for removing stale or noxious air from one or more spaces.
- VENTILATION: Ventilation air distribution system involved in either the exchange of air to the outside as well as circulation of air within a building.

for cables and related elements include:

- AUDIOVISUAL: A transport of a single media source, having audio and/or video streams.
- CONTROL: A transport or network dedicated to control system usage.
- DATA: A network having general-purpose usage.
- EARTHING: A path for equipotential bonding, conducting current to the ground.
- ELECTRICAL: A circuit for delivering electrical power.

- **ELECTROACCOUSTIC**: An amplified audio signal such as for loudspeakers.
- **LIGHTING**: A circuit dedicated for lighting, such as a fixture having sockets for lamps.
- **LIGHTNINGPROTECTION**: A path for conducting lightning current to the ground.
- **POWERGENERATION**: A path for power generation.
- **SECURITY**: A transport or network dedicated to security system usage.
- **SIGNAL**: A raw analog signal, such as modulated data or measurements from sensors.
- **TELEPHONE**: A transport or network dedicated to telephone system usage.
- **TV**: A transport of multiple media sources (e.g. analog cable, satellite, over-the-air).

From the examples description is clear that IFC object data type is developed to de detail and fits for the purpose of the IS as the main data exchange and data storage format.

Used methods and tools for software development

UML and RUP methodology

I have to prepare and manage requirements, which would be done by creating the use-cases for capture functional requirements, in the meaning of Rational Unified Process method (RUP) creation. RUP shall be good methodics for developing the cloud system which is the scope of this work. In the time, the process development in time are divided to the time stages : Inception, Elaboration, Construction, Transition phase. Disciplines for the software creating with RUP are deploying IS beginning the Business model creation and maintenance of the requirements, analysis and design of functionalities, going through their implementation within the IS and its testing, finally arrived to the state of testing and final deployment of an application (system). All these basic workflow activities done side by side with supporting activities as Project Management, changes and configurations management and the environment [13]. In my thesis I must stay on the first two workflows of the RUP - business modelling and creating requirements. RUP development is based on the Six best practices of the software development, mentioned below.

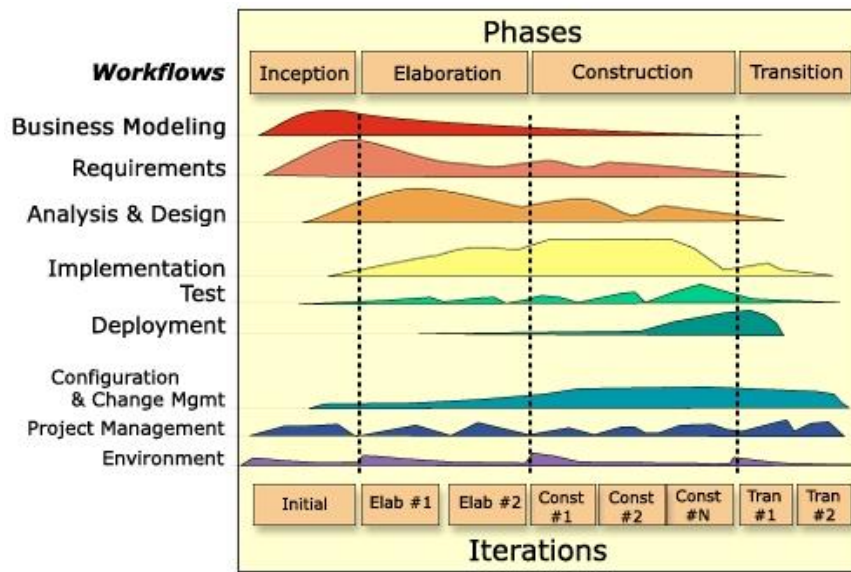

Figure G.7 phases and structure of Information System development, source : [14], [21]

Iterative development of software

Actual need for the complex systems creation does not allow to create software by traditional “waterfall” way of its creation, it is not possible to continue sequentially all the time with firstly specify problem then its solution creation and its testing and interfere another issue sequentially. Main problem of the waterfall system development is, you do not have straight feedback of full functionality the of solution, because testing is occurred just on the end phase. If this would be a method for complex system testing, the repairing code difficulties at almost end of the process would be enormous.

Iterative approach of development the software brings few advantages in comparison with the traditional development methods. Serious misunderstandings between developer and customer would be well discovered during continuous testing of created applications as the born over the development time. Wrongly defined and not working applications discovered just on the beginning of their development is much cheaper to reconfigure than on the end where other application layers would be finished. The already prepared versions of applications are deployed and offered to users for usage (testing) which brings back valuable feedback. Developing team is thus forced to focus on the functional and most important aspect of their activities for giving the required results with the help of the user’s feedback. Continuous iterative testing and coding is allowing to evaluate truthful state of the system as a whole.

Requirements management

During of the software development over the time may the requirements change and is necessary to evaluate the possibility of change appearance. Not taking this threat into account, project may face negative economic and technical influences in the future. Is the common fact, that during development the customer modify and extend his

requirements for the system. Management and classifications of the requirements may define the priorities of each and evaluate its functional efficiency, performance and gives opportunity to evaluate the mutual compatibility and dependences.

Utilisation of the Component Architecture

Architecture of the system depends on group of important decisions : organisation of system, selection of the basic elements and its interfaces from which the system is created and their behaviour and specification of their mutual cooperation, construction of the structural elements continually to bigger subsystems and definitions of their behaviour.

Architecture of software is not only focused to behavior but to the ability of reuse, comprehension, usability, functionality, performance, robustness, economic and technology restrictions, contract terms and estetic point. Creation of the robust architecture is essential because it defines future reusability, separates hardware and software dependencies which would help during the need of their change.

Software architecture may utilize already existing components for the development from many of the commercial sources. Prepared components is possible to modify and reuse for actual project. Platforms offered by Enterprise JavaBeans (EJB), Object Management Group's (OMG), Component Object Model (COM) are supported platforms on which is the component architecture possible to use.

The utilisation of the component architecture together with the iterative development comes up with possibility of perpetual measurement and ability to flexible update and evolve it over the time.

Visual modeling of Software

As mentioned in [17], model of the software is simplified view to the reality from many scales and angles. The models are created to better understand the structure and functionality of the systems which needs to be developed and needs to meet specific requirements. To wide and extensive systems is not possible to understand in a while. Importance of modelling is evident when You have necessity to communicate in large team of developers, which ideas and thoughts needs to cooperate main goals of project. Modeling helps developers to describe, specify, create and document the behaviour, structure and states of the system architecture. UML language offers to developers effective communication on which basis they form mutual cooperations, statements and decisions [16]. If there are selected the right modelling tools, it is possible during each iteration to synchronize the models and source code.

Continual quality control

The functionality control involves the creation the sets of tests for each key scenario. Each of these key scenarios is describing one and required behaviour model of system. It is evaluating, which scenarios during test did not passed and reasons of their failures. If development is done by iterations, the applications are tested during each

iterations. This is considered as continual control of the quality. Main advantages of the continual quality control is early error codes determination over the development which helps to decrease the costs of code repair.

Changes management

During development of extensive systems can cooperate more development teams in more geographic places and creating and implementing their part of the code and to iteration circle of the system. Miscontroll of the changes implementation would degenerate the development process to chaos. Necessity of the activities and code artefacts coordination requires to create repeating workflow controlling the changes of the SW and its artifacts. This coordination will offer better allocation of resources which are based on the threats and risks of projects. With the iterative development method is this change management allowing continuous changes monitoring, which leads to problems determination on which is possible to react fast.

Changes management is formally defined and repeatable, requirements for the change are helping with clear and explicit communication, work duties division between the team members and teams is lowering the risk of the work duties crossing between them and the statistics of the changes amount is good metrics for evaluation of the project's situation.

Objects

Object around us can be specified as material and abstract ones. Object from material world, in the scope of this work, objects which will be or are installed or constructed at the building site has material character. For the reasons of project planning philosophy is needed to give them an abstract, digital form. Modern software can plan and simulate building processes with this abstract basic building element - abstract object.

Abstract object is characterised by its information structure . It has an attributes and is doing specific operations. Attributes and operations are characterised together as *properties*.

Associations are relationships between separated objects. Any of object from specific class can be associated with any possible number with objects from different classes.

An aggregate is type of association, which is consisting from more different components (objects) at same level of importance. When one of this component is not cooperating in aggregate, whole aggregate may not work properly (similar situation is when you detach from working desktop computer i.e. monitor or keyboard, without them is not possible to operate desktop computer properly).

Composition is special kind of aggregate, where one group of components are below another components in importance and will not influence the whole functionality of composition, even if they will be missing - as an example are few leaves missing from a tree.

Analysis, possibilities and expansion availability

Mondis project - my motivation and its basic analysis

MONDIS is a research project which is developed in partnership between CTU Prague (Faculty of Electrical Engineering, Dept. of Cybernetics) and institute of Theoretical and Applied Mechanics (AS ČR), vvi. It is knowledge-based system which strong advantage is to store kind of *incomplete informations* which can be continually supplemented in the time, simple modeling of hierarchies and derivation of property characteristics by logical reasoning. Its main goal is to create efficient platform for experience exchange, collaboration and integration of existing knowledge of the cultural heritage of buildings and structures protection. MONDIS focus on storage of informations about damages and failures of buildings - in its case are the cultural heritage object preferably. It is Analysis tool of dependency between failures and their causes, allows prepare damage mitigation and intervention plans within the evaluation possibility of risk factor of failure and their preventions. System include web user interface database and mobile application for mobile platforms for visual inspection purpose on site. Foundation for this knowledge-based system lays on te conceptualization of relations between factors using principles of ontologies and semantic web (OWL) [19].

Users of MONDIS do most often two basic actions in the system : inputting and searching of knowledge. System is providing usable informations for three different community of users and is able to maintain their different point of look to the subject :

- Technical group = Architects, engineers, conservators and restorers etc.
- Administrative group = Owners of cultural heritage objects, authorities, trusts and associations etc.
- Research group = Academics, scientists and researchers etc.

Guide for *KnowledgeMatrix* interface

KnowledgeMatrix which is table dynamic interface which is showing you general dependencies of historical monument defects and their causes, based on your query (input) to the interface. You simply specify building element or building material which you are interested in and interface will show You all existing element/material failure possibilities. First column represents consequence of the failure (ManifestationOfDamage). Ways how to stop damaging mechanism describes second column. Third column is describing the specific ways of avoiding the agent performing the damaging mechanism. In pop-up window you can see more informations about advantages of the interventions, their possible applications and their procedures and possible standards with example pictures.

Terminology editor

Terminology editor helps users of system for editing and supplementing the glossary. Glossary is structured according MONDIS ontology and thus reflecting semantic hierarchy of therms used in the building structures culture heritage domain. Its function is to manage concepts stored at ontology by either editing or creating new

concepts. It gives possibility to save informations into another language version, add new comment or specify synonyms by using the “label” text field. Methods how can be such ontology driven database created can be found in [20].

Last days of architectural monuments ?

From the project Mondis I flow straight into the problematics of monuments. The problematic of monuments has specific aspects which could help to improvement their protection with the short and long term aspect. As consideration of the IS as the Mondis extension, there can be proposed more divisions of the monuments into the detail. Nowadays it is usual, than even old building with industrial architectural authenticity lacks in the public interest and is demolished. Potential of networking via the IS may be efficient by the informations spreading inbetween lay public.

Requirements of the restored monument buildings

Starting point of the monument buildings handlings for their conservation, utilization and documentation are international charters, resolutions or declarations created for this reason. Main matter of such documents is the question of actual technical intervention with absence of negative influence to existing architecture and historical environment. Fact is that actual approach of different documents made by different institutions or groups of institutions is not the same but no matter that fact, similar aspects are encouragement to monument solicitude and periodical maintenance and protection of monuments, avoiding their destruction.

According to work of [21], the criteria of evaluation of historical value of *industrial monuments* are not similar to monuments of residential, sacral, or public buildings, because specific building evolution dynamics is often present. Criteria used for evaluation of general monuments are used also for the evaluation of industrial monuments, but they are part of bigger group of criterias used.

We can without hesitation state that *conversion* of building do different utilization with help of reconstruction We can assume as natural part of the life cycle of building. Main difference between industrial monuments and normal monuments is causal junction of the building object with technological equipment installed wether inside or around the object.

Evaluation of Industrial architecture

In industrial buildings is often the historical value of it joined together with technical installation in the building, so called Double-substance [23], own building and technology or mechanical installation. The reason of different installations inside building is the building utilization in specific branche during industrial era. Difference of these two substances could be the technology modernisation process which could

occur periodically and divide the moral service life of substances. This phenomenon is one of main s characteristics of many industrial buildings.

During evaluation of each object from area separately, is specific definition of the importance of specific characteristics and imporants of a whole more individual assesement than general specified scale of criteria.

Criteria for the further evaluation of the builging were defined [21] :

Main evaluating criteria

- Total typological relevance
- Presence and completeness of technology installation
- Footprints of operation as evidence of real operation.
- Criteria and value of age
- Criteria and value of cultrual work
- Documentrary criteria and value

Preservation of the shape mass and indentification marks :

Preservation of

- construction
- Size and placement of windows openings
- Windows
- Facade surfaces
- Decorative elements on facade
- Shape of roof

Monument values :

- Authenticity
- Urbanistic
- Architectural
- Aesthetic
- Uniqueness
- typhicalness

Specific preservation or reconstruction processes shall be for protected monuments reconstruction stated as recommended for specific kins of structures.

The IS shall include list of all possible technical solutions usable in practice for the reasons of industrial monuments maintenance and reconstructions. (which Mondis arrange today) This informations presence would have hight benefit and impact for the branche. Knowledge database shall be open-accesible system, which will be able to absorb further input informations over its operation duty, able to add more possible solutions and work processes.

Looking back to Mondis, It shall have form of methodical guide of recommended activities and interventions for facility management companies, users or owners of

objects as well as presenting and monitoring tool of the employees of antiquities authority.

Chapters of Practical work

Informations and its management

Informational System design

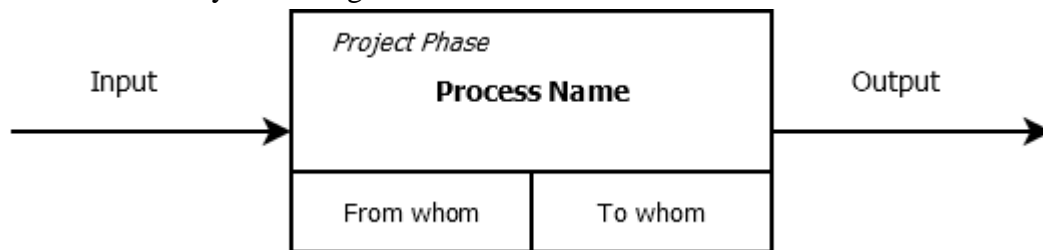

Figure G.5 - Basic notation of process, source : Diaportable graph design

Resources : identification of subject who indicated or created process or person to whom it has been sent.

CaseID : Case identifier, called as process instance ID

Activity/Event ID : names of different process steps and status changes, which are causes or consequences in the processes. There should be a history of data logs saved of this this element, for requirement of process mining, as Schaijk [23] mentions at his study.

Timestamp : timestamp of each process is valuable information for setting data to the right order. It can be then used for processes time length , time gaps and delays between processes and theirs bottleneck identification [23].

Storage of data : For data storage should be necessary to create an event log with at least these informations : case ID, event ID and timestamp.

Very common form of event log exports is in .csv format.

It should be also possible to distinguish specific kind of event logs joined fith specific BIM (or IFC) product, which could be named differently from different reasons, as different control systems or different employee description, even it is meant the same product in the model, as mentioned in [23] , descriptions like 'Personenlift', 'personenlift' and 'personen lift' is the same technology sub-object in building object (model).

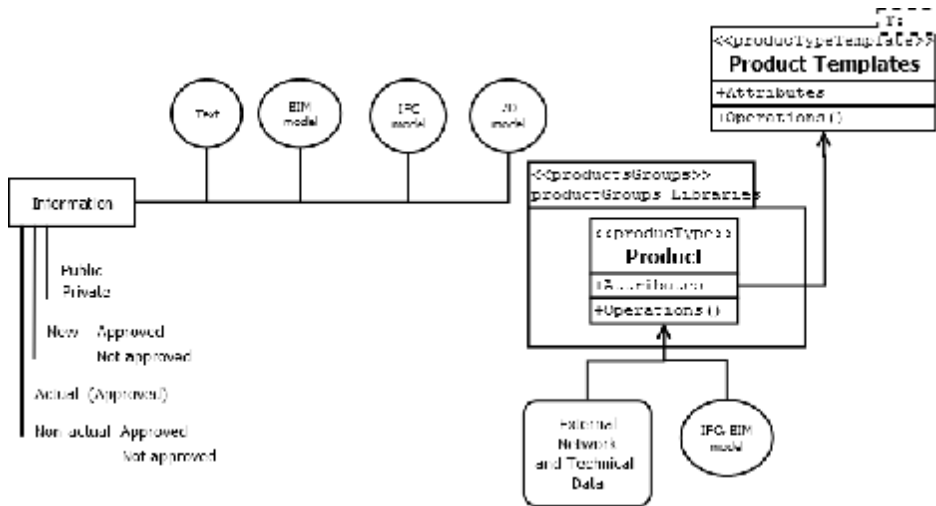

Figure G.14: used packaged information characteristic, source : Diaportable graph design

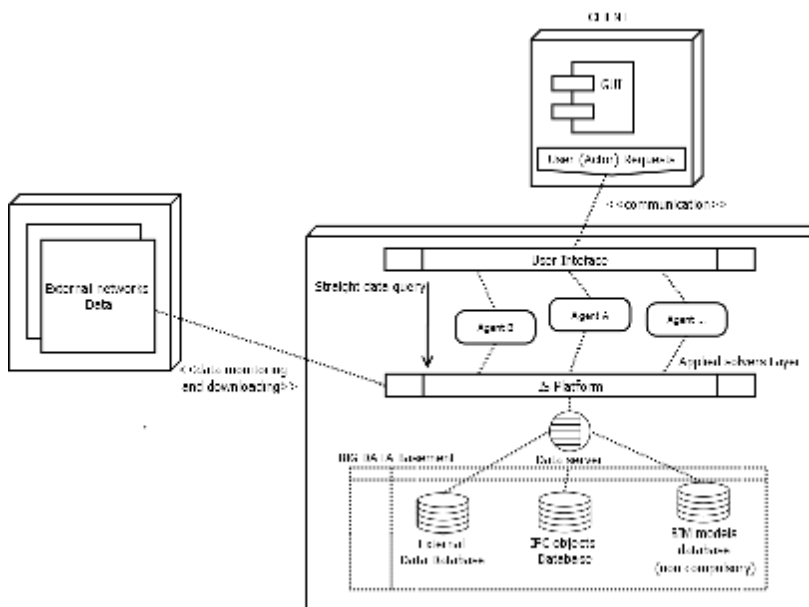

Figure G.15 : basic IS concept description, source : Diaportable graph design

Focus to functionalities for Designing phase - Designer Actor role functionalities Description

Digital expression of physical product needs to have beside already existing BIM model very well described technical characteristics of the product, defined by manufacturer and specified according to them into Pre-design (or *conceptual design*) by Designer role. We already know and use BIM, so let's focus to the other, but also very important part.

As seen in the Figure G.14, for comprehensive understanding the IS by user, the different types of informations the IS is treating is drawn. It can be divided into *static*

kind of informations which will be continuously saved within database but nothing more can be done with them but read only, and dynamic informations, which are created from static information elements.

Static informations we name static because they will be “stored when You leave them”. Different level, upper level is a simple data package. At Figure G.14 it is described as class with *stereotype* or(*interface*)<<productType>> which is describer of the product as “digital mirror”. Static technical data will be after specification of product type data structure only *imported* and *product object* will have full packaged data ready for use.

This is for the whole understanding of working process of whole system crucial. Let’s imagine we have already prepared data package of product, for example, water pump with variable drive motor, ready to be used. It has already set its own structure of properties, such weight, dimensions, minimum and maximum flow in liters per second, starting and operating currents, power. Power consumption will be described with polynomial expression of 3 variables, which will specify consumption of energy for electric motor according variable inputs : required head pressure, and required volume flow.

Now the producer of this pump will suddenly change some of manufacture property, because of his design evolution development, or change of legal regulations. Suddenly he use new redesigned water turbine in it with slightly different material. This change will have an impact at the “*static*” data imported into the *product object* and again, it will be ready to use as soon as new data will update. This is very efficient and flexible way to store data and change new data also in the order and it stays very flexible. Name of update will specify only new “generation” of product by timestamp with different name type of product. Another advantage is, possibility to use older mathematical models of products will be also possible.

It is important to mention that already in this second level of data storage in the product models is necessary to consider product object as mathematical models, because it may contain mathematical expressions describing work and behaviour of product.

To sum it up, static data will be implemented to the *product object* which will be considered as the basic building brick for designer. This product object called here is needed to be treated as *mathematical model of product*. I need recall only, this is similar data type as any mathematical expressions of 3D model expression of the product. This is already solved in IFC and BIM model objects, as seen described in Fig G.14 on the right down place as well as on the Figure G.14.3 on the bottom parts.

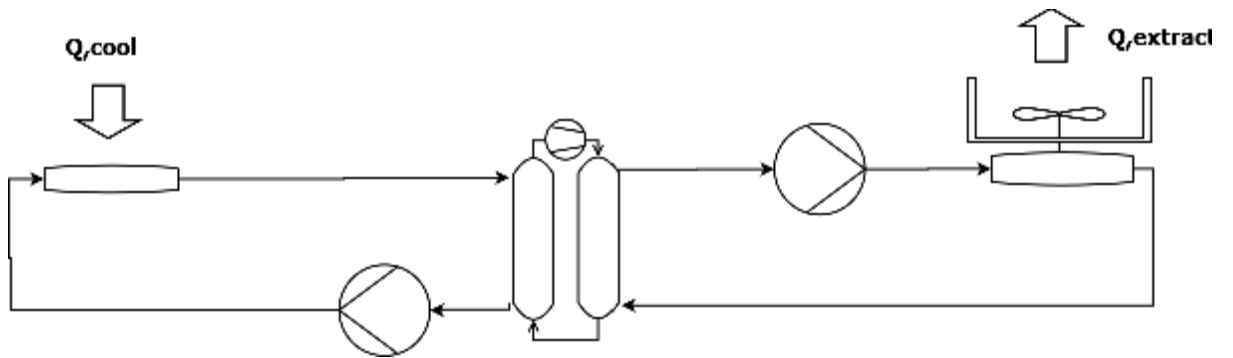

Figure ER.0a : Conceptual scheme of grouped specific product object templates into specific *design concept* template. This scheme contains same structure of objects in Figures ER.0b, ER.0c but on the more simple layout without showed data in the class model. Product (default) objects shows data attribute on the most simple level. Source Diaportable graph design

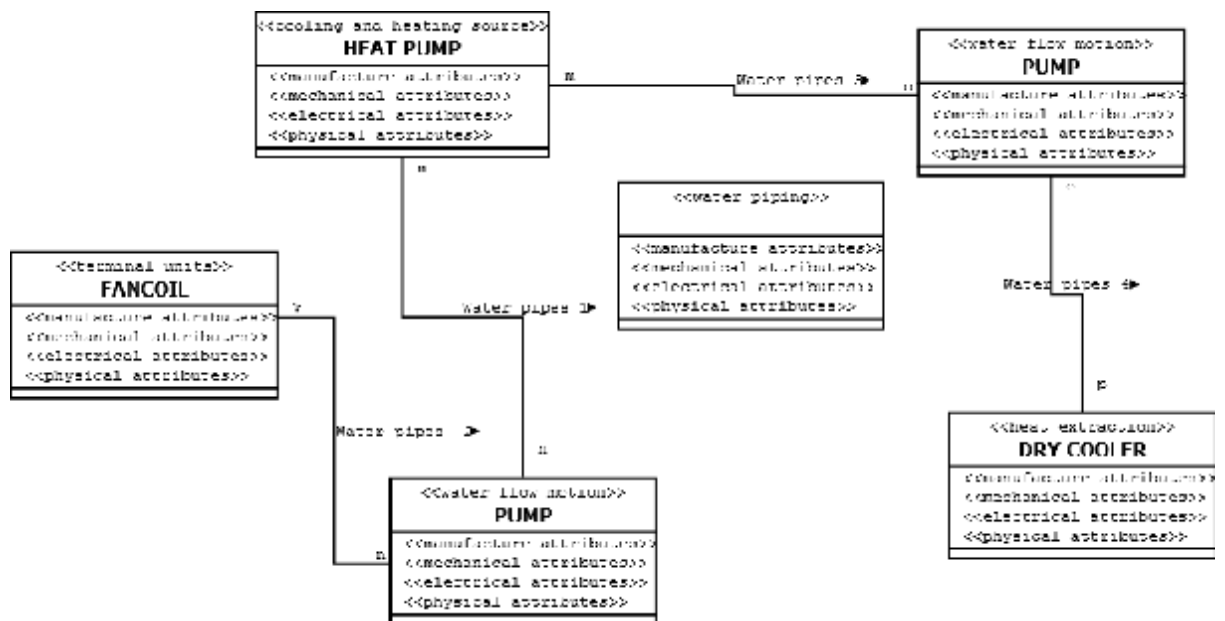

Figure ER.0b : Class diagram of basic data classes of the specific part of the conceptual scheme of cooling system. *Water piping* describes all the connections between other elements. Product (default) objects shows data attribute on the basic level. Source Diaportable graph design

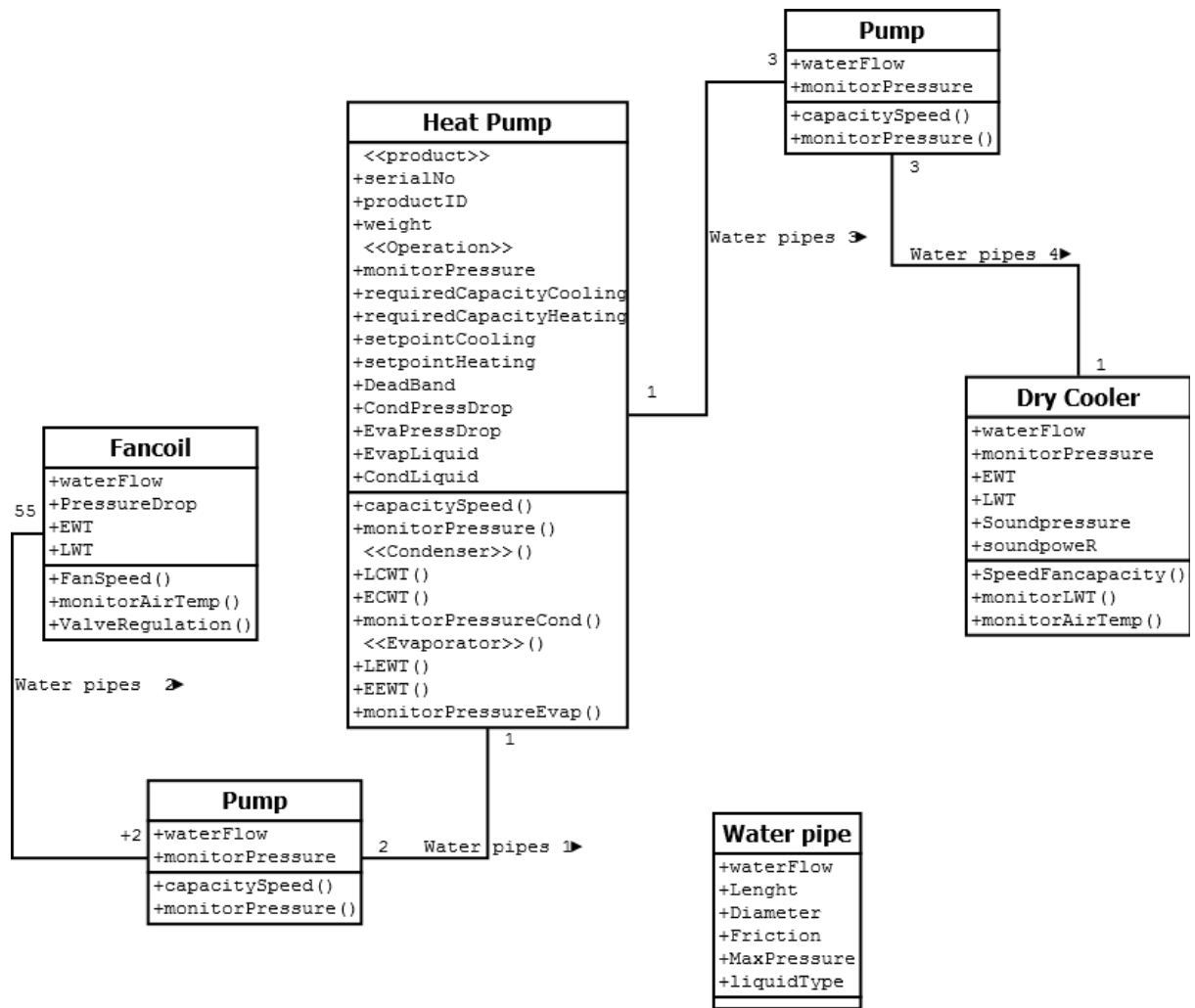

Figure ER.0: Class diagram of basic data classes of the specific part of the conceptual scheme of cooling system. Product (default) objects shows data attribute on the more detail level. source : Diaportable graph design

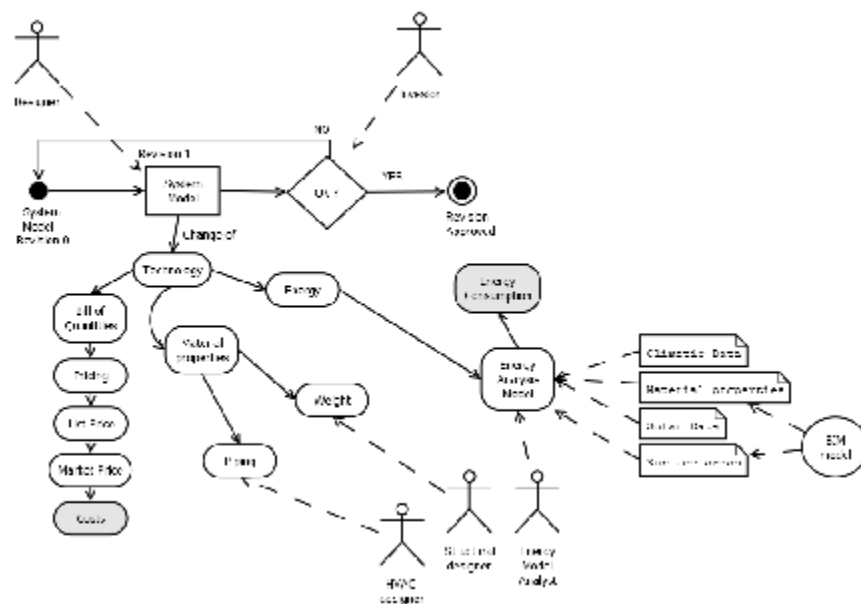

Figure S.1: Description of never-ending building (parts) revision process and its possible impacts to other professions. Gray data are measured project data change which is interesting Investor considerations and decisions, from two specified, Costs are more important , source : Diaportable graph design

Drafting the concept of cloud application

An application, better told an informational system based on cloud platform (IS), will be focused to an effective workspace platform for fulfillment construction process participants work duties. What is the difference between this IS and already available BIM modeling processes ? IS platform will fork mainly with IFC objects, which is open data exchange platform for many of commercial BIM designing softwares. BIM model of building or construction is result of designer's and investor's mutual decisions based on existing informations and commercial factors involving these decisions.

Main aim of this IS platform is to help decisionmakers to fasten and improve their decisions by IFC objects management, automated selection of objects during tender and design phases and by lowering the bad decisions threats..

IFC data model is an object-oriented data model based on class definitions representing things such as dynamic properties, shapes, elements and are used by different software programs for construction plan and facility management project. The aim of my work also develops concept for Industrial manufacturer utilization of IFC with deeper collaboration with Designer. As IFC format is focusing more to information classes needed mostly for sharing its informations and less to use and activate inside elements or processes, the designed IS in this work will be ready for different data processing from the IFC data packages (or IFC objects).

Application will be operating on desktop platforms and notebooks, tablets or smartphones using touch panels in the basic principle terminal = cloud system. The possibility to work offline will be prepared for specified functions, which upload and download data when terminal is online.

For whom shall be IS for ?

Application will be prepared to enhance efficiency of cooperation of subjects working in construction industry as well as to enhance efficiency of the product used for construction, manufactured by industry. Each object delivered, installed and used/operated on site will be considered as industrial product, which has its own life cycle, begin in research and development dept. (R&D), born in manufacture process, transported to site, installed, used, replaced by newer and/or destructed.

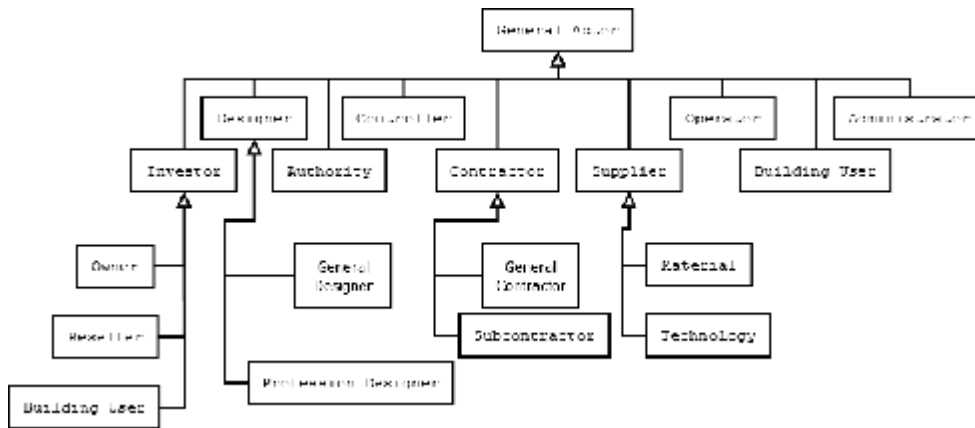

Figure G.1 - User (actor) specification : 1st. level, source : Diaportable graph design

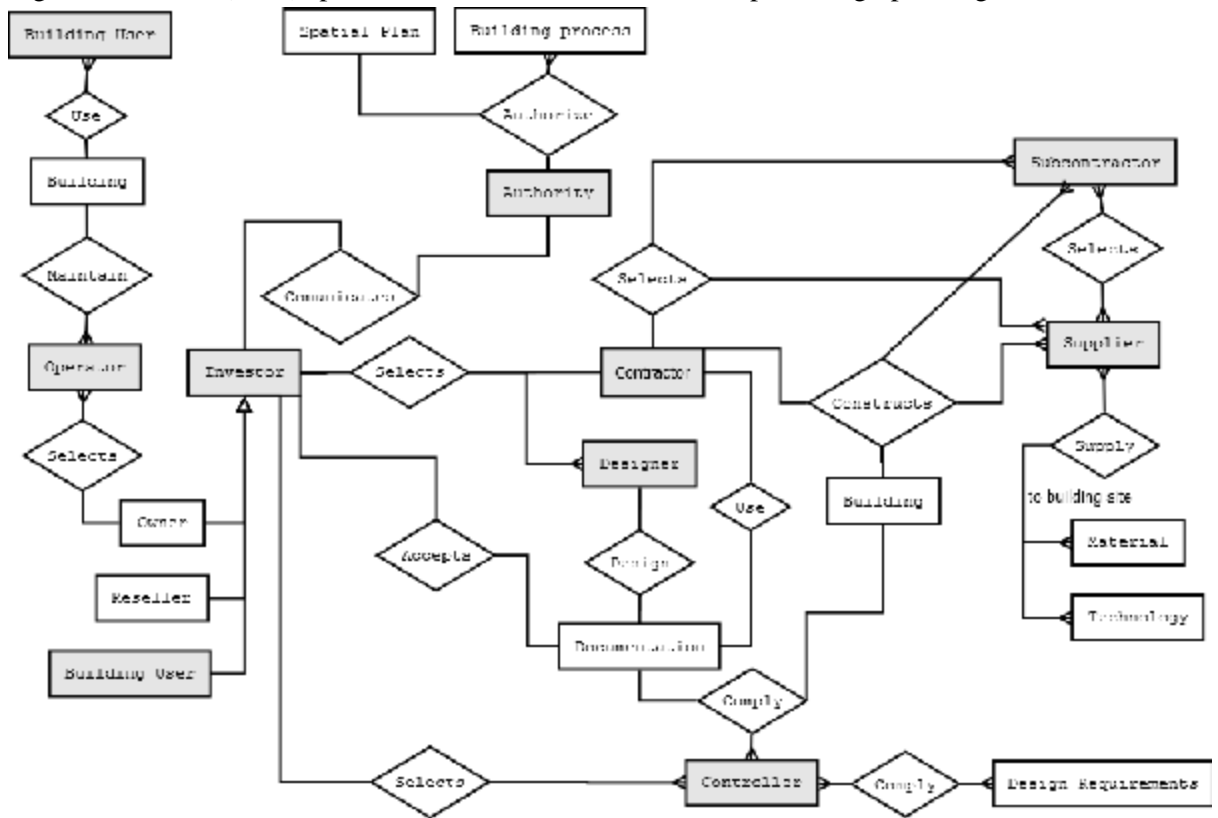

Figure C.1d : Entity Relationship diagram of main roles in the building process and their possible interactions, source : Diaportable graph design

Application requirements

1. System will have created database for storing the informations according characteristic and structure defined in the next development process. Data will have characteristic to save the cognitive relations inbetween each other as well as possibility to graphically describe their relations. After data query as input to database, list of possible data, available in accordance to filter setting, will be shown.

- a. Database will be recording all the inputs of data queries nationwide. The reason is to specify and monitor possible demands of specific informations over time. These statistic data can further be used for Business Intelligence management for specific participants of construction process.
2. System will be able to show any of mentioned kinds of informations : text, BIM model, IFC model, 2D graphics information.
3. System will be distinguishing the User roles (Actor roles) access rights to specific databases and services. Systems could increase and decrease specific access rights of specific users defined by actor role according competences and terms and conditions of system.
4. System allows to give more types of access rights to one user.
5. System allows to create, update and modify (in specific circumstances also delete) informations in the system database.
 - a. System allow deleting of informations in standard conditions only if it was new information cell without specific information (empty)
 - b. For deleting some already used information will be provided specific process.
6. System will provide list of the users provided by specific query in the search filter.
 - a. The user´s activity will be able to monitor also with specific query filters - service for specific users only available
7. Application provide to define a process and include in it the actor roles and their competences and roles in it.
 - a. Application is able to create specific conversation tree and list with history between actors during any specified process
 - b. Conversations and the results of the process is then stored in database
 - c. Process can be repeated over time and next approval process result will be stored with new timestamp.
 - d. Modifying and deleting processes informations will be possible under specific circumstances.
 - e. processes
 - i. approval process
 - ii. control process
 - iii. activity process
 - f. each process has to have defined specific states
 - g. Application will be allocating the creator and receiver of process, together joined with specific project
 - h. projects can be merged, divided and enhanced
 - i. System allows to specify processes thus project development over the time. Notifications, countdown timers, reminders will be possible to apply to any process.
 - j. System allows to add additional sub-processes to each process with same creating and modifying rules as processes has.

- k. System is monitoring the state of each process
8. Application is monitoring, as well as database system is, activity of users.

Further requirements

1. Data transaction over network possibility to secure with 128-bit encryption.
2. Aim to fast response time of system : Upper limit of server's reaction to client's request is 300 ms maximum during peak operation duty of system. Variable inputs are operation duty maximum and maximum internet connection speed.
3. Ability of scaling hardware provided for IS on behalf of the IS actual hardware demand (computational demand) based on actual number of users connected. System shall be prepared to scale-up its potential for possibility to serve thousands of users in moment.
 - a. specific minimum limits of number of connections will be set as basic standard for system
4. Securing of personal data of individuals
5. License - user has right to use potential of IS. He does not have the right to do any modifications on the level of source code anyhow according his needs. This prohibition shall be protected by law.
6. Modules for IS placed in specific client's servers are possible to install at one server + at least one backup server.
7. Data security - all sensitive client's data can be stored at IS located at company's location, where can be accessed only by local network computers. Client will be deciding, whether specific data will be in the state "public" or not.
8. System scalability

Future changing and enhancing the system possibilities

As mentioned in the comment about RUP development, system needs to be prepared for its future change, extension and modification. Giving the system the compatibility to possible hardware scalability, giving it robustness and ability to change its parts for updated one is crucial for system ability to react to the change of demand. Graphical interfaces for the terminal platforms will be separate matter of enhancing and improving and shall be independent in its update versions from the functionalities and their updates.

Interface of system

The user interface (UI) of the system will vary depend on the platform on which will be offered to use the systems. Most common platforms as windows computers will

be served with highest priority. System Will be offered on the basis of the cloud connected terminal throughout web browser. Main reason for terminal connection to the cloud is the most of data and functions user will use cannot be stored in the software locally installed because concept discrepancy.

Safety

Safety of the system may be considered from the scope of safe and valid computational processes which gives safety for final decisions made with their help[24]. Another view may be the safety of the user's sensitive data leakage. Especially industrial manufacturers will keep their specific technical data out of the cloud system if it will not be trustworthy to their private knowledge property.

System will so shall offer besides hiding possibility of specific imported data from the "public" space, away from the eyes of competitors also to encrypt data. Good pattern is the way of encrypting data by Google in gmail services.

The IS is having a role which can be for especially manufacturer users determined as Outsourcing service. Outsourcing may be problematic especially in the matter of supporting big players with big turnovers which can face in real risks from the system failure. Each company and potential user of the system will anyway shall evaluate his risks caused by the using the system [26].

Actor roles division

Roles within the construction industry sector i did divided into these basic groups :

1. Investor (I)
2. Designer (D)
3. Authority (A)
4. Controller (Con)
5. Contractor (Ctr)
6. Supplier / Industrial manufacturer (S/M)
7. Operator (O)
8. User (U)
9. Administrator (Ad)
10. Agent (Ag)

Activities and Activity Scenarios of users

Activities (or processes), activity scenarios (or processes scenarios, or, processes variants) will be divided between main Actor roles and their demands.

Processes (functionality demands) as determinants of “Decision-support” applications. Mathematically based functions which are determined for specific short range or long range data processing.

General Actor (G)

This role will state basic specifications of each user of system, where all necessary data as name, contact, phone number will be specified. Decision-making rights in decisionmaking processes (function of General Actor) will also need to be specified, thus Actor can be in the project specified whether *decisionmaker, applicant or executor* from the point of view of decision processes status as seen in Figure MC.1. these statuses can be different for each *Approval process* specified in IS.

Other Attributes of building participant, as planning process phase, construction process phase will be specified. It can be possible for example, that one specific designer will be signed as decision-maker and designer of all design phases in the project.

These mutual functions and operations are valid for all actors and are inherited down within the class structure of actors.

General Actor’s Mutual Activities :

1. Approval Process
 - a. Verifying the applicants authorisation for the process Application
 - b. Check the application documentation and its accordance with Legal and Technical regulations
 - c. Process Initiation - Application
2. Search function
 - a. search exactly specified data in the manner of the time, sources, forms, technical matter, occurrences and statistical outcomes
3. Communication - Group and Individual
 - a. writeMessageTo
 - b. receiveMessage
 - c. send
4. Compare processes and data
 - a. Compare : based upon specific comparable properties according each Actor’ s specification
5. Tag information
 - a. Tag : marks informations by some way : like / dislike, ontology connections, important, etc.
6. Voting processes
 - a. possibility to vote whether within working group or publically

7. Embedded Applications and Agent Solver usage
 - a. preparation for widely grown different automatic and semi-automatic functions for help to daily Actor' s duties
8. Management data
 - a. data management and categorisation such as Budget preparation, or client management - management in tables - Bill of Quantities Management
 - b. edit IFC objects data
 - c. BoQ (data) edit consisted from functions :
 - i. search, createNew, Edit, Delete, send ..
 - ii. chronology settings of tables and rows/columns within tables
 - iii. pivot tables function known from excel implementation
 - iv. product anonymisation for Tendering
 - v. preparation (tables)
 - d. Data import and export to different file format types
 - i. BIM / IFC model
 - ii. BoQ tables
9. Monitor Processes
 - a. monitor process monitoring and storing the processes development
 - b. check compliance of specific data (terms and conditions according contract, compliance with law, technical regulations...)
 - c. monitor deadlines of processes
 - d. monitor and store operation data of existing systems (compliance with communicating protocols)
10. Tendering
 - a. Search tender possibility on the markets
 - b. Prepare and apply Tender proposals
 - c. Update Tender proposals
 - d. Preparing Tender announcements

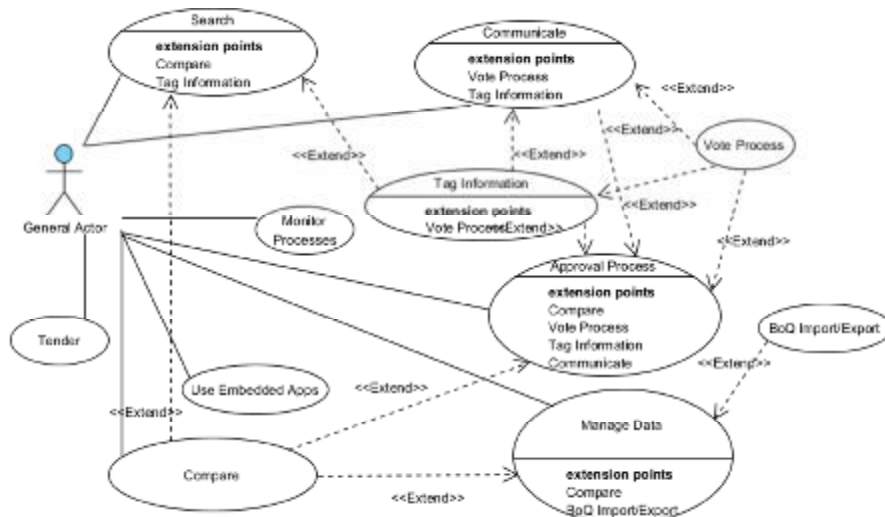

Figures U.1 and U.1.b: Use case diagram for general actor, source : Diaportable graph design

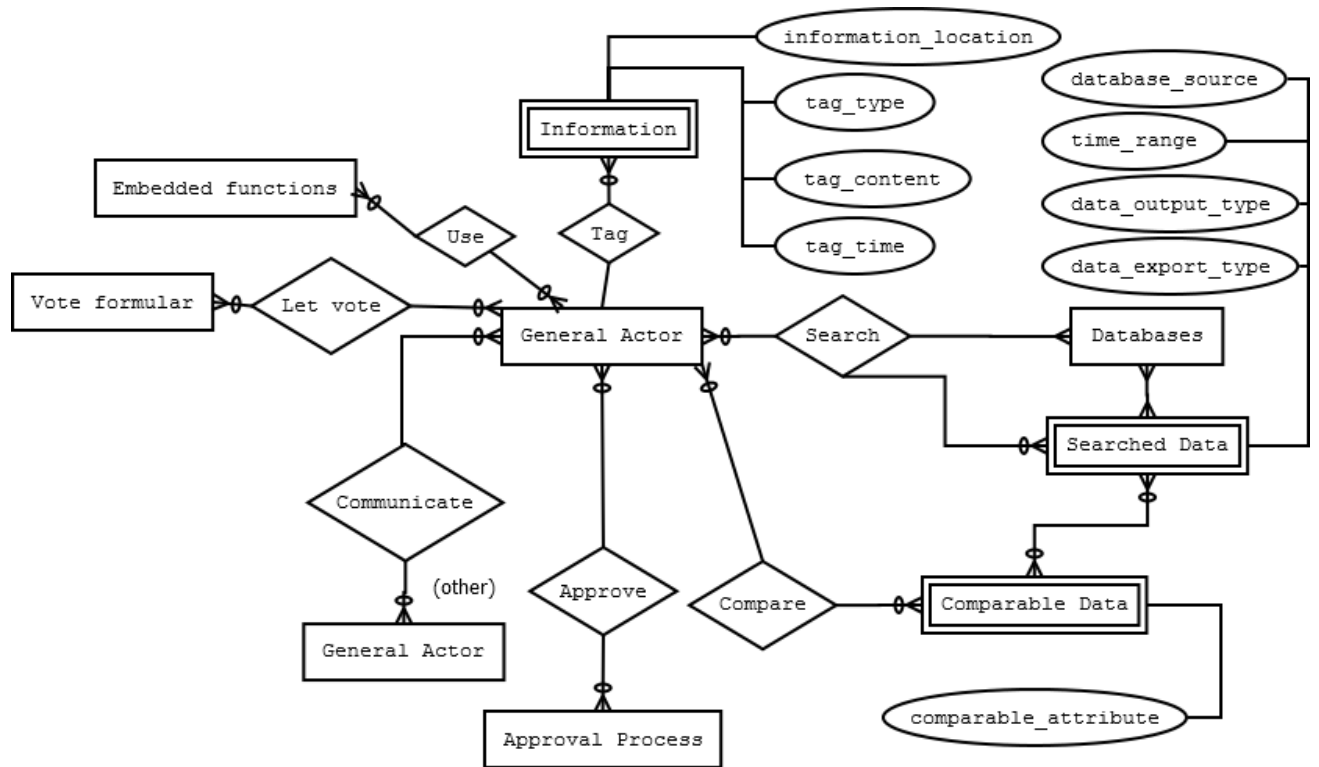

Figures ER.0b: Entity Relationship diagram for general actor, source : Diaportable graph design

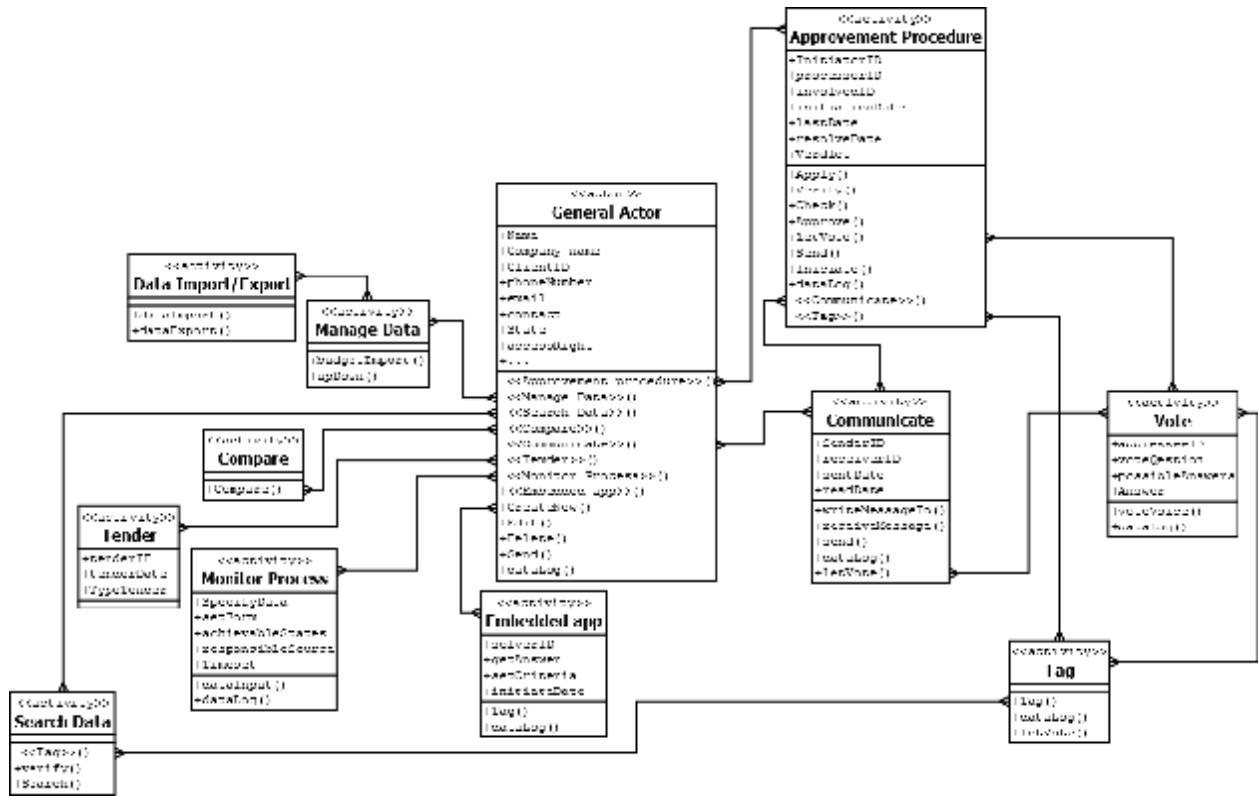

Figure C.1b : Class Diagram with basic descriptions of the actor and his functions as the structure of data flow. Each object, whether actor or his activity has specific data Attributes which needs to be stored in database to record activity and their results for big data evaluations, source : Diaportable graph design

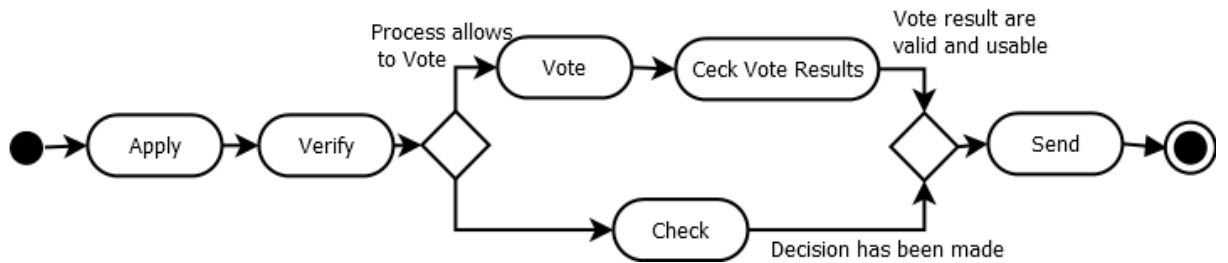

Figure A.2: Activity diagram of aprovement procedure (General), without and with decision possibility by voting within working group. Aprovement procedure is more specified for the Authority utilization in Authority roles and functions -Au_UC001- Administration Approval Process, which is slightly more extended. Source : Diaportable graph design

Approval Process G_UC000

- Use case name : Approval Process (Aprovement procedure)
- Use case Identification : G_UC000
- Actor : General Actor
- Restrictions : Actor is not logged in system
Other functions cannot run in main screen (background only);
Actor is not authorised for specific process application

=====

Approval process is one of the most used process within the IS. In Construction Industry, almost each step is controlled and approved by someone. General approval process is after extended within the competencies of Authority actor which will be specified in the activity Au_UC001 description. Approval process answers the questions : Are criteria specified by decisionmaker in compliance of reality ? Or is expected state in compliance with criteria set ? Who can approve/reject control ? Why ? When it shall be done so ? Are all materials prepared for approval prepared and correct ? Who is expecting an answer ? Do decisionmaker needs to notify someone else before final decision or ask his/her statement or “sub-decision” ?

Each approval process shall have preset expected results, which may not be only *Approved, Rejected, or Approved with objection.*

Approval processes will be usable between business partners with their specific roles, rights and duties as well as within one working group team.

User only specify *what* shall be decided (specify exact question or select ready-made decision-process from the list) *by whom, till when* , attach necessary attachments or text documentation, or data and send request for decision (or application).

For the processing of the administrative aprovement processes required by local law regulations the IS will automatically shall remind the necessity of start and finish each process to all of involved participants. According the pre-prepared structure and harmonogram of the administrative processes.

=====

No.	Actor	Activity	Condition
1	User (Applicant)	Login (self define as type of Actor)	
2	User (Applicant)	Select Procedure Approval process type from the list available (according Actor role)	
2.1	User (Applicant)	If there is uncertainty or need of use not prespecified process, User will determine <i>what</i> shall be decided (specify exact question) <i>by whom, till when</i> (deadline and notifications specification), attach necessary attachments or text documentation,	Procedure does not have specified approval process within the list
2.2	System	System offers saving the new created process into personal/group/public templates list	
3	User (Applicant)	Check whether all materials and attachments necessary for the process are prepared and attach them	
4	System	Shows list of necessary materials with checked	

		marks on prepared documents, red marked are non prepared	
5	User (Applicant)	Select procedure for apply, apply for procedural process	Procedure has to have all necessary documents prepared
6.1	System	Verify actor's authorisation for the process application	application process has to have request of Applicants verification
6.2	System	Send an application to all selected participants (decision makers and announced) of procedure, inform all participants about dead-line date of the procedure needed to be finished, inform them about aims of procedure, offer participants communicate together within <i>communication</i> function, system stores communication history	Applicant is verified; Procedure has to have all necessary documents prepared
6.3	System	Send process decision model as <i>vote</i> function to predefined users, or informational places (i.e. web pages banners)	Approval process is set for <i>vote</i> function
7	Users (evaluators)	Participants receives process application, coordinate together via <i>communication</i> function, check compliance documents attachments with technical and legal regulations	
8	Users (evaluators)	Decide Approve/Reject status according their competencies, send standpoint to Applicant	
8.1.1	Users (evaluators)	Evaluator sends <i>Another Institution Request A_UC002</i> for statement/action/decision to different institution involved in the approval process	decision process cannot be finished without specific action or statement or decision of other institution or other person within same institution
8.1.2	System	System accepts the request sends it and awaits for the answer(s). In the specified times it will send also notification reminders to requested participants	
8.2	Users (evaluators)	Authorised user can offer decision right to other specific users for decide Approve/Reject decision by <i>vote</i> function	User is authorised for send <i>vote</i> function
8.3	System	System offers possibility of <i>compare</i> function for	

		comparing specific attachments or information in application with similar data (set by <i>Search information</i> , or <i>Tag</i> data), also offers <i>Tag</i> specific information or <i>communicate</i> with other specific Users	
9.1	System	Sends reminder notifications for finalising the approval procedure in specified harmonogram	approval procedure is not finished till specified harmonogram (i.e. 5 days before deadline)
9.2	System	Sends standpoint from evaluators to Applicant System stores the process results, dates and document in database	Evaluators has their standpoints prepared

Search for information G_UC001

Use case name : Search for information
 Use case Identification : G_UC001
 Actor : General Actor
 Restrictions : Actor is not authorised in the system / database;
 Actor is not logged in system

=====

Search for informations is one of the most important functions in the system because of the necessity to always have informations on time, when needed and with appropriate quality value. These informations will be the building bricks for all building process participants which will give to them higher performance - such as faster work, higher revenues, enforcement of better products at the market.

Informations shall be searched from databases stored in the data storage of system and will be continuously growing over time. Available data will be accordance the philosophy of the different kinds of “points of view” - conceptual : concepts libraries, technical: product technical data databases, In longer range of the databases use, where it will grows-up to volume and contents, logistic-organisational-management : data about product manufacture, carbon feet , etc., economic : data about energy prices, data from financial markets, price data about technical product, theoretical : data for possible sustainable development project, etc.

Data will be either created straight by users and stored into database or will be automatically “harvested” by programmed agents created to do so or by API application created for linking data sources from external networks and storing data continuously in own databases.

Databases can after gaining appropriate volume of data offer very interesting tool of “fast feedback” giving the system conclusions from the searched types of

informations in the search interface. The spectrum of searched specified types of data can predict change in market. Google for example has experience with obtaining indications of cold epidemic sooner, than clinics and medical treatment centres, simply because during first epidemic waves people rather google informations about fast self-cure than visit doctor.

Databases will contain structured data necessary for all planning object phases processes. Search function will allow user to search data by two basic ways. First will be search data by exact writing within search window. For this searching will be possible to use specific syntax based on Boolean logic. Of course for this way for data search will user have to have good knowledge of the syntax.

Second data search specification will be more simple for daily use of user within construction industry. Search data is divided into four steps where in first step in *library selection table* you specify data library source (all or some), then you specify time range of data creation (or modification), in third step in *Pre-selection table* you specify specific data (specific products, technical properties, conceptual templates:groups of unspecified products, realized installations, price data, etc.) with searching specific source by search sub-windows in the table. Each sub-search (or data determination) will be another row below the main data source row in the table, in the root structure. Then You specify, which data you want to forward to *Detailed selection table* (table thus can be multiplied into more tabs and be saved-loaded into-from the template library). Fourth step is data form and content specification into specific data export - numerical (tables, matrixes) or graphic (2D graphs, 3D Graphs, their multiple combinations) and their forwarding to data export.

Numerical data export shall work similarly as the function of data management of pivot tables in excel and extended into 3D data matrixes.

Graphical export you specify by forwarding specific data from *Detailed selection table* into the specific (X, Y, and Z axes) axis in the graph. It is possible to set more than one axis in one "side" to have different data type in the same dimension, for example temperature and efficiency ratio in the Y axis in 2D graph. Each data shown in graph shall have its own scale, minimum and maximum value setting possibilities. Deeper description with graphical wireframe You will find below G_UC001 Wireframe Concept Description with Figure WF.01.

Data libraries utilization probability of specific IS users (Actors)

	(I)	(D)	(A)	(Con)	(Ctr)	(S/M)	(O)	(U)	(Ad)	(Ag)
<i>technical data libraries</i>										
Climatic data		x			x		x		x	x
Systems concepts template	x	x		x	x	x			x	x
Geology data		x				x			x	
Products technical data	x	x		x	x	x	x		x	x
<i>Installed applications libraries</i>										
technical regulations library		x	x		x		x		x	x
legal regulations library		x	x		x		x		x	x
Installation faults library		x			x		x		x	x
operation data libraries	x	x			x	x	x		x	x
experience libraries	x	x			x	x	x	x	x	x
interior quality data	x	x	x	x	x	x	x	x	x	x
<i>Multi-scale design libraries</i>										
GIS databases	x	x	x						x	x
Spatial plans databases	x	x	x						x	x
<i>Economic libraries</i>										
Products prices		x			x	x	x		x	x
Energy prices data	x	x			x	x	x		x	x
Money market databases	x	x							x	x
Financial derivatives prices databases	x								x	x

Figure D.0 : Basic division of data library classes and their usage between different Actor roles in process. Databases are now market as X which is actually meant as “high usage” but over time You can simply see statistical data in numbers as result of Big Data analysis procedure

Within *Products technical data libraries*, specific product attributes can be searched with the products together. Attributes of products can be divided into more basic groups, such *physical, mechanical, electrical, manufacture, economic* properties (or attributes, which name You like more). Reasons and necessity to determine and ability for finding them by search function are mentioned in the Designer’s function Conceptual Design D_UC001 on the description text of Designer’s functions in text more below.

=====

No.	Actor	Activity	Condition
1	User	User Log into Search profile	User is authorised and logged into IS
2	System	Offer available databases for specify and search in (examples of databases described in the function description above use case table)	

3	User	Specify databases to use for search (specific or all).	Specified databases exist
3.1	System	System will ask for filling the time range of data for search. If the search was not done in the working process for the first time, offer the last time settings for fasten the selection	Time range exists
3.2	User	User will set time criteria (<i>from, to, or actual time</i>)	
4.1	System	System will transfer specified data libraries into <i>Pre-selection</i> table and wait for further specification of user.	
4.2	User	User will determine data details in the table to specify and filter the data. Specification will be done via filter windows in each row on the table (with “search” logo). User also marks specified data for further forwarding to <i>Detailed selection</i> table.	specification criteria are searchable and exists
4.3	System	System is able to do traditional support functions such as undo/redo step, save the selection filtering inputs to specific template	
5.1	System	System transfers data to <i>Detailed selection</i> table and offers data selection specified content and form from filtered data and offers to forward them to either for X, Y, Z axes for graphical projection or data to rows and tables for table visualization (pivot tables)	
5.2	User	User specify and forward data for export to specific axes/rows/columns and elaborate results	
5.3	User	System offer tag specific informations from search with specific comment by function <i>Tag information</i> , or use <i>compare</i> function for selected data with similar data,	Function is required to use by the user
5.4	System	System is able to save the search result or search data template for further personal/working group/public use.	User wants to store data selection template or results
6.1	System	System stores dataLog activity and results of user’s selection to database	

6.2	System	System show (graphical or table) results to User, System is able to offer export data for user in common formats (i.e. csv filetype) and forward the search data for further work with other functions	
-----	--------	--	--

Case study G_UC001 (1) of Search for information function :

Case study scenario : Let's say designer needs to evaluate impact of BIM model of already constructed administration building in different climate environment, due to use building model as standard template for another project, where will be evaluated impacts of different temperatures and solar radiation to *cooling demand* of building. Outside envelope ratio windows/facades, shading devices and internal maximum cooling capacity will thus be variables of this main input, which will be searched and evaluated.

Aim : Search for the closest climate data from building project from the last year in the range of *Dry Bulb temperature, Humidity, Solar irradiance*

second aim example: Search for the closest climate data from building project, **estimate its trend over last decade (increasing ? decreasing ?)** in the range of *Dry Bulb temperature, Humidity, Solar irradiance*

Search inputs :

Database : *Climate data Library*

Time : *since 01/08/2015 till 01/08/2014*

(other alternative of search : 01/08/2015 till 01/08/2005)

Quality data type : DryBulbTemp, relative Humidity, Direct solar radiation

Quantity data type 1: hourly data

Quantity data type 2: trend of day average temperature/Humidity/Direct solar radiation over 10 years

Quantity data type 3: cumulative values over year

Graphical export 1:

axes :

X = daytime (24 hours);

Y= year time (365 days);

Z(vertical)= Quality data : DryBulbTemp, relative Humidity, Irradiation

getLibrary:climateLibrary

getData: DryBulbTemp, Rhumidity, Direct solar radiation

timeFrom: 01/08/2015

timeTo: 01/08/2015

plotData: plotX:hourTime; plotY:yearDays; plotZ:DryBulbTemp/Rhumidity/dirRad

Data export :

columns : Quality data : DryBulbTemp, Humidity, Direct solar radiation, date, weekday, bank-holidays (Boolean)

rows : year hours (8760 hours)

Graphical export of Case study 01:

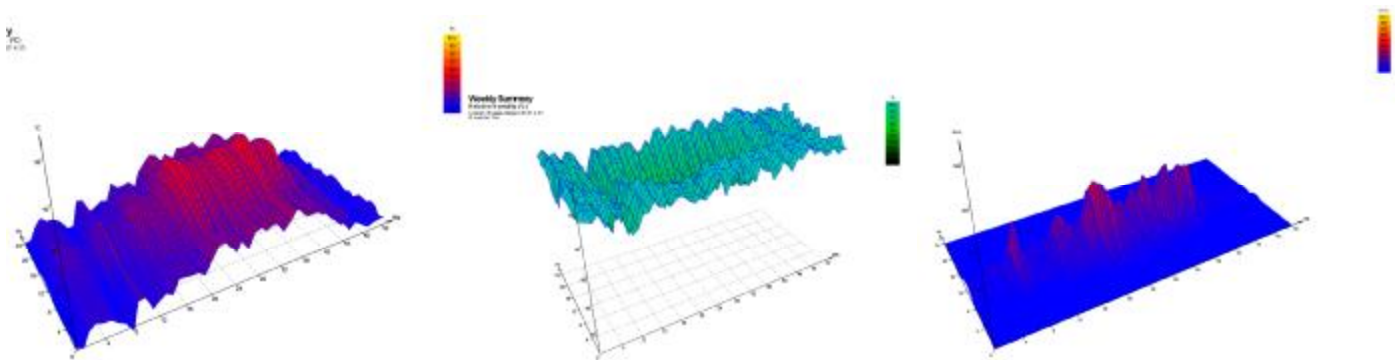

Figure D.1 : examples of a Graphical results from function search, searching climatic data, possible package template for more of such specified climate data, source: Ecotect Analysis, Weather Tool, 2011 Autodesk

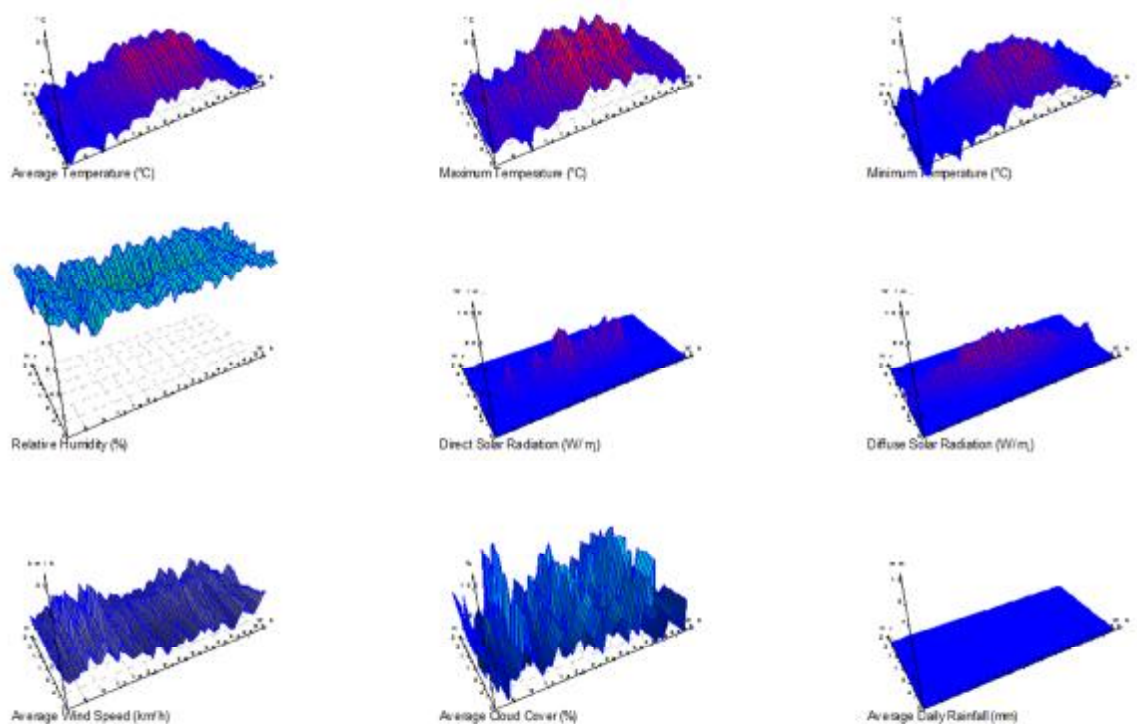

Figure D.2 :possible package template for more of such specified climate data, source: Ecotect Analysis, Weather Tool, 2011 Autodesk

Conclusion of Case study (1) G_UC001 :

Around climatic data can be built-up another applications or another search data to where this climate data search will be just first step. With BaS concept creation module ((applications for specification of HVAC systems control and operation) these climatic data will be graphical basement for hvac concept system design hand in hand with its control.

For example, evaluation for selection cooling system with ice accumulation comparing with second variant of water chiller with roof condenser. Evaluation both of system shall have already clear timing and operation schedule all year long with its energy consumption evaluation, investment costs . For ice accumulation cooling system would be frankly interesting to search also price of electricity and its changes over period in past in the location because system is efficiently “charging” over night time where can be night price electricity tariffs important for this variant to be realized. Lower investment costs because of smaller maximum cooling capacity of chiller will be wise to evaluate and consider also. Second cooling system would be interesting because possibility to use chiller with higher efficiency on part-loads and use variable speed compressors, variable speed fans at condenser with variable condensing pressure possible by PID regulation.

Direct solar radiation data can be then for example used with combination of building model with neighbor models in its surrounding for evaluation of facade solar gains and design of shading devices on facades with taking into account shading by surrounding buildings. Shading devices are cheapest way how to decrease cooling demand in building for lowering its operating costs thus life cycle costs. This is very often required evaluation between designers.

This solar radiation evaluation of facades could be also part of the IS as an *embedded application* for usage.

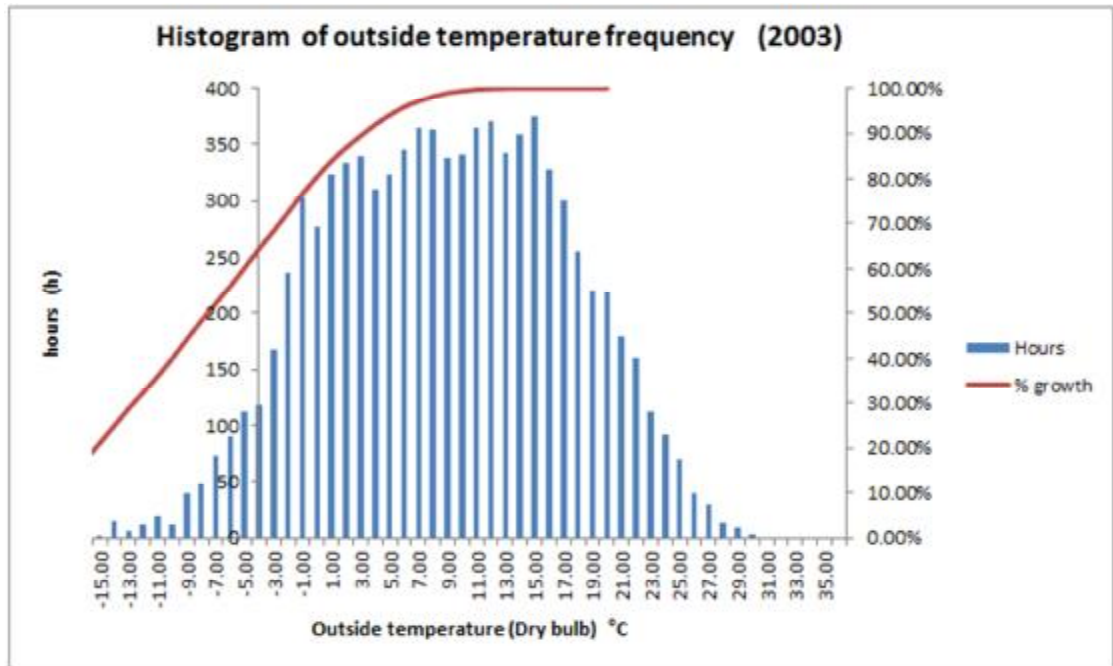

Figure D.3 : Cumulative times of outside temperature graph. Source : own excel design

Cumulative data of specific temperature frequency over year period (mostly considered as average hourly value, but can be used also peak - maximum values) are often used instead of hourly temperature data for fast computation of specific system energy consumption, no matter, whether it is ventilation, boiler consumption, cooling system etc.

Procedure of possible creation and usage of such data are described in the wireframe of search function description in the text below.

Case study G_UC001 No.2 of Search for information function :

Case study scenario : Let's say manufacturer of condensing heating boilers wants to sell these products in the specific market where his product competes with less expensive but less efficient atmospheric boiler. Let's say, this market is not in the Czech Republic because here these less efficient boilers will not be possible to buy and install since 2016 but for example China, which is huge market, or another country where can be reasonable to pus selling these products. Condensing boiler saves energy by its efficiency higher than 100 % , nominal values reach 109 % but as you can see in Figure D.4 , efficiency is not only one nominal value but non-linear curve (frankly linear curves are stated in graph but this is just simple model) where input variable influencing efficiency is boiler power capacity and temperature difference (gradient) of heated water outlet-inlet as well. To compare these efficiency with "competitor" product, atmospheric boiler has always efficiency 92 - 94 % . That basically can for final user means, that with first product you earn (or save) approximately 9 coins from each hundred coins You will pay for the gas. With second type of boiler for each hundred coins You buy gas, You utilize for yourself only 92. So that is in one case 9 coins in

plus and in second case eight crowns minus. Total difference is 17 crowns! This can be for the seller of the condensing boiler seller very strong argument for motivate potential buyers for obtaining higher capital or arranging bank loan for buying this more expensive but more valuable utility.

Manufacturer can prepare database objects (or IFC objects) for having it

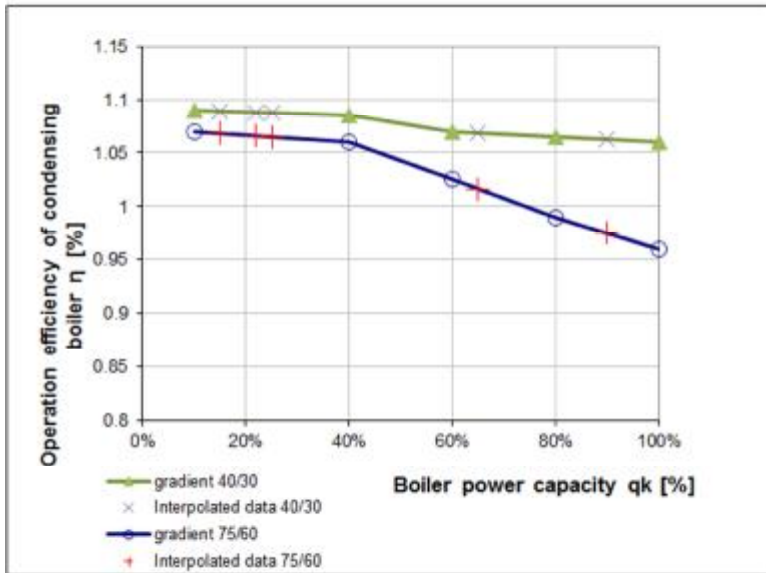

available for potential customers, or customer's designers in the IS cloud. Manufacturer could even offer computation model where potential user after input necessary data can see the amount of money saving and its ROI - Return Of Investment. In Figure D.4 are visible grey crosses and red plus marks which are interpolated values of the efficiency curves for fast-computation and evaluation of such product installation.

Figure D.4 : Condensing Boiler efficiency graph. Two efficiency curves according two different temperature gradient sets. Source : own excel design

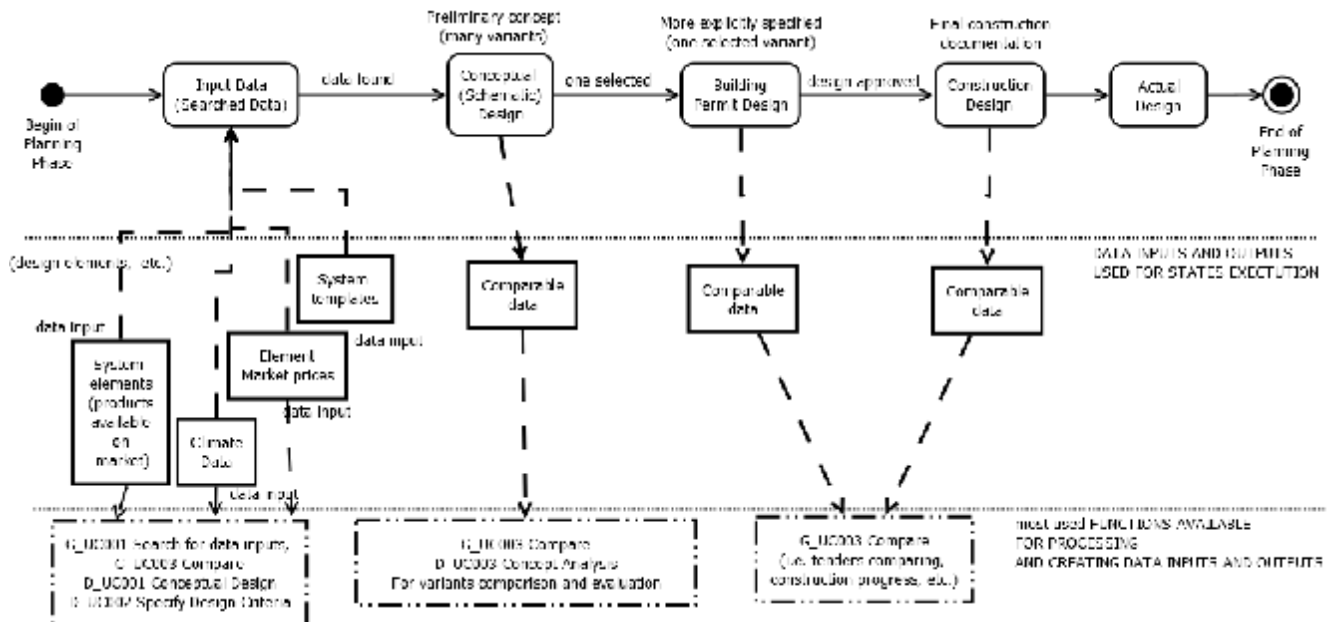

Figure SD.3b : State diagram of project evolution and its connection to search and compare functions throughout design phases, source : Diaportable graph design

Conclusion of Case study (2) G_UC001 : In this study case can designer or potential small investor search in database data of condensing boilers and forward searched data of its price and efficiency for further estimation whether he will or will not use it for its design/investment.

Case study G_UC001 No.3 of Search for information function:

Case study scenario : Let’s imagine that design controller, whether is it an Authority official or Investor’s depute need to control design according technical or legal regulations. He will have the possibility to search in text database, where he can find specific technical/law rule according to with shall be the controlled design in compliance with. He then will have the possibility to accept/reject the design part and step for further checking of design.

Does system element has acceptable level of acoustic noise in **internal** environment ?
=> search: acoustic limits => compare law regulations with designed value

Does system element has acceptable level of acoustic noise in **external** environment ?
=> search: acoustic limits => compare law regulations with designed value

In these procedure will be also useful function *Tag information* if necessary, with further comment how to solve potential design failures.

Text databases thus shall have more specific data structure which i will describe more in different part of this work.

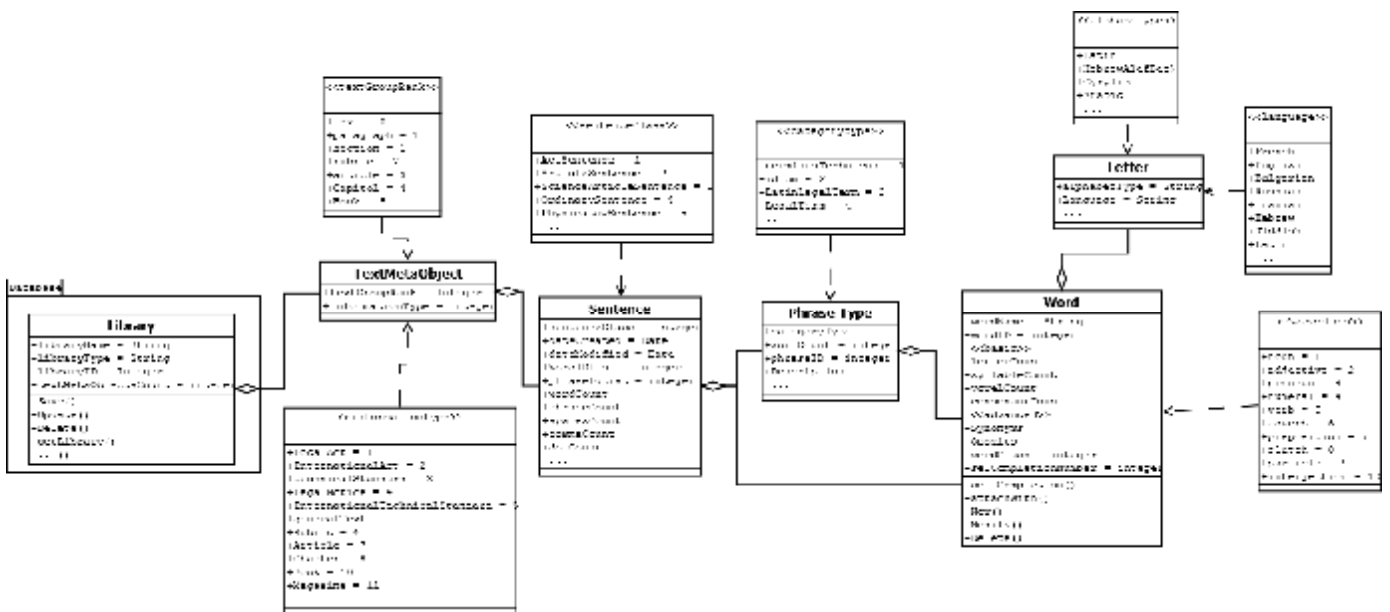

Figure C.01 : Class diagram example of Text data object class structure for the search function, source : Diaportable graph design

G_UC001 Wireframe concept Description

On Figure above You can see specific drawn wireframe of the Search function page. Search page, as already mentioned, is one of the most important and commonly

used functions of the system. You centralize data which you select, combine, compare and use in each phase of building process. Basic search window is marked by number 2 but it is filling mostly automatically due to selecting specific informations from lower parts of screen. Its syntax logic typing straight to search window is working but user needs to gain a bit of knowledge of writing queries. Main logic of data search is based on questions : from Where to search data ? From to When shall be data looked for ? How should be data prepared for final view ? Where would be data stored or forwarded to ?

Libraries (Databases) which are stored internally, or read externally are reached and specified in the window near markers 7,8. You can simply specify to search in “all” databases (marker 6) but to fasten the searching process is possible to select specific libraries needed, by clicking “specific” on the Library selection button near marker 6 and continue down below, to *Specific Libraries*, where you can select specific set of libraries for search or create more library groups for search in another tabs (marker 7).

When You specified libraries to search in, selecting time range (or only actual present time) in the area marked by No.1 marker, whether to use sliders or calendar date selecting (hours and minutes shall be specified also if needed).

As You can see on the Figures D.1, D.2 and D.4, graphical data needs to have specified forms and places of presentation, whether are data graphically described in 2D or 3D coordinate axes, or is only necessary to show table data. If table data exists, explicit graphical explanation also will be possible. Below time specifiers in Figure WF.01 is *Pre-selection* table, where are stored selected libraries data filtered according time. You can specify data even more via exact determination the values joined with demand data and write such specifications to the second column “*Selection specifications and Restrictions*” as You can see near marker 9. For example from the row of Industrial products, where products are not specified (N/A marker on the row) You can determine products from Czech Republic in Europe by typing Europe, and specifying Czech Republic. Restrictions shall be possible to write down as well. With this selection You can see products, specifically *Cooling components* which are either Active Cooling Beams or Diffusers which are able to be bought on the Czech market (In this data selection time shall be possible to determine whether you mean Czech Republic as manufacture country or product is on the country’s market). You can see the selected list of such selection is raising 226 specific products. By the functions “Edit”, “View”, “Save” near marker 10, You can go more in depth of such selection in another window to analyze, save, send or more specify the data. With marker in column marked with number 11, You specify selected data for further evaluation. During all this preselection (and also further detailed selection) process you can use wery helpfull applications for repairing or saving Your steps by panel near number 4 and 3. The only difference between 4 and 3 is that window 3 with functions is applicable to one row and panel 4 for table as a whole.

By rolling the horizontal and vertical splitters (5) you specify and update necessary spacing between separate selection tables within a screen.

Detailed selection tab, below the pre-selection table is forwarding data from the preselection table, and is ready to prepare specific, table or graphical exports from data

sources or the combination of data sources. You specify form of data export in list (12) and select specific data source in (19) which to use as “first” *INPUT DATA* source for table/graphical evaluation. You can specify more input data sources by adding other data into area (18). In wireframe you see only climate data, average hourly temperature, which shows itself into 3D surface graph, where has day-hours specified on axis X, days (365 days) on axis Y and Temperature is shown into the height- Z axis. All of specified data forms (time form) or values (air property values) in the X,Y,Z columns (14) will be possible to select in 3D graph axes data list in (15), thus You specify what would be visible where and that’s it. Don’t expect You will find out ideal combination of data visualisation and combination for the first time. These three main steps of data search and filtering gives to the data elaboration interface its high flexibility and potential. In (13) You will see determined types of data available for specific data in row or its sub-group.

Search Data

FROM WHERE to search?

Library selection:

Specific: All

Specific Libraries:

Tab One Tab Two New

- Databases
 - Technical Data Libraries
 - Systems Concepts
 - Geology/Maps
 - Climatic Data
 - Industrial Products
 - Installed Applications Libraries
 - Outside Network Databases
 - Multi-scale Urban Planning Libraries
 - Economic Libraries
 - Product Prices
 - Energy Markets
 - Electricity
 - Natural gas
 - Gas
 - Financial Primary Markets
 - Financial Secondary Markets

Time of data:

FROM: TO:

PRE-SELECTION

Library	Selection specifications and Restrictions	Amount	Use	Actions
Systems Concepts	Q,N/A	226	<input type="checkbox"/>	Edit View Save
Heating Concepts	Q,N/A	226	<input type="checkbox"/>	Edit View Save
Cooling Concepts	Q,CooledBeamsActive;Diffusers	38	<input checked="" type="checkbox"/>	Edit View Save
Climate Data	Q,CzechRepublic;Prague	3	<input checked="" type="checkbox"/>	Edit View Save
Industrial Products	Q,N/A	63523	<input type="checkbox"/>	Edit View Save
Industrial Products	Q,Europe;CzechRepublic	4758	<input type="checkbox"/>	Edit View Save
Cooling Components	Q,CooledBeamsActive;Diffusers	226	<input checked="" type="checkbox"/>	Edit View Save
Installed App Libraries	Q,CooledBeamsActive;Diffusers;CzechRepublic	3	<input checked="" type="checkbox"/>	Edit View Save
Outside Network Databases	Q,N/A	326283	<input type="checkbox"/>	Edit View Save
Energy Markets	Q,N/A	54	<input type="checkbox"/>	Edit View Save
Electricity	Q,Prague;All	12	<input checked="" type="checkbox"/>	Edit View Save

DETAILED SELECTION

1 2 New

1/ INPUT DATA

Climate Data	Note	Amount	X	Y	Z	Actions
Climate Data	hourly;daily;weekly;monthly;...		<input checked="" type="checkbox"/>	<input type="checkbox"/>	<input type="checkbox"/>	Edit View Save
Hourly - day		24	<input type="checkbox"/>	<input type="checkbox"/>	<input type="checkbox"/>	Edit View Save
Hourly		8790	<input type="checkbox"/>	<input type="checkbox"/>	<input type="checkbox"/>	Edit View Save
Daily		365	<input type="checkbox"/>	<input checked="" type="checkbox"/>	<input type="checkbox"/>	Edit View Save
Weekly		52	<input type="checkbox"/>	<input type="checkbox"/>	<input type="checkbox"/>	Edit View Save
Monthly	sum;average;cumulative	12	<input type="checkbox"/>	<input type="checkbox"/>	<input type="checkbox"/>	Edit View Save
Hourly			<input type="checkbox"/>	<input type="checkbox"/>	<input type="checkbox"/>	
Solar Radiation			<input type="checkbox"/>	<input type="checkbox"/>	<input type="checkbox"/>	
Temperature	Average;maximum;minimum;Cumulative		<input type="checkbox"/>	<input type="checkbox"/>	<input checked="" type="checkbox"/>	Edit View Save
Average			<input type="checkbox"/>	<input type="checkbox"/>	<input type="checkbox"/>	Edit View Save
Maximum			<input type="checkbox"/>	<input type="checkbox"/>	<input type="checkbox"/>	Edit View Save
Minimum			<input type="checkbox"/>	<input type="checkbox"/>	<input type="checkbox"/>	Edit View Save
Cumulative	setValue		<input type="checkbox"/>	<input type="checkbox"/>	<input type="checkbox"/>	Edit View Save
Cloud Cover			<input type="checkbox"/>	<input type="checkbox"/>	<input type="checkbox"/>	
Daily Rainfall			<input type="checkbox"/>	<input type="checkbox"/>	<input type="checkbox"/>	

2/ INPUT DATA

3D GRAPH

Weekly Summary

axes Z: AverTemp

axes X: Hourly-day

axes Y: Daily

Send To Save Compare With Update & Compare

Figure WF.01 : Wireframe example of the Search Function, Source : Wireframe Sketcher Studio own design, graphical data from Weather Tool 2011, Ecotect Analysis 2011 software

The point is, it may not be over of data evaluation and presentation only from one data source. You can specify other data source in (18), specify their presence (14) in specific 3D graph axes data list in (15) and combine climatic data with i.e. technical efficiency data or energy pricing data or both of them. Input data tables can be multiplied as much as necessary in “one tab” (19). In another tabs You can specify different data source combinations and different data exports or just copy first tab and slightly modify it.

The problematics of data export and specification to tables shall be in accordance of data preparations for pivot tables in excel, extended to possibility to workout with 3D tables - matrixes.

In (17) You see functions for forwarding prepared informations to sending it to next possible phase (Designer D_UC001 Conceptual Design especially), saving the values and their graphical or table data, saving template of selected filters, Compare (function G_UC003).

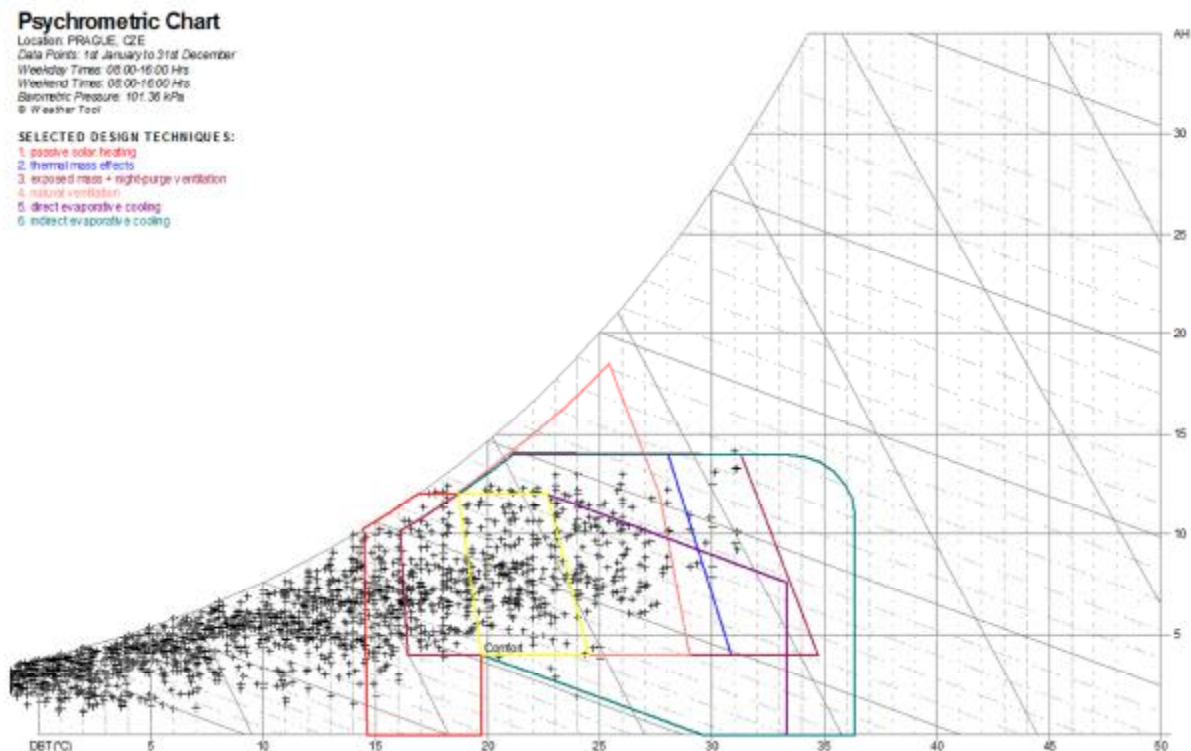

Figure D.8: Example of climatic data graphical export to Psychrometric air properties chart (black crosses marks hourly year temperature DBT) with another data types - recommended (or set) air property zones for using specific HVAC processes according figure : passive solar heating, thermal mass effects potential, exposed mass + night ventilation, natural ventilation, direct evaporative cooling, indirect evaporative cooling . Each of these processes can be implemented during design process and data provided can be good tool and documentation for supporting the design process. Source : Ecotect Analysis, Weather Tool, 2011 Autodesk

Communication function G_UC002

Use case name : Communication
 Use case Identification : G_UC002
 Actor : General Actor
 Restrictions : Actor is not logged in system

=====

Very well known function used in variable applications based on cloud today. Communication window can be opened in parallel on the front of actual work interface as well as in separate specific web page window used for discussion message threads management and archive. There shall be possibility to maintain more chat windows nearby at a time. There shall be possibility of “take” chat window from basic position and move it off the web browser to different place on desktop working space.

I must note that in specific circumstances will be necessary to provide impossibility to delete or modify specific messages, which could be sources of negotiations or issue solving between specific actors.

Communication G_UC002

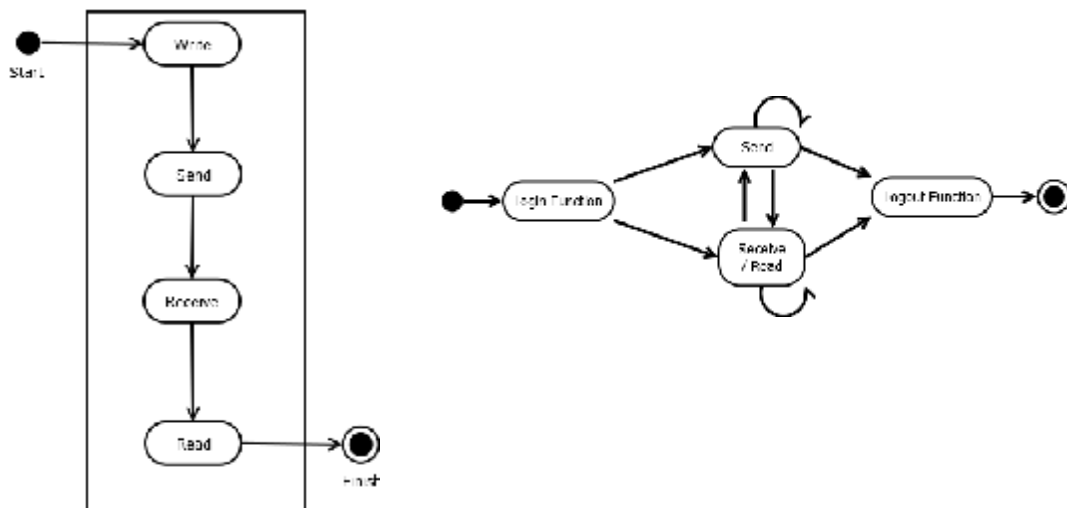

Figure A.5 : Activity diagrams of Communication function, source : Diaportable graph design, right diagram : [21]

=====

G_UC002 Communication

No.	Actor	Activity	Condition
1	User	User opens communication window	
2	System	Offer available contact list and search window	
3	User	Specify person, or persons to whom the message will be written	
4.1	User	Write message and attach possible	

		attachments or printscreens	
4.2	User	Send message with attachments	
5	System	Accept message and send it to the addresses	
5.1	System	Store message to archive, with list of addresses, attachments, with timestamp	
6	System	Notify addresses about message delivered	
6.1	Users	Users tag specific information with specific comment by function <i>Tag information</i>	Function is required by the user

Compare function G_UC003

Use case name : Compare
 Use case Identification : G_UC003
 Actor : General Actor
 Restrictions : Actor is not logged in system

=====

This function will help to compare all kind of possible comparable data within the whole lifecycle of project occurred in the IS. It is necessary only to specify data sources and specify data elements which shall be compared. Compare function is also possible to start also with by right-mouse click after specific data is selected with mouse single click or group click. If compare data will be then selected, and data will be comparable somehow (system can determine and select data to compare with or User can manually select data to compare them. Of course system will not be possible to compare weight value in kg of product with P/E ratio of Apple shares. System will understand and help to compare only comparable data. Thus eg. water pump with power 1,5 kW AND 20 kPa headPressure will be comparable to other pumps with power 1,5 kW AND 20 kPa headPressure and maybe other specifications for filtering added. Data forwarded for compare will be stored in individual tabs with its own change-history (also working undo, redo, save/load data functions).

Comparison can compare same data type change over time, in numerical value. Together two or more data sources can be compared. For comparison can be specified graphical explanation from the list of graphs. If more data sources (data types) will be compared together and over period of time also, comparison in 3D model can be used , with third dimension specified as time dimension.

=====

G_UC003 Compare

No.	Actor	Activity	Condition
-----	-------	----------	-----------

1	User	User requires to compare comparable data, whether from functions <i>Approval Process</i> , <i>Search Data</i> , or other, where is <i>Compare</i> function specified as <<extended>> the main function. marks specified data, by right-click selects an option <i>compare with...</i> , and specify data source where to find comparable data	Data must be comparable : the same kind
2	System	Accepts compare data request, open comparing window, where started comparing will open new tab. System then offer another sources which could be possible to be compared with selected data. Same data can have an option to be compared with itself in the time chronology change	Data must be comparable : the same kind
2.1	System	System is able to offer specific graphic comparing tables from the list of graphic tables.	
2.2	User	User specifies which data sources will be compared, and specify form of comparing (rows, columns or 2D / 3D graphs from library) There will be possibility to specify specific data in the X,Y(and Z if possible) axes	
3	System	According User's inputs shows compared data, offer an option to save/tag/forward result data or comparing template and to export results data.	Function is required by the user

Case study No.1 of G_UC003 Compare function :

Case study scenario : Let's say that investor who already obtained BIM design with BoQ list and concept says that first cost evaluation made based on this BoQ shows very high price. Investor needs to save 20 % of the budget and he does not know in which part of project should be project "quality" decreased with less negative effect on the project value. Shall be specified cheaper building envelope ? Shall be installed cheaper chillers with lover efficiency? Shall be decreased amount of chilling units inside interior ? All is possible but with different effects so he can set these as questions for changing design according these "variables" and compare results.

Compared results reasonable for Investors could be (but may not be) : Indoor quality , Energy consumption, and Market Value of building on the market .

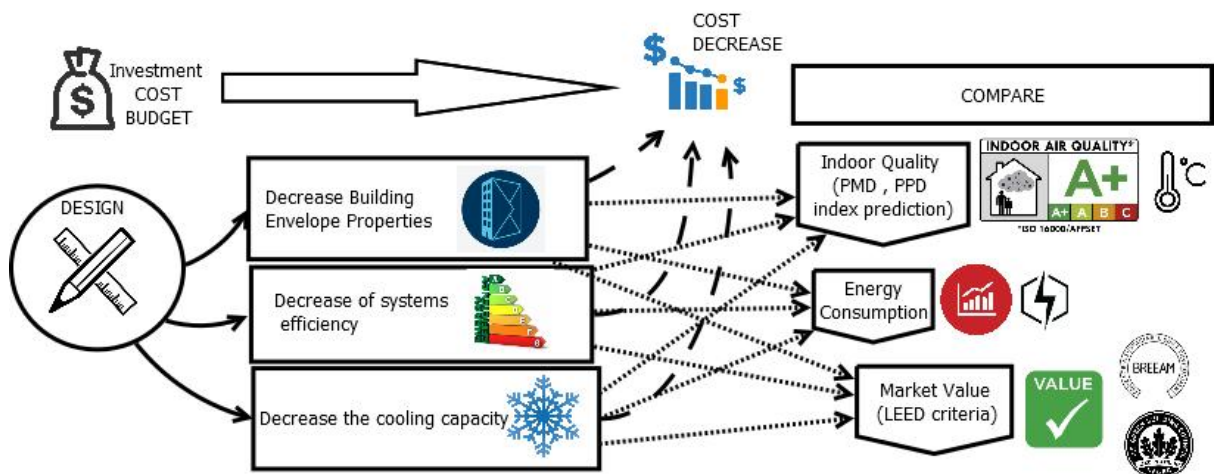

Figure I.01: Example of compare function for Investor demand, source : Diaportable graph design

Case study No.2 of G_UC003 Compare function :

Case study scenario : Let's say, designer is hesitating which terminal units for heating system to use. After using function search, where he found 6 manufacturers of heating terminal units which fits his basic requirements (also possible by designer of use *Set Criteria* for further design specification informations) . Now he wants to compare specific pressure drops at water side loops in specific operating condition and select the best possible alternative. With selected these 6 possible product under specific operation condition, he select criteria for compare : pressure drop (kPa) on the water side.

Tag Information function G_UC004

Use case name : Tag Information
 Use case Identification : G_UC004
 Actor : General Actor
 Restrictions : Actor is not logged in system
 =====

Tag data is easy to use small application which reason is to fast inform users about data informational value by giving the information a specific subjective *adverb* and help the information to be spreaded within small workgroup or wide public community of users (depends of the tag visibility settings). As Tagged information will be seen and possibly accepted and forwarded (or "liked" as You know) from subjective information can become kind of "objective" information.

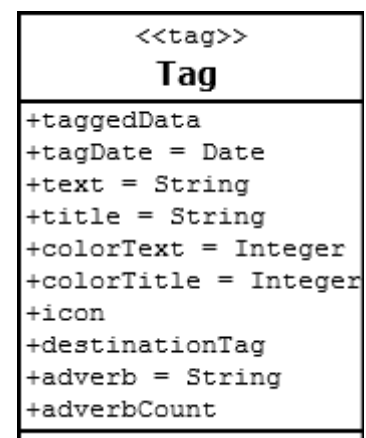

Figure C.8 - Class diagram of Tag object, source : Diaportable graph design

More “likes” or “dislikes” (or any of attribute specified by User), bigger the informational added-value the information will have.

Occurrence: This is kind of fast-forwarding the experience of users with the matter of their focus. Tags will be crowded within databases, and permanently joined with core information glued to, can be searched also in the search function, but often will be autonomously shown on side panel of the main profile page in the IS, where the place for tags will be placed. Tags will be shown to user with similar focus and duty as tag content is. Also the tags will show up if data processed with user are very similar with tagged data. This can be productive and even crucial to find critical information and absorb kind of “community experience exchange”.

Tag attributes: Tag adverb can have know forms for simply tag them in the chain of readers who will find and read the tag. Adverbs can look like known “like” or “dislike” but tag creator can create adverbs according his needs or select some most common used, i.e. *true*, *incorrect*, *not solved*, *solved*, *very good*, *interesting*, *not tested*, *invalid* etc., he can do, similar as in *vote* function, use specific “only one” selectable adverb which could be chosen by reader. “Tag ratio” is count the number of tag adverb clicking by other users, and gives to tag specific informational value. There will be possibility to set the counter-argument if necessary and circumstances require that which can earn also “tag ratios” .

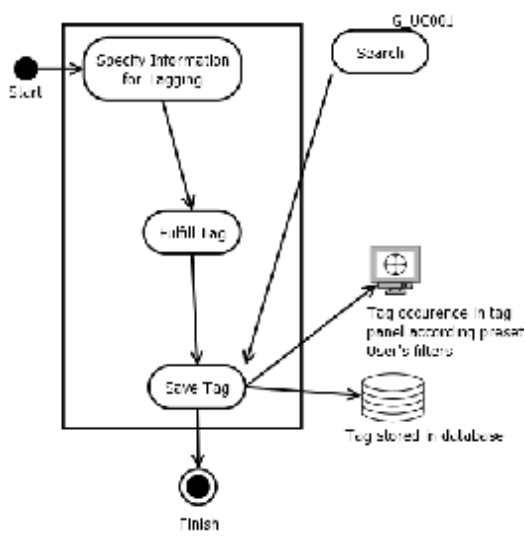

Figure U.01d: Use case diagram for Tag function, source : Diaportable graph design

Destinations: Tag may but may not be destined to be shown up in some destination. Tag destination addresses examples : working group, own IS profile, public thematic group on IS, social networks sharing, etc..

Information structure: Tag will contain tagged information, where full informational source can be shown up for reader if required, it may contain comment about it, and tag adverb (adverbs). Comment is due to basic informational modesty of tag hidden in it but able to roll of the full readable comment. Comment shall be able to set traditional text properties such as bold, italics, underline.

Tag is based on arguments: Tag information and its subjective emotional coloring can be defended with argument. Tag can be “accepted” by new reader as written above, or countered by counter argument which you can clarify information in tag, or information which is tagged. Basically You can Tag the tag or counter its information with adding more correct or valid arguments (informations). This is the step

for further archivation and later clarification (by “voting” of the adverbs in tag with other users), and find out the final true (if necessary and important).

Tags can be searched by the tagged information kind, time, according specific user. Users as Tab creators, can be also evaluated by some measurable metrics set preferably according common used types of tag adverb types (i.e. *true*, *correct*, *incorrect*) for their experience and information performance, thus credibility.

Case study No.1 of G_UC004 Tag Function

Case study scenario : Let’s say You are heating systems designer who is now looking in database for some schemes of BAT (Best Available Technologies) on the market. From this reason, autonomous tag occurrence interface will show the tag from Figure WF.02 because it see Your data investigation in the IS is similar to tagged data. You will read it, and assume that informations You read is not according to Your experience. You are sure The message is incorrect because in Your branch is clear that lowering prices is due the fact discounted systems are not BAT ever more. Then You find out the same opinion as You have has other 1231 persons (probably persons interested in heating systems) so You simply are become more confident in Your judgement. In opposite scenario, If You would see specific fact about the information which assume this information is not incorrect but correct, You can tag it and set the Counterargument. The right example of Tag is this case where is first counter-argument made by You as confident in Your true.

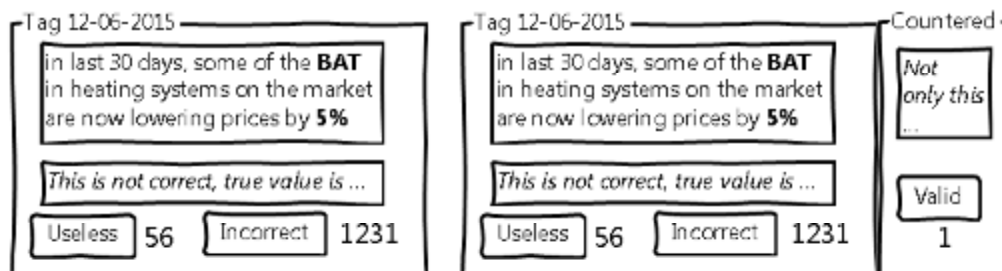

Figure WF.02: Wireframe example of Tag. Tagged information is *some heating systems BAT prices lower by 5% in the last month*. We do not know more, *which* of BAT systems and on which market it is specified. Tagger did not tag information about place and type of BAT, which will be necessary to investigate by source information. Source Wireframesketcher Studio design

=====

G_UC004 CREATING TAG

No.	Actor	Activity	Condition
1.1	User	User defines specified information (text, table, specific number, result, communication message, etc.) for tagging.	
1.2	User	User will select specific mark (adverb) from the list of existing adverbs, or can create his own new addverb.	If new Adverb will be created, it shall not exist

		tag can contain whether basic adverb : “like”, also can contain text in color with graphic icon,	in the list of existing.
1.3	System	System offers saving the new adverb	
1.4	User	User will fill the comment text for the tag, if necessary	
1.5	User	User will specify adverbs and comment text properties (color, etc.)	
1.6	User	User will define places, where Tag shall be visible if he requires to.	
2	System	System will accept Tag request and tag it according inputs of User and place it on specified tag destination address	Information must be able to be tagged
3.1	User	User can compare this Tag with other Tags by function <i>compare</i> .	Function is required by the user
3.2	System	System will offer possibility to check whether exist other similar Tags. System will search Tags with similar commented data, i.e. if specific temperature will be tagged, so IS will look for Tags commenting temperature as well	Tag must be comparable, thus specific similar Tags in system already exists

G_UC004 READING TAG

No.	Actor	Activity	Condition
1	System	Will show up Tag within automatic occurrence in the main user page panel according preset filters, or according actual similar data processing by User or specific tag search by user’s search by G_UC001	User must be interesting in Tag evaluation
2.1	User	User can read basic tagged data, read comment. Function can end.	
2.2	User	User can mark specific adverb by clicking it. Function can end.	
3	System	System offers availability to counterargument the Tag.	

4	User	User will fill up the new “Tag of tag” with counter argument. (basically new Tag glued to old one)	
5	System	Tag will be saved with original tag, with counting its validity by other users	

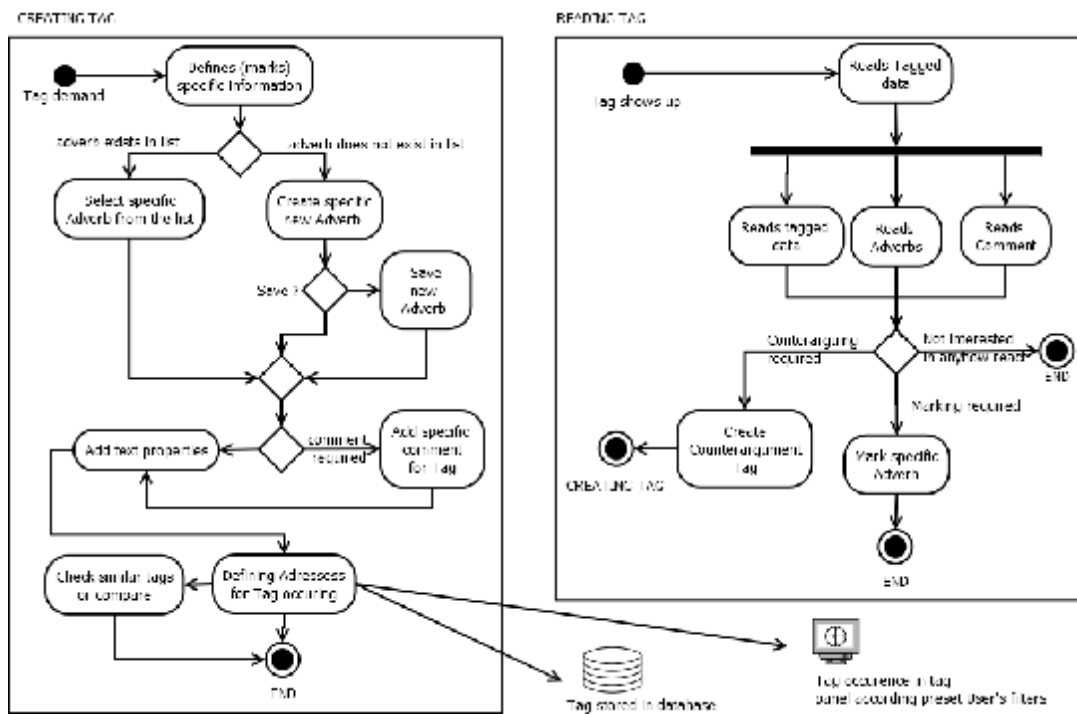

Figure A.10: Activity diagrams of creating and reading the Tags. Source: Diaportable design

Vote - Elections function G_UC005

Use case name : Vote (Elections function)
 Use case Identification : G_UC005
 Actor : General Actor
 Restrictions : Actor is not logged in system

Vote function will give the user possibility to lead decisions within policy of “democracy”. Many occasions, but not all, can be solved by simply voting of all participants. Vote can be and will be used in most cases, where main decision maker does not insist of its own opinion and gives chance to others to *vote* or can be a useful tool to “let the public decide” in specific circumstances which could occur during building process when sensitive questions and issues will appear. *Vote* function can be also used as questionnaire for evaluating specific issues or questions.

Vote function will show up the user (creator) form where informations such *question*, possible elective *answers*, *date* of voting process ends will be filled in.

Elections shall have attributes for select within compulsory voting for all (all must vote, missing electors could be urged in repeating frequency or after specified time deducted from the whole number of voters), optional (result will be computed only from the total number of voters). Voting answers shall have possibility to be answered by *multiple choice* (only one from offered answers can be selected) and *checkboxes* (more than one answer can be selected). Vote form can be send for voting process to specific working group users, partners, public space in IS (unknown IS users could participate if interested), or even forward outside the IS to different networks (i.e. LinkedIN etc.) and via e-mail.

Function will be able to call by right mouse click menu or from different functions, where *vote* function is extended within it.

=====

G_UC005 Vote (Elections function

No.	Actor	Activity	Condition
1.1	User	Call up the Vote function from different functions or from right-click mouse menu	
1.2	System	System offers the voting form to fill	<i>Vote</i> function must be available at the time of request
1.3	System	System allows fill specific inputs (questions, answers, dates) and to use specific <i>Tags</i> , <i>Search results</i> or <i>comparing results</i> within the voting question.	
2.1	User	User defines question (together with using offered possibilities from point 1.3 if required), answers, dates of voting finish, dates of voting reminders for participants, specifies also attribute of vote process (compulsory, optional) and types of answers (multiple answer, checkboxes)	
2.2	User	Specify destination places or addresses from the address list for send the voting form	
3.1	System	System sends voting form to specified destination places and users	Form must be completely fulfilled
3.2	System	System receives and stores the answers, remind voting process according creator's settings.	

Embedded Applications and Agent solver functions G_UC006

Use case name : Embedded Applications and Agent solver functions
Use case Identification : G_UC006
Actor : General Actor
Restrictions : Actor is not logged in system,
User is authorised to use specific application

Applications which will be embedded, are actually not specified more. Basic requirement for this functionality availability is good compatibility with other software applications which can be “seeded” on the Cloud system as functionality modules. For these small applications development could be used for example Wolfram Mathematica which is worldwide well known application for data processing modules development. Function provides the agent solvers initiation and selection within evaluating their results. Agent solvers are considered as specific Actors (Agent solver (Ag)) in the IS.

Manage Data G_UC007

Use case name : Manage Data
Use case Identification : G_UC007
Actor : General Actor
Restrictions : Actor is not logged in system

=====

Manage Data, especially *Bill of Quantities* (BoQ) preparation has high importance over more project life cycle phases. This work process (BoQ preparation) is very important and time consuming and has high threat to make some numerical mistakes when it is created manually with dangerous financial impact of BoQ creator as well as other participants of building process processing the BoQ data. Manual preparations in BoQ is actual situation in most of designing companies.

In the Figure SD.1 You can see State change of form of Bill of Quantities data during the project phases change. BoQ is created in design phase (quality, quantity and data structure will be created and continuously modified by Designer) and then further forwarded and managed by Investor for Tender announcement and then converted by General contractor and Subcontractors (price proposals for Tenders, where prices will be changing) and then forwarded to Supplier for next price proposals of specific building parts. It is a main data source document for tendering the subcontractors and suppliers.

BoQ preparation consists from lot of data conversion from BIM design into tablelised data structured according the building professions - Structural design, Waste piping, Water piping, Cooling system, Air ventilation system, Heating system, Sprinkler system, Electric wiring system etc., each done by Designer of specific profession and created with sub-structures form in BoQ for better orientation in tables.

BoQ management will provide functions to modify BoQ data, able to *move*, *modify*, *create* and recreate *structure* and *edit qualitative* and *quantitative data*. It also provides basic editing functions as *undo*, *redo steps*, *saving* possible templates of data structures or data values (BoQ documents), make new or modify informations or delete them and similar supporting functions.

This BoQ preparation part can be considered as raw data preparation, which is often born from BIM design (but may be created outside BIM within the D_UC001 function in simple format).

Figure S.2 with state diagram in Figure SD.1 describes the data created of *Manage Data* in the form of BoQ preparation in various states and situation throughout building process development.

First BoQ data are created during conceptual phase and is more or less modified continuously during the design process. There are many pros and cons for using BoQ exact from BIM 3D design and function *Manage Data* can help with solving the cons which are not often avoided during the process. BoQ is created within BIM, or other design platform or can be created by simplified method in function *Conceptual Design D_UC001* as mentioned above. In the case of importing complete BIM design with the function *G_UC008 Data Import/Export*, there shall be possibility to create tabelized BoQ data. Data in the IS can be then edited in the basic manner of the table data editing - items grouping and marking, changing technical information details in equipment items descriptions, changing their amounts or occurrence.

Created data in finished BoQ (also determined and verified with function D_UC002 *Validate Design Criteria*) are transferred between different roles in IS from Designer, throughout Controller and Contractor finally for Subcontractors and Suppliers. Each Actor role requires from BoQ different informations and manipulates with them by different reasons differently.

This function can be used by various Actors in the collaboration chain with specific restrictions or other functionalities rights.

Management will consist also from functions for revisions, updates and modifications of the same BoQ during the development of project (after BoQ Validation by Designer), hand in hand with the possible project design changes. It shall be always possible to determine, *which* data have been in the BoQ modified, *how*, *when*, *by whom* and *why* in the structuralized history of BoQ change. This functionality will be assured by continuously saving the Logs of activities of all users using the IS.

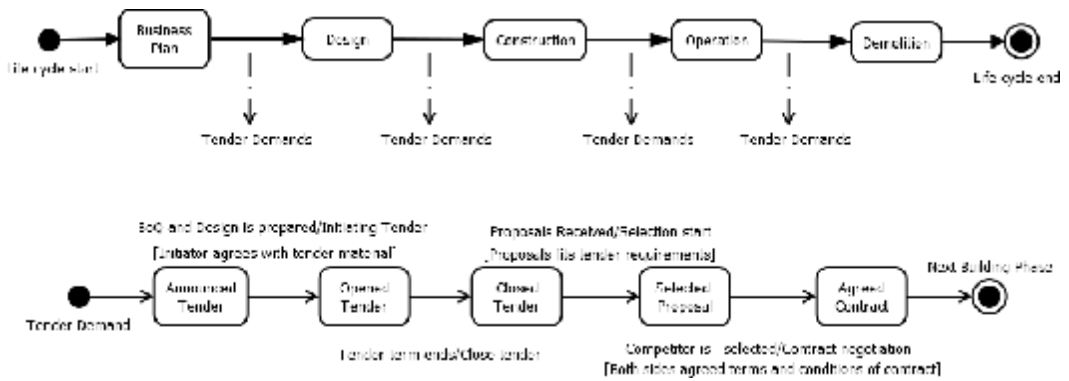

Figure S.2 : State diagram of the building project phases with description the occasion of tendering, and state diagram of main Tender states for valid for all Actors involved in the process : investor (or owner), designer, contractor, subcontractors and suppliers. source : Diaportable graph design

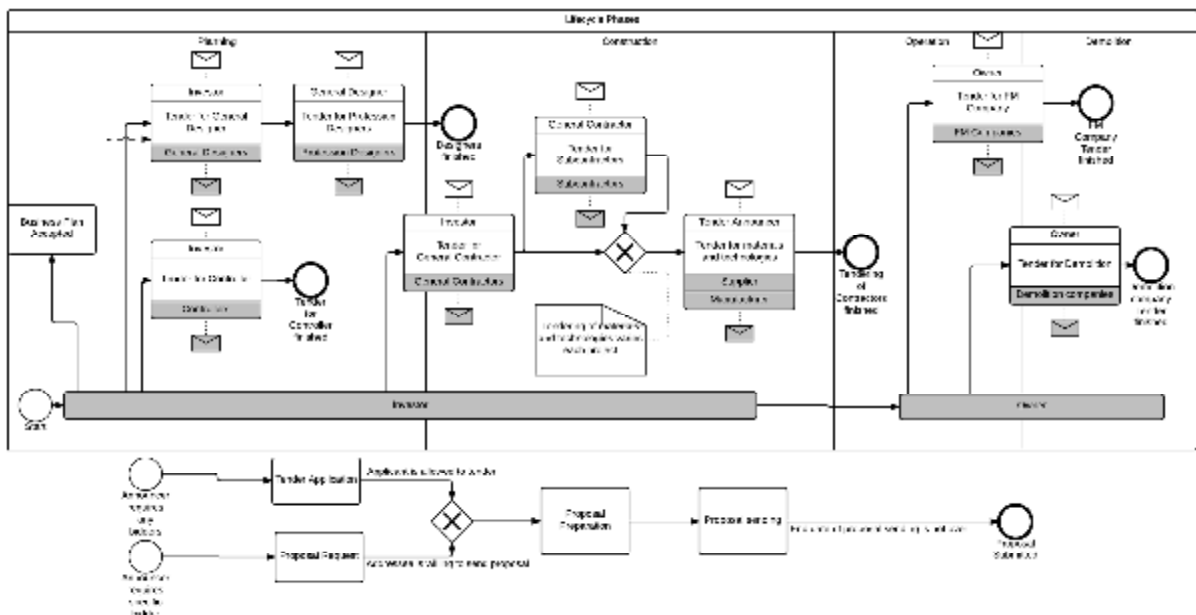

Figure S.2b : BPMN Choreography diagram describing the building project phases with description the occasion of tendering, needed by contractor, subcontractors and investor/owner. It is important to mention that border between planning and construction phase is not exactly clear and tenders for construction may take place during planning phase as well, in specific circumstances vice-versa state also is possible. In the lower diagram is simplified process of application to any mentioned tender by applicant. Source : Lucidchart design

Owner after Business plan set is announcing selection (Tender) of first partner - General Designer - usually an Architect or group of architects. Designer can apply and compete in the selection process and one Designer in the selection will be specified. After this step, usually General Designer announces selection and select profession designers which will be created basic project planning team with him. In this phase are

created concepts of each profession hand in hand with main architectural concept. Each profession concept brings with it its own Bill of Quantities. This will be building brick of *cost estimation* (of investment costs) for all parts of the building and planning process (conceptual, building design, construction design). Designer will create the information structure (project profession design) on which behalf is BoQ thus costs created and depends on it. In Contractor selection phase is important to transfer these BoQ from Designer to General Contractor, then to Contractor and Supplier with empty prices for fulfilling the prices by construction professions by their required prices and creating their price proposals for competitive selection process in project. BoQ may be in circumstances of Public finances tender anonymized also from the side of “trademark” specification, which is not acceptable but only technical properties shall be stated. In commercial tenderings BoQ may include specific product trademarks and depends of the criteria of decision-maker (investor) whether can tender applicant change his proposal with some technical or quality discrepancies comparing the BoQ thus with exact Designer s design (not possible in public tenders) or not.

=====

G_UC007 Manage Data

No.	Actor	Activity	Condition
1	User	Login and select function	
2	System	System offers data import via <i>BoQ Import/Export G_UC008</i> function or use data forwarded from <i>D_UC001 Conceptual Design</i>	data for G_UC008 must be prepared for import or data from D_UC001 must be prepared
3	User	Select specific data for use and edit	
4.1	System	Offers to User edit possibilities : Moveup, Movedown, change structure, quantity and description, possibility to anonymize whole BoQ or specific elements (products), system also offer to use other General actor functionalities (G_UC000, G_UC002, G_UC003, G_UC005) for cooperation with collaborators	
4.2	User	Edits data. When done, saves as specific BoQ	
4.3	User	User may specify data as Verified Valid Design by <i>Validate Design Criteria D_UC003</i> for further forwarding within building process	Data are ready to verify
5	System	Saves BoQ. Offers next steps : send to some of other collaborating partners (different IS users)	

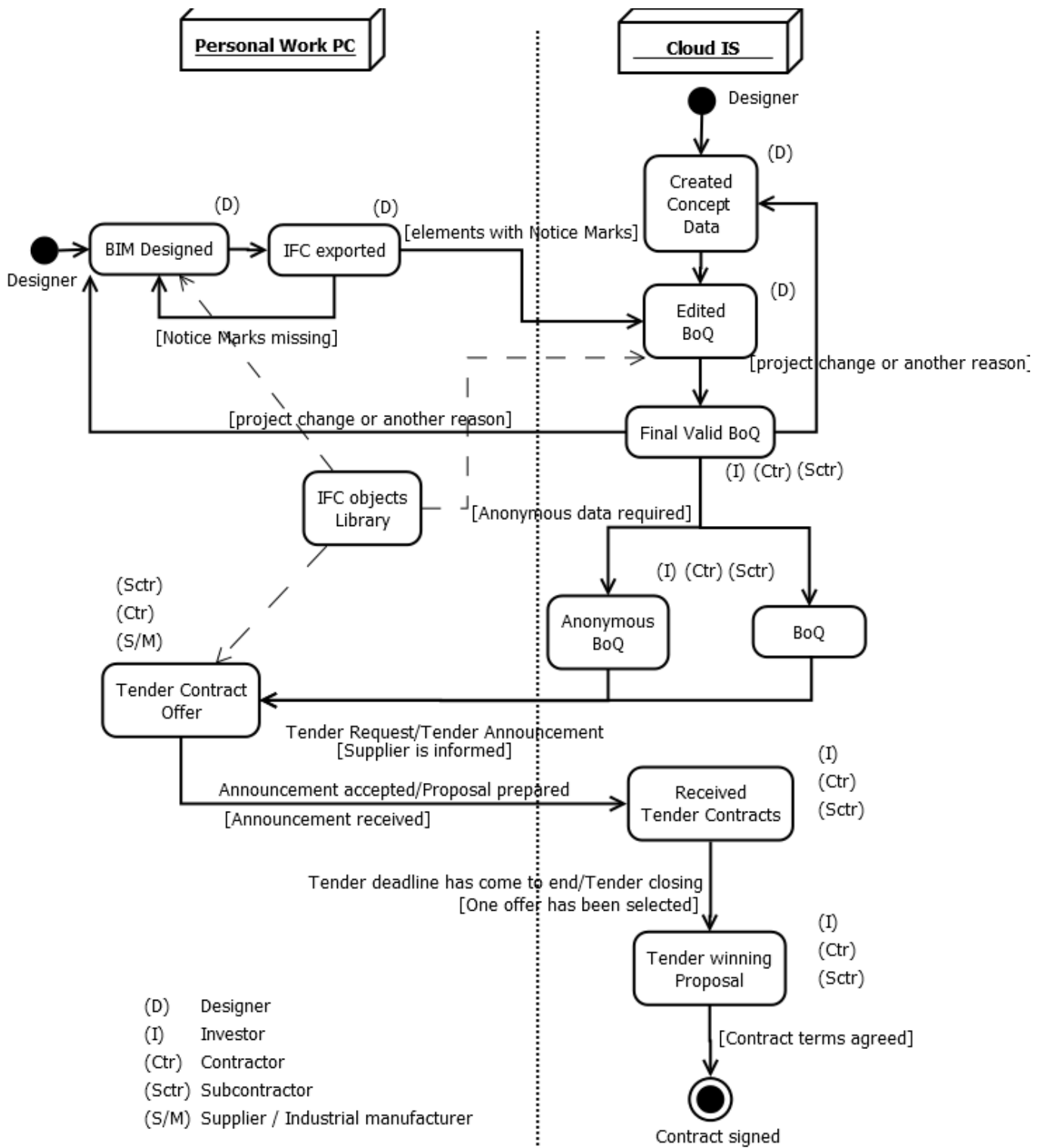

Figure SD.1: State diagram of data transfer from the Bill of Quantities to final tendered budget with commercial price contracted for project, source : Diaportable graph design

Data Import/Export function G_UC008

Use case name : Data Import/Export
Use case Identification : G_UC008
Actor : General Actor
Restrictions : Actor is not logged in system

=====

This simple function is ready to import or export IFC Data and BoQ tables as well as complete BIM designs or specific separate product throughout IFC file format. Thus it is function included within the G_UC007 Manage Data, SM_UC002 Product Data Input, SM_UC001 Product Data Management functions.

Monitor Processes function G_UC009

Use case name : Monitor Processes
Use case Identification : G_UC009
Actor : General Actor
Restrictions : Actor is not logged in system

=====

Monitor the processes can be helpful during many different processes, to help the overall management of project development progress, partners activities progress, or help for learning and preparing better designing concepts. The main description of the function release on its proper setting according the philosophy of S.M.A.R.T. objectives (Drucker, 1954).

The monitoring of specific process must be understandable by machine, thus needs to be specified **what** will be monitored (S. as *specific*) , **how** (M. as *measurable*) the monitoring results will achieve the needed requirement (A. as *Agreed/Achievable/Attainable* and R. as *Realistic/Responsible/Receivable*), how often, how frequently needs to be monitoring active, respectively till when shall be the final result achieved (T. as *Time*).

This function can be implemented within Designer's effort to monitor actual information sources (i.e. running installed system operational data) with conditional notifications of the results.

Also this function may be used for joining it with contract terms and conditions where both sides of contract agree specific condition which must be fulfilled for successful contract finish with possible alternatives what to do if the conditions were not fulfilled. Monitor the process would thus be objective decision maker or whistleblower showing the fulfillment success or failure during specific contracted partners cooperation.

For monitoring especially external data sources for evaluating purposes will be necessary to prepare for this function *API* modules which will be able to continuously monitor and download monitored data to the IS.

(S) Specification of monitored data - sets the data source for monitoring, where the monitoring should look for data

(M) Measured form and content - sets content - specific data types if the source contains more data types in the matter of physical quantity, types of units, etc. and sets the form - i.e. amount of decimal places, rounding values, peak values, cumulative values per specific period , etc.

(A) Setting of the states of Achievability and Non-achievability - sets the conditions and states when the measurements would be considered as (for example) *successful*, *approved*, etc. here will be possibility to set the conditions for notifications (whistleblowers). Notification addressee will be specified within (R) . Conditions may be numerical or verbal, the verbal condition fulfil the (R) subject with submitting also possible necessary data or documents.

(R) Subject or Source responsible for monitored data - specifies the subject who is responsible for the monitored data (data creator) - i.e. installation company is responsible for is progress during construction works, designer is responsible to prepare design (data M: design submitted) on time according dead-line , here is possibility to set the addressee of the possible notifications

(T) Set Time properties - setting the frequency, total amount of repeating, deadline of either the monitor process or notification.

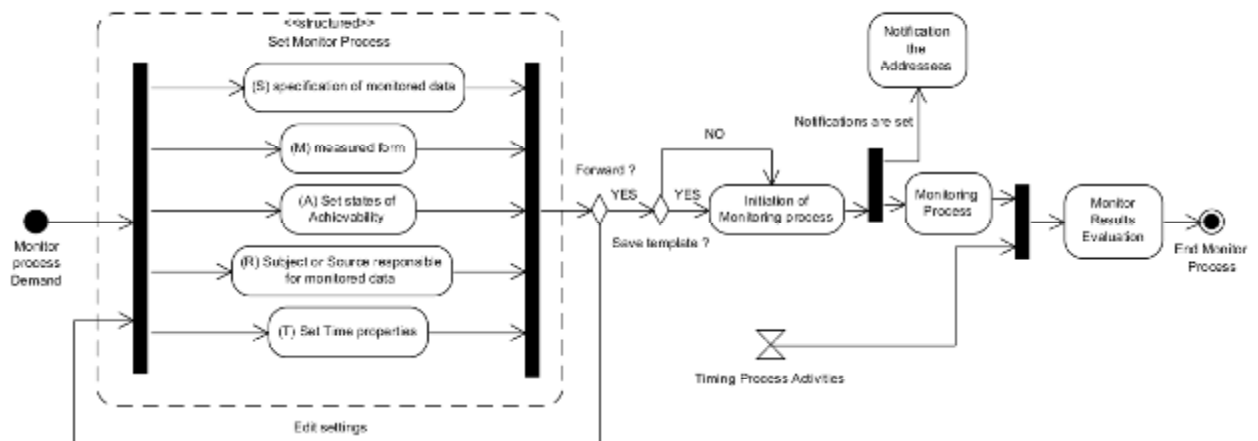

Figure A.12: Activity diagram of initiation and setting the Monitor function, source: Visual Paradigm design

G_UC009 Monitor Process

No.	Actor	Activity	Condition
1	User	Login (self define as type of Actor) and initiate the function.	
2.1	System	System will offer setting window with S.M.A.R.T. attributes of function	
2.2	User	User will specify the source of specified data with (S) specification of monitored data	data source must exist within or

		attribute	outside the IS
2.3	User	User will set the measurement form and content by (M)	there are more data forms than one or more data possible content than one
2.4	User	User will by (A) set possible states of the monitor results with setting the conditions for achieving them.	States must be of minimal amount of 1. States must have set condition for their achieve
2.5	User	User will select specified responsible sources or subjects for the data results by (R) . Also specifies set the addressee for possible notification.	Source or subject must exist in IS database. Addressee must exist in IS addressee directory.
2.6	User	User will set time properties with (T)	
3.1	System	System will offer going back to revise setting	Some required set data are not set, or User wants to edit settings.
3.2	System	System will offer the monitor initiation, system will offer to save template of monitor process.	All required data are set
4	System	System process the monitoring process and possible notifications during the set process time.	
5	System	System will show results. System will offer save the results or data. End of Process	Process end time finishes.

Tender function G_UC010

Use case name : Tender
Use case Identification : G_UC010
Actor : General Actor
Restrictions : Actor is not logged in system

=====

Last but not least between most important functions of General (thus all) actor is the tender function. It gives to actor chance to participate within announced tenders

filtered according his demands and fulfill his own business plan by realising by his own business activity (which has each participant of building process different).

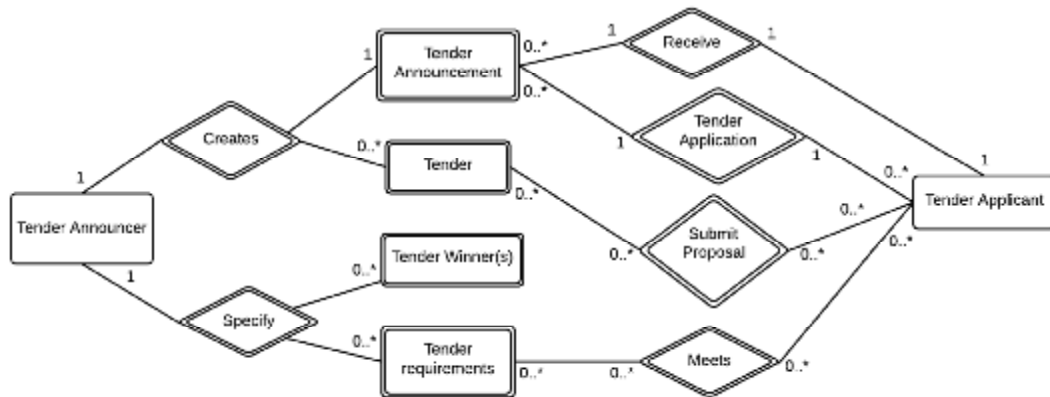

Figure ER.11: Entity relationships diagram of the Tender process, explaining the participants and their relations, source : Lucidchart design

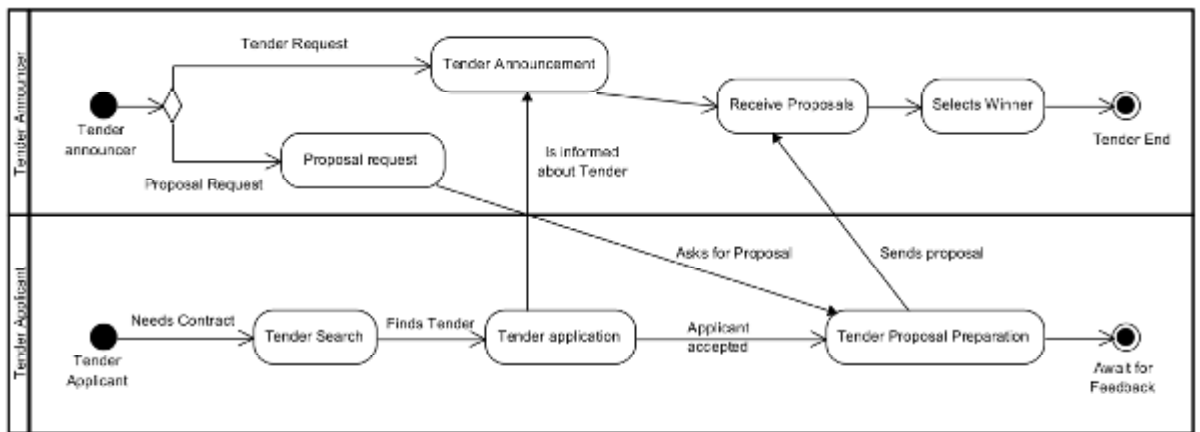

Figure A.13: Activity diagram of basic sub-functions in Tender G_UC010 function, source: Visual Paradigm

As You can see on the Figure ER.11, *Tender Announcer* is requiring partner for fulfil his needs and creates *Tender Announcement*, which will inform possible *Tender Applicants* which have found the announcement in search process by search filter set. Interested applicants apply for tender. After Their Validating via announcer the can give access to tender informations and post the proposal. They will have to fit many pre-tender or contract conditions which can reject them from the process if they will not be able to fit them. After the end date of tender reaches its edge, announcer will evaluate received and raised proposals according his priorities and requirements and select a winner. Winner may be of the amount zero or more than one. If there will be nobody selected in the tender, announcer may repeat the announcement with same or different requirements or he may to cancel it.

All G_UC010 Function subfunctions are visible on the figure A.13. They can be specified as Tender Search, Tender Announcement, Tender Application, Tender Proposal Preparation, Proposal Request and Winner Selection, together six important parts of tendering function.

Two more complex functions were specified: “external” part - looking for business possibilities and application for the tender (G_UC010-a) and “internal” part - preparing technical and price proposal for tender submittal (G_UC010-b). Tender announcement, selection winner are very simple and not need to get full description.

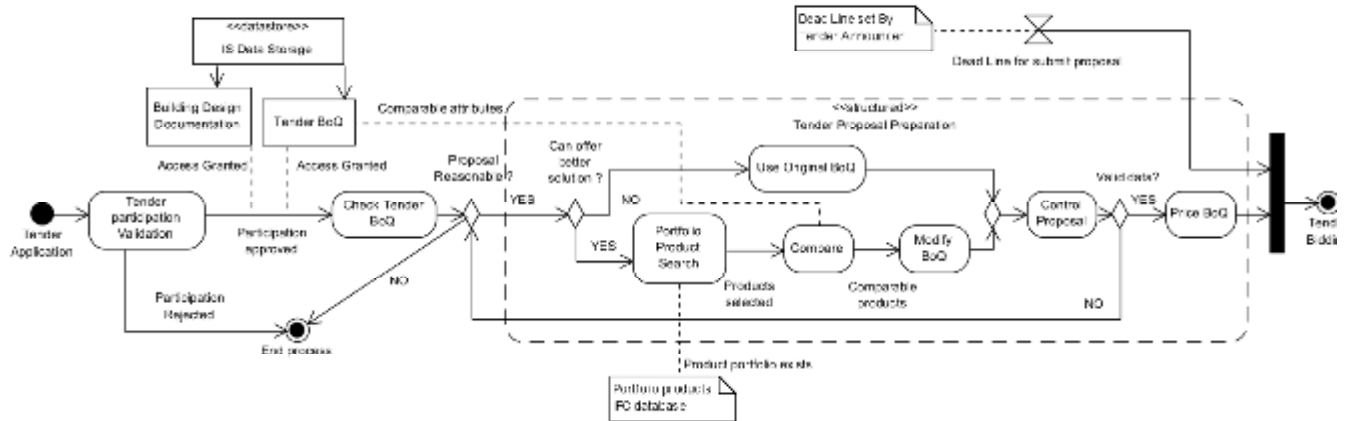

Figure A.8 : Activity Diagram of Tender Proposal Preparation process logic. It is important to mention that this activity can be repeated within tender several times between one Tender announcer and more Tender Competitors for obtaining the best competitive price for best competitive performance in the philosophy of moving closest to the economic theorem *perfect competition market* , source : Visual paradigm design

G_UC010 TENDER PROPOSAL PREPARATION G_UC010-a

No.	Actor	Activity	Condition
1.1	User	Login (self define as type of Actor) and finds tender <i>tender announcement</i> on the IS which fits his interest and business availability.	
1.2	User	Will apply for participation and competition in tender selection, sends an application.	
2	System	Will send documentation for preparing proposal	Tender participation of applicant is approved by <i>Tender Announcer</i>
3.1	User	User checks tender documentation and decide whether the tender participation is reasonable	
3.2	User	User will search products within his portfolio (which may suit Tender requirements or be different in some attributes together with giving some advance)	Differences between Tender BoQ and proposal BoQ shall be within tender conditions
3.3	User	User will modify BoQ hand in hand with proposal preparation.	Proposal is controlled and data

			are valid
3.4	User	User will add specific pricing to his proposal with payment terms and conditions and send proposal	Proposal send date is before closing date of tender.
3.5	System	System will remind shortly closing tender	reminder is set either by tender annoncer or by tender applicant
3.6		System will close tender	Tender end date did come to end.

G_UC010 TENDER APPLICATION G_UC010-b

No.	Actor	Activity	Condition
1	User	User obtain BoQ in “Tender” documentation during Tender announcement	User requests to apply for Tender
2	System	Will show the tables of BoQ with either specific or anonymised elements tables	
3.0	User	According tender limits, requirements and circumstances, user will ...	
3.1	User	Prepare prices in BoQ according his business policy for winning tender	
3.2	User	May Tender products and prices according BoQ by Tender announcement for the Suppliers, may change elements in BoQ for their substitutes on by searching in the product libraries with the coordinance of the step 3.1 (select suppliers). Use <i>G_UC011 Tender</i> function for price negotiations and transaction agreement.	elements-products in BoQ are either known or anonymous. must be in accordance with tender (investor’s) limits, requirements and circumstances,
4	System	Will offer to manage data within BoQ for price proposal preparing with G_UC007 function. There is possibility to edit, modify, add or delete specific rows, elements in BoQ respectively	
5.1	User	User finish modification, receives proposals from his Subcontractors and Suppliers and finish proposal	

5.2	User	User will send proposal in his Tender competition	all necessary data for Filling BoQ needs to be input
-----	------	---	--

Investor (I)

Main characteristics of investor is the *capital ownership, business plan establishment, decision-making right* and his motivation to *earn profit* and necessity of *investments evaluation*. The capital hold by the investor may consist of only his equity (private equity, private capital), or with may be combined with the foreign capital, where chances of obtaining foreign capital depends on type of business plan and his possible potential shown by specific *investment evaluation*.

His main characteristics in the scope of this work is that he can make decisions within his project development.

The inputs he is receiving for creating his business plan (programming it) from the surrounding is the feedback done by the public institutions throughout a spatial plan, informations about development policy of local geographic location, communications with BCA and by their official statements. The very important informations is receiving by his own investment evaluations by investor company staff or department.

Depending on the informations (data) inputs is the investor whether willing or not willing to start the business project, realizing the construction project.

When investor starts the building process, during each step of the project development, he holds decision making position about any aspects of other “players” coworking for finalizing the project and for successfully finish their aims and duties. He starts the main tenders for each phase and each matter of works on the first level mostly. That means he select main Designer (mostly Architecture atelier), main General Contractor, Controller. Sub-tenders to other designers professions or on site works is responsibility of selected in first level. He thus has opportunity to use the “*decisionmaker*” status in many cases in IS processes.

This main role of investor could be played as well with investor’s selected councilor or advise company. Functionalities of the Business plan Programming functions has high potential but are too wide to describe them in the scope of this work.

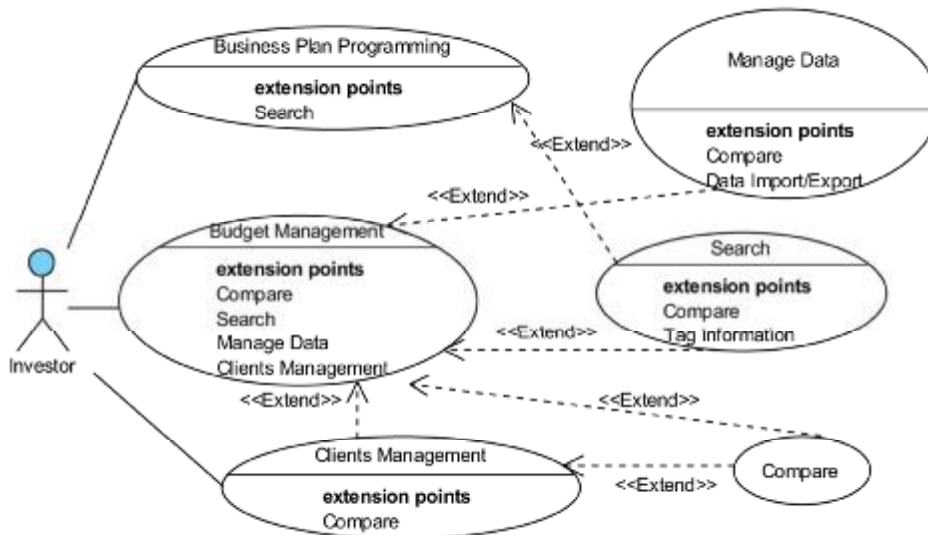

Figure U.2 : Use case diagram for Investor as an actor, source : Visual Paradigm design

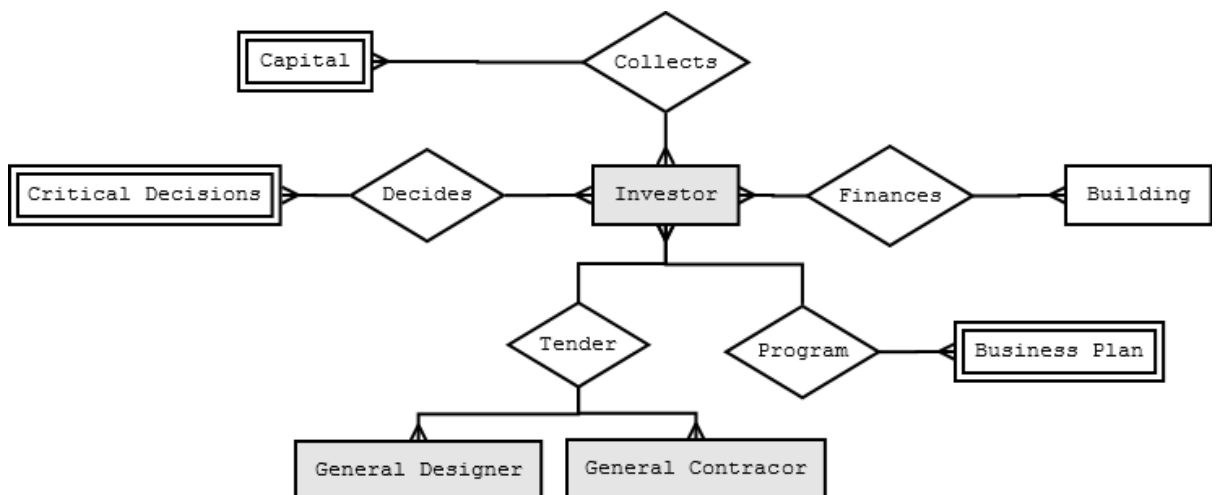

Figure ER.1 : Entity relationship diagram of Investor as an actor and his main relations with the processes and other participants, source : Diaportable graph design

Investor (I) functionalities

- Lookup for Investment possibilities
 - search - here is necessary to log database to different networks informations
- Budget management
- Investment evaluation
- Programing Business plan
 - Lookup for Foreign capital
 - Financial markets
 - foreign currency markets
 - shares emission to investment funds
 - stand-alone shares emission
 - bank loans

- External partner via Venture capital
- Comparison price/performance
- divide user (customer) according object part used

Designer (D)

Main designer's needs consists of graphical design side by side its logic design based on the technical regulations of specific profession and geographical location. Specified functions for Actor (D) in the IS involves the second mentioned. Designers functions are completely integrated with the functions of General Actor, and offers complete set of functions which could be named as "design circle". Where all of element function is used for specific reason during the designing and design modification process.

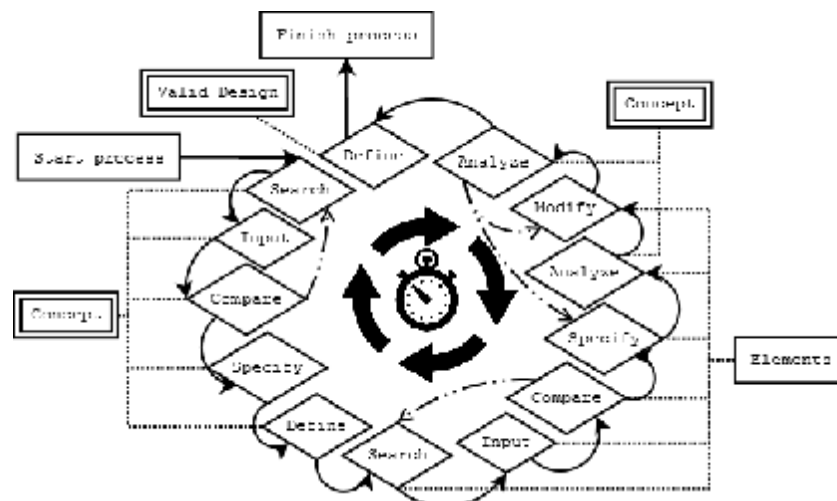

Figure ER.9: Description of the Design circle with most occurred places of going backwards in the process. Process needs to give valid credible results, doing credible results eats time. Time is money. Source: Diaportable design

Conceptual design is not a substitute for own-design at designer's working desktop and does not replace designing softwares. These are focused to activities when Designer already know, what to do and how design will have specific properties and view. But how will Designer find out these specifications ? Design functions in the IS will help in specific cases during decision process on beginning of the project planning phase.

Design process within the IS is basically the circle of repeating Designer's functions, D_UC000, D_UC001, D_UC002, D_UC003, (with General functions also of course) basically divided in more tables within one page. In the philosophy search-input data-search-specify-analyze and compare-search again-specify again- compare again-determine definite selection is continuously repeating the Design circle with use of each function as much as it needs as seen in Figures I.2 and A.7 below. From combination of all functions, designer can simply go back to the first steps of design and modify it according required results.

Designer (D) functions

- Search Libraries (concept libraries, BAT) (included already in General Actor's role as G_UC001)
 - search and product search
 - search
 - technical data
 - availability
 - modifications
- Conceptual design
 - Drawing conceptual schematics
 - lines, arrows graphics etc. (graphics marks should be connected to specific *element* objects, brand products on market respectively)
- Specify (Set) design criteria
 - Designer sets criteria of its design for further project processes
- Concept analysis (System Design's impact evaluation)

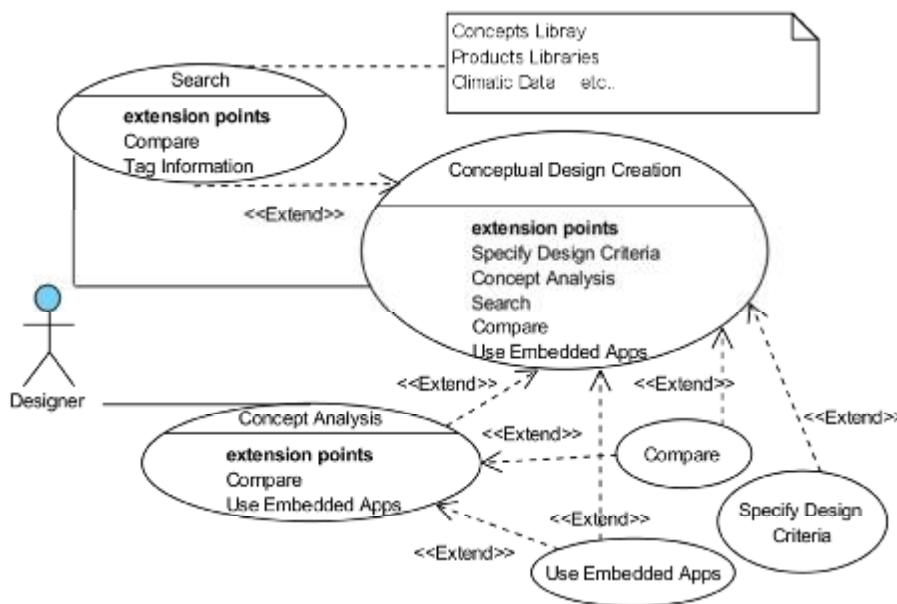

Figure U.3 : Use case diagram for Designer as an actor, source : Visual Paradigm design

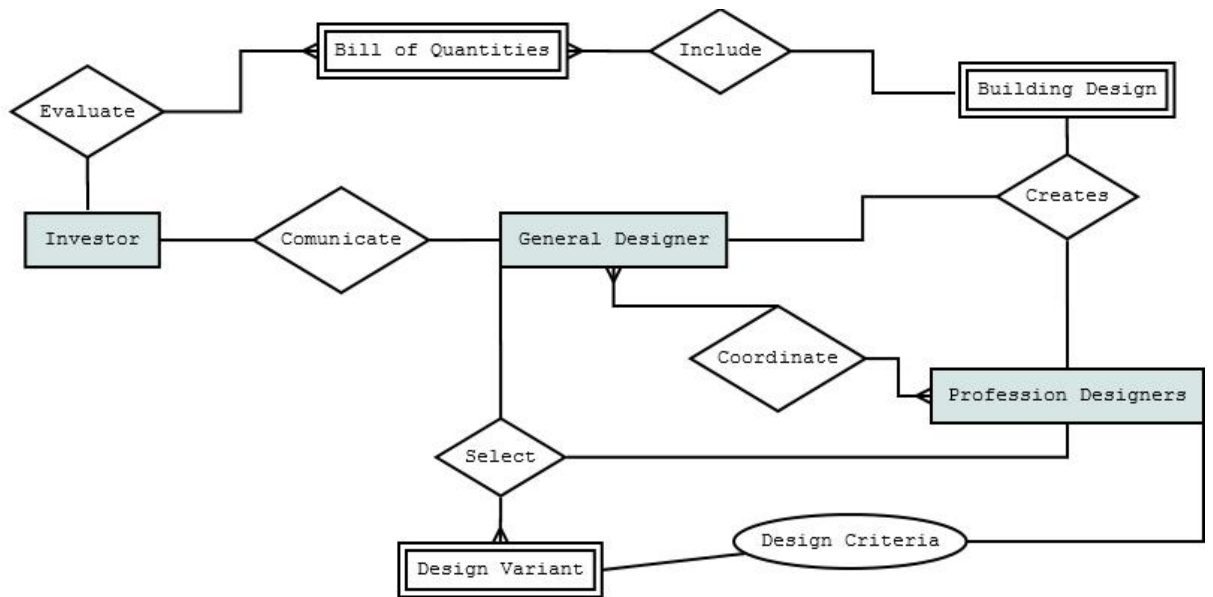

Figure ER.2 : Entity Relationship diagram of Designer as an actor divided into General and Profession designers in communication with Investor, source : Diaportable graph design

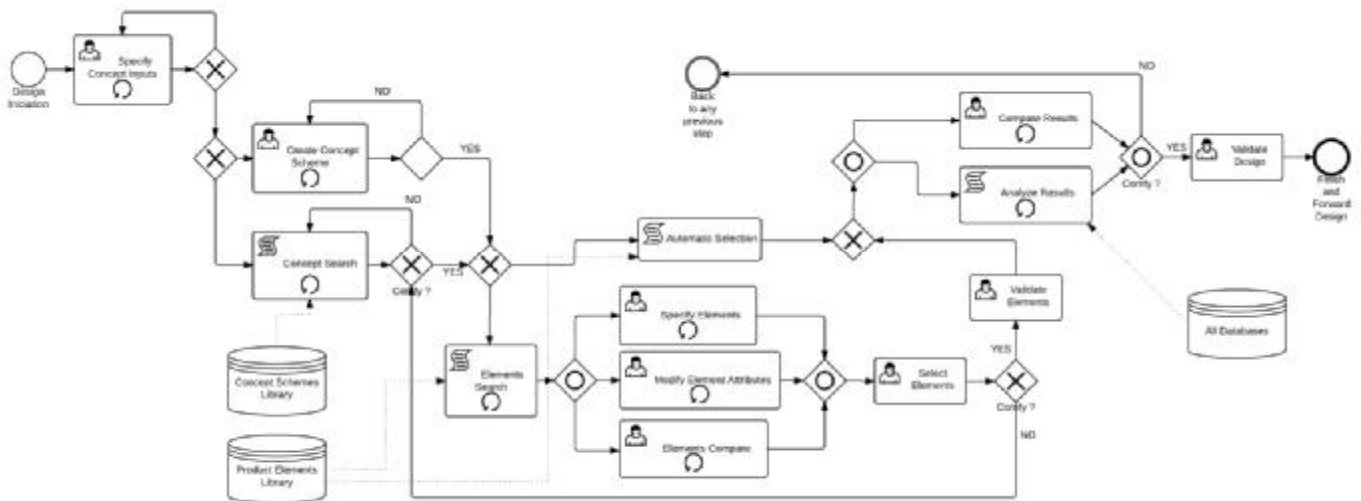

Figure A.7 : Activity diagram of Designer's most important activities within the IS, with subprocess of concept elements specification, source : LucidChart designer

Specific Activities built from Designer's and General Actor's functions can be divided into these classes and subclasses by the means of result required and design process step:

- System Scheme specification
 - Specify Concept Inputs
 - Concept Search

- Concept Creation
- Concept comparison
- Elements specification
 - Elements Search
 - Elements specification
 - Elements Attributes modification
 - Elements comparison
 - Elements selection, control and validation
- System analysis
- System Comparison
- System BoQ data management
- System control and validation

Libraries Search function D_UC000

Use case name : Libraries Search
 Use case Identification : D_UC000 (extended function of General Actor G_UC001)
 Actor : Designer
 Restrictions : Actor is not logged in system
 Other functions cannot run in main screen (background only);
 Actor is not authorised for specific process application

=====

Libraries search is derived from search functionality from the General Actor's function G_UC001. It has similar interface look. Main reason of description of extended function *Libraries Search* for Designer is possibility (and necessity) to create modified search window (with D_UC001 function of *Conceptual Design* function) for specification design concepts (groups of co-working elements) templates and libraries for systems elements. Two functions together, D_UC000 with D_UC001 are basically giving to the designer ability to find concept and fulfill it with the real products with analysing its coworking and result values what is meant as *design process*. This is not matter of 3D designing (which BIM softwares offers) but true functionality validation process.

Concept template can be considered as implicit structure to which can designer give explicit input with exact numerical input values and clarify "empty" template for specific project by importing exact technical input values e.g. areas, type of operation, air volumes needed etc.

Specific libraries of : industrial products as elements of system templates
 System templates libraries : whe are specified according designer's profession.

Numerical input values : technical attributes of systems and elements

Both libraries, product libraries and system concepts templates libraries can be divided into main class groups :

- BAS products
- Electrical
- Architectural
 - internal
 - external
- MEP
 - mechanical
 - electrical
 - plumbing
- Structural

Also situation, when one product or template will be necessary to be found in more than one class will be frequent.

Numerical inputs can be determined within more classes of attributes (properties)_

Physical properties: i.e. *weight, dimensions, transport dimensions, etc.*

Mechanical properties: i.e. *external pressure, head pressure, max.pressure, suction, temperature, temperature difference, velocity, sound pressure, sound power, etc.*

Electrical properties: i.e. *power input, starting current, operation current, voltage, RLA, LRA, energy consumption, energy efficiency- COP, EER, seasonal : ESEER, SCOP, etc.*

Manufacture properties: i.e. *product SN, manufacture date, Low-Noise version, etc.*

Economic properties: i.e. *list price, market price, energy price, firesales price, etc.*

Attributes classes can be of more kind than these five examples and system shall have possibility to flexible modify their structures, names and content.

Attributes shall be searchable within function G_UC001 (General Actor's function) already mentioned in work in the main search window, *pre-selection* and *detailed selection* tables. Attributes shall be shown in search windows according the clever appearing list to faster and clarify possible unnecessary in attribute selections during search.

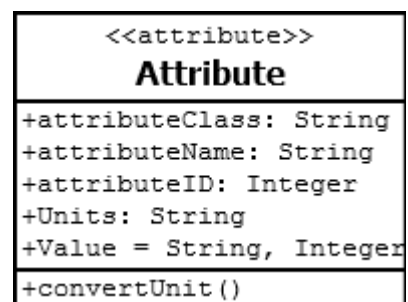

Figure C.9 : Example of an Attribute Class with its own attributes and operations.

Each attribute shall have its own possibility to show values in different units (Imperial, Metric) and ability to convert values from-to units (class operation: *convertUnit* as in Figure).

Each searchable element (product) has its own group of attributes which describes its properties, which are saved within the IFC file of element and shall have *static* or *dynamic* nubble.

=====

D_UC000 Libraries Search

No.	Actor	Activity	Condition
1	User	User Log into Search templates window or back-log from further steps of design process	
2	System	Offer available databases and search criteria , or offer to load saved search template	
3	User	Specify concept templates libraries or product libraries to search in, also with specified properties of concept or products required in search, or load saved search template	
4.1	System	Shows list of searched results, offers to save the search result criteria for future use	
4.2	User	User can specify selected results (concept or element) for further specification and modification. User can even extend search criteria according his needs. e.g. manufacturers from local country, specific manufacturer only etc.	
4.3	System	If specific elements has been selected, evaluating data specified attributes for analysis results (D_UC003) and price, description and count data for BoQ (G_UC007), specified compared values (G_UC003) are forwarded to specific functions	specified values needs to be set; elements are selected from search process
4.4	System	Is able to offer <i>Compare</i> function (G_UC003) for comparing specific searched results (concepts or specific elements) with modified first search or with newly created search; is able to offer <i>Concept Analysis</i> function (D_UC003)	comparable data exists and are specified
5.1	User	Select or save one or more concepts or products (elements) for further work with it	

5.2	User	Specify the selection with D_UC002 <i>Validate Design Criteria</i> and give the specification specific name	
6	System	Saves or forward data to another processes	

Conceptual Design function D_UC001

Use case name : Conceptual Design
 Use case Identification : D_UC001
 Actor : Designer
 Restrictions : Actor is not logged in system
 Other functions cannot run in main screen (background only);
 Actor is not authorised for specific process application
Service cannot be done without joining it with specific project

=====

Conceptual design is also based on the already mentioned rule to provide exactly required data in appropriate technical quality in very short time and this is its very strong advantage comparing self-pc-search of designers on their own effort. As mentioned in basic Designer's Actor's description, conceptual design is just part of all necessary functions which consists the whole design circle seen in Figure ER.9. Conceptual design glues all necessary other functions together within one page, where should have been all extended functions (according Figure U.2) included an available for the design process. Specified Relations of processes can be seen in Figure ER.10.

Conceptual design interface will be divided into more "tabs" according each Designer's profession needs. Professions division are similar than products and system concepts templates libraries division on description above.

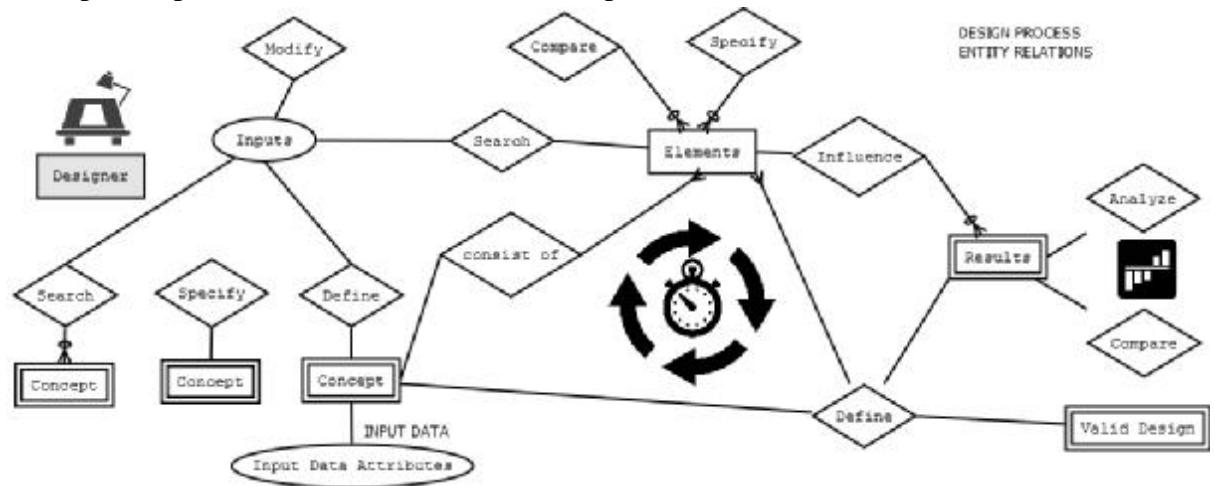

Figure ER.10: Entity Relations diagram with description of activities of designer as a whole, assume that entity “designer” is joined with all relations in the rhombus. Source: Diaportable design

=====

D_UC001 Conceptual Design

No.	Actor	Activity	Condition
1	User	Login and select function D_UC001	
2.1	System	System knows designer’s specific role - profession.(Architect, ventilation, structural, etc..) Opens interface for Conceptual Design according profession template	Actor has to have his profession specified in system
2.2	System	If User did not start with D_UC000 search function, System offer to start with it, or to create hand-made new concept without help of concept library	
3.0	User	User may create own concept scheme, or jumps To this step User may jump straight from search function D_UC000. He specify the needs of system which are technical data inputs.	
3.1	User	User specifies <i>general elements</i> in the already searched or created and then selected system concept template.	User has selection from D_UC000 or did create his own concept
3.2	User	User may modify elements attribute values as input for new search (jumps to D_UC000 and do new selection) OR modify attribute values with impact of elements properties without searching function	
3.3	System	System shows actual results from modified search results or modified selected properties. Also offers to analyze data with D_UC003 after specifying analysis results and offers to compare results after specified values for compare with G_UC003. This step can be repeated as much as necessary.	
3.4	User	User may forward data for compare or for analyze.	compared values must be specified or analysis results must

			be specified
3.5	User	User can use other Designer's functions, and General Actor's functions for his decisions and collaboration with his colleagues and contractor (General designer)	
3.5	System	Offers appropriate functionalities according User's needs, offers the possibility to jump to any of precedent steps in design process, joined together to one project case, saving activity logs of all collaborators and their activities	
3.6	User	Can repeat the search-specify-analyse loop as much as necessary over project design and its revisions and changes, and may specify the design criteria with D_UC002	
4.1	User	Will set on specific design parts the state as "Finished"	
4.2	System	System store all finalised data structure with status "Finished"	

Validate Design Criteria function D_UC002

Use case name : Validate Design Criteria
 Use case Identification : D_UC002
 Actor : Designer
 Restrictions : Actor is not logged in system
 Other functions cannot run in main screen (background only);
 Actor is not authorised for specific process application

=====

This is simple function determining searched, specified and determined concept and then concept elements and mark it as *Final Valid Design*. Of course there will be possibility to name each finished valid design with specific name or variant within one building project and there will be also possibility to compare defined data between more valid designs within one project or also to compare data between other defined valid designs from other projects of (same) user. If user will specify specific final valid design as public data, other users will be able to find these public specified valid design and compare them with their design.

=====

D_UC002 Validate Design Criteria

No.	Actor	Activity	Condition
1.1	User	Login to function <i>Validate Design Criteria</i> by marking specific property, data, product kind, etc. and with right-click menu list select this function.	
1.2	User	Or User can Specify of all elements for “freeze” and validate design criteria from simply checking them from the table list	table list of concept elements and properties must be prepared
2.1	System	System after receiving signal <i>Validate Design Criteria</i> will ask, to which existing <i>Valid Design</i> it shall be saved in, or gives possibility to create new Valid Design with new name.	in the case of saving data to to existing valid design, there can be only one value within each saved attribute, which can be only replaced
2.2	System	Gives an opportunity to <i>Compare and Analyze</i> the saved Valid designs	If User needs to use these functions, it shall be specified the comparing data or analysed data

Concept Analysis function D_UC003

Use case name : Concept Analysis
Use case Identification : D_UC003
Actor : Designer
Restrictions : Actor is not logged in system
Other functions cannot run in main screen (background only);
Actor is not authorised for specific process application

=====

Concept analysis will be consisting from various possibilities either with combination of embedded applications with or without collaboration with (Ag) actor (this will be more described in the Agent-Solver (Ag) Actor functionalities description), or by help with imported data possibility from/to other simulation programs such as EnergyPlus, esp-r etc.

Frankly told, full description of this function exceeds this work and will be continuously upgraded and developed. Described function in this work will only consists from Analysis of concept specifications created with D_UC001 Conceptual Design function. But thi is only analysis of the systems analysis. It is necessary to mention, that for non-system analysis - envelope of building (glazing, shading, insulating, DSF-double skin facades, roofs etc.) analysis must have other specific way to prepare analysed results. As mentioned, in this step will be necessary to obtain result data from other simulation processes mainly.

There can be space and is potential for further development basic building evaluation function for the energy audit of buildings within *Concept Analysis* function.

=====

D_UC003 Concept Analysis

No.	Actor	Activity	Condition
1	User	User Log and select function, select project wo which shall be Analysis associated	
2	System	Offer available analysis possibilities	Specific project input is set. e.g. specific concepts with specified elements
3	User	Select one of some possibility and awaits for results	
4.1	System	Gives results	
4.2	System	Offer the possibility to save and compare results	

Case study No.1 of Whole Design process within all Designer functions :

Case study scenario : Let’s imagine that designer of the cooling system is using the IS for design specific cooling system and let’s look into Figure WF.03 for describe his work. Designer already selected specific conceptual scheme in the first step of design which he did approve and now he is creating the exact design of elements inside. He did in the input basic data of the initial phase of the design process, which is 250 kW of cooling capacity of system and he knows, he wants to use 5,1 kW and 3,2 terminal units - for this case fancoils. These data are the inputs in table 4, where 5,1 and 3,2 values are specified as well as their amounts, 17 pieces of 5,1 kW units (86,7 as subtotal of this selection) and 45 pieces of 3,2 kW units (144 kW as subtotal). He selected these two types of terminal unit for the examination within design and with marker in “Use” column he marked them so total cooling capacity was computed and in N/A row is shown that till 250 kW of needed capacity is with this selected terminal units missing

19,3 kilowatts. Because designer did not yet specify the heat-pump (chiller) type, required data for selection the Heat rejection unit (units) are not known, even for example designer can know he will likely more dry cooler than cooling tower.

Designer now knows he needs to add more fancoils to fill the 19,3 kW gap but now the selection has prepared for defining the pump(s) on primary circuit for gaining water. Let's assume the temperatures for primary circuit are already set (during the fancoils 5,1 and 3,2 kW selection) and we know the cooling capacity (250 - 19,3) as well as the temperature difference (i.e. 6 - 12 °C), so waterflow is known. Besides other specification requirements for pump, the most important for the pump specification is now required head pressure (external pressure) which will be the final value of the pressure drop of the highest pressure drop way within the system. This is the sum of the longest pipe way with the highest fancoil pressure drop installed on it and pressure drops of installed elements on circuit (in this case only one three-way valve and evaporator in the chiller) designer now have two ways how can he continue - either he preset some numerical values of non-selected pressure drops of non selected elements as an assumptions or he firstly selects the chiller (according basic requirement 250 kW) and valve. The choice is upon him. The piping data inputs (pressure drop, friction of material, positions of other elements within it thus computation the lengths) may be but not necessarily need to be input from the BIM design (by G_UC008 *Data Import/Export* function) where the necessary computation data will be extracted from the IFC model of the piping system. Important is fact, that the total pressure drop of system which relies on the piping and other parts of piping selection is the basic design input for the pump selection as input value *head pressure* which shall be hither or at least equal to the computed whole pressure drop in the primary circuit.

Wireframe example of Whole Design process page:

Specific example of the design window in the phase of elements selection is created by more adjustable parts. It is assumed, that user may to move or hide each part according his needs on the screen.

Design : project XY - Variant II.

Search

Library	Qcool Subtotal (kW)	Amount	Qcool total (kW)	Use	Actions
[-] Cooling Source	250	1	250	<input checked="" type="checkbox"/>	Edit View Select
[-] Terminal units	250	1	250	<input type="checkbox"/>	Edit View Select
[-] Fancoil 1	5.1	17	86.7	<input checked="" type="checkbox"/>	Edit View Select
[-] Fancoil 2	3.2	45	144	<input checked="" type="checkbox"/>	Edit View Select
[-] N/A	N/A	N/A	-18.3	<input checked="" type="checkbox"/>	Edit View Select
[-] Heat Extraction	??	1	??	<input type="checkbox"/>	Edit View Select
[-] Flow		1		<input type="checkbox"/>	Edit View Select
[-] Pump 2		2		<input checked="" type="checkbox"/>	Edit View Select
[-] Pump 1		1		<input checked="" type="checkbox"/>	Edit View Select

Specific Libraries: Schemes Products Inputs

- Databases
 - Heat Pump
 - Heat Extraction
 - Terminal Units
 - Fancoils
 - Cooling Beams
 - Pumps
 - Cooling system pumps
 - Double pumps
 - Single pumps
 - Heating system pumps
 - Grey water system pumps

Influence Data: Table Diagram SmartWindow

Attributes Products Professions

Influenced by
 Influencing
 Piping
 Dry Cooler
 Regulation Valve

Amount: []

Product Attributes:
 Basic
 HeadPressure: 180 kPa
 FlowRate: ?? L/s
 Power: 12 kW (max)
 Connection: DN 40

Save
 Compare
 OK

HeadPressure Efficiency Dimensions Control

Figure 8. Available head pressures - High head pump - High Efficiency - Compact and Super quiet

HeadPressure: 180 kPa
 FlowRate: ?? L/s
 Power: 12 kW (max)
 Connection: DN 40

Manufacturer
 Type
 090 HE-MM
 090 HE-MM
 100 HE-MM
 130 HE-MM
 120 HE-MM
 140 HE-MM

Pressure Head (m) vs FlowRate (L/s) graph showing performance curves for various pump models.

System Elements:
 Heat Pump
 Dry Cooler
 Pump (Extraction)
 HeadPressure: 180 kPa
 FlowRate: ?? L/s
 Power: 12 kW (max)
 Connection: DN 40
 Pump (Primary)
 Regulation Valve (Primary)
 Regulation Valve (Extraction)
 Terminal Unit

Figure WF.03: Wireframe example of the Design page (Specification elements design phase), source: Wireframe Sketcher Studio design

Above on the Figure WF.03 are graphically specified implemented functions for Designer's work. Description of its supplements follows :

- 1 - You can see the actual selected step within the design process and to change specific steps within process (System / Elements / Analysis / Comparison / BoQ / Validate). The screen functions change according design step
- 2 - process step edit and save functions. There will be an opportunity to go back X steps, save the design situation with specific name as specific variant with text description and go back behind X steps.
- 3 - Classic search window, which will be connected by any of searchable value on the screen simply by clicking possible value with specific key (i.e. *ctrl*) and clicking back to search window with holding the specific key. This process will inform the user to taking order by drawing the (i.e. red dashed) segment line between the searchable value and cursor, leading to click for search window
- 4 - Data input window, where can be selected specific attributes of elements for input data. Also amounts of products can be added and subtotals of their specified values (i.e. total cooling capacities of total amount of more types of products) Some data inputs are visible (and adjustable) throughout this window with graphical explanation on the table “17” (can be switched to different value on the tabs “19”) as well as seen on the “15” screen.
- 5 - Libraries of schemes, products and possible data inputs to products. It represent searching window of *D_UC000 Search Libraries* function. Product library tab on this page may be a defined by results from basic search window results of *G_UC001*, which are forwarded to design process. Further on the “Inputs” tab you can specify inputs which are used for product selection (in the meaning of physical equations, i.e. in the attributes on equation $Q = m \cdot c \cdot \Delta T$ can set either capacity with delta T, or capacity with mass flow but not all together). The input values of all product in system may be defined in specific “chain” of input = output values, where output values of first product will be input for another product with possibility to use mathematical relation with other data during preparing inputs to other chain part (i.e. output which will be input for next product in line would be multiplied (or divided, added, deducted) by some specific other value or next variable based on other inputs).
- 6 - Influence data tables - data information table “7” visual selection - You can select different visualization forms - the tabelized data informations, relationship diagram or smart window with roller rows
- 7 - Data influence tables shows basic influences of products, attributes and professions affecting specific element selection or affected by other element, attribute or profession. It affects either data of inputs/outputs which are affected of other specific product selection and its attributes (shows which attributes) or which are affecting other specific product in the elements selection (or different products from different profession outside the selected scheme). Thus these relationship data must load the relationship map of specific products.
- 8 - Focus zoom roller change the detailed data of the concept scheme “9” from basic simple conceptual scheme to less or more detailed object class model with shown or hidden specific attributes
- 9 - Graphical scheme of concept. It can be shown by more expressions manipulated by “8”

- 10 - Scheme elements roller for specification input data and determine specific industrial product (in “18”) after validating selection in 17; 20; 21; 15; 12; 14.
- 11 - basic other step possibilities, save selection for further use in different project or as variant in same project, compare product with G_UC003 function, and approve selection
- 12 - setting the number of specific product in the system. (may be grayed out if number will be set as variable value based on different outputs). The same value input you can specify in the table 4 in the *Amount* column
- 13 - the list of general IFC object (product) attributes as well as extra attributes which varies from manufacturer to manufacturer, each section specifies separate group of attributes of the element
- 14 - similar function like 10 brings the tabelized list of system elements
- 15 - windows for input data attributes. Roller is used if there is larger amount of rows as height of the open window
- 16 - roller for fast rolling between the element parts, possible to change it also with keys *right* and *left*.
- 17 - graphical data of product properties may be help during the selection process thus is implemented. Graphical explanation of data will be set by basic product data templates but may be modified by specific user for his purposes
- 18 - exact product, manufacturer or even modification selection window, where by selecting specific product you can evaluate influence on whole system (with help of compare function)
- 19 - more tabs of more graphical explained attributes of the product
- 20 - specified data inputs mirrored from the 15 adjustable from this place also
- 21 - possible ranges of the values predefined by technical limitations of the system (i.e. in pump of heat extraction circuit will be the min. and max. flows limited by min. and max. flows of condenser of the specified heat-pump (chiller), which will be also mentioned in the 7

Authority (A)

As mentioned in the Approval Process G_UC000 description, deciding process (or Approval process) is one of the most used processes within the building process as well as within spatial and development policy planning. Therefore is clear the necessity of many levels Authorities involving in these processes. Authority role in the IS will mainly use the “*decisionmaker*” status and roles within specific IS thus building processes according the reality.

It is necessary to mention, that on each market region (country) can be the administrative process involved in construction industry different. IS shall be able to be modified according specific local administrative processes structures which are in compliance with local law regulations and create specific processes structure and harmonogram for each region.

Authority will thus can use them and modify them according to its needs.

Authority activities can be basically divided into *internal* and *external processes*, and *multi-scale spatial planning* and *micro-scale building processes*. External processes are all the communication with an external subject due the construction project development either on micro or macro scale point of view. Internal processes may be initiated by the external process and involves all the authorities necessary for resolving the external process or authorities necessary for resolving internal issue i.e. change of technical normative, change (fasten or simplify) the cooperation process.

Authority (A) functionalities

Supporting applications for effective urbanisation in the Multi-scale urban planning are out of the scope of this work but is necessary to mention it importance for the sustainable development urban processes all around the globe. When the IS will have good list of valid geographic data layouts and agents prepared to coworking, it will give high value to the efforts of sustainable planning.

- Store and modify regulations (technical, law)
- Spatial planning support functions
- Administration of building process
 - Macro - spatial design approval processes (i.e. spatial plan approval process)
 - Micro - Building phases approval processes (i.e. building permit approval)
- Multi-scale planning data access

Examples of databases necessary for multi-scale planning

- population density
- population growth
- Urban Amenities density and location,
 - cycling, walking distances computing
- population outlook and perspectives (migration, baby birth, education required, etc.)
- data for identification commercial and public service clusters
- geology map, water sources and infrastructure map, etc

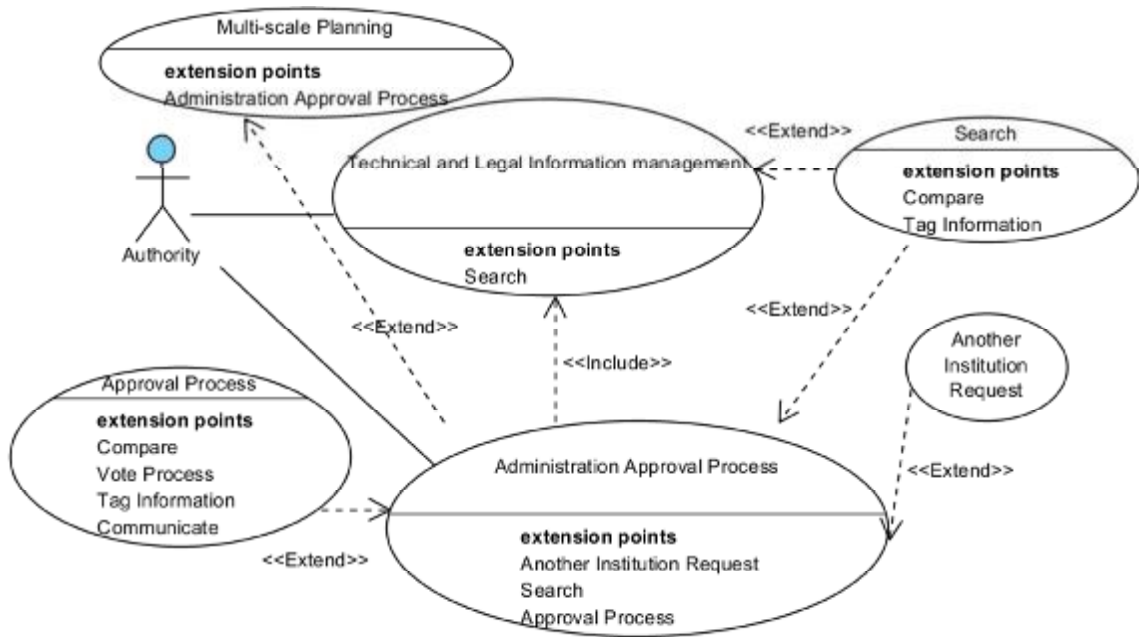

Figure U.4 : Use case diagram for an Authority official as an actor, source : Diaportable graph design

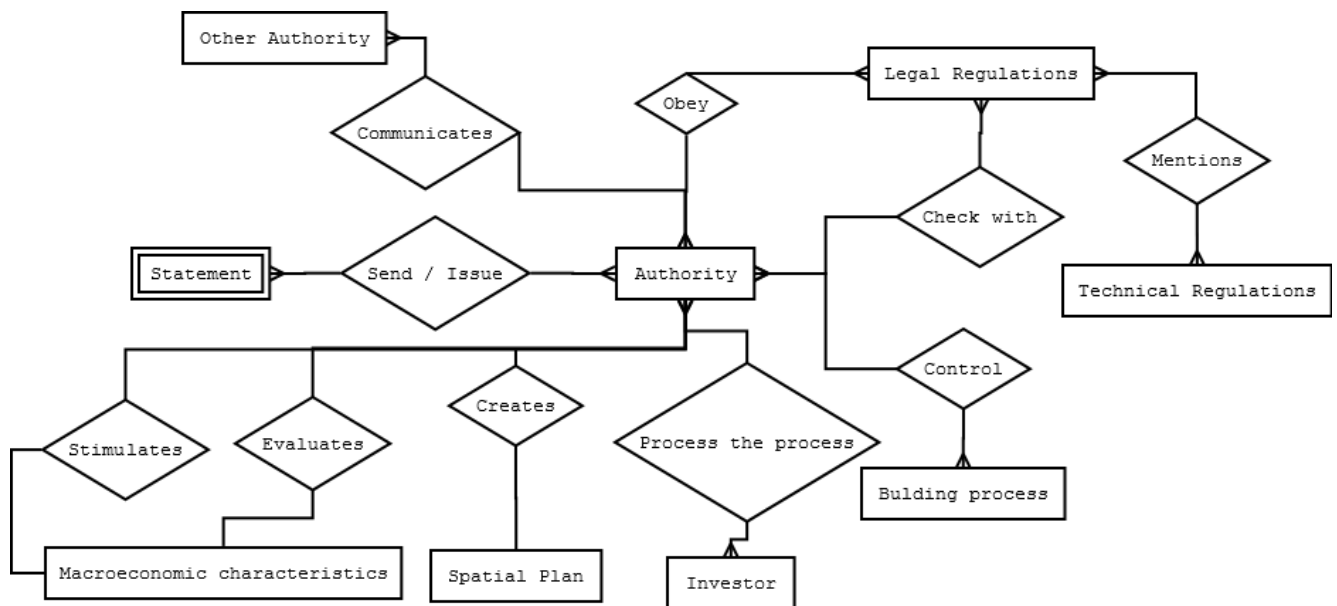

Figure ER.3: Entity Relationship diagram of Authority official roles as an actor in IS thus in building process, source : Diaportable graph design

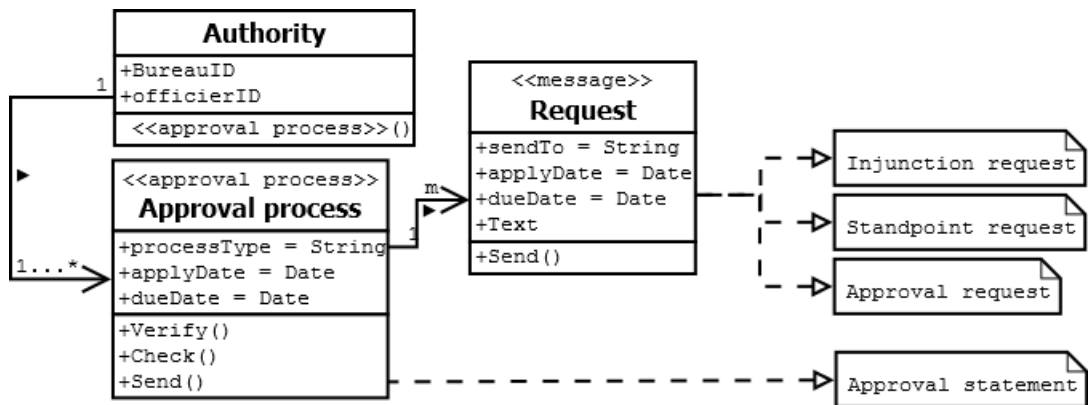

Figure C.4 : Class diagram with structure for data storage of the Approval process for an Authority official as an actor, source : Diaportable graph design

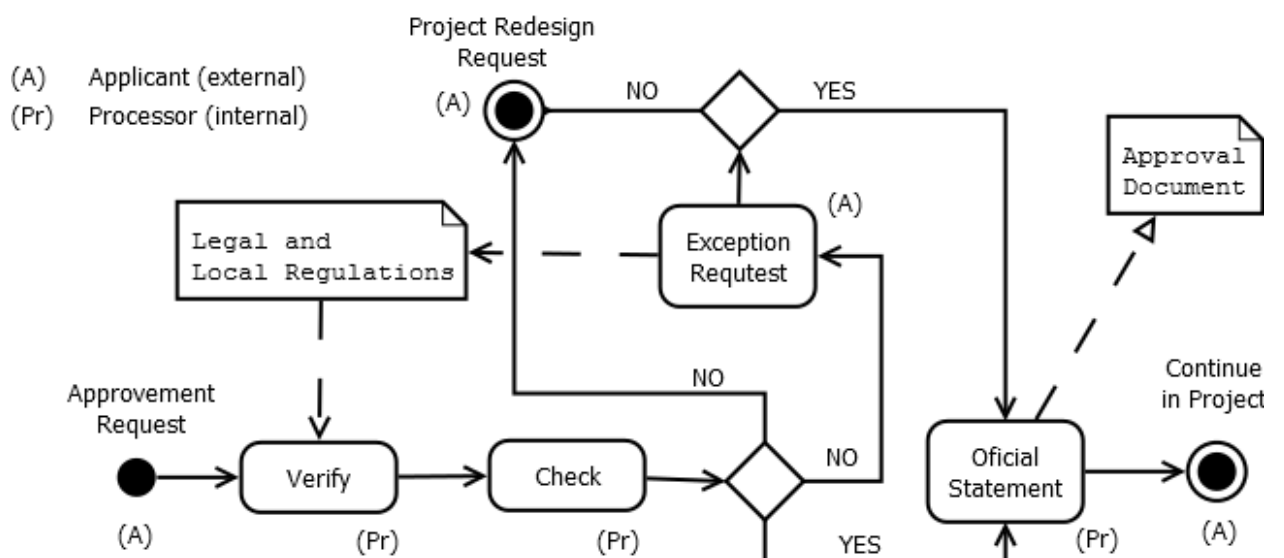

Figure A.3 : Activity diagram focusing administration approval process of Authority more deeper, source : Diaportable graph design

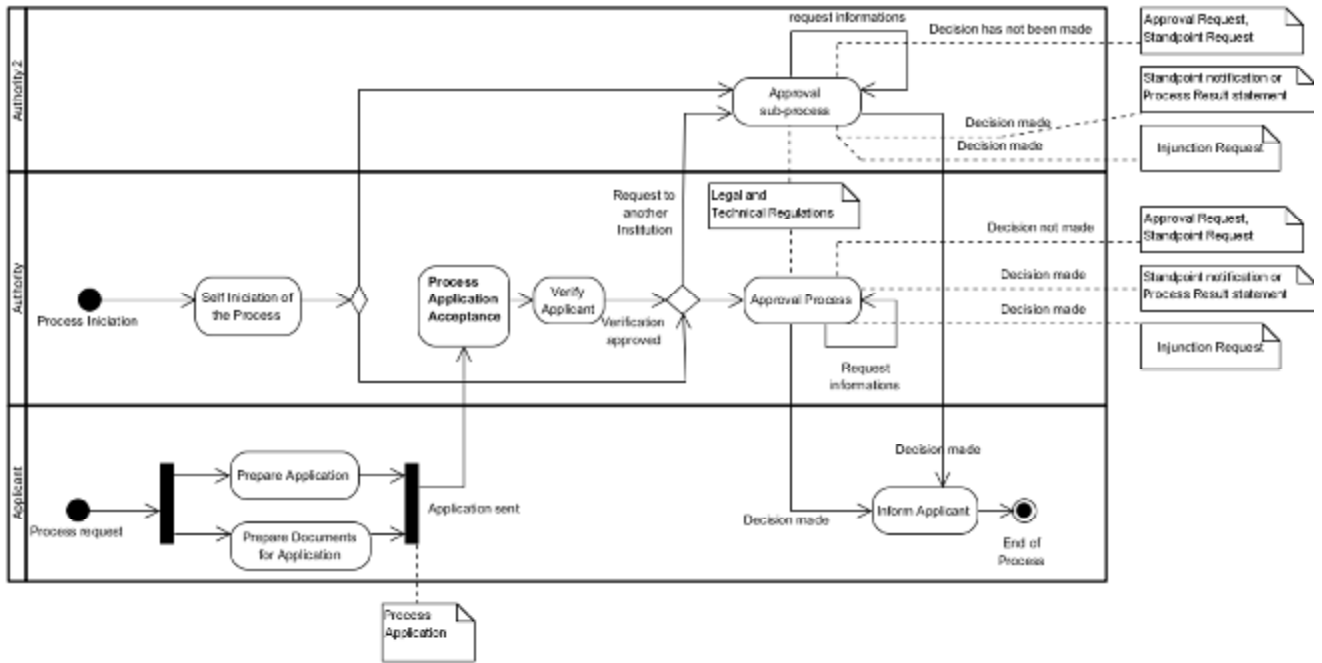

Figure A.6b : BPMN diagram of administrative process direction for an Authority official as an actor. Diagram is answering questions about who initiates the process and who will be asked to participation within *internal administrative sub-processes* part. Source : Visual Paradigm design

Technical and legal regulations management function A_UC000

- Use case name : Technical and legal regulations management
- Use case Identification : A_UC000
- Actor : Authority
- Restrictions : Actor is not logged in system
Other functions cannot run in main screen (background only);
Actor is not authorised for specific process application

=====

Authority as a specific actor which has legal right to change specific contents of specific law or technical documents over time. The necessity of time-change of documents needs to be mirrored into text databases flexibility, where only Authority (and Admin of course) will have the read/write access according the practice in the real world. Other actor roles shall use text databases only with “read-only” access rights to the data.

Authority will obtain possibility to create and edit text documents according its institution focus and competency, as well as ability to manage its structure, potential language mutations, time-variants and its status (i.e. *valid, non-valid, cancelled, in preparation* etc.).

It will be necessary to import/export document files to databases with known filetypes.

For normal use of the text databases for administrative approval processes it will be used function G_UC000 *search*, modified for Authority roles purposes.

=====

A_UC000 Technical and legal regulations management

No.	Actor	Activity	Condition
1	User	Login and select function	
2.1	System	Offer text libraries to select from	
2.2	System	Offer to create new document	
3	User	User either selects specific library, and document to edit or create new document	
4.1	System	Opens selected document or create new one and offer specific operations for editing	
4.2	System	System will require basic document information : Name, annotation, documents group to include in	Create new document was specified
5	User	User edits documents, saves the actual edition with appropriate change edition informations	
6	System	Save actual edition and go back to step No. 2	

Administration Approval Process function A_UC001

Use case name : Administration Approval Process

Use case Identification : A_UC001

Actor : Authority

Restrictions : Actor is not logged in system
 Other functions cannot run in main screen (background only);
 Actor is not authorised for specific process application

=====

Traditional necessity of improvement the private and public building development by the Authority (BCA - Building and Construction Authority) has its reason. Frankly it may still stands on old procedural forms which are time and costs consuming. This Function will offer efficient solution how to faster the approval process and be more appropriate within his decision results.

Again as mentioned more times before, this function will offer to user an advantage of the use of specific data when the are required and with appropriate quality in a relatively short time.

Second value of this function integrated in the IS will be possibility to allow the processes results and steps being publicly released and accessed in the philosophy of transparent administrative processes and Open Data philosophy, to whom anyway many governments already gave their support.

=====

Au_UC001 Administration Approval Process

No.	Actor	Activity	Condition
1	User	Login (self define as type of Actor)	
2	System	According type of role, system will offer possible process list to start (initiate)	actor specified
3	User	User will specify process to initiate	
4	System	System will ask for project to associate the process with	process specified
5	User	User select project to associate with process	
6	System	System will ask for all necessary required data, documents, other approvals (sub-approvals) for process Application	project associated
7	User	User will submit all necessary inputs for application	
8	System	System will offer list of all possible recipients of the Application	all inputs submitted
9	User	User specify recipients and send an Application for next phase submittal	
10	System	System accepts an Application, send it to the recipients for starting the <i>Approval Process</i> : A_UC000, and saves data log of this operation, as usually	

Note: Sub-approval process is process which precedes the actual process.

Technical and legal regulations management function A_UC002

Use case name : Another Institution Request
 Use case Identification : A_UC002
 Actor : Authority
 Restrictions : Actor is not logged in system
 Other functions cannot run in main screen (background only);

Actor is not authorised for specific process application

=====

This is simple function which will be referred in the case of need by approval process processor to forward informations and request to react different institution or other person within the same institution. A_UC002 is integrated together with A_UC001 and G_UC000.

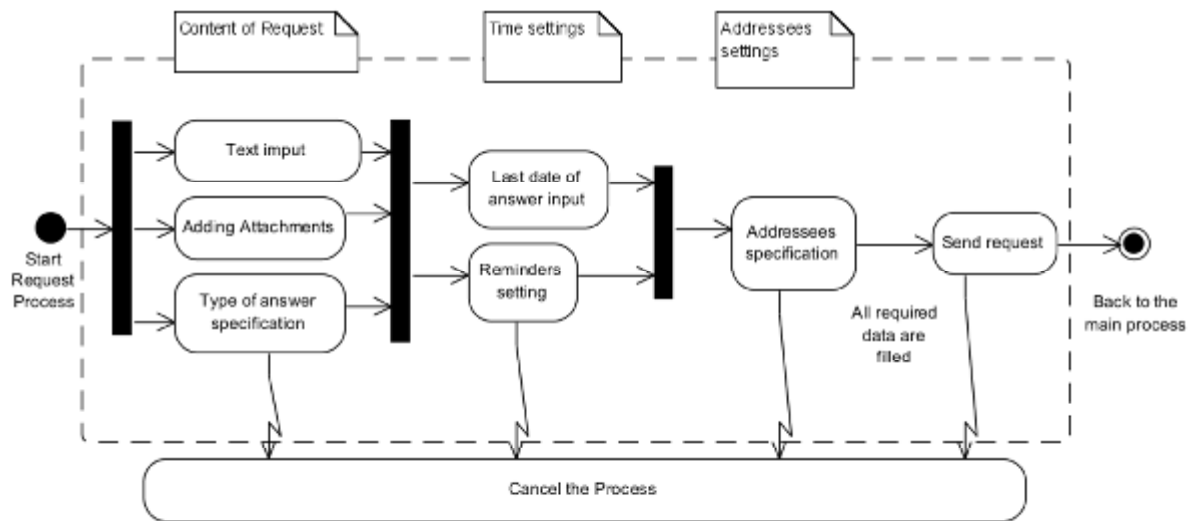

Figure A.18: Activity diagram of the Another Institution Request function, source : Visual Paradigm design

=====

A_UC002 Another Institution Request

No.	Actor	Activity	Condition
1	System	Will jump from the G_UC000 or Au_UC001 to new form where ask for addressees specification, confirm the last date of requested answer and reminders settings, ask for type specification of requested answer and offer to add text message with joining attachments.	
2	User	Will fill up full the request form	
3	System	System sends requirement. end of process. System sends the user back to the main approval process	all requested data are filled

Controller (Con)

Controller is playing usually kind of “third party” control and intervention. Third party expert of specific part of project is invited for controlling the design and comment it within the process. He wether allow or deny the prepared concepts or designs and without his permission, project must stop and cannot go on till he will be modified and revised. Controller function can be created by other roles (designer, contractor) as well or can be sent from the Building and Construction Authority. “Site control” or better told *Construction supervision* is usually available for controlling the correctness of working procedures and results of construction works during the whole construction process.

Controller has opportunity to use the “*decisionmaker*” status in specified cases in IS processes. For example, controller within designer organisation can be BIM coordinator coordinating all disciplines designed in BIM model or controller the correctness and validity of specific profession design, which is very common.

Controller (Con) functionalities

For the fulfilling the role of controller, all necessary processes are already mentioned in the the work, to list them : Approval process G_UC000, Search for information G_UC001, Communication G_UC002, Compare G_UC003, Tag G_UC004, Manage Data G_UC007, Concept Analysis D_UC003, Monitor Processes G_UC009.

Contractor (Ctr), Subcontractor (Sctr)

General contractor wins tender set by investor, or his deputy. Subcontractors won tenders set by general contractor. Both of them, Contractor and Subcontractor aims to successfully finish the project with the lowest costs and with highest revenue as typical commercial subjects, for which reasons needs to cut their costs by selecting and using lowest possible workforce, materials and technology, which will complete construction in accordance the design.

They have the need to use the “*decisionmaker*” status (Figure MC.1 in *Definition of specific processes* paragraph) article in many cases in IS processes.

To summarize the Contractor and Subcontractor, their needs will completely fulfil the functions of General Actor as shown in Figure U.5 but constructed to specific role. That means this role will have its own profile pages for manipulating data and process informations where General functions will be implemented for use.

Contractor (Ctr) , Subcontractor (Sctr) functionalities

- Manage Data
 - Managing the bills of quantities : comparing, create alternatives
- tendering bills of quantities on the market
- Monitor activity of subcontractors

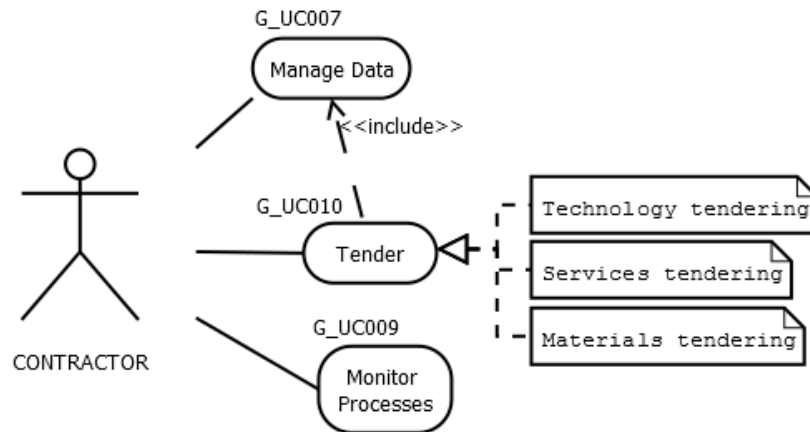

Figure U.5 : Use case diagram for Contractor as an actor. These functions describes main needs of contractor but all of them are specified within General Actor role source : Diaportable graph design

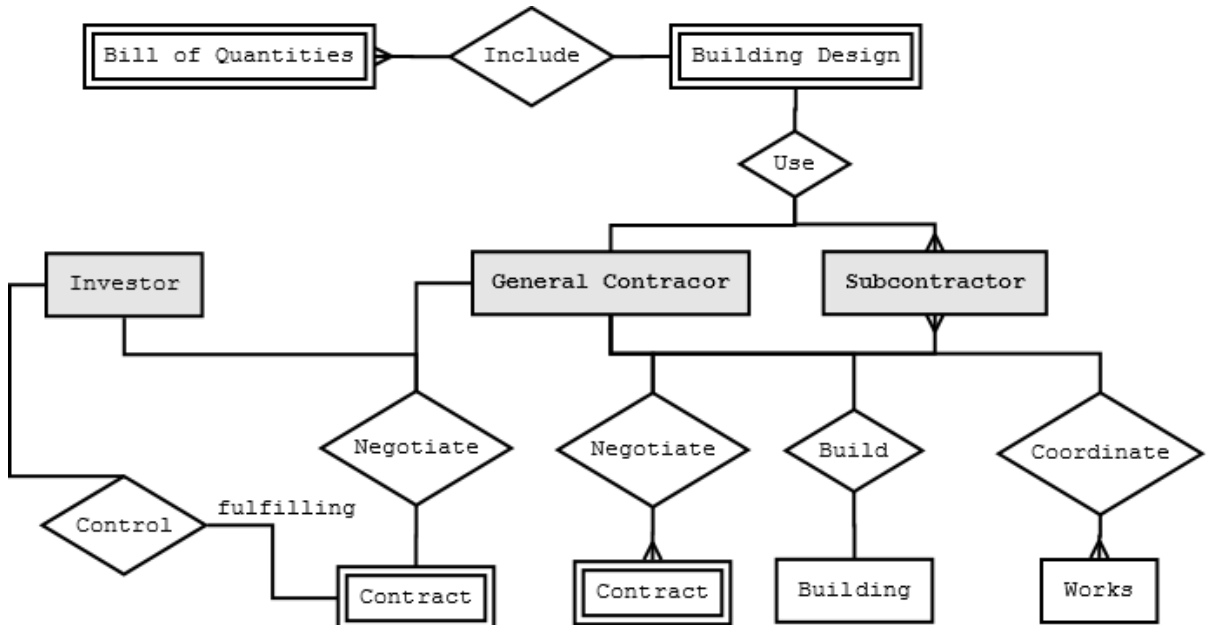

Figure ER.4 : Entity Relationship diagram for Contractor as an actor, source : Diaportable graph design

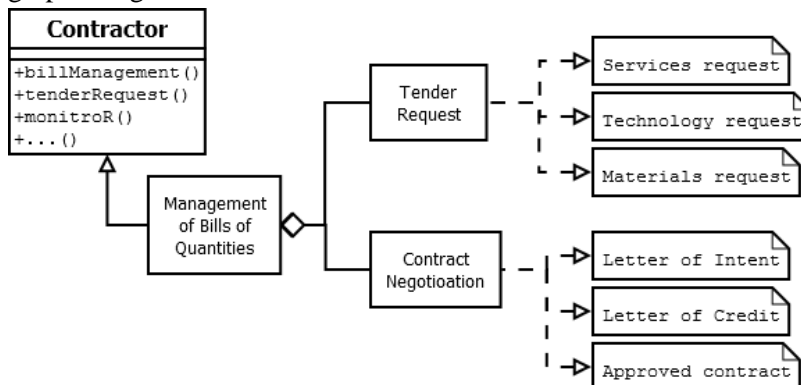

Figure C.5 : Class diagram with specified functionalities for Contractor as an actor, source : Diaportable graph design

Functions for Contractor and Subcontractor are basically below General Actor functions as combination of *Manage Data* and *Tender* functions but modified for the purposes of the Contractor and Subcontractor Needs. This provides the ability to compete and win tenders by sending and winning the Tender selections for gaining the contract. Most important document for this - Bill of Quantities is forwarded from Designer role, passing through other roles in the process chain. BoQ data flows in the philosophy of Figure S.2 and Figure SD.1, and is based on processes A_UC007 *Manage Data* for data management and G_UC011 *Tender* function for tender manipulation (General actor functions)

Supplier / Industrial manufacturer (S/M)

Industrial manufacturer or supplier is important player during the construction process. His activities (material and technology deliveries) are affected both in macroeconomic payment balance of local economy as well as in the budget of total costs of project. He influence the highest volume ratio from the total investment cost described by flowing the capital from investor to buying the project. He also influences the further operation costs during the lifecycle of objects thus selecting of appropriate materials and technologies has crucial impact on future business plan cash flow (mainly costs or also savings respectively) and the business plan (investment) evaluation processes.

S/M's main aim is to deliver (sell) his product to continuously receive the revenues to fulfill his own business plan. Main contribution of the IS for this actor is to support his sales promotion and its tendering cost lowering by improving tendering processes within building projects.

The purposes of the functionalities for S/M is thus product portfolio data management and availability of the fast and easy data update for sales support as well as to obtain important informations for creating and modifying the business strategy.

Tender applications and preparing tender proposals are in the range of *G_UC010 Tender* functions of (G).

Supplier / Industrial manufacturer (S/M)

- Product data management
 - product specification
 - product Lifecycle analytics (not further specified in this work)
 - Sets additional criteria for product handling
- Demand trend analytics and Business Intelligence functionalities
 - *Application based on specifically prepared modules for the Use to help with S/M user with his business strategy. The scope of this work does not describe Business Intelligence functionalities.*

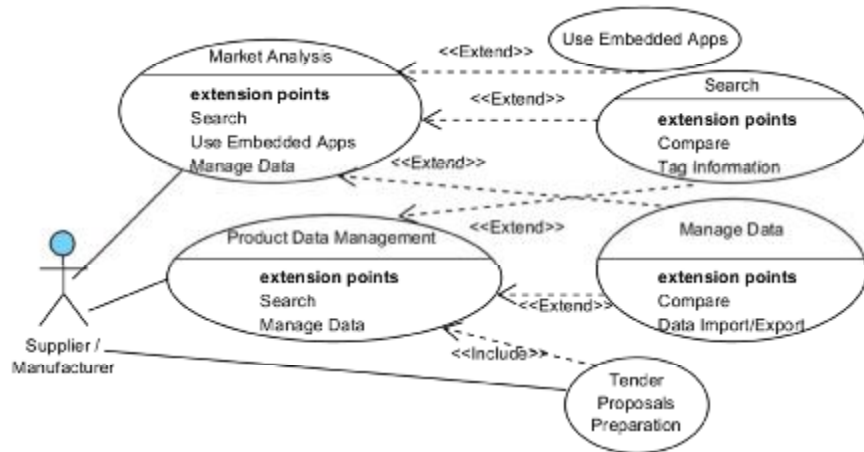

Figure U.6 : Use case diagram for technology or material Supplier as an actor, source : Diaportable graph design

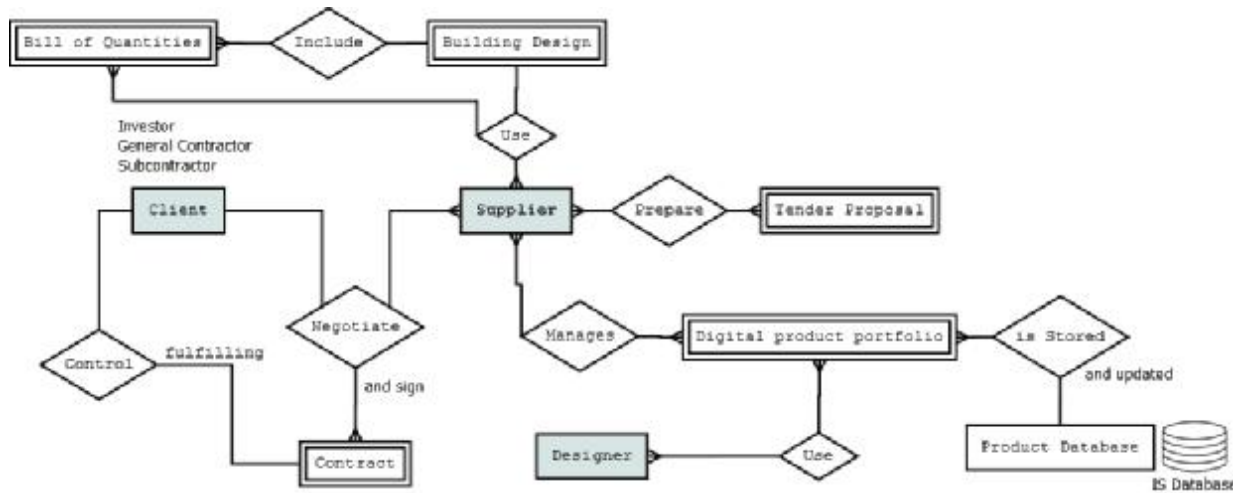

Figure ER.5: Entity Relationship diagram for technology or material Supplier as an actor, source : Diaportable graph design

Product Data Management function SM_UC001

- Use case name : Product Data Management
- Use case Identification : SM_UC001
- Actor : Supplier and Manufacturer
- Restrictions : Actor is not logged in system
Other functions cannot run in main screen (background only);
Actor is not authorised for specific process application

=====

Product Data Management is core function for the S/M actor. It gives him full responsibility and operation access above his product portfolio.

SM_UC001 includes full *Manage Data G_UC007* function package extended by *G_UC003 Compare* function , *G_UC008 Data Import/Export* function and *G_UC001 Search* function. The last named function - search function is giving the possibility of graphical expression the technical product data if need. Tender applications and proposals will be done by *G_UC010 Tender* function, see *G_UC010* description and Figure A.8.

All of mentioned functions will be implemented within the user page of S/M for his efficient work.

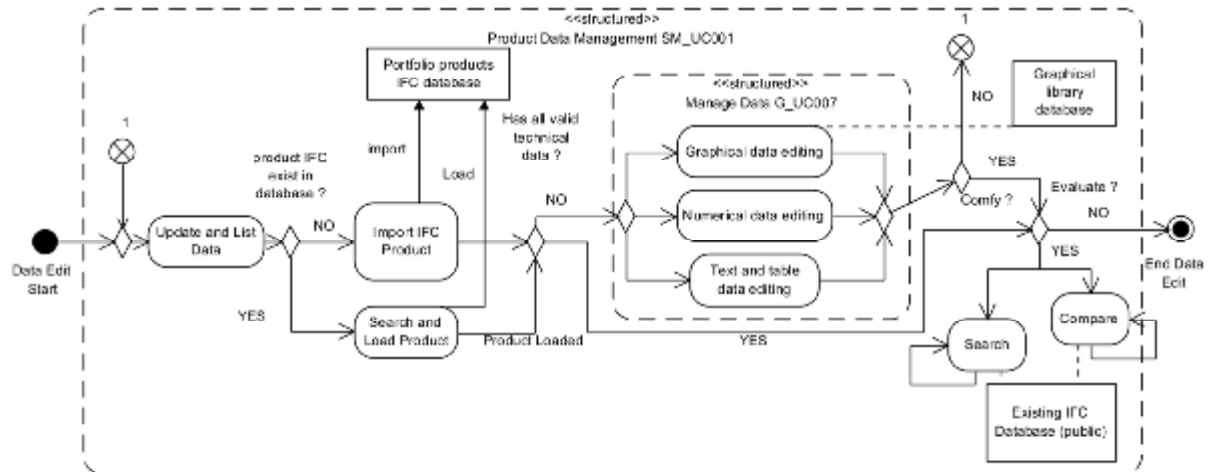

Figure A.14: Activity diagram of the Product Data management activity flow, source: Visual Paradigm

SM_UC001 Product Data Management

No.	Actor	Activity	Condition
1.1	User	Login (self define as type of Actor), initiate <i>Product Data Management</i> function.	
1.2	System	Show the list of product portfolio data, User may click update button for update the data (is possible that some data are freshly saved and not visible in the list)	
2.1	User	Import IFC data into database	Required product does not exist in database
2.2	User	Search and load the product for editing	Required product exists in database
3.1	User	User can either edit and import numerical data, text data or select graphical expression of existing data by selecting specific graphic template from the templates library and will forward to the evaluation decision node	Product does not have necessary valid technical data

3.2	User	User will forward to the Evaluation decision node	Product does have valid technical data
4	User	User can either use search function for searching different products from public database, or can specify data from selections for comparing with the own product	Search and Compare functions are requested by User
5	System	End of function, system will store the modifications and activity logs of user	

Market Analysis function SM_UC002

Use case name : Market Analysis

Use case Identification : SM_UC002

Actor : Supplier and Manufacturer

Restrictions : Actor is not logged in system
Other functions cannot run in main screen (background only);
Actor is not authorised for specific process application

=====

Market Analysis function is not specified more deeper but described just general. This specification may be part of the commercialisation of the IS within his Business Plan.

=====

SM_UC002 Market Analysis

No.	Actor	Activity	Condition
1	User	Login (self define as type of Actor) and initiate <i>Market Analysis</i> function	
2	System	System will offer possible <i>search, compare, and manage</i> data functions and <i>Embedded applications</i> functions for use. The range of the embedded applications for use is set by specific restrictions according business plan.	
3	User	User will use all the subfunctions embedded applications according his demand.	
4	System	System Offers required results, offers saving results and template settings of sub functions. System will save activity logs of user. Offers possibility to start Analysis process again.	

5	User	User saves templates and result data inside system. Ends the process.	
6	System	End of process.	

Operator (O)

Operator takes responsibility for operation, maintenance and repair works during the life cycle of object. It can be told that he is also user of building, in the matter of care of building indoor environment by controlling the HVAC systems. Life cycle costs of investment (building) are consisting in the high ratio from HVAC systems energy consumption over life period. These costs are a part of the *cash flow* of the entire business plan with influence of the results of the investment evaluation. The operator will be able to use IS for purposes of streamlining his work and giving him useful tool for efficiently monitor the costs and using operation experiences for decreasing him.

Monitoring, stored operation data analysis and utilization of them is the core of facility management data (Maintenance data management). Facility management company's activities can be divided to personal staff's or subcontractor's work daily duties and to controlling the technology systems hand in hand with their monitoring. Control of the systems can be realized through main BAS system or through local controls of separate system equipments. The IS will be prepared for situation when BAS control system will send packages of *event Logs* periodically for storing the history of systems operation in the database. Such operation and maintenance informations can be very valued also for design of new project systems which gives to designer the *experience* dimension.

Operator (O) functionalities

- Maintenance feedback function
 - get informations about breakdowns and failures announced by object user
 - part of Object User's role portfolio functions : U_UC001 (Operator's role is communicating and receiving informations)
- Indoor Environment Evaluation
 - Evaluates data (PPD index) sent by :
 - Object Users by voting
 - Computed prediction based on internal sensors data
- Monitor maintenance processes (connection to BAS control systems)
 - part of General Actor User's role portfolio functions : G_UC009
 - compatibility with BAS communication protocols
 - LonTalk
 - BACnet

■ Modbus

- Store maintenance data
 - part of General Actor User's role portfolio functions : G_UC007
- Plan maintenance processes - maintenance program

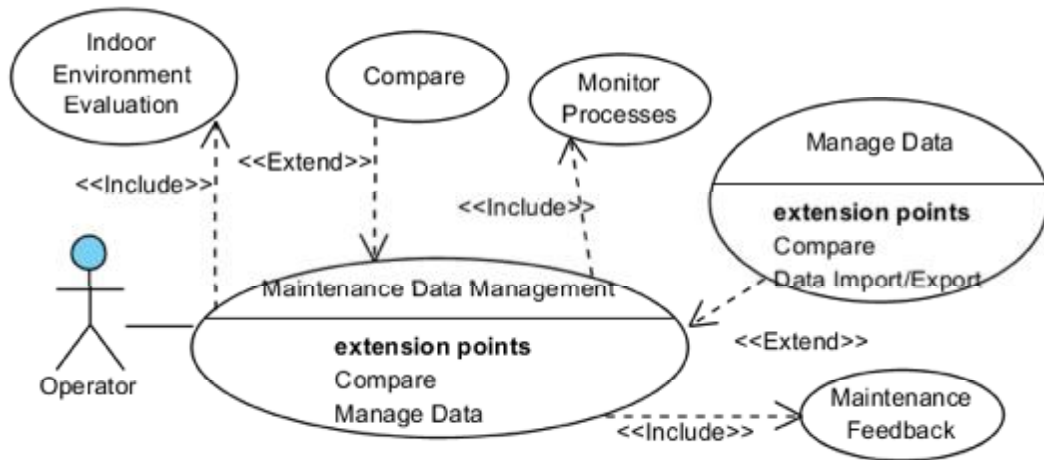

Figure U.7 : Use case diagram for Operator as an actor, source : Diaportable graph design

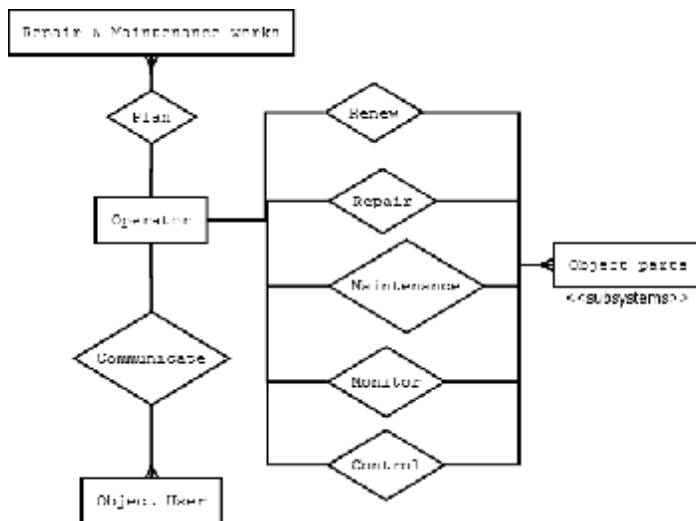

Figure ER.6 : Entity Relationship diagram for Operator as an actor, source : Diaportable graph design

Maintenance Data Management function O_UC001

- Use case name : Maintenance Data Management
- Use case Identification : O_UC001
- Actor : Operator
- Restrictions : Actor is not logged in system
 Other functions cannot run in main screen (background only);
 Actor is not authorised for specific process application

=====

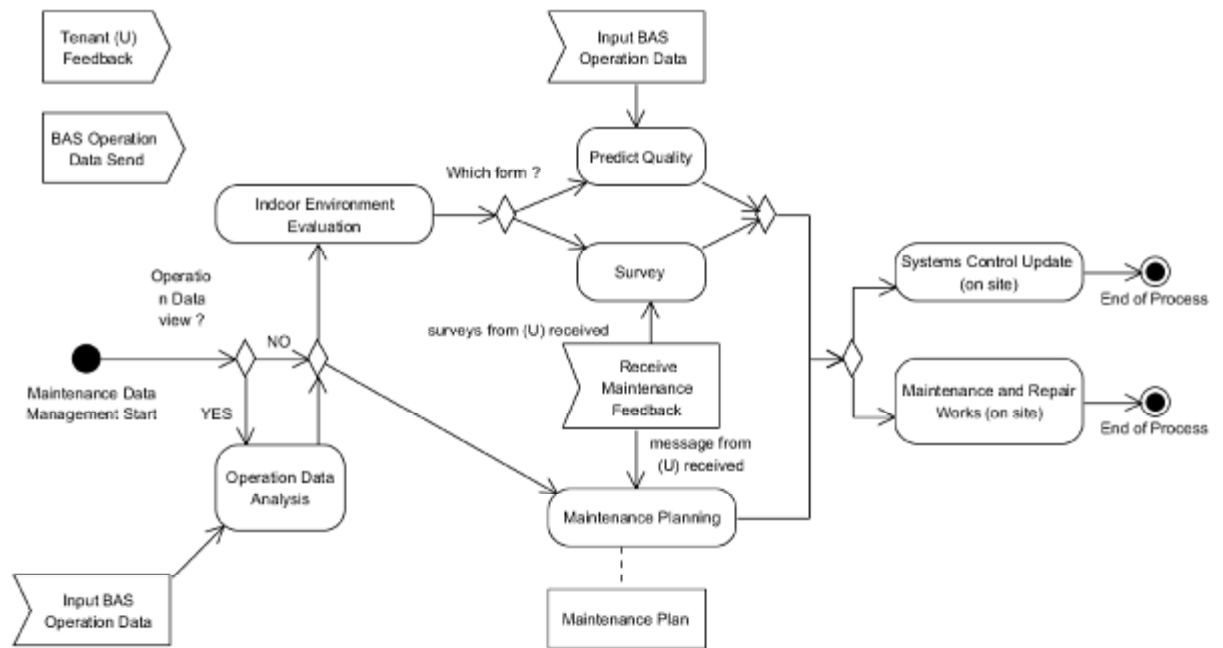

Figure A.17: Activity diagram of Operators main functions. This process is consisting from receiving information from the Object user Tenant (U) with U_UC001 function and with receiving informations either from BAS systems or from separate sensors where can be used Monitor processes function G_UC009.

Operators function *Maintenance Data Management* consists of three basic subprocesses which are based on the Operator's needs based on the relationships according Figure ER.6.

Operator need to communicate with more groups of tenants for receiving their feedback about indoor comfort and for receiving informations about building systems breakouts and failures. This communication is described with Figure A.15 and U_UC001 Maintenance Feedback function description. This communication touches Operator's two main aims - either taking care of internal comfort of tenants and taking care of full technical functionality of the HVAC and other duties.

Third Operator's need is to monitor evaluate the actual operation data as well as its history.

All of these needs and activities are directed for preparing the maintenance plan (on IS) which leads to final activities on site - systems control modification and maintenance and repair works.

Operation Data Analysis consists from the database of the operation data of building. It brings the necessity to connect the BAS system or local sensors with the IS for continually uploading datalog data packages as already mentioned in this work. Within this function shall be possible to search similar operation data with G_UC001 with setting graphical explanation of data as well as to compare with local or different operational data. Due to the necessity to connecting IS with BAS systems, shall be IS able to translate BAS communication protocol (mentioned in point informations in the beginning of paragraph of Operator functions).

Maintenance planning function shall work separately but able to absorb data from U_UC001, were all feedback notifications from the (U) user will be visible and

categorised according further criteria as *read, unread*, importance criteria as *critical, important, urgent, not important, etc.*, (user can specify his own importance criteria), and issue state criteria as *resolved, on-hold, not-resolved, solving*. This communication function has also possibility the G_UC002 able to transferring message communication between two sides of the process.

Important scope of the *Maintenance planning* function is ability of specific elements of HVAC systems to *speak up* for itself on behalf their necessity to ask for maintenance or repair (BAS needs to be connected to system). The condition of this self “whistleblowing” is to have appropriate HVAC system elements definition in IS in compliance with the installation in reality and also input necessary maintenance informations in the IFC object of elements, made by S/M actor - manufacturer of the product. For example, used IFC object has defined, that each 10000 operating hours, needs pump to be controlled by maintenance.

No matter this advanced function ability, questions like *Is the IFC model asking for maintenance the same as in building ?* or *Was the pump really operated for 10 000 hours ? How could You prove ?* will always be on the table.

Activities like *repair, maintenance, change, clean, check* (user can create his own activities) will be possible to be created within the *Maintenance Plan* in *Maintenance Data Management* function within *Maintenance Planning* activity. User can create and use more than one operating plan within one building. For each created activity will be set further attributes like times of the activity providing, time length of activity, it’s repeating frequencies, persons which are responsible for activity fulfilment, mentioned activity criteria above in the paragraph.

Indoor Environment Evaluation function O_UC002

Use case name :	Indoor Environment Evaluation
Use case Identification :	O_UC002
Actor :	Operator
Restrictions :	Actor is not logged in system Other functions cannot run in main screen (background only); Actor is not authorised for specific process application

=====

This function is based on the idea that occupants are dynamically interacting with their occupied building indoor environment daily under different conditions. It is prepared for the purposes fast and appropriate evaluation of the actual Indoor Environment Quality (IEQ) in the object. This information can be assumed as important factor for raising the value of whole building during tenant contracting leasing the space, if it will be resulting within acceptable values during long operating time. Occupants influence their thermal environment by the means of their clothing, opening windows and controlling the HVAC systems, using the sun shades. IEQ evaluation is measured by the means of PMV and PPD value (**101**), where PMV means

predicted mean vote and described as subjective feeling inside building in the range of *human thermal comfort*. *Thermal comfort* is the condition of mind that expresses the satisfaction with the thermal indoor environment of building objects or facilities assessed by their occupants and PMV is known as most recognized thermal comfort model which helps to operate HVAC systems within their goals. It can be measured by voting of building tenants within the scale of thermal feeling from the coldest to the hottest extremes. Naming them, from the subjective highest temperature +3: *hot*; +2: *warm*; +1 *slightly warm*; 0: *neutral*; and on the colder side -1: *slightly cool*; -2: *cool*; -3: *cold*.

Similar to ASHRAE Standard 55 there exist another comfort standards like EN 15251 and the ISO 7730 standards which definition will not be described in scope of this work. There shall be possibility to mathematically evaluate Thermal Comfort both

with adaptive method (applicable only for buildings without mechanical cooling systems with easily operable windows) as well with *PMV method*.

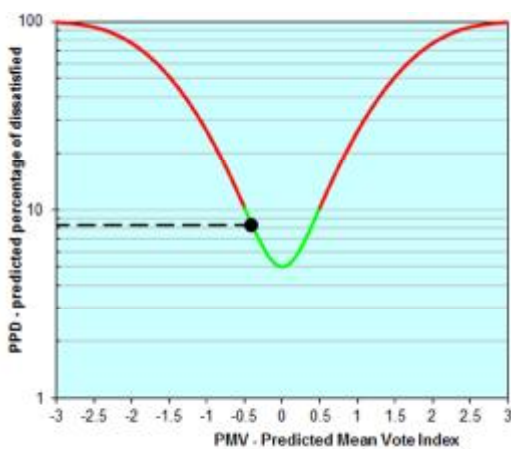

Figure D.5: PPD - Predicted Percentage of Dissatisfied persons index computed within excel module, Source: ASHRAE thermal sensation scale, ANSI/ASHRAE Standard 55-2013, Thermal Environmental Conditions for Human Occupancy, [27], [28]

Evaluation can be processed throughout two ways - predictive and consecutive with obtaining data from the tenants survey. Both of them shall IS provide to the user. Both ways are simply explained within the Figure A.16.

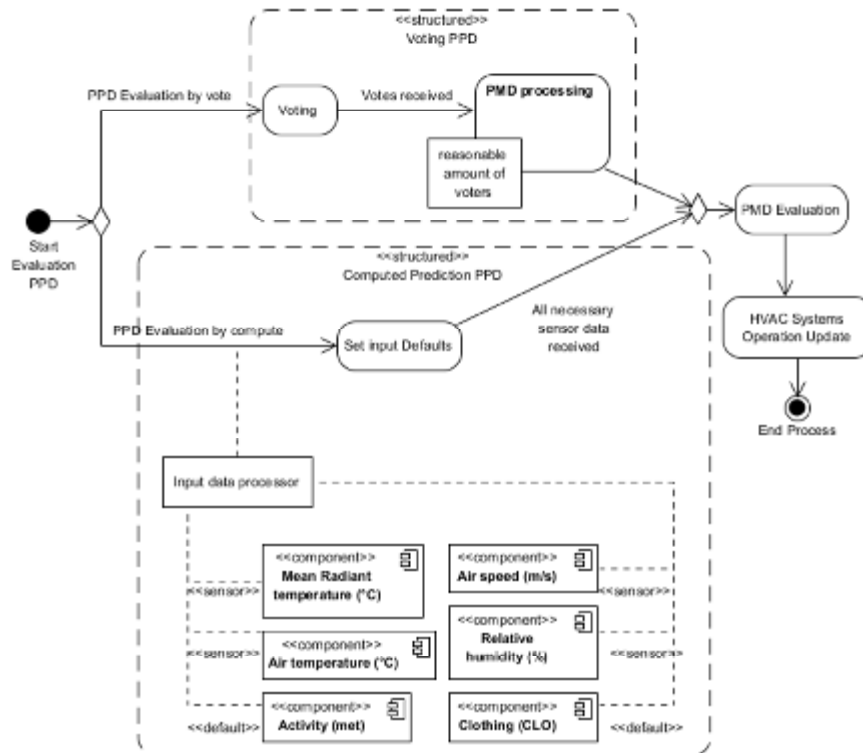

Figure A.16: Activity diagram of “Specify Indoor Environment Problem” part of Object User’s activity is Operator’s activity (PPD evaluation), source : Visual Paradigm design

Figure D.5 shows results of PPD by the computation module . Actual results show that indoor environment is slightly out of the best possible value (PMV = 0) and is slightly cold inside. It is common fact that approximately 5 % of all tenants in building are permanently dissatisfied by indoor environment even with PMV = 0. Input data for the computation of PPD are factors like *metabolic rate (met)* - energy generated from the human body, which depends of the type of activity the human body doe, *clothing insulation (clo)*- which is described as the amount of the clothes (thermal insulation) the persons are wearing, *air temperature (°C)*, *mean radiant temperature (°C) (MRT)*-weighted average of all the temperatures from surfaces surrounding by occupant measured by measured by black-globe thermometer , *air velocity (m/s)* - rate of air movements given in interior and *relative humidity (%)*. If the PPD will be required to be predicted by computation, operator shall install specific sensor of all of these physical quantities in specific spaces used for evaluation, and shall set specific default values for *metabolic rate* and *clothing insulation*.

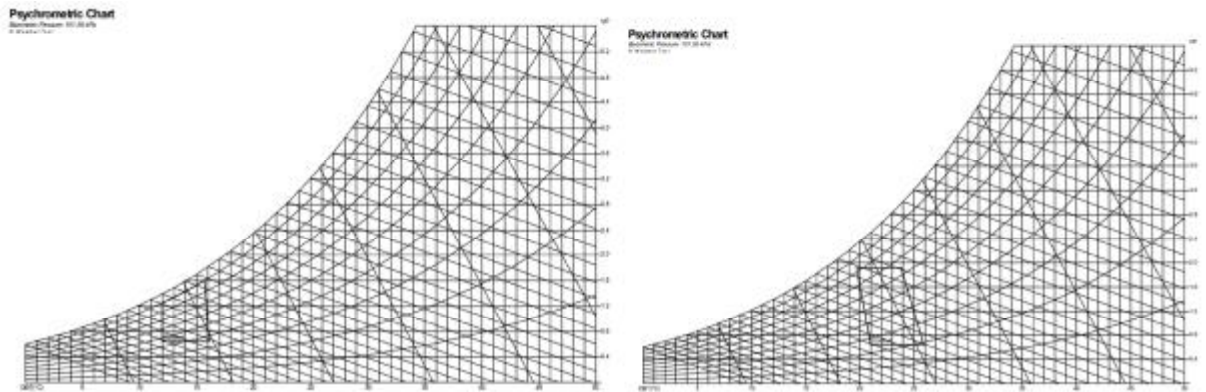

Figure D.6: Influence of the metabolic activity of tenants on the required indoor environment properties of air, source : Ecotect Analysis, Weather Tool, 2011 Autodesk

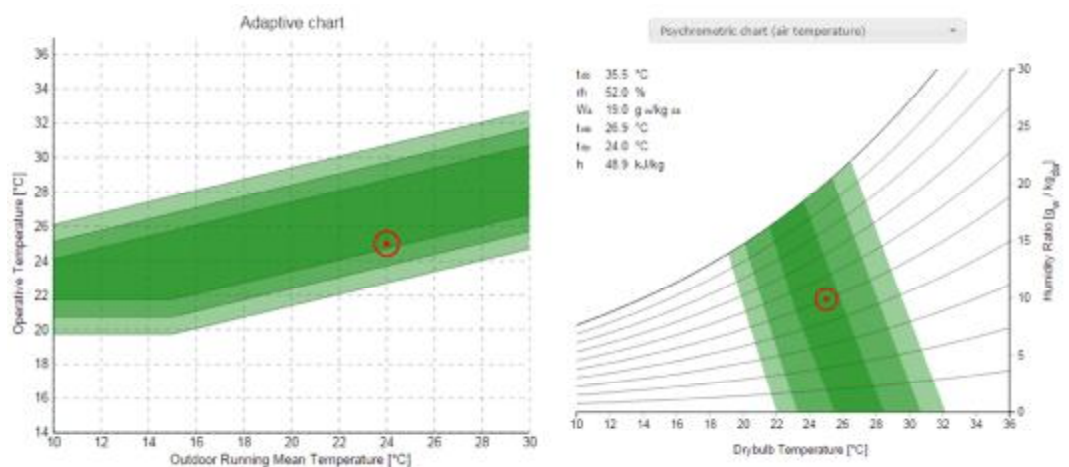

Figure D.7a; D.7b: Graphical evaluation indoor thermal comfort by PPD (left) or by adaptive method (right) according according EN 15251, source : EN 15251 and CBE Thermal Comfort Tool, Center for the Built Environment, University of California Berkeley

Metabolic rates are the variables based on the physical activity of the occupants thus their heating gains and their influence the properties of ideal internal comfort properties of air. Difference You can see in Figure D.6, where are compared two different internal comfort zones of air properties - on the left side is seen the comfort polygon on psychrometric chart more on the left because activity of tenant is set to be higher (active physical work), on the right chart is comfort zone placed more on the right zone because activity of persons occupied the interior is set as easy work . The activities are determined by the known tables where each activity is specified either in W/m^2 or in the unit *met*, where $1 \text{ met} = 58 \text{ W/m}^2$ (356 Btu/hr) and is definition of heat energy from the body production is :

The mean surface area, the Du-Bois area, of the human body is approximately 1.8 m^2 (19.4 ft²). The total metabolic heat for a mean body can be calculated by multiplying with the area. The total heat from a relaxed seated person with mean surface area would be $58 \text{ W/m}^2 \times 1.8 \text{ m}^2 = 104 \text{ W}$ (356 Btu/hr) if the activity will be set for 1 *met*.

=====

O_UC002 Indoor Environment Evaluation

No.	Actor	Activity	Condition
1	User	Login (self define as type of Actor) and decide whether wants to evaluate PPD by tenant feedback or by predictive computation	
2.1.1	User (O)	Opens Voting section start the vote process, set the voting closing time and date (time setting is not compulsory). User may set notifier starting according specific value conditions (to notify if there will be many complaints of tenants)	tenant votes selected
2.1.2	User (U)	Tenants specify their category (tenant company, floor and section occupied = these are not necessary if evaluated space is internal public hall in building), or just select the thermal comfort scale state	tenant votes selected
2.1.3	System	Will opens the voting function and collect the votes till the date and time reaches the selected value and notifies (O) if notifier was preset.	
2.2.1	User (O)	User will specify the monitored sensor data sources and time (from-to; continuously measurement over time) of the physical quantities and set predefined data of (met) and (clo) according mean activity profile and average clothing of the tenants. User will specify the type of computation or regulation according to which shall be PPD evaluated	all required sensors must be installed and functional
2.2.2.	System	System will offer computed results and save them to database of user' s activity. End of Process	
3	User (O)	(Operator will use informations for updating operation of HVAC system.)	

Object User - tenant (U)

Final user of building may be tenant or even owner and is the purpose of building building. His need beside his main business activities is to feel comfortable in building. For this he needs to communicate with operator (sometimes with owner) and inform him about possible issues in technical states of property or internal comfort.

Object User - tenant (U) functionalities

- environment quality rating
 - Internal comfort quality : philosophy of PPD indexes evaluation implementation
- input data for maintenance plan
 - breakdowns notifications
 - satisfaction/dissatisfaction with specific theme

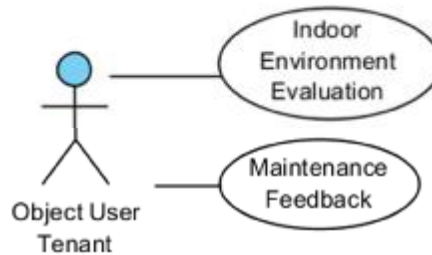

Figure U.10 : Use case diagram for object User (Tenant) as an actor, source : Diaportable graph design

Maintenance Feedback function U_UC001

Use case name : Maintenance Feedback
Use case Identification : U_UC001
Actor : Object User
Restrictions : Actor is not logged in system
Other functions cannot run in main screen (background only);
Actor is not authorised for specific process application

=====

Maintenance feedback function is simple function for providing communication between building operator with building users (mostly tenants). Tenant in the case of need will open the form through his PC and IS account and write specific informations. Function is mostly prepared for informing about any building system or part failures and breakdowns.

Sender of message will thus know, whether his message was read by operator, if there were done some activities solving the issue and when they were done. There will be possibility to upload the pictures also for the possible need to visually describe the problem.

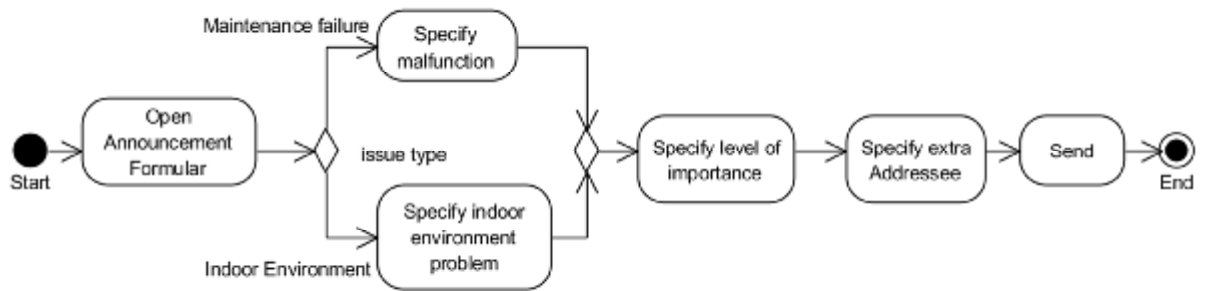

Figure A.15: Activity diagram of Object User (Tenant) role - simple involvement of both functions, Maintenance feedback (Specify malfunction) and Indoor Environment Evaluation (Specify indoor environment problem) in one activity, source: Virtual Paradigm

=====

U_UC001 Maintenance Feedback

No.	Actor	Activity	Condition
1	User	Login (self define as type of Actor) and opens the function	
2	System	System offer the form	
3	User	User will fill up the informations about breakdown (location, type of failure, amount) and forward the form to operator	
4.1	System	System will refuse accept data .	data were not filled completely
4.2	System	System will accept the form, ask for specify the addressee (operator) with his duties. System can determine the type of operator itself according the failure specification and asks for approval.	the amount of operators in building is more than one.
5	User	User will specify or approve addressee	
6	System	Notification sent. End of process.	

Indoor Environment Evaluation function O_UC002

Use case name : Indoor Quality Rating (Indoor Environment Evaluation)
 Use case Identification : N/A (O_UC002)
 Actor : Building User
 Restrictions : Actor is not logged in system
 Other functions cannot run in main screen (background only);
 Actor is not authorised for specific process application

=====

This is definition of Operator’s function O_UC002 from the view of the Building User needs. Tenant will use this function when it will be activated by operator and when tenant will be in need to give feedback of the indoor environment quality.

The page of giving this feedback by voting will have to be known and offered to tenants for use. The voting can be connected with voters by their specification - to locate the potential bad environment in the building or can be anonymised, if the voting place is known and public (public entrance halls, etc.).

Steps to use this function are described in O_UC002 function.



Figure D.6 : Indoor environment thermal states according ANSI/ASHRAE Standard 55-2013, for evaluating PPD by elections, source: Lucidchart design

Voter simply specify his subjective thermal feeling (Figure D.6) and sends the vote to the system by survey confirmation.

Administrator (Ad)

Administrator’s role is crucial for the functionality and reliability of the cloud system as a whole and description of his duties and functionalities for the system may be in the scope of this work pointless, because IT developers will much more specify their needs and functions which is not in the scope of my focus as the concept creator. Functions simply described shall be prepared for the RUP best practice activities - Iterative Development, Active management of the Requirements, Component implementation management, Quality assurance and Testing, Change and Configuration management and Visual Modeling.

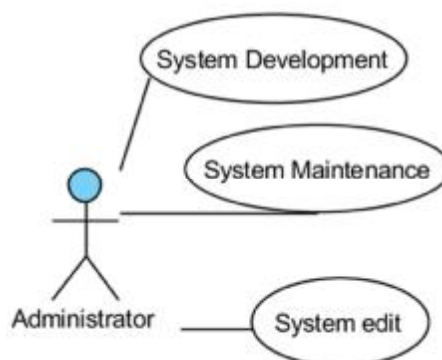
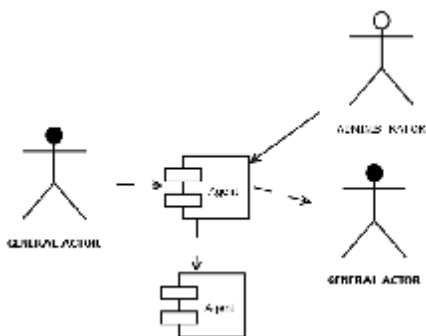

Figure U.11 : Use case diagram for Administrator as an actor, source : Visual Paradigm design

Administrator (Ad) functionalities

- System development
 - development of IS platform layer and user interface layers (thus IS function pages structures)
 - development - programming agent solvers
 - testing
 - development versions management and versions updating, old versions archiving
 - dataflow connection programming from other networks to data storage centers of IS (API)
- whole system maintenance
 - system shutdowns
 - system transmissions to different hardware basement
 - system backups
 - databases
- System editing
 - user profile editing
 - access management: gives / takes specific rights to other actors in their roles
 - userAccess databases access rights/restrictions
 - userIDacce specific userID access rights/restrictions
 - Lock: process access rights/restrictions

Agent solver (Ag)



Agent as a self-active program (or algorithm) cooperating with other agents will be considered also as an individual “actor” even it does not have material form and true intelligence. It is due to main ability to give or take specific solvers access restrictions as well as to monitor their activity on the IS.

Figure U.13 : Relationship description of Solver (Agent) as an actor, source : Diaportable graph design

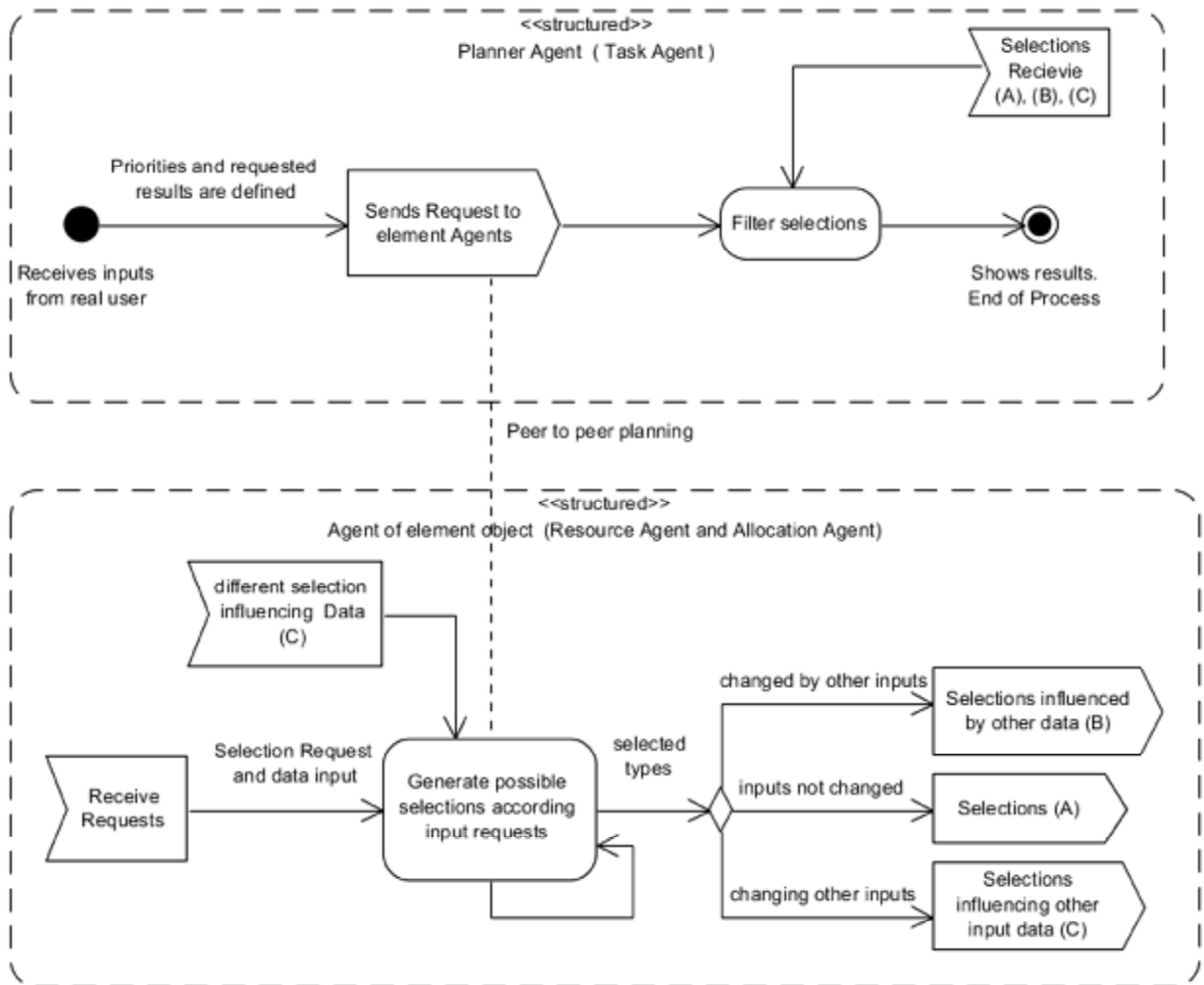

Figure A.19 : Activity diagram of agent solvers, source : Visual Paradigm design

At figure A.19 you can see basic concept of agents activities. User will set specific task in the manner of the Agent's possibilities - he will define requested results and requested priorities from possible and specify also the deviation from the expected results, implicitly or explicitly. *Planner Agent* will receive the the task and its attributes and distribute it *parallely* between the *Element Agents* (mainly between the element agents of selected concept scheme elements, secondary can be distributed to the agents of elements outside the group of selected conceptual scheme) and receives and collects their results. The results may be of three different kind, which are results right according the requested priorities and requested values. Although these requested priorities and values are exactly defined, they will be considered to be requested data for the system as a whole, not requested attributes of specific products. That means, the different elements together may fit the requests even separately some of them may not provide specific requested attribute. Because of this fact the *Element Agents* will provide the results which may influence and change other *Element Agents* thus their selection results. The state of *affecting / being affected* will be commonly used for find the best alternative available by this iteration process. Not only products but also specific phenomenon such for example liquid flow can be considered *Element Agent* to whom may be distributed specific tasks (for example selecting ideal fittings).

Due to its crucial importance within gaining to the processes in construction and industrial branches huge potential in the performance growth[11], I consider the implementation of the agents to the IS functionality as necessary. Agents process the predefined tasks which distributes between each other and during their peer to peer communication specific solutions in compliance with requests are found. One potential they give to the design systems other potential dimensions exist in real-time decisions made for operating specific installed systems in reality. Both is possible and depends on each other.

One from the known strategies used for problems solving has been analyzed by Durfee [11], called *task-sharing* approach. It's principle is based of passing tasks from the busy agent to a vacant agents. This process can be recognised in four basic steps.

- 1/ *Task decomposition*: Tasks of agents are decomposed into subtasks and sharable tasks are selected.
- 2/ *Task allocation*: Selected tasks are assigned to the vacant agents which asks for them.
- 3/ *Task accomplishment*: Each agent tries accomplish its tasks and subtasks. Tasks which needs further decomposition are recursively processed and then passed to the other agents.
- 4/ *Result synthesis*: Results of the tasks are returned to the allocating agent, since it is aware how to use it in the context of the higher tasks.

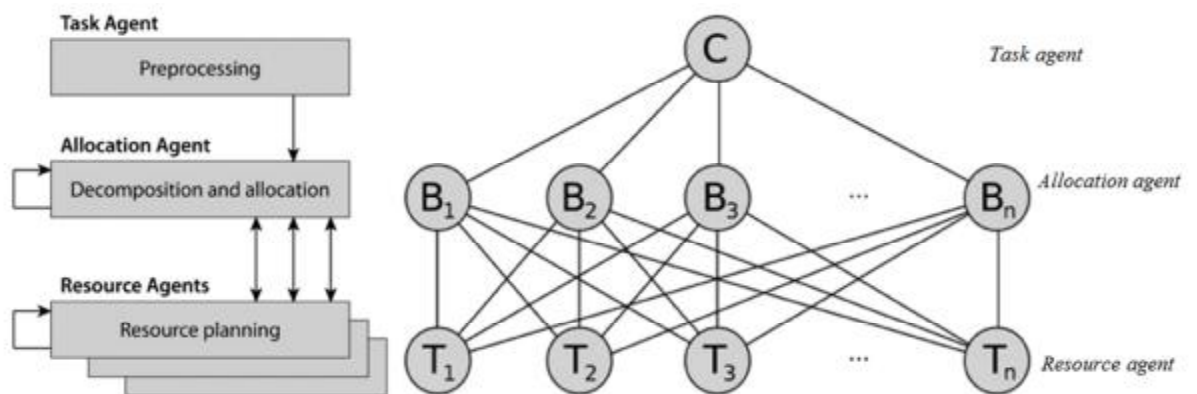

Figure G.16 and G.17: Abstract architecture of agent-based solver-planner (left) and their hierarchy (right), source : [10]

According the [10] can three types of agents be defined in the abstract multiagent solver architecture:

- 1/ *Task agent* : which is agent for preprocessing of the problem.
- 2/ *Allocation agent* : this agent decomposes the problem to separate tasks and delegate it to the resource agents. It also absorb the results and make their synthesis.
- 3/ *Resource agent*: This agent is for individual case-specific resource planning.Task agent.

This systems is from one Task Agent, one Allocation agent and set of resource agents. In Figure A.19 I joined Task Agent and Allocation Agent activities into one type

of agent which undertakes both roles of the agents. Multiagent solver uses principles of the decomposition of the problem and its delegation to other autonomous agents. After receiving the solved partial results from the task agents, they are merged together to create complete solution. The logic of algorithm architecture of multiagent architecture is based on Smith's contract net protocol (CNP) [35] and its abstract objective function and algorithm improvement strategies are defined in [10]. CNP interactions in cooperative environment is commonly described as *utilitarian social welfare maximalization* as an economic term [29] [36].

One of the problems can be that data (technical and price data) for these solver actions needs to be publically shared which can be considered by many data providers (manufacturers) as their commercial competitive disadvantage. Frankly, even worse disadvantage would be, if they would stay off their sales potential.

Agent (Ag) functionalities

- processTask : Processing programmed tasks
- allocateTask : Decomposing and allocating task
- mergeTaskResult: Merging results of decomposed task's results
- selfCopy : self-replication
- selfDelete : self-deleting
- dataExchange : data exchange with another agents of same and different types
- dataImport: import data for processing task
- dataExport : Export data

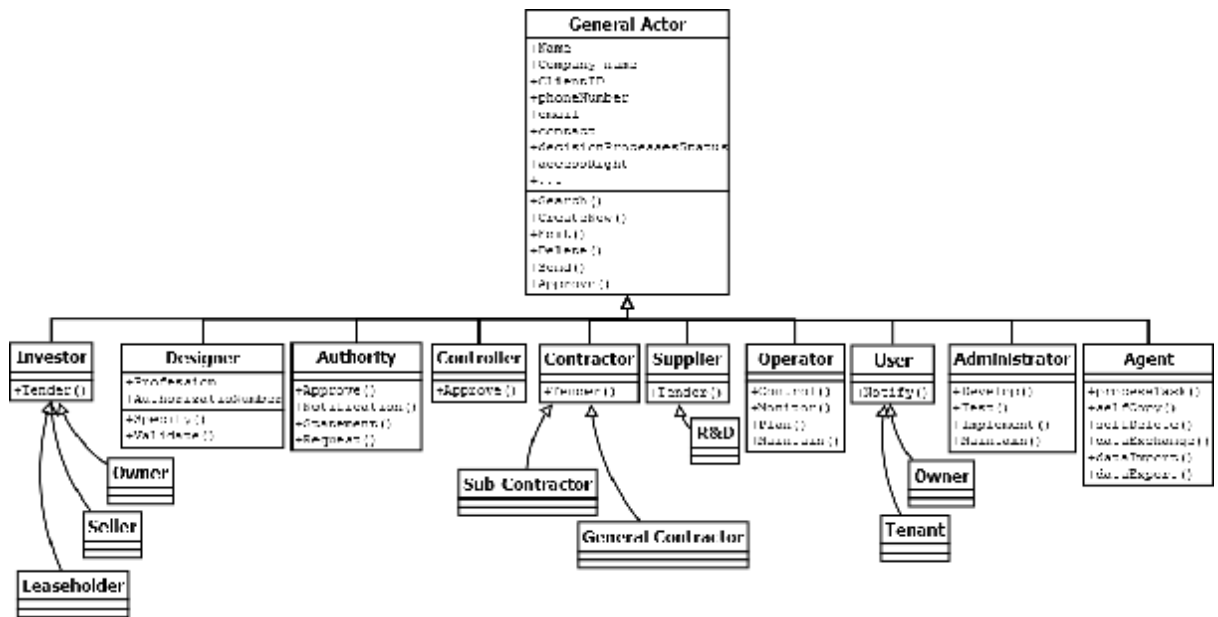

Figure C.1 : Class diagram of structuring the actor roles with their basic differences in functionalities, source : Diaportable graph design

Requirements for system

- Hardware :
 - system(service) supply : server with computing capacity and data-storage space according specifications mentioned in this work (not specified yet - not important at this level of design)
 - system(service) demand : client : laptop, tablet, desktop computer, smartphone
- Software :
 - server : operating system compatible for Java Platform (JDK ver. 5.8.0) (Windows Server, Linux)
 - client : any operating system spreaded mostly at the market : Windows 7, Windows Vista, Windows 8, Windows 10, Mac OS X

Project's potential : Business plan

Project's potential in the Construction market due to its necessity to continuously develop the country's face is wide. Today, matters whether the development can be distinguished as *sustainable* by the society, and Cloud application described in this work has potential to grow and settle the new position where can be implemented human technical, law and financial knowledge with machine learning, understanding and data processing.

There are more separate areas which are described in the IS as a whole and each of them could be specific business plan. If We talk about Business plan, my first priority during thinking about the system is non profitable project, where most of the functions would be not used for the private enterprise and profit, especially the later integration of spatial planning supporting applications and finances fundraising will have effect for better understanding the decision processes of sustainable urbanisation. Commercial value can be added to many specific parts especially for actors as manufacturer, contractor, designer and investor.

Many of now running cloud applications are successful for their fulfilment of gap on the market : ebay, paypal, google search engine, each with different focus and each with huge turnover and outcome nowadays. Business plan shall be based obtaining revenues not by raising the margin but by increasing the turnover of the offered payed services.

When there will be tool to helping Investor to find capital for specific project in the range of the IS, demand for the system usage will grow.

Involve the lay society

Project may offer also social dimension when it connects Authority, finances and Lay society together to real-time environment where can be communication and fast data evaluation visible in a moment. Lay society, no matter, how subjective or non-correct opinion has, is opinion creator and creates wide range of political decisions, fortunately. Why it should not be more involved in the spatial and urban planning in real time ?

Social profit for governments

In the compliance with paragraph above, free access to most of functionalities for the governments world-wide can improve not only the administration processes which are necessary for the construction industry but for consensus with the society in the matter of development decisions made on the situation, where all sides reach the state, when they will not reach their own best maximum utility without the help of the other sides. Which is the the process leading to the Nash's equilibrium state known and

discussed in the theory of games and economic behaviour [15] of commercial and political subjects.

Conclusion and Outlook

In my work I described the reasons of my efforts and motivation together with description of my view about the situation in construction industry and its connection with economy and the term of sustainable and unsustainable development. Description of the Mondis application and survey was preceding the practical part.

In practical part I specified general priorities and requirements of the designed system and focused to determination the actors, their roles, relations between them and their most important use cases. For this work I used UML diagrams and where the matter was not possible to describe, I used BPMN diagrams for activities description.

In survey results I found predicted problems in the work efficiency of Designers and as this is my closest branch, I tried to focus to the description of the Designer's role hand in hand with General Actor's role at the most.

During writing description I found out, that mapping of the construction projects participant's activities are more complex that I assumed in the time before I began to write this thesis. Construction industry is strongly connected with manufacture industry, which needs and demand needs to be considered in the future cloud application for improving the efficiency of the all participants cooperation.

Their complete description overlaps scope of my work and should be extended and described in more detail. Functions G_UC006 Embedded Applications and Agent solver functions, D_UC003 Concept Analysis, Au_UC003 Multi-scale Planning, SM_UC002 Market Analysis, I_UC001 Business Plan Programming, I_UC002 Budget management, I_UC003 Clients Management are functions which I had time to only mention generally with their general description as well as basic description of the roles Investor (I), Agent (Ag), Administrator (Ad). On the other side, functions for technical roles such as Designer (D), Operator (O), and Authority (A) are described with higher complexity.

Due to my education and different professional focus I had troubles to fastly absorb unified programming language and BPMN rules as well as other conceptual understanding of the programming principles for whose I need much more time and effort. Beside this fact I can agree with all my hypotheses (short-term) which I set in at the beginning of work.

- I. Concept of cloud application can describe of all existing processes which are crucial for the improvement of efficiency
- II. Concept does describe potentially problem-solver functionalities. "Bad aspects" has been determined by my conclusion based on my work experience as well as by the survey in the paragraph *Specification of the troubles* : troublemakers . Bad aspects which have been determined, are ineffective search for informations, ineffective

- computational design and his control, ineffective communication between participants of the building process.
- III. I found out, that third hypothesis is long-term , thus I cannot to confirm or confute it.

Potential for the future

Fusion of all construction industry and manufacture industry needs to one complex integrated informational point is according my opinion the demand of future processes evolution and is going forward it even without my effort. In Addition the system can brings value to the economy and human influence to environment research. Concept presented in this work has chance to be used for further planning and realisation. Mentioned neglected functions and roles in the conclusion above is showing necessity to further develop the aspects, aims and methods of possible applications preparation. There is good potential to develop the text databases concept for the *search*, *compare* and *approval* processes with their framework and methodology of definition of the ontology relations of the text informations, develop the evolution evolution possibilities implementation of the ontology for the IFC objects.

There is high potential also to develop possible connections and ways of information exchange of the technical based functions, informations and systems with money markets and use it potential for the construction industry grow.

To mention further potential, in the time, when the IS would be operational, it gains ability to absorb data for spatial planning, which will give to developer a potential to grow its abilities to help making decisions effective for the society as a whole in sustainable development on the macroeconomy level by giving the user the machine selecting the best possible existing alternative.

Spatial planners investors and building designers may thus say that they chose the best possible available and existing alternative ever ... with high percentage of probability of course.

Reference literature:

note: reference naming is slightly different from the thesis assignment references

- [1] Smith, A.: *Wealth of Nations, Book V*. Chapter 5. 1776.
- [2] Charles M. Becker, Terry-Ann Craigie. *W. Arthur Lewis in Retrospect*. In: *The Review of Black Political Economy*, Volume 34, Issue 3, pp 187-216, 2007.
- [3] W. A. Lewis. *Economic Development with Unlimited Supplies of Labor*. The Manchester School Vol. 22 - 1954 - pp. 139-191, 1954.
- [4] Osborne, M. *An introduction to game theory*. Oxford: Oxford University, 2004. ISBN 978-0-19-512895-6.
- [5] Frick, D. *Theorie des stadtebaus* (2nd. ed). Berlin: Ernst Wasmuth Verlag, 2008. ISBN-10: 3803006546.
- [6] Flamm, I. *Multi-Scale Planning Using the MUP-City Software – The Klosterneuburg Case* -. Besançon: UFR SMP, 2013. Master thesis. Universités de Franche-Comté et de Bourgogne, submitted at Vienna University of Technology, Faculty of Architecture and Planning
- [7] PIGOU, A. *The economics of welfare*. 4th edition. London: Macmillan & Co., 1932, 837 s.
- [8] Lomborg, B. *Human Welfare, Part II.*, Cambridge:Cambridge University Press, 2001. ISBN 0-521-01068-3.
- [9] Boardman, N. E., *Cost-benefit Analysis: Concepts and Practice*. (3rd ed.). Upper Saddle River, NJ: Prentice Hall,2006. ISBN 0-13-143583-3.
- [10] J.Vokřínek, A.Komenda, M.Pěchouček. *Abstract Architecture for Task-oriented Multi-agent Problem Solving*. IEEE Transactions on Systems, Man, and Cybernetics, Part C: Applications and Reviews, IEEE Transactions on (Volume:41 , Issue: 1), p. 31 -40, Prague: CTU, 2011. ISSN 1094-6977.
- [11] E. H. Durfee. *Distributed problem solving and planning, in A Modern Approach to Distributed Artificial Intelligence*. G. Weiß, Ed. San Francisco. CA: The MIT Press, 1999, ch. 3.
- [12] WURZEL, P. *Drilling Boreholes for Handpumps*. (= Working Papers on Water Supply and Environmental Sanitation, 2). St. Gallen: Swiss Centre for Development Cooperation in Technology and Management (SKAT),2001.
- [13] Řepa, V.: *Analýza a návrh informačních systémů*. Ekopress, Praha 1999, ISBN: 80-86119-13-0. str. 17-19.
- [14] P. Julinek. *Použití RUP pro malé SW projekty*. Brno:MU,2008. Diplomová práce. Masarykova univerzita, Fakulta informatiky.

- [15] Copeland, A. H. *Review: Theory of Games and Economic Behavior by John von Neumann and Oskar Morgenstern*. Princeton:Princeton University Press, 1944. ISBN 978-0691130613.
- [16] Kanisová, H., Müller M.: UML srozumitelně, 2. aktualizované vydání. Computer Press, a.s., Holandská 8, Brno, 2007. ISBN 80-251-1083-4.
- [17] Arlow, J., Neudstadt I.: UML 2 a unifikovaný proces vývoje aplikací, 1. vydání. Computer Press, a.s., Holandská 8, Brno, 2008. ISBN 978-80-251-1503-9.
- [18] *IFC2x4 Specification Methodology*. [online] buildingSMART International Ltd. (© buildingSMART 1996-2015). [2.1.2016]. Available from : <http://www.buildingsmart-tech.org/ifc/IFC2x4/>
- [19] Křemen, P. – Blaško M. - Šmíd, M. - Kouba, Z. - Ledvinka, M. - et al.: *MONDIS: Using Ontologies for Monument Damage Descriptions*. In Znalosti 2014. Praha: VŠE, 2014, p. 66-69. ISBN 978-80-245-2054-4.
- [20] M.Blaško. Template-Based Ontology Evolution. Praha: ČVUT, 2015. Doctoral thesis. Czech Technical University in Prague Faculty of Electrical Engineering Department of Cybernetics.
- [21] Ghinwa Jalloul. *UML by Example*, p.26, Cambridge: Cambridge University Press 2004. ISBN 9780521810517.
- [22] Abrušová,P. *Inovatívne technológie v pamiatkovej obnove priemyselných budov. Nové využitie objektov textilného priemyslu : dizertačná práca*. bratislava : Fakulta architektúry stu, 2013. 187 s.
- [23] Mlynka,L. Technické pamiatky – vymedzenie pojmu. in: Gregorová, J. - Gregor, p. (ed.): *Prezentácia architektonického dedičstva II*. bratislava : perfekt, 2008. ISBN 978-80-8046-394-6.
- [24] Aundhe, M.D., and Mathew, S.K., Risks in offshore IT outsourcing: A service provider perspective, *European Management Journal* (2009), doi:10.1016/j.emj.2009.01.004
- [25] WIEGERS, K.E.: *Požadavky na software: od zadání k architektuře aplikace*. 1. vyd. Brno 2008, ISBN: 978-80-251-1877-1
- [26] BRUCKNER, Tomáš; VOŘÍŠEK, Jiří. *Outsourcing a jeho aplikace při řízení informačních systémů podniku*. 1. Vyd. Praha: Ekopress, 1998. 119 str. ISBN: 8086119076
- [27] FANGER, P. *Thermal Comfort: Analysis and Applications in Environmental Engineering*. Copenhagen: Danish Technical Press, 1970, 244 s.

[28] *Thermal Environmental Conditions for Human Occupancy*. [payed access online] ANSI/ASHRAE Standard 55-2013.(2013). Available from: <https://www.ashrae.org/resources--publications/bookstore/standard-55>

[29] Shephard, Wade . *Ghost Cities of China: The Story of Cities without People in the World's Most Populated Country*. London: Zed Books, 2015. ISBN: 9781783602186.

[30] Carl S. Chatfield, Timothy D. Johnson. *Microsoft Office Project 2003 Step by Step*,2003. ISBN-13: 978-0735619555

[31] Svozilová, A.: *Projektový management*, 1. vydání. Nakladatelství GRADA, 2006, 353s. ISBN 80-247-1501-5.

[32]Yang, C. and Huang, J.-B.: A decision model for IS outsourcing, *International Journal of Information Management*, 2000, Vol. 20 No. 3, pp. 225-39

[33] Molnár, Z. *Podnikové informační systémy*. 2. vydání. Česká technika - nakladatelství ČVUT, 2009. Praha, 195s. ISBN 978-80-01-04380-6.

[34] SCHOLLEOVÁ, Hana. *Ekonomické a finanční řízení pro neekonomy*. 1. vyd. Praha: Grada, 2008, 256 s. Expert (Grada). ISBN 978-80-247-2424-9.

[35] R. G. Smith. *The contract net protocol: High level communication and control in a distributed problem solver*. *IEEE Trans. Comput.*, vol. C-29, no. 12, pp. 1104–1113, Dec. 1980.

[36] ARROW, Kenneth Joseph (ed.), Amartya Kumar SEN (ed.) a Kōtarō SUZUMURA (ed.). *Handbook of social choice and welfare*. 1st ed. Amsterdam: Elsevier, 2002, xix, 633, 23 s. Handbooks in economics, 19. ISBN 0-444-82914-8.

Images list

Figure G3+4 :Iron triangle of management , source: [30]
Figure G.9 :Impact of Evaluation of project on the sustainability, source: Diaportable design
Figure 3: Average percentage values of the time consuming by specific work processes structured by the main roles, source: terrain survey evaluation results
Figure 4: Average point values (according legend) of the effort caused by difficulties during specific work processes structured by the main roles, source: terrain survey evaluation results
Figure RP.10 :Rich Picture of conceptual impact relations , source : Visual Paradigm design
Figure A.1: Project life cycle phases and its activities description. Readable diagram in large format is listed between attachments on the end of work. Source: Bizagi modeller design
Figure MC.1 : Class diagram of the characteristic roles within Construction process according the content their duties, source: Diaportable design
Figure MC.2 :Multiple Classification diagram of Building object distinction
Figure MC.3 :Multiple Classification diagram of Building parts objects distinction
Figure G.7: Impact to prioritize Sustainable Development pillars according it also Project Design, source : Diagram designer scheme design

Figure RP.11 : Impact of assets transformation to project, source : Visual Paradigm design
Figure RP.12 : Rich picture of scheme of main factors - different types costs and revenues considered by private investor payed investment by his capital or with cofinance of foreign capital. Is the investment profitable ? How can we know ? source : Diaportable graph design
Figure G.13 : Difference between Profit interest evaluation and public interest evaluation, source : Diaportable graph design
Figure 5: A large machine-mounted rig for drilling, in Sub-Saharan Africa can cost from US\$ 2,000 to US\$20,000 Source: [12]
Figure ER.7 :Entity Relationship diagram of application of automated solution solvers (embedded functions), source : Diaportable graph design
Figure RP.8 : Rich Picture - simple description of influence of one profession's design change to others. This shows the necessity to resolve possible relations and influences of different elements which could create bigger groups- systems. Source : Diaportable graph design
Figure G.2 :Construction Design transformation to BIM, source : Diagram designer scheme design
Figure 18: Class diagram of objects (flow elements) in relative (abstract) in the left and in explicit selection with distribution control element on the right, source: [18]
Figure 19: Class diagram of the root class structure of IFC entity definitions, source:[18]
Figure G.7 phases and structure of Information System development, source : [14], [21]
Figure G.5 : Basic notation of process, source : Diaportable graph design
Figure G.14: used packaged information characteristic, source : Diaportable graph design
Figure G.15 : basic IS concept description, source : Diaportable graph design
Figure ER.0a : Conceptual scheme of grouped specific product object templates into specific design concept template. This scheme contains same structure of objects in Figures ER.0b, ER.0c but on the more simple layout without shownd data in the class model. Product (default) objects shows data attribute on the most simple level. Source Diaportable graph design
Figure ER.0b :Class diagram of basic data classes of the specific part of the conceptual scheme of cooling system. Water piping describes all the connections between other elements. Product (default) objects shows data attribute on the basic level. Source Diaportable graph design
Figure ER.0: Class diagram of basic data classes of the specific part of the conceptual scheme of cooling system. Product (default) objects shows data attribute on the more detail level. source : Diaportable graph design
Figure S.1: Description of never-ending building (parts) revision process and its possible impacts to other professions. Gray data are measured project data change which is interesting Investor considerations and decisions, from two specified, Costs are more important , source : Diaportable graph design
Figure G.1 :User (actor) specification : 1st. level, source : Diaportable graph design
Figure C.1d : Entity Relationship diagram of main roles in the building process and their possible interactions, source : Diaportable graph design
Figure U.1 and U.1.b: Use case diagram for general actor, source : Diaportable graph design
Figure ER.0b:Entity Relationship diagram for general actor, source : Diaportable graph design
Figure C.1b : Class Diagram with basic descriptions of the actor and his functions as the structure of data flow. Each object, whether actor or his activity has specific data Attributes which needs to be stored in database to record activity and their results for big data evaluations, source : Diaportable graph design
Figure A.2: Activity diagram of appovement procedure (General), without and with decision possibility by voting within working group. Aprovement procedure is more specified for the Authority utilization in Authority roles and functions -Au_UC001- Administration Approval Process, which is slightly more extended. Source : Diaportable graph design
Figure D.0 : Basic division of data library classes and their usage between different Actor roles in process.

Databases are now market as X which is actually meant as “high usage” but over time You can simply see statistical data in numbers as result of Big Data analysis procedure
Figure D.1 : examples of a Graphical results from function search, searching climatic data, possible package template for more of such specified climate data, source: Ecotect Analysis, Weather Tool, 2011 Autodesk
Figure D.2 :possible package template for more of such specified climate data, source: Ecotect Analysis, Weather Tool, 2011 Autodesk
Figure D.3 : Cumulative times of outside temperature graph. Source : own excel design
Figure D.4 : Condensing Boiler efficiency graph. Two efficiency curves according two different temperature gradient sets. Source : own excel design
Figure SD.3 : State diagram of project evolution and its connection to search and compare functions throughout design phases, source : Diaportable graph design
Figure SD.3b : State diagram of project evolution and its connection to search and compare functions throughout design phases, source : Diaportable graph design
Figure C.01 : Class diagram example of Text data object class structure for the search function, source : Diaportable graph design
Figure WF.01 : Wireframe example of the Search Function, Source : Wireframe Sketcher Studio own design, graphical data from Weather Tool 2011, Ecotect Analysis 2011 software
Figure D.8: Example of climatic data graphical export to Psychrometric air properties chart (black crosses marks hourly year temperature DBT) with another data types - recommended (or set) air property zones for using specific HVAC processes according figure : passive solar heating, thermal mass effects potential, exposed mass + night ventilation, natural ventilation, direct evaporative cooling, indirect evaporative cooling . Each of these processes can be implemented during design process and data provided can be good tool and documentation for supporting the design process. Source : Ecotect Analysis, Weather Tool, 2011 Autodesk
Figure A.5 : Activity diagrams of Communication function, source : Diaportable graph design, right diagram : [21]
Figure I.01: Example of compare function for Investor demand, source : Diaportable graph design
Figure C.8 - Class diagram of Tag object, source : Diaportable graph design
Figure U.01d: Use case diagram for Tag function, source : Diaportable graph design
Figure WF.02: Wireframe example of Tag. Tagged information is some heating systems BAT prices lower by 5% in the last month. We do not know more, which of BAT systems and on which market it is specified. Tagger did not tag information about place and type of BAT, which will be necessary to investigate by source information. Source Wireframesketcher Studio design
Figure A.10: Activity diagrams of creating and reading the Tags. Source: Diaportable design
Figure S.2 : State diagram of the building project phases with description the occasion of tendering, and state diagram of main Tender states for valid for all Actors involved in the process : investor (or owner), designer, contractor, subcontractors and suppliers. source : Diaportable graph design
Figure S.2b : BPMN Choreography diagram describing the building project phases with description the occasion of tendering, needed by contractor, subcontractors and investor/owner. It is important to mention that border between planning and construction phase is not exactly clear and tenders for construction may take place during planning phase as well, in specific circumstances vice-versa state also is possible. In the lower diagram is simplified process of application to any mentioned tender by applicant. Source : Lucidchart design
Figure A.12: Activity diagram of initiation and setting the Monitor function, source: Visual Paradigm design
Figure ER.11: Entity relationships diagram of the Tender process, explaining the participants and their relations, source : Lucidchart design
Figure A.13: Activity diagram of basic sub-functions in Tender G_UC010 function, source: Visual Paradigm
Figure A.8 : Activity Diagram of Tender Proposal Preparation process logic. It is important to mention that this activity can be repeated within tender several times between one Tender announcer and more Tender Competitors for obtaining the best competitive price for best competitive performance in the philosophy of

moving closest to the economic theorem perfect competition market , source : Visual paradigm design
Figure U.2 : Use case diagram for Investor as an actor, source : Visual Paradigm design
Figure ER.1 : Entity relationship diagram of Investor as an actor and his main relations with the processes and other participants, source : Diaportable graph design
Figure ER.9: Description of the Design circle with most occurred places of going backwards in the process. Process needs to give valid credible results, doing credible results eats time. Time is money. Source: Diaportable design
Figure U.3 : Use case diagram for Designer as an actor, source : Visual Paradigm design
Figure ER.2 : Entity Relationship diagram of Designer as an actor divided into General and Profession designers in communication with Investor, source : Diaportable graph design
Figure A.7 : Activity diagram of Designer's most important activities within the IS, with subprocess of concept elements specification, source : LucidChart designer
Figure C.9 : Example of an Attribute Class with its own attributes and operations.
Figure ER.10: Entity Relations diagram with description of activities of designer as a whole, assume that entity "designer" is joined with all relations in the rhombus. Source: Diaportable design
Figure WF.03: Wireframe example of the Design page (Specification elements design phase), source: Wireframe Sketcher Studio design
Figure U.4 : Use case diagram for an Authority official as an actor, source : Diaportable graph design
Figure ER.3: Entity Relationship diagram of Authority official roles as an actor in IS thus in building process, source : Diaportable graph design
Figure C.4 : Class diagram with structure for data storage of the Approval process for an Authority official as an actor, source : Diaportable graph design
Figure A.3 : Activity diagram focusing administration approval process of Authority more deeper, source : Diaportable graph design
Figure A.6b : BPMN diagram of administrative process direction for an Authority official as an actor. Diagram is answering questions about who initiates the process and who will be asked to participation within internal administrative sub-processes part. Source : Visual Paradigm design
Figure A.18: Activity diagram of the Another Institution Request function, source : Visual Paradigm design
Figure U.5 : Use case diagram for Contractor as an actor. These functions describes main needs of contractor but all of them are specified within General Actor role source : Diaportable graph design
Figure ER.4 : Entity Relationship diagram for Contractor as an actor, source : Diaportable graph design
Figure C.5 : Class diagram with specified functionalities for Contractor as an actor, source : Diaportable graph design
Figure U.6 : Use case diagram for technology or material Supplier as an actor, source : Diaportable graph design
Figure ER.5: Entity Relationship diagram for technology or material Supplier as an actor, source : Diaportable graph design
Figure A.14: Activity diagram of the Product Data management activity flow, source: Visual Paradigm
Figure U.7 : Use case diagram for Operator as an actor, source : Diaportable graph design
Figure ER.6 : Entity Relationship diagram for Operator as an actor, source : Diaportable graph design
Figure A.17: Activity diagram of Operators main functions. This process is consisting from receiving information from the Object user Tenant (U) with U_UC001 function and with receiving informations either from BAS systems or from separate sensors where can be used Monitor processes function G_UC009.
Figure D.5: PPD - Predicted Percentage of Dissatisfied persons index computed within excel module, Source: ASHRAE thermal sensation scale, ANSI/ASHRAE Standard 55-2013, Thermal Environmental Conditions for

Human Occupancy, [27], [28]
Figure A.16: Activity diagram of “Specify Indoor Environment Problem” part of Object User’s activity is Operator’s activity (PPD evaluation), source : Visual Paradigm design
Figure D.6: Influence of the metabolic activity of tenants on the required indoor environment properties of air, source : Ecotect Analysis, Weather Tool, 2011 Autodesk
Figure D.7a; D.7b: Graphical evaluation indoor thermal comfort by PPD (left) or by adaptive method (right) according according EN 15251, source : EN 15251 and CBE Thermal Comfort Tool, Center for the Built Environment, University of California Berkeley
Figure U.10 : Use case diagram for object User (Tenant) as an actor, source : Diaportable graph design
Figure A.15: Activity diagram of Object User (Tenant) role - simple involvement of both functions, Maintenance feedback (Specify malfunction) and Indoor Environment Evaluation (Specify indoor environment problem) in one activity, source: Virtual Paradigm
Figure D.6 : Indoor environment thermal states according ANSI/ASHRAE Standard 55-2013, for evaluating PPD by elections, source: Lucidchart design
Figure U.11 : Use case diagram for Administrator as an actor, source : Visual Paradigm design
Figure U.13 : Relationship description of Solver (Agent) as an actor, source : Diaportable graph design
Figure A.19 : Activity diagram of agent solvers, source : Visual Paradigm design
Figure G.16 and G.17: Abstract architecture of agent-based solver-planner (left) and their hierarchy (right), source : [10]
Figure C.1 : Class diagram of structuring the actor roles with their basic differences in functionalities, source : Diaportable graph design

Tables

General Actor	G_UC000	Approval Process
	G_UC001	Search for information
	G_UC002	Communication
	G_UC003	Compare
	G_UC004	Tag Information
	G_UC005	Vote (Elections function)
	G_UC006	Embedded Applications and Agent solver functions
	G_UC007	Manage Data
	G_UC008	Data Import/Export
	G_UC009	Monitor Processes
Designer	D_UC000	Tender
	D_UC000	Search Libraries
	D_UC001	Conceptual Design
	D_UC002	Specify Design Criteria
Authority	D_UC003	Concept Analysis
	Au_UC000	Technical and legal regulations management
	Au_UC001	Administration Approval Process
	Au_UC002	Another Institution Request
Supplier	Au_UC003	Multi-scale Planning
	SM_UC001	Product Data Management
Investor	SM_UC002	Market Analysis
	I_UC001	Business Plan Programming
	I_UC002	Budget management
Operator	I_UC003	Clients Management
	O_UC001	Maintenance Data Management
Object User	O_UC002	Indoor Environment Evaluation
	U_UC001	Maintenance Feedback

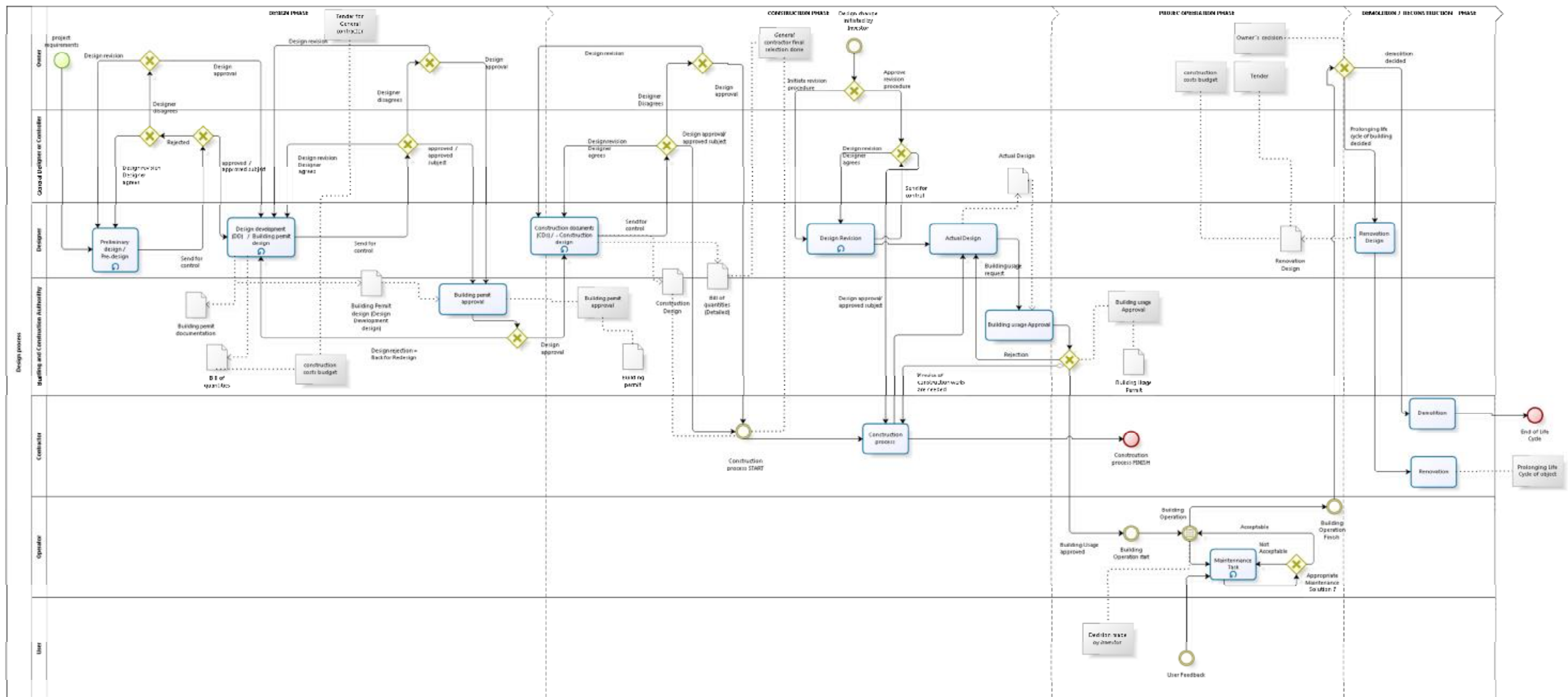

Figure A.1 : Process diagram of Project life cycle and relations of the role's product on the other roles. Project Design, Construction, Operation, and Demolition process phases are in vertical direction, project participants in horizontal pools.
 Source: Bizagi modeller design