

## Technical Data for Profiles

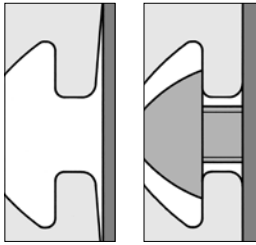

### Extruded Profile

Symbol Al Mg Si 0.5 F 25  
 Material number 3.3206.72  
 Status: artificially aged

### Mechanical values (apply only in pressing direction)

Tensile strength  $R_m$  min. 245 N/mm<sup>2</sup>  
 Yield point  $R_{p0.2}$  min. 195 N/mm<sup>2</sup>  
 Density 2.7 kg/dm<sup>3</sup>  
 Ductile yield  $A_5$  min. 10 %  
 Ductile yield  $A_{10}$  min. 8 %  
 Linear coefficient of expansion 23.6x10<sup>-6</sup> 1/K  
 Modulus of elasticity  $E$  approx. 70,000 N/mm<sup>2</sup>  
 Modulus of rigidity  $G$  approx. 25,000 N/mm<sup>2</sup>  
 Hardness approx. 75 HB - 2.5/187.5

### Tolerances

Deformations such as straightness and flatness tolerance to DIN EN 12020 Part 2.

Profiles not cut to size may be up to 100 mm longer than specified, due to manufacturing methods.

### Surface

The aluminium profiles are natural (C0) or black (C35) anodized and are therefore permanently resistant to scratching and corrosion. Surface with matt finish (E 6), compressed with anodic oxidation. Minimum layer thickness 10 µm, layer hardness 250 - 350 HV. The all-round hard anodized surface covering makes saw cuts virtually burr-free, thereby eliminating the need for remachining.

All standard Profiles and Profiles "light" and Profiles "E" feature defined points of support on the Profile exterior and inclined groove flanks. These ensure a firm and stable connection with other components. Thanks to controlled elastic deformation in the groove flanks, the fastening screw creates a vibration-free connection.

## Groove position, external dimensions and modular dimensions

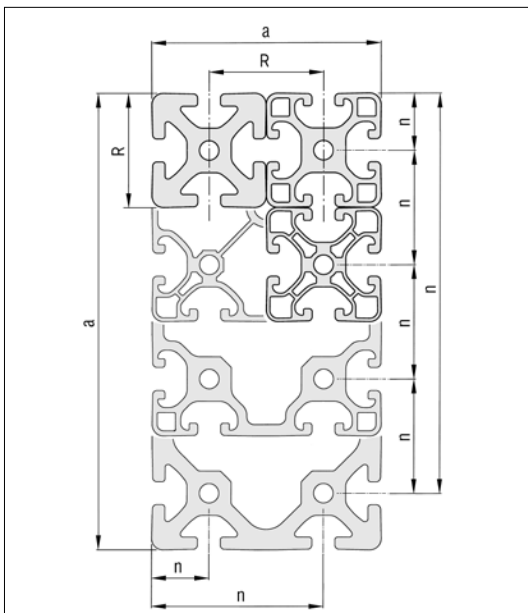

Modular dimension R [mm]				
5	6	8	10	12
20	30	40	50	60

Profile edge length a [mm]		Tolerances of external dimensions a and groove position n ± [mm]
from	up to	
0	10	0.10
10	20	0.15
20	40	0.20
40	60	0.30
60	80	0.40
80	100	0.45
100	120	0.50
120	160	0.60
160	240	0.80
240	320	1.50

## Groove Dimensions

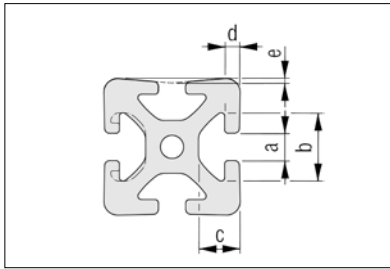

	5	6	8	10	12
a	5.0 <sup>+0.3</sup>	6.2 <sup>+0.3</sup>	8.0 <sup>+0.4</sup>	10.0 <sup>+0.4</sup>	12.0 <sup>+0.4</sup>
b	11.5 <sup>+0.3</sup>	16.3 <sup>+0.3</sup>	20.0 <sup>+0.4</sup>	25.0 <sup>+0.4</sup>	30.0 <sup>+0.3</sup>
c	6.35 <sup>±0.15</sup>	9.75 <sup>+0.2</sup>	12.25 <sup>+0.3</sup>	15.5 <sup>+0.3</sup>	18.3 <sup>+0.3</sup>
d	1.8 <sup>±0.1</sup>	3.0 <sub>0.25</sub>	4.5 <sup>+0.3</sup>	5.3 <sup>+0.3</sup>	6.6 <sup>+0.3</sup>
e	0.15 <sup>±0.1</sup>	0.15 <sup>±0.1</sup>	0.2 <sup>±0.1</sup>	0.25 <sup>±0.1</sup>	0.3 <sup>±0.1</sup>

## Core Bores

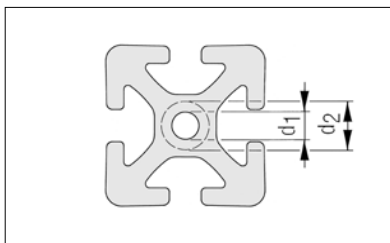

	5	6	8	10	12
Drilled hole d <sub>1</sub>	∅ 4.3 <sup>+0.1</sup> mm for M5	∅ 5 <sup>+0.2</sup> mm for M6	∅ 6.8 <sub>0.2</sub> mm for M8	∅ 8.5 <sub>0.2</sub> <sup>+0.1</sup> mm for M10	∅ 10.2 <sub>0.2</sub> mm for M12
Reborable up to d <sub>2</sub>	∅ 6 mm or M6	∅ 8 mm or M8	∅ 13 mm or M12 (not Profile E)	∅ 16 mm or M16 (not Profile E)	∅ 20 mm or M20

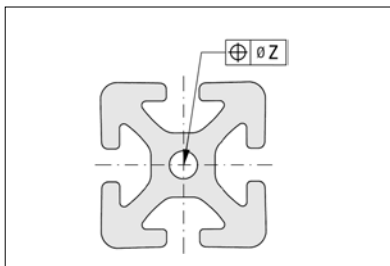

Profiles with Open Grooves		Closed Grooves	
Number of Holes	z [mm]	Number of Holes	z [mm]
1	0.4	1	0.6
2 to 4	0.6	> 1	0.8
> 4	0.8		

The hole position tolerance depends on the number of core bores and the profile contour.

## Tensile Loading

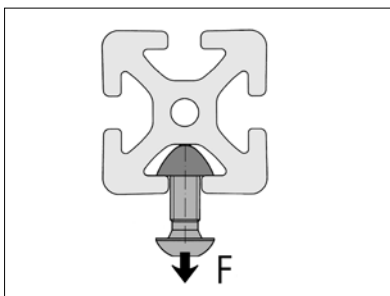

Groove shape	5	6	8	10	12
Normal	500 N	1,750 N	5,000 N	7,000 N	10,000 N
Light		500 N	2,500 N		5,000 N
E			1,750 N	3,500 N	

The permissible tensile forces F on the groove flanks. These nominal loads include safety factors (S > 2) against plastic deformation.

Torsion

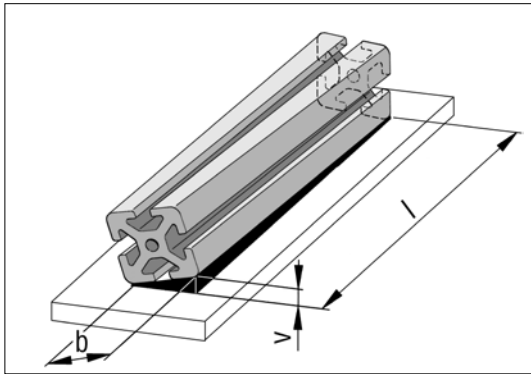

b [mm]		Torsion tolerance v for Length l [mm]					
from	up to	up to 1,000	up to 2,000	up to 3,000	up to 4,000	up to 5,000	up to 6,000
-	25	1.0	1.5	1.5	2.0	2.0	2.0
25	50	1.0	1.2	1.5	1.8	2.0	2.0
50	75	1.0	1.2	1.2	1.5	2.0	2.0
75	100	1.0	1.5	1.8	2.2	2.5	3.0
100	125	1.2	1.5	1.8	2.2	2.5	3.0
125	150	1.2	1.5	1.8	2.2	2.5	3.0
150	200	1.5	1.8	2.2	2.6	3.0	3.5
200	300	1.8	2.5	3.0	3.5	4.0	4.5
300	320	2.0	2.0	3.5	4.0	4.5	5.0

Straightness Tolerance transverse

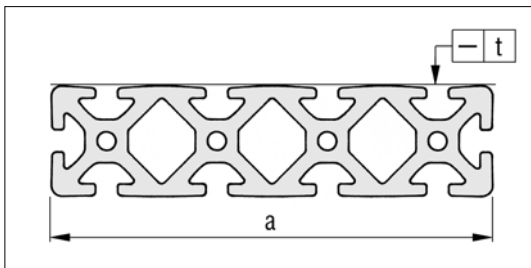

Width a [mm]		Straightness Tolerance
from	up to	t [mm]
0	80	0.3
80	120	0.4
120	160	0.5
160	240	0.7
240	320	1.0

## Straightness Tolerance longitudinal

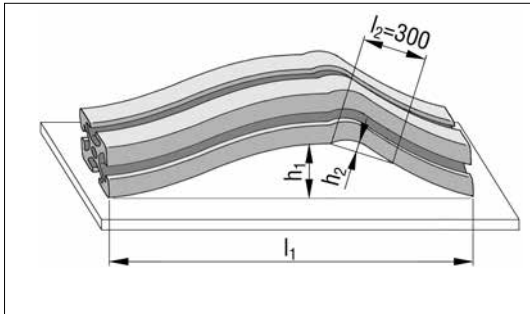

Length		Tolerances	
$l_1$ [mm]	$h_1$ [mm]	$h_2$	
up to 1,000	0.7	For every length section of $l_2 = 300$ mm, a maximum deviation of 0.3 mm is allowed	
up to 2,000	1.3		
up to 3,000	1.8		
up to 4,000	2.2		
up to 5,000	2.6		
up to 6,000	3.0		

## Angular Tolerance

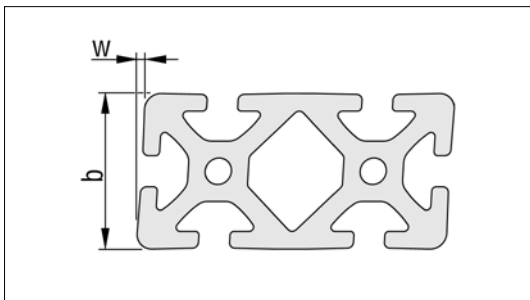

Width b [mm]		Angular Tolerance
from	up to	$w \pm$ [mm]
0	20	0.2
20	40	0.4
40	80	0.6
80	120	0.8
120	200	1.2
200		1.5

## Construction profiles: Determination of the Profile Deflection

The following equations apply for calculating deflection f:

Example load 1

$$f = \frac{F \times l^3}{3 \times E \times I \times 10^4}$$

Example load 2

$$f = \frac{F \times l^3}{48 \times E \times I \times 10^4}$$

Example load 3

$$f = \frac{F \times l^3}{192 \times E \times I \times 10^4}$$

The following equations are to be used for calculating the deflection caused by the dead weight:

As example load 1

$$f = \frac{F \times l^3}{8 \times E \times I \times 10^4}$$

As example load 2

$$f = \frac{5 \times F \times l^3}{384 \times E \times I \times 10^4}$$

As example load 3

$$f = \frac{F \times l^3}{384 \times E \times I \times 10^4}$$

F = Load in N  
 l = Free profile length in mm  
 I = Moment of inertia in cm<sup>4</sup>  
 E = Modulus of elasticity in N/mm<sup>2</sup>  
 E<sub>Al</sub> = 70,000 N/mm<sup>2</sup>

An approximate calculation of the deflection is possible with the help of the nomogram shown on the right.  
 The example shown is worked through in the direction of the arrow to determine the deflection.

**Example:**

**Given:**

F = 1,000 N

l = 500 mm

I<sub>y</sub> = 5,14 cm<sup>4</sup> (Profile 5 40x20, upright)

**Find:**

f = Deflection in mm

**Results:**

Example load 1

f = 11.6 mm

Example load 2

f = 0.72 mm

Example load 3

f = 0.18 mm

The bending values that are either calculated or determined using graphs must be added to the deflection caused by the dead weight of the profiles.

For an approximate calculation of the deflection caused by the dead weight, the dead weight is entered as F in the nomogram and the resulting values should be halved.

**Check of the bending stress**

$$\sigma = \frac{M_b}{W \times 10^3}$$

σ = Bending stress in N/mm<sup>2</sup>  
 M<sub>b</sub> = Max. bending moment in Nmm  
 W = Resistance moment in cm<sup>3</sup>  
 Rp<sub>0,2Al</sub> = 195 N/mm<sup>2</sup>

The calculated bending stress σ must be compared with the permissible bending stress σ<sub>perm</sub>.

$$\sigma_{perm} = \frac{Rp_{0,2}}{S}$$

The safety factor S must be selected depending on the required application conditions.



### Note:

Calculate the deflection in a profile easily online: A profile deflection calculator that takes into account all three load scenarios is available online at [www.item24.com](http://www.item24.com).

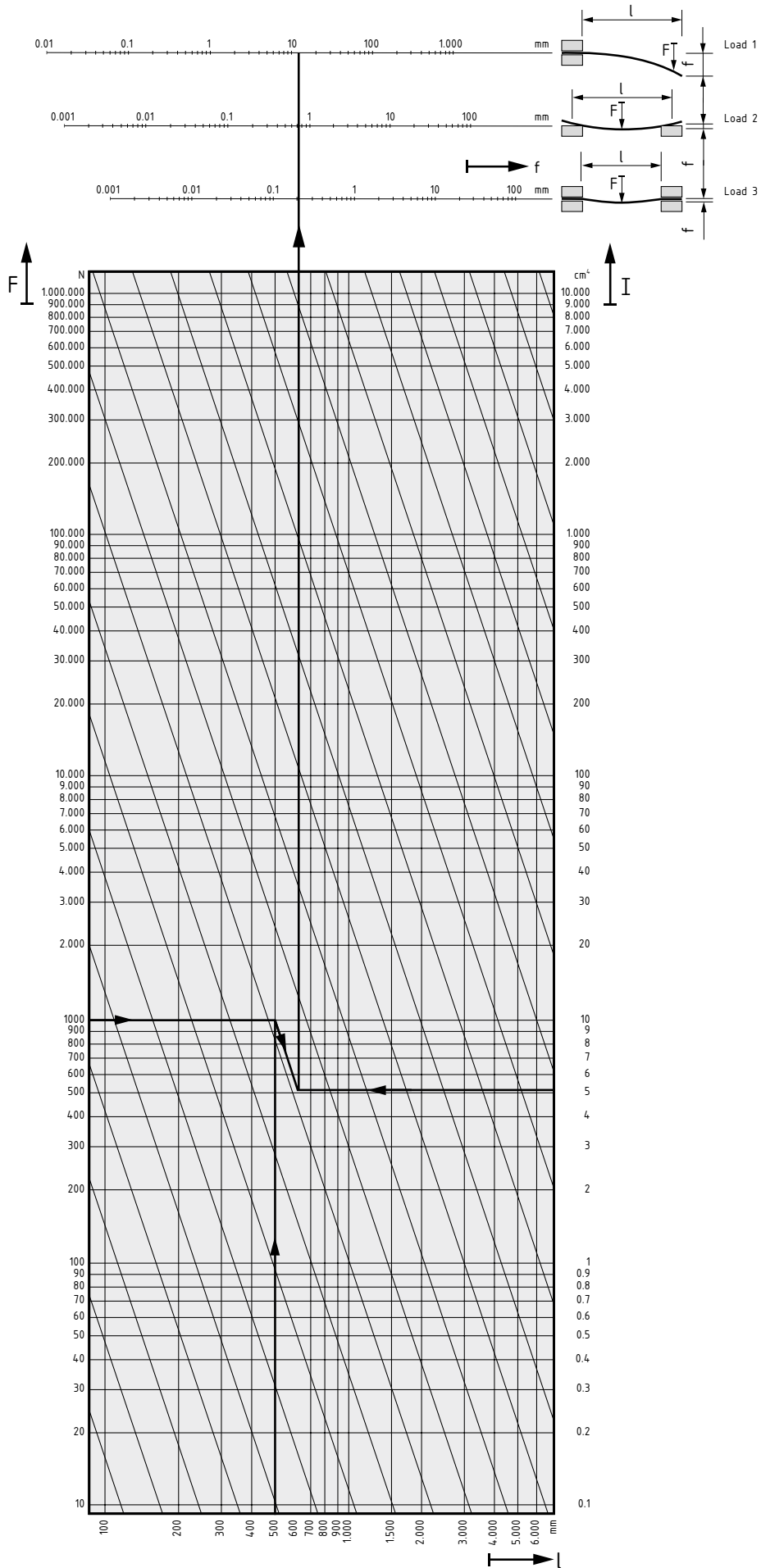

## Construction profiles: Determination of the torsion angle

The following equations apply for calculating the torsion angle  $\vartheta$  :

Example load 1

$$\vartheta = \frac{180^\circ \times M_t \times l}{\pi \times G \times I_t \times 10}$$

Example load 2

$$\vartheta = \frac{180^\circ \times M_t \times l}{\pi \times 4 \times G \times I_t \times 10}$$

Where:

$M_t$  = Torsional moment in Nm

$l$  = Free profile length in mm

$I_t$  = Moment of inertia in  $\text{cm}^4$

$G$  = Modulus of rigidity in  $\text{N/mm}^2$

$G_{Al} = 25,000 \text{ N/mm}^2$

$\vartheta$  = Torsion angle in decimal degrees

The example shown on the nomogram opposite is based on the free profile length and a given torsional moment. The result is the torsion angle as a deformation of Profile 8 80x80.

It is naturally also possible to use the nomogram in reverse and begin with a maximum permissible torsion to calculate the required profile sizes or the maximum loading moments for a specified profile length.

**Example:**

**Given:**

$M_t = 20\text{Nm}$

$l = 2,000 \text{ mm}$

$I_t = 136.98 \text{ cm}^4$  (Profile 8 80x80)

**Find:**

$\vartheta$  = Torsion angle in decimal degrees

**Results:**

Example load 1

$\vartheta = 0.07^\circ$

Example load 2

$\vartheta = 0.02^\circ$

The values for the profiles' torsional moments of inertia were determined experimentally or through an approximate calculation. Component tolerances and simplifying assumptions mean the actual torsion angles can differ from the calculated value by up to 15%.

### Check of the torsional stress

In practice, the criterion for a profile to fail under a torsional load is less the fact that the permissible torsional stress is exceeded, but rather the presence of excessive twist (torsion angle) even though it is still within the elastic limit. This deformation greatly impairs correct functioning of the components. Consequently, a more torsionally rigid profile must be selected long before the permissible stress values are reached.

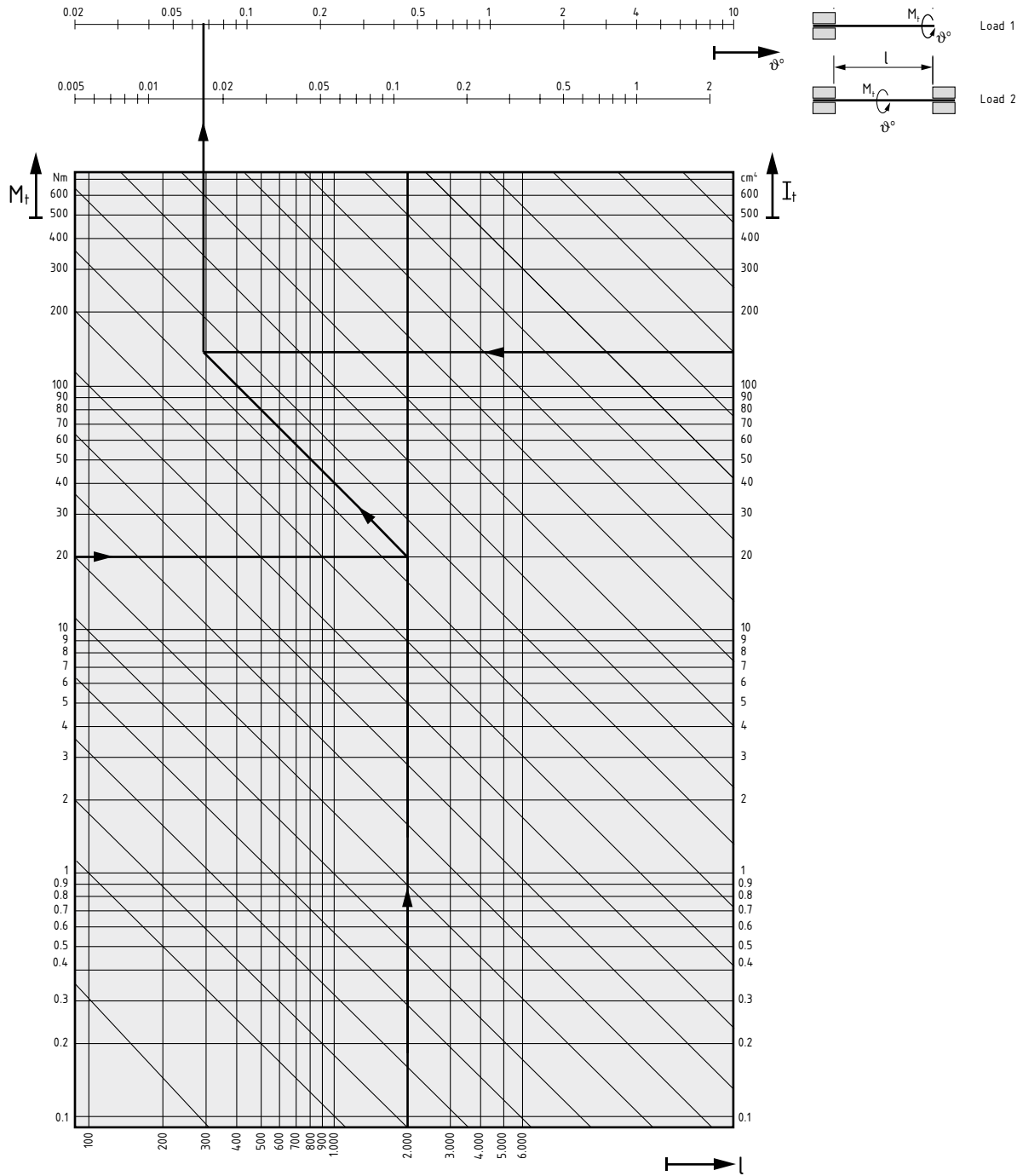



## Recommended Assembly Configurations

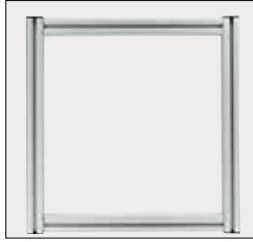
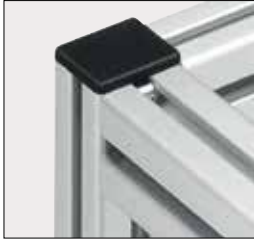

Where possible, the vertical profiles should extend through the entire height; this simplifies connection of the floor elements and improves the overall appearance.

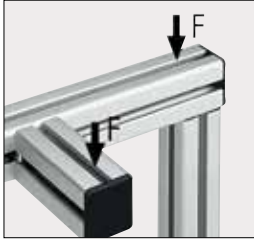

Structures should be designed to withstand the loads likely to be placed on them, i.e. by avoiding torsional stress at the connection points and by giving preference to positive locking over friction resistance in the direction of applied force in all the connections.

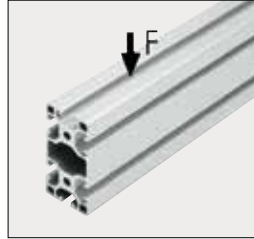

Where possible, profiles should be installed so that the largest section dimension opposes the load in order to achieve the maximum flexural strength.



Avoid breaks in the supporting profile when installing additional attachments; the benefits include greater stability, fewer cuts, fewer connections and reduced assembly time.



Extend the profiles only with the aid of the corresponding fastening elements and, where possible, support them at the joints.



If it is not possible to avoid anodized surfaces being in direct contact with one another, the contact points must be greased. This will help to avoid any noise which might result from movement.



If profile-based structures are likely to be exposed to extremes of stress, e.g. impact loads, which might cause displacement at the points of attachment, pin elements should be installed in order to provide additional support.