

Automated Nonlinear Analysis of Newborn Electroencephalographic Signals

Vladana Radisavljevic Djordjevic

Doctoral Thesis

Ph.D. Programme: Electrical Engineering and Information Technology
Branch of study: Artificial Intelligence and Biocybernetics

Prague, January 2015.

Supervisor: Doc. Ing. Lenka Lhotska, CSc.



Czech Technical University in Prague
Faculty of Electrical Engineering
Department of Cybernetics
Prague, Czech Republic

Acknowledgement

I would like to thank my supervisor Doc. Ing. Lenka Lhotska, CSc. for her support and cooperation, and without her this work would not be possible. I would like to thank also my colleague Vaclav Gerla, PhD for the long term collaboration, other colleagues from the BioDat lab and Karel Paul, MD.

I owe special gratitude to my family for their unconditional support and optimism. In addition, I would like to thank my friends for their support.

Abstract

Electroencephalography (EEG) is the measurement of brain electrical activity by means of electrodes positioned on the scalp, which has many important applications in medicine. From one side, visual inspection of EEG signal by neurologists is time consuming, tedious, subjective and based on the previous experience and available information about the state of patient's health. From the other side, automated classification of EEG signals is also a very difficult task, due to signals' wide variability, high complexity and low resilience to interferences, especially when they are recorded during a long time period. In most cases, the agreement of an automatic method with visual analysis is a basis criterion for its acceptance. Today, as well as in the previous decade, a variety of signal processing techniques is being applied on EEG data.

Therefore, in this thesis a comprehensive methodology has been proposed for automatic recognition of behavioral states in neonatal sleep EEG. The methodology is based on preprocessing, data representation and classification. The attention was focused on data representation stage in the multistage processing system, namely representation of signal by extracted features. This stage is very important in the analysis of EEG signals in the computational data processing, as it directly affects the classification accuracy. Specifically extracted nonlinear features, whose classification potential was tested, were Hurst exponent and approximate entropy, calculated both for the raw signal and signal after the application of wavelet transform. The methodology was optimized for EEG signal processing in the field of sleep studies in newborns and verified on real clinical neonatal data. Thus this thesis provides a reference for enhancing the differentiation of individual neurological states and for the improvement of existing approaches.

Keywords Electroencephalography, polysomnography, neonate, sleep, nonlinear, signal processing, feature extraction, wavelet transform, Hurst exponent, approximate entropy, classification

Abstrakt

Elektroencefalografie (EEG) je měření elektrické aktivity mozku pomocí elektrod umístěných na povrchu hlavy, které se používá v řadě významných aplikací v medicíně. Vizuální analýza EEG signálu je časově náročný, zdlouhavý a subjektivní proces, který provádějí neurologové na základě předchozích zkušeností a dostupných informací o zdravotním stavu pacienta. Současně ale i automatizované zpracování EEG signálu představuje velmi náročný úkol, vzhledem k široké variabilitě signálu, vysoké složitosti a nízké odolnosti vůči rušení, především pokud se jedná o dlouhodobé EEG záznamy. Shoda automatizované metody s vizuální analýzou je většinou základem pro přijetí takové metody. V současné době, stejně jako v předchozím desetiletí, jsou na EEG záznamy používané různé metody zpracování signálu.

V této práci je navrhována metodologie pro automatizované rozlišování novorozeneckých spánkových stavů na základě EEG záznamů. Metodologie je založena na předzpracování, reprezentaci dat a klasifikaci. Pozornost v této práci byla zaměřena především na reprezentace dat, zejména na extrakci příznaků, ve víceúrovňovém systému pro automatizované zpracování dat. Extrakce příznaků má velký význam pro zpracování EEG signálu vzhledem k tomu, že má přímý vliv na přesnost klasifikace. Nelineární příznaky, Hurstův exponent a aproximativní entropie, jejichž potenciál pro klasifikaci byl testován, byly vypočítané pro nezpracovaný signál a signál po použití waveletové transformace. Metodologie byla optimalizována pro zpracování novorozeneckých spánkových EEG signálů a otestována na reálných klinických datech. Tudíž výsledky této práce mohou být použity pro zlepšení klasifikace jednotlivých neurologických stavů a pro zlepšení současných metod.

Klíčová slova Elektroencefalografie polysomnografie, novorozenecký, spanek, zpracování signálu, extrakce příznaků, wavelet transformace, Hurst exponent, aproximativní entropie, klasifikace

Contents

Acknowledgement	I
Abstract	III
Abstrakt	V
Contents	VII
List of abbreviations.....	XI
Chapter 1	1
Introduction.....	1
1.1. Goals of the thesis	2
1.2. Structure of the thesis.....	3
1.3. Declaration of previous work.....	3
Chapter 2.....	7
Electroencephalography.....	7
2.1. History of EEG – brief overview	7
2.2. Brain anatomy	8
2.3. Basic activity and measurement.....	8
2.4. Position of electrodes and montages	9
2.5. Artifacts.....	10
2.6. Applications	11
2.7. Polysomnography.....	12
2.8. Sleep.....	13
2.9. Epilepsy.....	14
2.10. Coma	14
2.11. Cognitive studies.....	15
Chapter 3.....	17
State of the art	17
3.1. Sleep studies.....	17

3.2. Neonatal EEG analysis	19
3.3. Neonatal EEG sleep analysis.....	20
3.4. Application of approximate entropy.....	21
3.5. Application of Hurst exponent	22
3.6. Automated EEG analysis.....	22
Chapter 4	25
Stages in EEG signal processing	25
4.1. Typical stages in EEG signal processing.....	25
4.2. Preprocessing.....	26
4.2.1. Segmentation	27
4.3. Data representation.....	27
4.3.1. Wavelet transform – brief overview.....	29
4.4. Classification	31
4.4.1. Naive Bayes classifier	32
4.5. Optimization and visualization.....	33
4.6. Assessment of classification performance.....	33
Chapter 5	35
System realization	35
5.1. PSGlab.....	35
5.2. Methods implemented in PSGlab.....	36
5.2.1. Information extraction.....	37
5.3. Applications.....	39
Chapter 6	41
Dataset.....	41
Chapter 7	45
Approximate entropy-based sleep staging.....	45
7.1. Theoretical background.....	45

7.2. Implemented system description.....	47
7.3. Results.....	50
7.4. Discussion.....	55
7.4.1. Novelty and significance.....	56
Chapter 8.....	59
Analysis based on Hurst exponent.....	59
8.1. Theoretical background.....	59
8.2. Implemented system and results.....	60
8.3. Discussion.....	69
8.3.1. Novelty and significance.....	70
Conclusion and outlook to the future.....	71
9.1. Accomplishment of the objectives.....	72
9.2. Future work.....	73
Bibliography.....	75

List of abbreviations

AACM	American Academy of Sleep Medicine
ApEn	Approximate Entropy
DWT	Discrete Wavelet Transform
ECG	Electrocardiograms
EEG	Electroencephalogram
EMG	Electromyogram
EOG	Electrooculogram
FT	Fourier Transform
FFT	Fast Fourier Transform
MRA	Multi Resolution Analysis
NREM	Non-rapid eye movement
PCA	Principal Component Analysis
PNG	Pneumogram
PSD	Power Spectral Density
PSG	Polysomnography
REM	Rapid Eye Movement
STD	Standard Deviation
STFT	Short-time Fourier Transform
WT	Wavelet Transform

Chapter 1

Introduction

Electroencephalography is noninvasive measurement of brain electrical activity by means of electrodes positioned on the scalp. It has many important applications in medicine. EEG is considered to be the most important diagnostic tool in neurology. The wide range of EEG applications encompasses the field of epilepsy, sleep and coma. A common basis that all these fields share is necessity for long-term recordings.

Even since its introduction, electroencephalography has been evolving, both in medical and technical aspects. But visual inspection still remains widespread method of EEG signal analysis. Neurologists usually inspect the EEG signal on a computer screen, looking at a certain time interval of recordings (for example, 30 seconds for the sleep EEG), and classify the brain activity into different classes/stages. Neurologists today use atlases (both in paper and electronic form) to evaluate EEG data and make evaluation based on their professional experience obtained in clinical practice, as well as on available information about the patient and the state of patient's health (e.g. age, gender, prescribed medication, family predisposition to diseases, etc.). However, this kind of visual approach may not be always appropriate, especially with long-term EEG recordings. Evaluation of this kind of recordings is tedious and time consuming.

In order to simplify the work of neurologists, computer assisted processing methodologies and systems are developed. The aim of these systems is also to make the evaluation of long-term EEG recordings more objective, and visualize results and represent them in a convenient form. In most cases, the agreement of an automatic method with visual analysis is a basic criterion for its acceptance.

Automated systems cannot, and are not intended to, fully replace neurologists. Their primary aim, especially for long-term EEG analysis, is to support the evaluation of medical doctors, but also to make their work more efficient. Computer assisted processing of EEG recordings may provide objective data in graphical or numerical form and permits computation and analyses of EEG features which were not possible only by visual analysis. For example, automated systems may identify and mark segments of the signal where deviations from standard brain activity are present, or

assign signal segments to predefined class or stage, and this way may shorten the time required for visual inspection of the recording.

Ultimate goal of computer-assisted processing is to provide usable, reliable and automated classification of PSG/EEG recordings, in different fields of application, in everyday clinical practice.

1.1. Goals of the thesis

The main goal is to propose a methodology of electroencephalographic (EEG) signal analysis that would support the clinicians with assessment of EEG or polysomnographic (PSG) recordings. The attention was focused specially on data representation stage in the multistage processing system, namely representation of EEG signal by extracted nonlinear features. The main goals of the thesis can be summarized as follows:

1. *Development of a novel methodology for neonatal sleep EEG analysis.* Automated processing of EEG/PSG signals was already addressed in numerous studies. Most of them use a small dataset, consisting of a few minutes or a single EEG electrode channel, or artificially generated biological signals. Also, some of the reported studies evaluate the data only from a medical perspective. This thesis is based on the research conducted in order to develop a new methodology for computer assisted processing and evaluation of sleep EEG signals, appropriate for neonatal EEG. The proposed solution should deal with an unknown multichannel EEG signal.
2. *Extraction of clinically relevant information.* This goal encompasses the design and testing of different features, with focus on nonlinear features, extracted from clinical neonatal PSG sleep recordings. This way, informative parameters should be extracted from available signals. As multichannel EEG is inseparable part of clinical neonatal PSG recordings, it is possible to combine the available information and use it in the most appropriate way.
3. *Verification of sufficiency of the EEG based information.* Available dataset consisted of the clinical polysomnographic sleep data of newborns, recorded in a medical institution. Only EEG channels from available PSG recordings were included in the analysis. This way, it should be verified if EEG signal contains sufficient information for the differentiation of the neonatal behavioral state and if this information could be extracted by the proposed methodology. Also, this enables the reduction of time necessary for the automatic signal processing, as other available biological signals do not need to be processed.
4. *Verification of a classification potential of extracted features on real clinical recordings.* This goal encompasses the verification if extracted nonlinear features reflect complex sleep behavioral states in newborns, namely quiet and active sleep, and if they are suitable for their discrimination. This way, the

proposed system will have the basis to provide accurate information about the presence of the specific behavioral states and thus clinically relevant information, e.g. about the maturation of the newborn brain.

1.2. Structure of the thesis

The rest of the thesis is organized as follows. Chapter 2 provides a brief overview of the history of EEG, followed by the general summary about EEG, way of its recording and fields of application. In Chapter 3, the state of the art of evaluation of EEG/PSG signals is presented, with focus on neonatal and sleep EEG. Chapter 4 encompasses description of general multilevel EEG/PSG evaluation process, while Chapter 5 gives description of system realization. Details about available clinical recordings and used dataset are given in Chapter 6. Chapter 7 introduces approximate entropy-based distinction of EEG sleep stages. Also in this Chapter results obtained with proposed methodology are presented and discussed. In Chapter 8, analysis of full-term newborn EEG sleep signals based on the Hurst exponent is presented, together with obtained results. The final Chapter 9 gives concluding remarks and outline of the future work.

1.3. Declaration of previous work

Journal papers

Djordjevič, V. - Gerla, V. - Huptych, M. - Lhotská, L. - Krajča, V.: The Development of Modules for the Support of Education in the Field of Biomedical Engineering. *Elektronika ir Elektrotechnika*. 2010, vol. 102, no. 6, p. 47-50.

Conference papers

Radisavljevič Djordjevič, V. - Gerla, V. - Lhotská, L. - Krajča, V.: EEG Based Sleep Staging in Term Newborns. In *IFMBE Proceedings: World Congress on Medical Physics and Biomedical Engineering*. Heidelberg: Springer, 2013, vol. 39, p. 348-351.

Gerla, V. - Radisavljevič Djordjevič, V. - Lhotská, L. - Krajča, V.: Feature Selection for Adults Sleep and Neonatal Polysomnographic Data. In *IFMBE Proceedings: World Congress on Medical Physics and Biomedical Engineering*. Heidelberg: Springer, 2013, vol. 39, p. 538-541.

Gerla, V. - Murgaš, M. - Radisavljevič Djordjevič, V. - Lhotská, L. - Krajča, V.: Incremental Learning in the Task of EEG Data Classification. In *Program a sborník*

abstrakt - 60. Společný sjezd české a Slovenské společnosti pro klinickou neurofyzilogii. 2013, p. 14-15.

Radisavljevič Djordjevič, V. - Gerla, V. - Bělobrádek, R. - Lhotská, L. - Krajča, V.: Wavelet Transform Based Features for Analysis of Newborn Behavioral States. *Clinical Neurophysiology*. 2012, vol. 123, no. 3, p. e14-e15.

Gerla, V. - Radisavljevič Djordjevič, V. - Macaš, M. - Lhotská, L. - Krajča, V.: Automated Analysis of Long-Term EEG Recordings. In *Česká a slovenská neurologie a neurochirurgie*. Praha: Česká lékařská společnost J. E. Purkyně, 2012, díl 75, s. 20-21. (in Czech).

Gerla, V. - Radisavljevič Djordjevič, V. - Lhotská, L. - Krajča, V. - Paul, K.: Analysis of Newborn EEG Recorded at 40th Week of Postconceptional Age. *Clinical Neurophysiology*. 2012, vol. 123, no. 3, p. e14.

Gerla, V. - Radisavljevič Djordjevič, V. - Lhotská, L.: Polysomnographic Data Processing Toolbox for Matlab. Authorized software. 2011.

Djordjevič, V. - Gerla, V. - Lhotská, L. - Krajča, V.: A Decision Support Tool in the Field of Electroencephalography. In *10th International Conference on Information Technology and Applications in Biomedicine*. Crete: IEEE Control Syst Soc, 2010.

Gerla, V. - Djordjevič, V. - Lhotská, L. - Krajča, V.: PSGLab Matlab Toolbox for Polysomnographic Data Processing: Development and Practical Application. In *10th International Conference on Information Technology and Applications in Biomedicine*. Crete: IEEE Control Syst Soc, 2010.

Djordjevič, V. - Gerla, V. - Petránek, S. - Krajča, V. - Lhotská, L.: Contribution to Advanced EEG Processing. In *Workshop 2010*. Praha: České vysoké učení technické v Praze, 2010, p. 278-279.

Gerla, V. - Djordjevič, V. - Vavrečka, M. - Lhotská, L. - Krajča, V.: Application of Clustering for Increasing the Evaluation Objectivity of Electroencephalographic Recordings. In *Proceedings of Biosignal 2010: Analysis of Biomedical Signals and Images*. Brno: Brno University of Technology, 2010, p. 398-404.

Djordjevič, V. - Gerla, V. - Lhotská, L.: Processing of EEG Sleep Recordings in Newborns. In *Workshop 2010*. Praha: České vysoké učení technické v Praze, 2010, p. 300-301.

Djordjevič, V. - Gerla, V. - Lhotská, L. - Krajča, V.: The application of mathematical transforms for extraction of hidden information from EEG recordings. In *57. SPOLEČNÝ SJEZD ČESKÉ A SLOVENSKÉ SPOLEČNOSTI PRO KLINICKOU NEUROFYZIOLOGII*. Praha: MH Consulting, 2010, s. 57. (in Czech).

Gerla, V. - Djordjevič, V. - Vavrečka, M. - Lhotská, L. - Krajča, V.: Automated analysis of longterm EEG recordings. In *57. SPOLEČNÝ SJEZD ČESKÉ A SLOVENSKÉ*

SPOLEČNOSTI PRO KLINICKOU NEUROFYZIOLOGII. Praha: MH Consulting, 2010, s. 51. (in Czech).

Djordjevič, V. - Lhotská, L.: Discrimination of EEG Correlates of Emotions. In *Workshop Nadace ČVUT MEDIA LAB 2010*. Praha: Nadace ČVUT MEDIA LAB, 2010, p. 3.

Djordjevič, V. - Gerla, V. - Huptych, M. - Lhotská, L. - Krajca, V.: The Development of Modules for the Support of Education in the Field of Biomedical Engineering. In *21st EAEEIE Annual Conference*. Kaunas: Kauno technologijos universitetas, 2010, p. 47-50.

Djordjevič, V. - Gerla, V. - Lhotská, L. - Krajca, V.: Multimedia Support in the Field of Biomedical Engineering. In *MEDSOFT 2010*. Praha: Action M, 2010, s. 28-33. (in Czech).

Djordjevič, V. - Reljin, N. - Gerla, V. - Lhotská, L. - Krajča, V.: Feature Extraction and Classification of EEG Sleep Recordings in Newborns. In *Proceedings of 9th International Conference on Information Technology and Applications in Biomedicine*. Piscataway: IEEE, 2009.

Djordjevič, V. - Gerla, V. - Lhotská, L. - Krajča, V. - Paul, K.: Improvements in Processing of Neonatal Sleep Electroencephalographic Recordings. In *World Congress on Medical Physics and Biomedical Engineering, September 7 - 12, 2009, Munich, Germany*. Berlin: Springer Science+Business Media, 2009, p. 2215-2218.

Djordjevič, V. - Gerla, V. - Huptych, M. - Lhotská, L. - Krajča, V.: Multimedia Support in the Field of Interdisciplinary Education. In *20th EAEEIE Annual Conference Innovation in Education for Electrical and Information Engineering*. Valencia: Universidad Politécnica de Valencia, 2009.

Gerla, V. - Djordjevič, V. - Lhotská, L. - Krajča, V.: System Approach to Complex Signal Processing Task. In *Computer Aided Systems Theory - Revised Selected Papers*. Heidelberg: Springer, 2009, p. 579-586.

Gerla, V. - Djordjevič, V. - Lhotská, L. - Krajča, V.: Visualization Methods Used for Evaluation of Neonatal Polysomnographic Data. In *Proceedings of 9th International Conference on Information Technology and Applications in Biomedicine*. Piscataway: IEEE, 2009.

Gerla, V. - Macaš, M. - Lhotská, L. - Djordjevič, V. - Krajča, V. - et al.: Wards Clustering Method for Distinction Between Neonatal Sleep Stages. In *World Congress on Medical Physics and Biomedical Engineering, September 7 - 12, 2009, Munich, Germany*. Berlin: Springer Science+Business Media, 2009, p. 786-789.

Djordjevič, V. - Gerla, V. - Huptych, M. - Lhotská, L. - Krajča, V.: Multimedia Support in the Field of EEG in Educational Purposes. In *Proceedings of the 8th Czech-Slovak*

Conference Trends in Biomedical Engineering. Bratislava: Slovak University of Technology in Bratislava, 2009. (in Czech).

Djordjevič, V. - Gerla, V. - Lhotská, L. - Krajča, V. - Paul, K.: Utilization of Transforms for EEG Feature Extraction. In *Workshop 09 CTU REPORTS*. Prague: CTU, 2009, p. 326-327.

Gerla, V. - Djordjevič, V. - Lhotská, L. - Krajča, V.: System Approach to Complex Signal Processing Task. In *Computer Aided Systems Theory EUROCAST 2009*. Las Palmas: University of Las Palmas de Gran Canaria, 2009, p. 191-192.

Djordjevič, V. - Gerla, V. - Lhotská, L.: Methodology of Newborn EEG Data Classification. In 55. *Společný sjezd české a slovenské společnosti klinické neurofyziologie*. Brno: MSD, 2008, díl 1, s. 15. (in Czech).

Gerla, V. - Djordjevič, V. - Lhotská, L. - Krajča, V. - Paul, K.: Using Hierarchical Clustering for Classification of EEG Signals. In 55. *Společný sjezd české a slovenské společnosti klinické neurofyziologie*. Brno: MSD, 2008, díl 1, s. 19. (in Czech).

Lhotská, L. - Gerla, V. - Djordjevič, V. - Krajča, V.: Visualization methods for EEG and PSG data. In 55. *Společný sjezd české a slovenské společnosti klinické neurofyziologie*. Brno: MSD, 2008, díl 1, s. 36. (in Czech).

Other publications

Lhotská, L. - Radisavljevič Djordjevič, V.: IT and Engineering Education: How to Make It More Attractive for Women. In *Global Telemedicine and eHealth Updates: Knowledge Resources*. Grimbergen: International Society for Telemedicine and eHealth (ISfTeH), 2014, p. 622-625.

Lhotská, L. - Radisavljevič Djordjevič, V.: Gender Ratio in Engineering Disciplines: Why Are There Differences. In *Global Telemedicine and eHealth Updates: Knowledge Resources*. Grimbergen: International Society for Telemedicine and eHealth (ISfTeH), 2013, vol. 6, p. 268-272.

Djordjevič, V. - Lhotská, L. - Gerla, V.: Gender Ratio in Biomedical Engineering. In *Proceedings of the 22nd EAEEIE Annual Conference*. Maribor: University of Maribor, 2011, p. 56-61.

Chapter 2

Electroencephalography

2.1. History of EEG – brief overview

The first demonstration of recording human brain electrical activity was published in 1929 by the German psychiatrist Johannes Berger. In this report, Berger used two large pad electrodes soaked in saline, one placed over the forehead and the other placed at the back of the head. He observed that there were regular rhythmic waves at about 10Hz in relaxed subjects and noticed that these waves were best seen when subjects had their eyes closed in the absence of stimulation or other mental activity such as imaging or problem solving. These waves subsequently became known as alpha waves [1].

Berger's first report was greeted with considerable skepticism in the scientific community. The electroencephalographic measures became more widely accepted in the biomedical research community after a live demonstration of scalp-recorded brain activity at the meeting of the Physiological Society in London in 1935. After World War II, EEG became a leading clinical and experimental tool in neurology.

The first International EEG congress was held in London in 1947. It was recognized that a standard method of placement of electrodes used in EEG was needed. Possible methods to standardize electrode placement were studied by H. H. Jasper, which resulted in the definition of 10-20 electrode system in 1958 [2]. Since then, the 10-20 electrode system has become de facto standard for clinical EEG. In 1985 an extension to this system was proposed which involved an increase of the number of electrodes from 21 up to 74. This extended system has been accepted and it is known as the 10-10 system. Larger number of electrodes can be used today in order to obtain high-resolution EEG measurements and mapping of brain activity.

Improvements in analog EEG recording were made by increasing the number of recording channels, refining penwriting, and improving amplifiers with the use of vacuum tubes and then transistors [3]. This technology is nowadays replaced with digital EEG. It has dramatically expanded clinical capabilities by providing greater efficiency in data storage and improved data visualization techniques. Also, the scope of analysis is broadened by the possibility of analyzing an event in playback, with different montages, modifying voltage and speed, or using filters.

2.2. Brain anatomy

The brain consists of 10^{10} - 10^{11} neurons that are very closely interconnected via axons and dendrites [4]. One neuron may receive stimuli through synapses from as many as 10^3 to 10^5 other neurons. From an anatomical point of view the brain may be divided into three parts: the cerebrum, cerebellum, and brain stem, as shown in Figure 2.1.

The entire human brain weighs about 1500g. The cerebrum is the largest part of the brain. The surface of the cerebrum is strongly folded. These folds are divided into two hemispheres which are separated by a deep fissure and connected by the corpus callosum. Existing within the brain, there are three ventricles containing cerebrospinal fluid. The hemispheres are divided into the following lobes: lobus frontalis, lobus parietalis, lobus occipitalis, and lobus temporalis. The surface area of the cerebrum is about 1600cm^2 , and its thickness is 3mm.

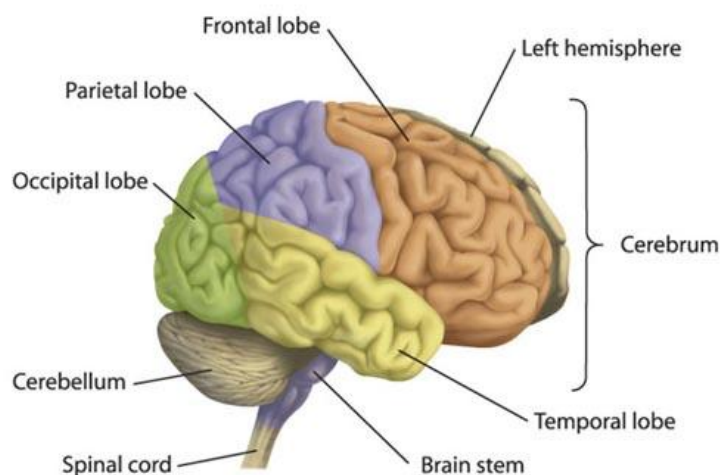

Figure 2.1: Major external parts of the human brain [5].

Neurons are the basic data processing units of the brain. Each neuron receives electrical inputs from other neurons. Impulses arriving simultaneously are added together and, if sufficiently strong, lead to the generation of an electrical discharge, known as an action potential (a “nerve impulse”). The action potential then forms the input to the next neuron in the network.

2.3. Basic activity and measurement

EEG shows continuous electric activity. In the frequency domain, we can distinguish four basic frequency bands of EEG signal, namely delta, theta, alpha and beta activities [6], [7], [8]. Generally, EEG is a combination of activity in these frequency bands - as the brain goes through different states the activity in each of the frequency bands changes.

The delta band corresponds to the slowest waves in the range less than 4Hz. The existence of delta wave is normal for children up to three years of age, in deep sleep and hypnosis. During sleep the waves can be higher than 100 μ V in amplitude.

The theta band corresponds to waves in the range of 4-8Hz. Their existence is considered as pathological if their amplitude is at least twice as high as the alpha activity or higher than 30 μ V if alpha activity is absent. The presence of a theta wave is normal if its amplitude is up to 15 μ V and if the waves appear symmetrically. In healthy persons, they appear in central, temporal and parietal parts. This activity is characteristic for certain periods of sleep.

The alpha band corresponds to the waves in the range of 8-12Hz. In the waking state in mental and physical rest the maximum appears in the occipital part of the brain. Its presence is highly influenced by opened or closed eyes. The amplitude is in the range of 20-100 μ V, most frequently around 50 μ V.

The beta band corresponds to the fastest waves in the range of 12-20Hz. The maximum of the activity is mostly localized in the frontal part, and it decreases in the backward direction. The rhythm is mostly symmetrical or nearly symmetrical in the central part. The amplitude is up to 30 μ V. This activity is characteristic for concentration, logical reasoning and feeling of anger or anxiety. Higher frequencies correspond to the gamma band.

The borders of frequency bands are not strictly defined, and in literature different values can be found. The border between delta and theta bands is usually in the range of 3.5 to 4Hz, for theta and alpha bands between 7 and 8Hz, for alpha and beta bands it is between 12 and 14Hz, and gamma band is considered to start with frequencies higher than 20 to 30Hz.

Besides the fact that the EEG signal is age dependent, it is also closely related to the level of consciousness of the person. As the activity increases, the EEG shifts to higher dominating frequency and lower amplitude. When the eyes are closed, the alpha waves begin to dominate the EEG. When the person falls asleep, the dominant EEG frequency decreases. In deep sleep, the EEG has large and slow deflections called delta waves.

2.4. Position of electrodes and montages

Today, the placement of the EEG electrodes is standardized. For the routine clinical practice the International 10-20 system is used. An alphanumeric nomenclature is used to identify each electrode position. The alphabetical part is derived from names of underlying lobes of the brain or other anatomic landmarks: "Fp" stands for frontal-polar, "F" for frontal, "C" for central, "P" for parietal, "O" for occipital, and "T" for temporal. By convention, even numbers refer to the electrodes on the right side, odd numbers refer to the electrodes on the left side, and the letter "z" indicates a midline placement [9].

For 10-20 standard, specific measurements are taken between constant anatomical landmarks to determine the placement of electrodes: the distance from the nasion (bridge of nose) to the inion (the lowest point of the skull form the back of the head), and the distance of the preauricular-to-preauricular line. The position of electrodes in this system is presented in Figure 2.2 [4]. In addition, one or two reference electrodes (often placed on ear lobes) and a ground electrode (often placed on the nose to provide amplifiers with reference voltages) are required.

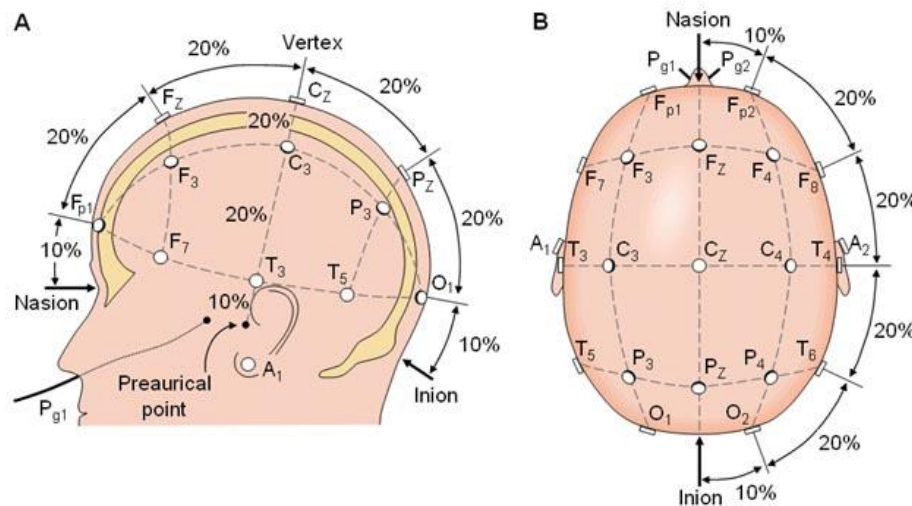

Figure 2.2: The International 10-20 system seen from (A) left and (B) above the head.

Different measurement or electrode montages can be used. Two basic montages are bipolar and referential montages. Bipolar recordings measure potential differences between adjacent scalp electrodes. In referential recordings, potentials between each recording electrode and a fixed reference are measured over time. Bipolar montages can be longitudinal or transversal. With digital EEG devices montages can be changed after the recording was made. Also, with different software packages for EEG signal displaying, different montages are available, e.g. [10].

2.5. Artifacts

Signals naturally contain various artifacts that may occur at many points during the recording process. The range of physiological and nonphysiological artifacts is very wide. They increase the difficulty of analyzing EEG in a way that recordings can be unreadable or artifacts can be misinterpreted as pathological activity. Recognition and elimination of artifacts is a complicated task, usually performed by a human expert. Disadvantage of this approach is that elimination of artifacts means discarding possibly a large amount of data, which can greatly decrease the amount of data available for analysis.

The most general classification of artifacts is to biological and technical artifacts [11]. Concerning EEG, this classification is analogous to the classification to artifacts biologically generated by sources external to the brain and externally generated artifacts.

The most common technical artifacts are 50/60 Hz power line interference, artifacts caused by other electrical devices or low frequency instrumental artifacts. The usual biological artifacts are movement artifacts and artifacts due to the mutual influence of different organs. There is a wide variety of ocular (eye blink, eye flutter, slow/rapid eye movements), muscle (e.g. chewing or swallowing), and cardiac (electrocardiographic, ballistocardiographic) artifacts. Also, artifacts can be generated due to the electrode pop, bad electrode contact, electrode/lead movement or perspiration.

2.6. Applications

Electroencephalography is one of the most important diagnostic tools in neurology. It can be also used in the behavioral sciences, ranging from studies of basic cognitive processes to emotional functions.

The acquired EEG signals from a human may, for example, be used for investigation of the following clinical problems [12]:

- monitoring alertness, coma, and brain death;
- locating areas of damage following head injury, stroke, and tumor;
- testing afferent pathways (by evoked potentials);
- monitoring cognitive engagement;
- producing biofeedback situations;
- controlling anesthesia depth;
- investigating epilepsy and locating seizure origin;
- testing epilepsy drug effects;
- assisting in experimental cortical excision of epileptic focus;
- monitoring the brain development;
- testing drugs for convulsive effects;
- investigating sleep disorders and physiology;
- investigating mental disorders;
- providing a hybrid data recording system together with other imaging modalities.

This list confirms the rich potential for EEG analysis and motivates the need for advanced signal processing techniques to aid the clinicians in their interpretation.

2.7. Polysomnography

Polysomnographic recordings encompass a set of heterogeneous biological signals recorded simultaneously. EEG is an important and inseparable part of this kind of recording. Polysomnographic recording must include electrooculogram (EOG) and electromyogram (EMG). Also, these recordings may include electrocardiogram (ECG), respiratory effort and respiratory airflow, blood oxygen saturation and temperature, as well as movement or body position [13], although some of them are already routinely used in everyday practice.

Polysomnography is the most important laboratory technique for assessment of sleep and its disorders. In adults, it is usually performed over the duration of an entire night, or at least 6.5 hours, in order to investigate normal and disturbed sleep. This way, multiple physiological characteristics are simultaneously recorded during sleep at night.

EOG records corneoretinal (relative positivity at the cornea and a relative negativity at the retina) potential difference. Any eye movement changes the orientation of the dipole and it is the movement of the dipole that is recorded by the EOG [14]. It is a noninvasive procedure, and the recording is made with surface electrodes positioned around eye holes. Several varieties of eye movement are recorded during the routine PSG: waking eye movements, slow eye movements (SEMs) and rapid eye movements (REMs). During wakefulness, both eye blinks and saccadic eye movements are present. During stage I sleep SEMs are recorded and disappear in the deeper stages of non-rapid eye movement (NREM) sleep. During REM sleep phase characteristic REMs appear. REMs typically occur in bursts.

EMG represents electrical activities of muscle fibers as a result of depolarization of the muscles following transmission of electrical impulses along the nerves and neuromuscular junctions. EMG activities are important physiological characteristics that need to be recorded for example for sleep staging as well as for diagnosis and classification of a variety of sleep disorders. There is a fundamental tone in the muscle during wakefulness and NREM sleep, but this is markedly diminished or absent in major muscle groups during REM sleep.

A single channel ECG is sufficient during PSG recordings by placing one electrode over the sternum and the other one at a lateral chest location. This recording may be used, for example, to detect arrhythmias seen in many patients with obstructive apnea syndrome.

Polysomnography is also used for recording of EEG and other polygraphic signals in newborns. It is used primarily for assessment of sleep. Several published studies reported that signals in PSG recordings other than EEG have great importance in the

differentiation of behavioral states in newborns, as they provide important information for their differentiation.

2.8. Sleep

Sleep is a non-uniform biological state. On average, humans spend one third of their time sleeping. During sleep body restores and develops itself. Polysomnography is a valuable aid in diagnosing sleep disorders and a major tool in sleep research. Sleep has been divided into several stages. The standard for terminology and scoring of sleep stages is the manual by Rechtschaffen and Kales (Rechtschaffen and Kales rules) from 1968 [15], which is followed today by the vast majority of sleep laboratories, worldwide. These rules are respected in clinical practice, as well as in research. In 2004, the American Academy of Sleep Medicine (AACM) standards commissioned the AASM Visual Scoring Task Force to review the Rechtschaffen and Kales scoring system [16]. The most significant introduced change was the combining of two stages (stage III and stage IV) into one – stage N3. Besides this, arousals and respiratory, cardiac and movement events were also added to scoring. The revised scoring was published in 2007 as The AASM Manual for the Scoring of Sleep and Associated Events [17].

Sleep stages classification is one of the diagnostic tools needed for the proper assessment of a number of sleep disorders and other neurological problems [14]. In general, the recognition of sleep stages is not based only on the processing of available EEG recordings, but on the use of polysomnographic recordings.

Sleep medicine has experienced steady growth in number of patients, physicians, and sleep centers. According to The American Sleep Disorders Association, there were 77 recognized sleep disorders in the year 2002. Also, according to [18, 19, 16], over 80 different sleep disorders were identified, all of which have associated treatments. The number of recognized sleep disorders and the high prevalence of these disorders in the general population attest to the fact that the appropriate diagnosis and management of a patient presenting with sleep complaint are far from trivial [20]. Nevertheless, although a patient presenting with a sleep complaint is frequently a diagnostic challenge, successful evaluation and management of the sleep disorder, the majority of which are treatable, typically results in a dramatic improvement in the patient's quality of life.

During sleep, typical phenomena or patterns occur, e.g. K-complexes, vertex sharp transients and sleep spindles. K-complex is a brief negative high-voltage peak, followed by a slower positive oscillation, ending in a final negative peak. K-complexes are often followed by sleep spindles [16]. Sleep spindles have typically amplitude lower than voltage peak of the K-complexes, they are maximal in the central region and their frequency is in the beta frequency band. Vertex sharp waves, or vertex waves, also have amplitude lower than K-complex and their duration is shorter.

Normal healthy sleep in adults is organized into sequences of stages that typically cycle every 60-90 minutes. In adults, sleep can be categorized into three states: non-rapid eye movement (NREM), rapid eye movement (REM) and wakefulness. According to the Rechtschaffen and Kales rules, NREM state is divided into four particular stages (stage I, stage II, stage III and stage IV), reflecting a continuum of lighter to deeper sleep [21]. Stages I and II are called light sleep, and stages III and IV are called slow wave sleep or deep sleep. It is becoming more often in the clinical practice to divide NREM state to three stages, by classifying activity of stages III and IV as one stage. This is in line with the reviewed Rechtschaffen and Kales scoring system, published in [17].

Sleep occupies a major portion of the lives of newborns. The ratio of three newborn's behavioral states (wakefulness, active and quiet sleep) is an important indicator of the maturity of the newborn brain in clinical practice [22]. Sleep in newborns is significantly different than sleep in adults. The variability of neonatal EEG signals is related to the fast maturation of the newborn's brain and also to the frequent changes of its behavioral states.

2.9. Epilepsy

One of the major roles of EEG is as an aid to diagnose epilepsy in children and adults. The term epilepsy refers to a group of neurological disorders characterized by the recurrence of sudden reactions of brain function caused by abnormalities in its electrical activity, which is clinically manifested as epileptic seizure [23]. Manifestations of seizures vary greatly, ranging from a brief lapse of attention to a prolonged loss of consciousness; this loss is accompanied by abnormal motor activity affecting the entire body or one or more extremities. The basic classification of epilepsy and epileptic seizures into partial and generalized seizures is widely accepted. Among generalized epilepsy, grand mal and petit mal seizures are the most prevalent.

EEG also provides useful information reflecting the function of the neonatal brain: may assist in identification of focal or generalized abnormalities, existence of potentially epileptogenic foci or ongoing seizures.

It is also important to mention that long-term video EEG/PSG monitoring, as an established method, is also used in clinical practice. For example, video monitoring may be used to assign and connect recorded signals with the sleeping behavior of the patient, as well as for the monitoring of the patients with diagnosed epilepsy.

2.10. Coma

EEG can also be used with comatose patients. Coma is the state of brain function, a profound or deep state of unconsciousness [24]. Comatose states may have a number of causes, from head injury, through cerebral vascular diseases, infectious diseases, brain

tumors, metabolic disorders (failure of liver or kidney), hypoglycemia, to drug overdosing, and many more. A patient in coma does not manifest any notion of higher consciousness, does not communicate, and the functions of his/her inner organs are frequently supported by devices. During the last decades, various individual coma classification systems or scales were developed, and they differ in numbers of levels, ways of examining and precision [25].

2.11. Cognitive studies

EEG is also used in cognitive studies. The investigation of brain asymmetries for cognitive functioning has a long history in neuropsychology [26]. EEG is used, for example, in studies examining changes in asymmetry as a function of state changes in emotions. Cognitive studies provide recordings that are, due to their nature, processed based on the specific methodologies usually applied to evoked potentials. In this kind of studies, it is assumed that changes in EEG asymmetry can be elicited and observed [27]. EEG is used to investigate the differences in brain electrical activity during emotions of positive, negative and neutral valence. Usually emotions are evoked visually by presenting pictures from the International Affective Picture System (IAPS). The IAPS is currently used in experimental investigations of emotions and attention worldwide, providing experimental control in the selection of emotional stimuli, facilitating the comparison of results across different studies, and encouraging replication within and across psychological and neuroscience research laboratories.

Chapter 3

State of the art

As the area of application of EEG is very wide, there is a large number of publications in which authors were dealing with EEG signal processing. In this Chapter, publications related to the topics relevant to this thesis will be listed and presented, namely sleep analysis, neonatal EEG analysis, application of nonlinear features and computer assisted EEG signal processing.

Quantitative EEG analysis is a method predominantly used in research, and usually includes time and frequency domain analysis. This kind of analysis leads to a more objective description of EEG, as well as of other biological signals in general. In addition, visual scoring of EEG recordings, which is used in everyday clinical practice, is time-consuming and tedious. Thus computerized EEG/PSG analyses, being used for example in the field of sleep in adults or neonatal sleep, can provide novel and time-efficient strategies to acquire diagnostic and prognostic information [28].

3.1. Sleep studies

Sleep is a state of reversible unconsciousness in which the brain is less responsive to external stimuli [29]. Electroencephalography, alone or as a part of polysomnography, is one of the major tools in sleep research and a valuable aid in diagnosing sleep disorders. Numerous studies related to sleep assessment, sleep disorders, sleep apnea, monitoring modalities and sleep EEG/PSG signal processing systems and techniques were conducted, and these fields are still very popular in both engineering and medical research communities.

Sleep analysis was an active field of research in the last several decades. Today, there is still a need to increase the quality of automated sleep analysis and developed systems. Results of the automated sleep analysis are usually compared to the visual evaluation made by medical doctors. The difference between a computer assisted sleep staging and visual evaluation cannot be smaller than the differences between different clinicians visually scoring sleep stages. The difference between sleep scorers heavily depends on the training of the scorers – it is likely that scorers attending a common or comparative

methods course will have quite similar scoring results, whereas sleep scorers who have no contact or are from the different parts of the world will have remarkable differences in scoring [16].

Various approaches to sleep analysis and sleep EEG/PSG recordings were reported. Usually these approaches encompass data representation stage followed by classification. In [30] authors presented the study that quantitatively analyzes the EEG characteristics of NREM sleep based on the computation of two nonlinear features – fractal dimension and sample entropy. Method proposed in [31] was developed in order to find the best combination of PSG signals for automated sleep staging (for sleep-wake detection and multiclass sleep staging). Analyzed channels were six EEG channels, two EOG channels and EMG channel. Temporal, frequency and time-frequency features were extracted, and after the classification, it was concluded that the best performance was achieved for the combination of EEG and non-EEG channels. Time and frequency domain features were also extracted in [32]. Also, wide range of classification methods were applied and reported in the literature. Use of different classifiers was suggested, for example, in [33, 34, 35, 36].

EEG dataset used in numerous publications is the dataset available online from the Physionet website. This database contains recordings that encompass Fpz-Cz/Pz-Oz EEG, sampled at 100Hz. Thus not all EEG channels are available for the analyses. In [37] authors proposed the method for classification of EEG sleep stages based on feature extraction and principal component analysis. Extracted features were divided into three groups, namely time-domain features, frequency-domain features and hybrid features. Energy features of EEG signals were used in [38], together with recurrent neural classifier. On the same dataset, a different approach to classification of sleep stages was suggested in [39], where the authors based automated classification on time-frequency image obtained from the time-frequency representation. Automated sleep staging methods based on a single EEG channel was also reported in [40], where a total of 39 features from time domain, frequency domain and nonlinear features (correlation dimension, Lyapunov exponent, approximate entropy, detrended fluctuation analysis, Higuchi fractal dimension, Lempel-ziv complexity) were extracted. Further on, feature subset which could provide significant classification performance was found, and classification was performed based on the application of support vector machine. Some other publications related to the classification of the sleep states in adults, based on the analysis of signal from a single EEG channel, are, for example, [41, 42].

Sleep patterns are also an important research topic. A method for detecting K-complex (a graphoelement occurring at the onset of sleep) using a Continuous Density Hidden Markov Model was given in [43]. In study reported in [44], also an algorithm was proposed for the detection of K-complex from EEG recordings. Automated recognition of sleep spindles in EEG with the use of artificial neural networks was given in [45], and sleep spindles recognition system based on time and frequency domain features was presented in [46]. The identification of both K-complexes and sleep spindles together

was addressed in [47]. As these patterns are typical for the sleep stage II, this work investigated models for the segmentation and automatic labeling of this stage.

3.2. Neonatal EEG analysis

Most of the research in the field on neonatal EEG analysis focuses mainly on detection/classification of epileptic activity. Epilepsy is a type of neurological disorder disease, and it is the second most prevalent neurological disorder in humans after stroke. About 1% of people in the world suffer from epilepsy. The main characteristic of epilepsy is the recurrent seizures, in which abnormal electrical activity in the brain causes altered perception or behavior. Careful analysis of the EEG recordings can provide valuable information for understanding the mechanisms behind epileptic disorders. Since epileptic seizures occur irregularly and unpredictably, automatic seizure detection in EEG recordings is highly required [48].

Many automated epileptic EEG detection systems have been developed using different approaches in the recent years, as indicated in [49]. In [50], authors aimed to develop a comprehensive scheme for patient-independent multichannel EEG-based neonatal seizure detection. Multichannel neonatal seizure detection algorithms trained on real data may represent an important step towards neonatal seizure detection system suitable for clinical deployment.

An efficient algorithm for the automatic detection of seizures in newborn EEG must be able to distinguish between paroxysmal non-ictal bursts and ictal activities [51]. Some of the studies dealing with automatic detection of seizures in newborns are, for example, [52, 53, 54, 55]. Another approach was reported in [56]. Automated method proposed in this study used an optimized subset of wavelet coefficients, selected by the mutual information feature selection method, as input to a classifier.

In [57] authors suggested a multistage classification system for neonatal seizure detection, taking into account specific characteristics of normal and pathological EEG. Proposed system included computation of a total of 132 features, feature selection stage, and classification by artificial neural network. This comprehensive set of features encompassed features obtained by autoregressive modeling, time domain and frequency domain features, as well as features derived from the application of wavelet and cepstral transform. Good performance in detecting newborn ictal activities has been achieved. Another automated EEG-based neonatal seizure detection algorithm was developed, improved and validated by authors in [58, 59].

Some of the listed studies are related to the neonatal intensive care unit, as there neonatal seizures commonly occur. Anyway, there is no commercially available multi-channel EEG-based neonatal seizure detection algorithm that is widely accepted for clinical use [59].

3.3. Neonatal EEG sleep analysis

Sleep in adults is significantly different than sleep in newborns, as already mentioned in Chapter 2. There are fundamental differences in sleep architecture, continuity, phasic activities and EEG patterns. Unlike in the adults, in full-term newborn, sleep cycles last approximately 60 minutes. A newborn sleeps 16-20 hours per day. Comparatively less attention has been directed to automated analysis of neonatal sleep EEG recordings than to automated analysis of sleep EEG in adults.

Classification of sleep stages in newborns was addressed in several published papers in the last decades, most of them coauthored by Mark S. Scher. In [60, 61] comparison of sleep states was made between healthy preterm and full-term infants. The analysis included extraction of only spectral features from constant one minute length EEG segments. The same problem was addressed in [62] where authors used 7 features to describe differences in EEG sleep behaviors, only 2 were quantitative features, others were determined visually or derived from non-EEG channels. In [63], 45 EEG-sleep measures were used, but only 6 of them were spectral features derived from EEG channels. Finally, another research group around G. B. Boylan addressed the problem of neonatal sleep classification, e.g. in [64], making the comparison by using three features which were pre-chosen according to their application in EEG studies in adults, in other applications in the field on neonatal neurology and theoretical assumptions.

Authors in [65, 66] proposed methodology for separation of two sleep stages in neonates using polysomnographic recordings. Extracted features included only spectral EEG features and features derived from other recorded signals. Using a single EEG channel, in [67, 68] authors addressed sleep stages separation. Presented algorithms included extraction of spectral and nonlinear features, and time frequency analysis followed by computation of Shannon entropy, respectively. Following the work presented in [67], a larger selection of EEG channels was addressed in [69]. As a result, selection of EEG channels and characteristics that are suitable for EEG sleep separation in newborns was reported. Furthermore, [70] used a single nonlinear feature (dimensional complexity) to explore the complexity of the EEG time series during stages of neonatal sleep. Authors in [71] addressed the application of the EEG temporal profiles, created by adaptive segmentation and cluster analysis, for the quantification and for detection of sleep changes.

Wavelet transform based features are rarely used in analysis of neonatal sleep recordings, for example [72]. Also, in [73] wavelet transform based feature was used for detection of trace alternant.

3.4. Application of approximate entropy

Nonlinear methods are widely used for examination of nonlinear systems. Various publications showed results which confirm that nonlinear measures, such as approximate entropy, sample entropy, correlation dimension, Lyapunov exponent, are suitable for addressing many problems in biomedical engineering. Approximate entropy (ApEn) is a relatively recently developed statistic quantifying regularity and complexity, which has found application to a wide variety of physiological and clinical time-series data [74]. The development of ApEn was motivated by data length constraints commonly encountered, for example, in heart rate, EEG, endocrine hormone secretion datasets [75].

In the literature review, it can be seen that approximate entropy is not the only entropy based feature used in the EEG/PSG studies. Changes in the behavioral states are reflected in the changes of EEG, which is expected to be noticed in the change of entropy results (values of entropy based features). Entropy features that are the most commonly used are, besides ApEn, Shannon entropy and sample entropy. In [76], detrended fluctuation analysis was also used, although it is not a true entropy estimator, but it was still computed together with entropy values as it is a measure that allows the detection of long-range power-law correlations in a time series [77].

Approximate entropy is considered to be one of the most successful non-linear methods and has been used in the literature to analyze various signals in biomedical engineering. There are numerous studies that apply approximate entropy on, for example, heart rate variability [78, 79], prediction of survival in heart failure [80], problems in prediction of atrial fibrillation termination [81] or aging and the complexity of cardiovascular dynamics [82].

There are also studies that apply approximate entropy on the electroencephalogram. The automatic detection and identification of EEG waves play an important role in the prediction diagnosis and treatment of epileptic seizures. Results indicating that approximate entropy is suitable to characterize the dynamic changes during seizures and support seizure prediction are reported, for example, in [83, 84, 85, 86]. Approximate entropy has been also used in other various EEG based applications, e.g. in estimation of anesthesia depth [87] or in classification of sleep stages in adults [88]. Moreover, in [89, 90], the author proposed methods for detection of epileptic seizures based on the decomposition of EEG into sub-bands using discrete wavelet transform and complexity analysis of these sub-bands using approximate entropy. Proposed schemes were tested using clinical single channel EEG data recorded from five healthy subjects and five epileptic patients. It was shown that the proposed schemes were able to detect epileptic seizures with high accuracy. Thus approximate entropy was proven in the literature to be an effective analysis tool not only for detecting seizures but also for understanding EEG dynamics. Application of approximate entropy of EEG signal was reported also in [91]. This study was undertaken to identify the best performing quantitative EEG

features for neonatal seizure detection. According to reported results, combination of extracted features yielded to the highest classification accuracy.

3.5. Application of Hurst exponent

Hurst exponent was introduced and developed in hydrology. It was introduced by H. E. Hurst, in the middle of 20th century, as a way to model the levels of the river Nile [92]. Hurst exponent is directly related to the fractal dimension - a small value of Hurst exponent indicates a higher fractal dimension and vice versa. Nonlinear parameters, such as Hurst exponent, are used to extract relevant information from physiological signals. Hurst exponent found application in biomedical engineering, but also in other nonrelated fields such as finance, in connection with financial markets, or ecology, where it is used to model populations. As Hurst exponent is used in the literature to analyze various biomedical signals, there are studies that apply this exponent on, for example, detection of sleep apnea from electrocardiogram [93] or cardiac response to positive and negative emotional stimuli [94].

It has been found that EEG signal can be characterized by the Hurst parameter [95, 96, 97]. Among other nonlinear features, Hurst exponent was used in the study related to the classification of sleep stages in adults [88], based on the sleep EEG recordings of adults from the Sleep-EDF Database available from the Physionet (PhysioBank), a data resource. Most of the research in the field of EEG analysis focuses mainly on detection/classification of epileptic activity. In [98], the authors tested the classification ability of the Hurst exponent for epileptic seizure recognition. Detection of epileptic seizures was assessed also in [99, 100] where the Hurst exponent has been used as feature extracted from epileptic EEG. Using surrogate data analysis, in [101] the authors shown that the Hurst exponent is useful to characterize a normal and epileptic brain activity. Regarding sleep studies, in [102] the transition process between NREM and REM stages was addressed, and it was found that the Hurst exponent can be used as an indicator of the transitions. The distribution of the EEG bursts in very preterm neonates through two estimates of the Hurst exponent was addressed in [103].

3.6. Automated EEG analysis

The aim of automated methods for EEG/PSG data analysis is to support the evaluation of neurologists with objective data in numerical or graphical form. It is very difficult to develop fully automated methods that would approximate evaluation of medical doctors and correctly evaluate various EEG patterns or states. There are several software packages and toolboxes that can be used for EEG/PSG signal analysis, each one of them has its own specificities and advantages. Examples include EEGLab software package [104], LORETA [105], ASA cognitive software [106], as well as BioSig open-source software tool for biomedical signal processing [107], and BrainStorm software [108].

EEGLab is a Matlab toolbox for processing continuous and event-related EEG, MEG and other electrophysiological data. It provides graphic user interface, and incorporates independent component analysis, time/frequency analysis, artifact rejection, event-related statistics, and several visualization modes. LORETA software can be used for estimating the electric neuronal activity distribution based on the non-invasive scalp measurements of electric potential differences as well as magnetic field measurements (MEG) and is used in clinical studies. BioSig is an open source software library for processing biomedical signals, such as EEG, electrocorticogram, ECG, EOG, EMG and respiration. It provides solutions for data acquisition, artifact processing, quality control, feature extraction, classification, modeling and data visualization. Several pattern recognition toolboxes for Matlab are also available, e.g. PRTools [109]. PRTools includes procedures for data generation, training classifiers, combining classifiers, feature selection, linear and nonlinear feature extraction, cluster analysis, evaluation and visualization.

Chapter 4

Stages in EEG signal processing

4.1. Typical stages in EEG signal processing

By its nature, EEG signal is the most complex signal that can be measured on human body. Processing of this kind of signal presents a complex process. Still, the majority of clinical EEG/PSG recordings are evaluated visually by medical doctors, as already stated in the previous chapters.

The field of computer assisted processing of this type of data is very popular, and its importance is recognized. This field is multidisciplinary, both technical and medical. Still, there is a need to further develop and enhance existing automated systems in order to introduce them into the everyday clinical practice. Processing of EEG/PSG recordings represents a complex multilevel procedure, consisting of several stages. This procedure is gaining in importance when dealing with long-term recordings. Main stages in the processing process are [110]:

- preprocessing,
- data representation, and
- classification.

Each of these stages encompasses several mandatory or optional substeps, whose parameters may be adjusted and optimized. Figure 4.1 presents a generalized block diagram of stages in the processing of EEG/PSG recordings. This comprehensive methodology can be used on various types of EEG/PSG recordings, e.g. long-term sleep recordings (in adults or in neonates), comatose recordings, epileptic recordings, as well as on large or small, clinical or artificially generated datasets.

In this Chapter, processing steps depicted in Figure 4.1 will be described in detail. It is important to understand relationship between individual steps and substeps, and their mutual influence. It is also important to understand process of multichannel signal processing as a whole in order to be able to focus research and development on its specific parts.

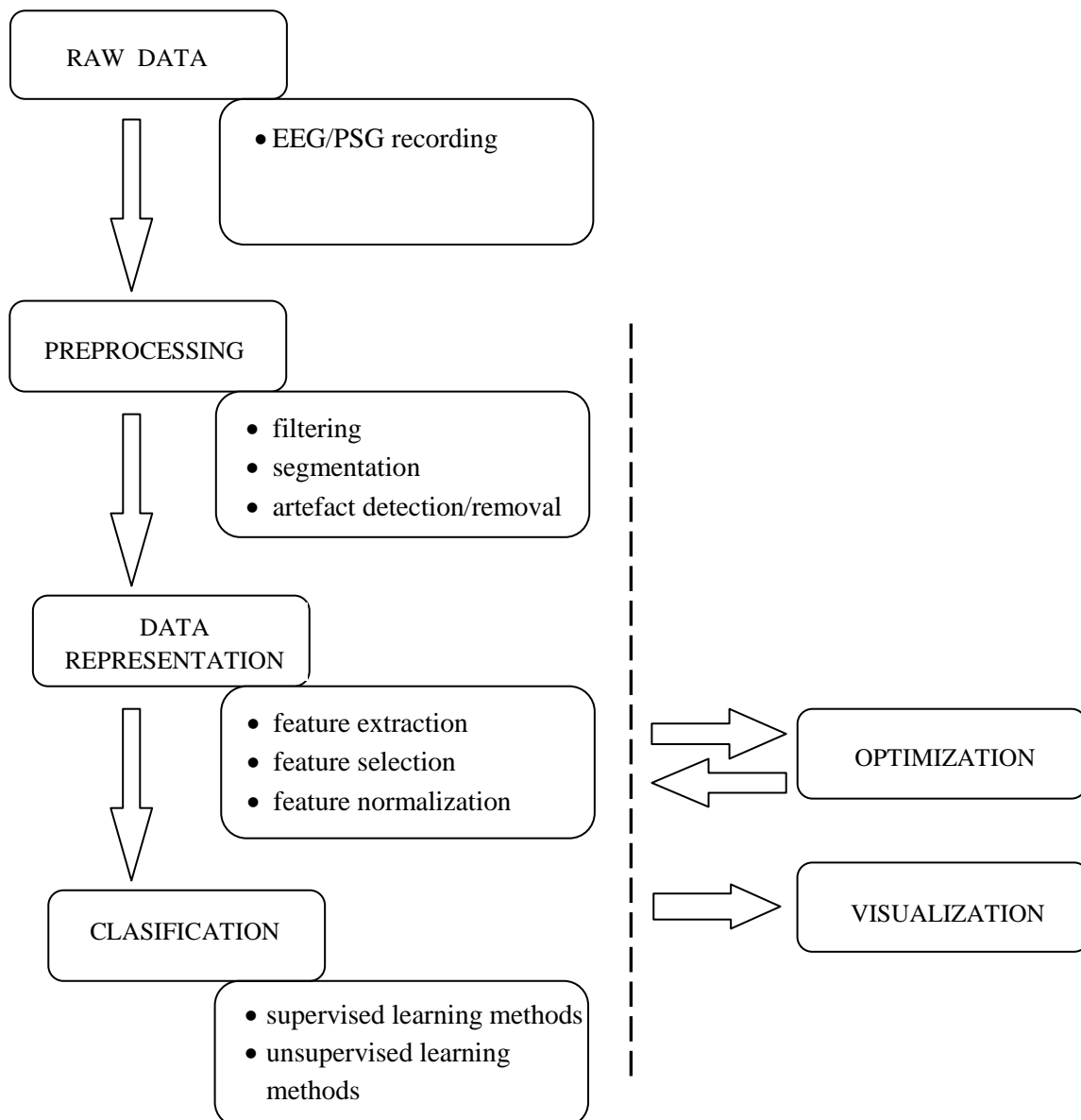

Figure 4.1: Block diagram of typical stages in EEG/PSG signal processing.

4.2. Preprocessing

Usually processing of the nonstationary, complex signals starts with preprocessing. Preprocessing usually implies filtering, segmentation and artifact detection/removal, but and it may include signal resampling, baseline wandering removal and various EEG averaging techniques as well.

Due to the 50Hz power supply interference, notch filters may be are used. The use of IIR (Infinite Impulse Response) notch filters is usual, however it can produce a substantial distortion of the output response due to the group delay variation [65]. Since the useful information in EEG signals in many applications lies below 30Hz, frequency components above these frequencies can be removed by using standard low-pass or

band-pass FIR or IIR filters. The choice of filter can influence the quality of filtered signal that will be further processed.

EEG signal, and other PSG signals in general, naturally contain various artifacts that may occur at any point during the recording process. One of the simple methods with satisfactory artifact detection success rate is described for example in [111, 25]. This method marks signal segments with amplitudes higher than the threshold as artifact segments. The threshold value can be set as a predefined constant value or obtained adaptively, e.g. based on the standard deviation of observed signal. Other various techniques for automatic detection and/or elimination of EEG artifacts have been reported, e.g. [112, 113]. Standard FIR and IIR filters, adaptive filters, regression methods (both in time and frequency domain) and methods like Principal Component Analysis, Independent Component Analysis and various hybrid methods are also used.

4.2.1. Segmentation

Like most of the real signals, EEG signals are non-stationary. As their statistical characteristics may vary in time, spectral analysis or other similar techniques cannot be directly applied to the signal – it is first necessary to divide the signal into stationary (or quasi-stationary) segments whose statistical parameters are constant. This is a main idea of signal segmentation.

In principle, there are two basic approaches to signal segmentation: constant and adaptive segmentation. Constant segmentation divides signal into segments of constant, predefined length. Obtained segments may overlap. On the other hand, algorithm of adaptive segmentation, e.g. [71, 114], divides the signal into quasi-stationary segments of variable length. The reason for the introduction of such algorithm is that the subsequent feature extraction from relatively homogenous segments would be substantially more effective than the feature extraction from segments of constant length. This method can be also used for computing segment boundaries in other recorded polysomnographic channels independently, not just for EEG. Figure 4.2 illustrates results of segmentation, both constant and adaptive, applied to part of newborn polysomnographic recording. The PSG recording in Figure 4.2 is a part of the dataset that will be introduced in Chapter 6.

4.3. Data representation

After signal preprocessing, information needed for classification are extracted. Thus each EEG signal segment is represented by a set of parameters (features). Feature extraction can be followed by normalization of computed features, dimensionality reduction, and/or feature selection.

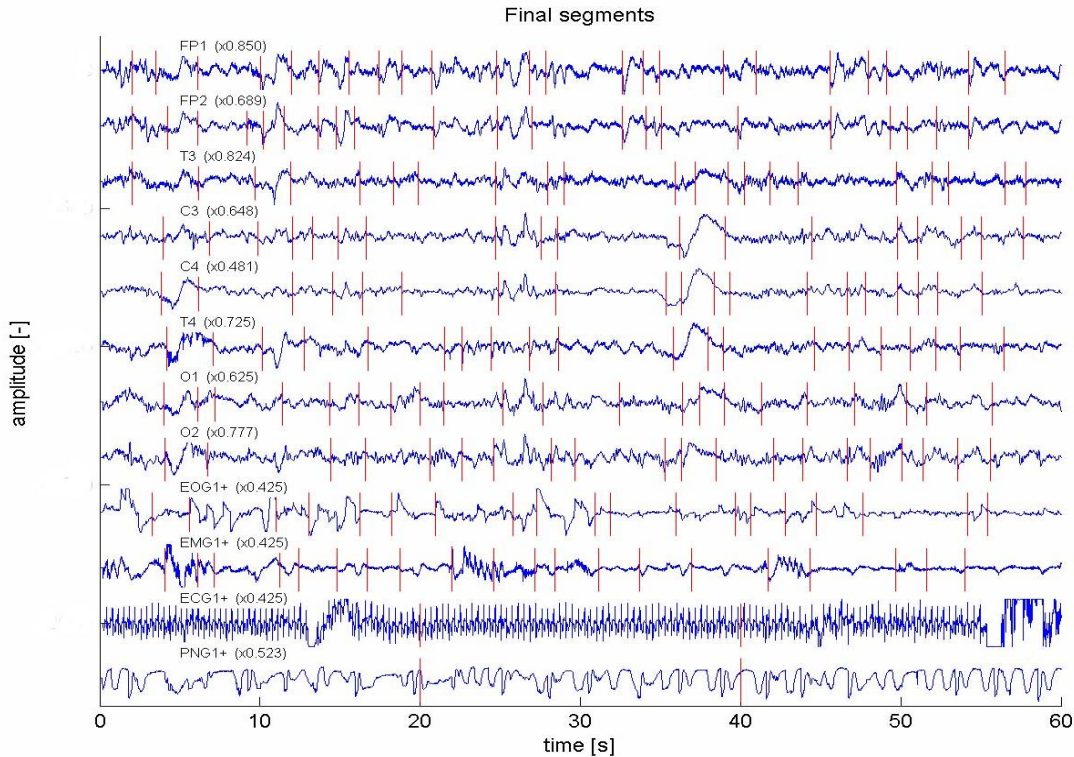

Figure 4.2: Final segmentation results of 60s of newborn PSG recording: adaptive segmentation was applied to EEG, EOG and EMG channels, while ECG and PNG channels were segmented to segments of constant length.

Due to personal intervariabilities which are present in EEG signals, individual features may differ in several orders of magnitude. In order to avoid possible problems caused by the inadequately scaled features, the normalization may be performed. This way, the comparable mean and variance are achieved.

With feature extraction from EEG, or generally from any other of PSG signals, several hundreds of features can be acquired. This may represent a burden for further processing. Often not all of the computed features are necessary for providing good discrimination. There are different ways in which the dimensionality of a problem can be reduced. One of them is the use of principal component analysis (PCA) [115], often found in the literature.

The dimensionality of the feature space may be reduced by the selection of subsets of features. Various strategies and criteria are developed for searching useful subsets of relevant features from the initial set of features. Feature selection is important because it decreases the amount of features that have to be measured and processed, and also can increase the classification accuracy. In other words, feature selection is considered to be successful if the dimensionality of the data is reduced and the classification accuracy improves or remains the same. Several feature selection algorithms are implemented for example in PRTTools, a Matlab toolbox for pattern recognition [109].

Feature extraction is a significant step in the computational data processing. It can be defined as automated recognition of various descriptive features of signals. Each

segment obtained by signal segmentation can be represented by its extracted features – feature vectors. A good feature should remain unchanged if variations take place within a class, and it should reveal important differences when discriminating between patterns of different classes.

The set of utilized/extracted features varies. In many publications, power spectral density features calculated for typical EEG frequency bands, based on the Fourier transform, are used, and it is proven to be effective in various fields of applications. Less attention was focused on utilization of features after the application of other mathematical transforms, e.g. wavelet transform, to biological signals. A brief overview of wavelet transform will be given in the subsection 4.3.1. Various features may be extracted from EEG/PSG signals after the application of this transform. Features may be computed for every approximation and detail obtained after the application of wavelet transform. In EEG signal processing, wavelet decomposition is conducted in the way that wavelet coefficients correspond to important EEG frequency bands.

4.3.1. Wavelet transform – brief overview

Wavelet transform (WT) is used for a time-frequency analysis. It is capable of distinguishing very small and delicate differences between time-varying signals even from their short segments, and may describe highly irregular and nonstationary signals. WT analyzes the signal at different frequencies with different resolutions. Thus, it gives precise frequency information a low frequencies and precise time information at high frequencies.

The continuous wavelet transform (CWT) of a signal $x(t)$, is the integral of the signal multiplied by scaled and shifted versions of a wavelet function ψ and is defined by

$$CWT(a, b) = \int_{-\infty}^{\infty} x(t) \frac{1}{\sqrt{|a|}} \psi\left(\frac{t-b}{a}\right) dt ,$$

where a and b are scaling and time localization or shifting parameters, respectively [90]. Calculating wavelet coefficients at every possible scale is computationally very expensive task. Instead, the parameters a , b may defined in such a way that $a=2^j$ and $b=2^j k$ (dyadic scales and positions). Such analysis is obtained from discrete wavelet transform (DWT) which can be defined as

$$DWT(j, k) = \frac{1}{\sqrt{|2^j|}} \int_{-\infty}^{\infty} x(t) \psi\left(\frac{t-2^j k}{2^j}\right) dt .$$

Discrete wavelet transform is used to process digital signals.

The multiresolution analysis (MRA) is important part of the wavelet theory. The idea of MRA was developed by Mallat and Meyer, and according to it the signal is subsequently being decomposed into details and approximations. In [116], the author presented developed methodology for implementing this scheme by passing the signal through a series of low-pass (LP) and high-pass (HP) filter pairs named quadrature mirror filters. In practical applications also, filter bank (quadrature mirror filters) and Mallat's algorithm for discrete wavelet transform are usually used. As outputs of the

low pass filters approximations are obtained, while details represent outputs of the high pass filters.

In the first step of DWT, the signal is simultaneously passed through a LP and HP filters with the cut-off frequency being the one fourth of the sampling frequency. The outputs from the low and high pass filters are referred to as approximation (A_1) and detail (D_1) coefficient of the first level, respectively. To get second level approximation and detail coefficients, the same procedure is repeated for the first level approximation. This procedure may be continued, and at each step of the decomposition process, the frequency resolution is doubled and time resolution is halved through downsampling. Figure 4.3 illustrates the third level wavelet decomposition of a signal.

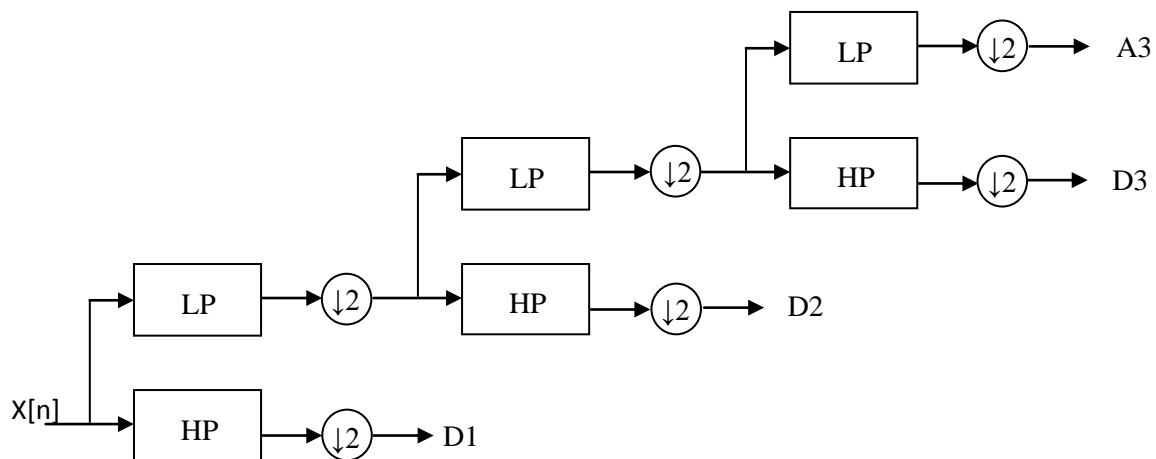

Figure 4.3: Third level wavelet decomposition of a signal. The coefficients D_1 , D_2 , D_3 and A_3 represent the frequency content of the original signal within the bands $fs/4 - fs/2$, $fs/8 - fs/4$, $fs/16 - fs/8$ and $<fs/16$, respectively, where fs is the sampling frequency of the original signal $x[n]$.

The original signal is successively decomposed into components of lower resolution, while the high frequency components are not analyzed any further. The maximum number of decompositions that can be performed is dependent on the input size of the data to be analyzed. With 2^N data samples, it is possible to breakdown the signal into N discrete levels using the DWT. In practical applications, a smaller value than the maximally allowed level of decomposition is chosen. Also, this maximal allowed level of decomposition depends on the choice of wavelet function.

Wavelet packet analysis is a generalization of wavelet decomposition that offers a richer range of possibilities for signal analysis and significantly increases the versatility and power of the DWT. The decomposition of details as well as approximations is the main idea of the wavelet packet approach [117]. Unlike the DWT which only decomposes the low frequency components (approximations), wavelet packet analysis utilizes both the low frequency components, and the high frequency components (details), meaning that the details as well as the approximations can be split and used.

As already mentioned, Fourier transform is used as a basis for the computation of features usually applied in the EEG signal processing, for various fields of applications. This way, signals are characterized in the frequency domain. Besides frequency domain,

signals are usually characterized in the time domain. By application of wavelet transform signals are characterized in the time-frequency domain.

Signal decomposition into frequency components is a basis technique in the analysis of EEG signal. It is important to point out that with this approach time information is lost and only frequency components of signal are provided. The power as a function of frequency, power spectral frequency, could be estimated by Fourier transform (FT). Thus the basic signal transform from time domain to frequency domain in the field of EEG signal analysis is Fourier transform. This transform, including discrete, discrete time and short time Fourier transform, and algorithms for their computation can easily be found in the literature, e.g. [118, 119]. Actually, the introduction of the fast Fourier transform (FFT) algorithm made the wide application of FT possible. Figure 4.4 a) shows how short time Fourier transform (STFT) divides the time-frequency space [120]. It should be mentioned that the attention must be given to the choice of the time window length. For instance, when analyzing a signal by using a large window, the frequencies cannot be sufficiently resolved in time. Conversely, using a small window a fine time resolution is possible, however low frequency components can no longer be measured.

Unlike the STFT, WT-based methods can better localize the signal components in time-frequency space. Figure 4.4 b) shows division of time-frequency space for WT.

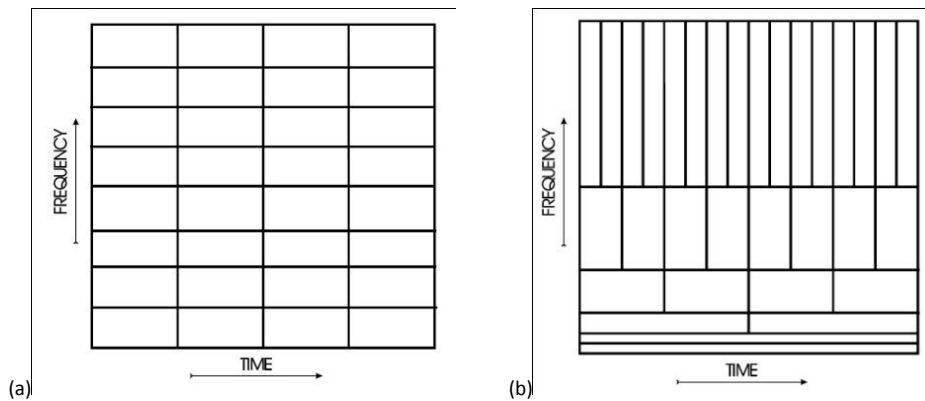

Figure 4.4: Symbolic division of time-frequency space for (a) STFT and (b) WT.

More information and details about wavelet transform can be found in the literature, e.g. [121, 122, 123].

4.4. Classification

Generally speaking, classification involves assigning a class to an unknown object. Classification is considered to be a learning task of finding a function that maps feature space X to class labels Y as follows: $f : X \rightarrow Y$. The f should generalize well on unseen data.

In the case of EEG signal processing, objects that need to be classified are segments described by vectors of features. For obtaining final results of analysis, both supervised and unsupervised classification methods are used. Supervised learning uses training set for training the classifier. This results into very large dependency of the classifier on the training set and might have problems with special cases not included in the training set. On the other hand, unsupervised classification methods are using only information contained in the data, no additional information (in the form of class membership or training set) is provided. Clustering is one of unsupervised classification methods.

Algorithms that are often used for classification of EEG signals are K nearest neighbor classifier Naive Bayes, Decision tree classifier, artificial neural networks, Hidden Markov Models, and Support vector machines. The focus of this thesis is not on the classification stage, nor on the creation of a new classifier. Thus we used Naive Bayes, chosen due to its simplicity and wide application in the various fields. Also, this way we could leave the focus on the data representation stage: obtained classification results were not influenced or increased by the use of different classifiers, or combination of classifiers, but based on the potential of extracted feature. More information about Naive Bayes method for supervised learning is given in subsection 4.4.1.

4.4.1. Naive Bayes classifier

The Naive Bayes classifier is a popular learning algorithm for data mining applications. It is an algorithm that applies Bayesian probability theory to the classification of data based on an automatically constructed statistical probability model. According to the Bayes theorem, posterior probability is computed as

$$p(Y|X_1, \dots, X_d) = \frac{p(Y)p(X_1, \dots, X_d|Y)}{p(X_1, \dots, X_d)}$$

where Y is the class variable and X_1, \dots, X_d are features. The Naive Bayes uses this theorem but with strong (naive) assumption that features are conditionally independent given the class. Therefore, posterior probability can be estimated as

$$p(Y|X_1, \dots, X_d) = \frac{p(Y)}{p(X_1, \dots, X_d)} \prod_{i=1}^d p(X_i|Y)$$

To minimize error classification, the decision rule with maximum posterior probability, is chosen

$$Y_{map} = \arg \max_y p(Y = y) \prod_{i=1}^d p(X_i = x|Y = y)$$

More information about classifiers can be found in, for example, [124].

4.5. Optimization and visualization

Appropriate parameter values can be set in each processing stage. Setting these values is often a subject for optimization, and the choice influences the results of the analysis/classification. In certain cases, parameters are set by the trial and error.

Visualization may also be considered as a stage in the EEG/PSG signal processing. Visualization of data, signal processing steps and their intermediate results gives the possibility of understanding the results easier, and also it gives the connection between the obtained results and their interpretation. Visualization methods can ease the work of medical doctors and show trends that are not obvious when performing visual inspection of the recorded signals.

4.6. Assessment of classification performance

Performance evaluation is an important part of biomedical signal processing. The most common form to represent performance is by a confusion matrix, presented in Table 4.1. True negative (TN) expresses number of correctly classified negative examples, true positive (TP) is number of correctly classified positive examples, false negative (FN) is a number of incorrectly classified negative examples, and false positive (FP) is the number of incorrectly classified positive examples.

Table 4.1: Confusion matrix, p/n – actual positive/negative, p'/n' - predicted positive/negative.

	p'	n'
p	TP	FP
n	FN	TN

Based on TP, TN, FP and FN measures, parameters that are frequently used to determine the classifiers performance are sensitivity, specificity, selectivity, precision or positive predictive value, average detection rate and overall classification accuracy. Sensitivity and specificity represent the accuracy observed separately on positive and on negative examples, respectively. Sensitivity (SEN) and specificity (SPE) are computed as:

$$SEN = \frac{TP}{TP + FN},$$

$$SPE = \frac{TN}{TN + FP}.$$

The overall classification accuracy (Acc) can be computed as:

$$Acc = \frac{TP + TN}{TP + FP + FN + TN}.$$

Chapter 5

System realization

This Chapter will introduce software tool (Polysomnographic Data Processing Toolbox – PSGlab) used for the realization of computer-assisted analysis of newborn data, developing of specific approaches and for obtaining results presented in this thesis. Also, selected details of the automated processing process and methods enabled by this toolbox will be presented, and some of the previous applications will be listed. PSGlab implements generalized multilevel EEG/PSG evaluation process, presented and explained in the previous Chapter 4.

5.1. PSGlab

PSGlab toolbox is a Matlab toolbox that has been developed for automated processing of polysomnographic recordings, or other multichannel biomedical data [125, 126]. It was developed within BioDat research group, Department of Cybernetics, Faculty of Electrical Engineering, Czech Technical University in Prague [127]. The motivation and the goal for the development of such toolbox were to obtain a universal tool for processing of EEG/PSG recordings in the various fields of their application, and evaluation of certain specific topics in the analysis of complex multichannel data. The goal of the realization of PSGlab is also to facilitate the work of medical doctors and to increase objectivity of data evaluation. PSGlab has been tested on real clinical PSG recordings. Fields of its application encompass sleep studies in adults and newborns, epileptic studies, analysis of comatose recordings, as well analysis of non-clinical data, e.g. recordings obtained during emotional tasks as a part of cognitive studies.

Regarding data import and export formats, PSGlab includes a multiformat data importing tool, e.g. for EaSys and ASCII formats. The raw biomedical signals are read from the appropriate data format and stored as a mat file. Information about the processed PSG recordings (e.g. the names of the electrodes, the number of channels, the number of samples, sample frequency) are exported to xml file. In addition, text files may be created for various information, e.g. for information about segments' position, names and values of extracted features, results of different analyses various intermediate and final results, etc. Files may be exported as arff files, which is important for connection with Weka software and subsequent classification. Graphs or images can be exported to various file formats, e.g. tiff, png or Matlab fig.

PSGlab uses additional definition files. These files may include various information about the used dataset or applied methods. They comprise, for example, names of the classes, selection and definition of channels, definition of frequency bands, coordinates for visualization. Besides additional definition files, PSGlab enables some of the settings to be configured locally at the toolbox (a list of files selected for the certain operation, together with their parameters).

The structure of PSGlab is modular. This toolbox is realized with this kind of open structure in order to allow that various changes can be easily implemented and tested.

Also, some of the other features of PSGlab include the possibility of interconnection with other software tools, like EEGLab [104], Weka software [128] and PRTools [109]. For example, export of the final representation of EEG/PSG recordings from PSGlab in the appropriate file format for Weka is enabled.

5.2. Methods implemented in PSGlab

PSGlab implements EEG/PSG signal processing stages, as introduced in Chapter 4, namely signal preprocessing, data representation, and classification. This way, PSGlab enables important information hidden in biomedical signals to be extracted, processed and suitably interpreted and presented.

The signal preprocessing stage available in PSGlab includes various methods:

- filtering: notch filter and FIR filters are implemented. Notch filter can be applied for 50/60 Hz filtering, while FIR filters are usually used for separating individual EEG frequency bands,
- resampling;
- isoline removal;
- signal averaging: this method can be used, for example, over predefined electrodes in order to achieve data reduction;
- joining of recordings in different formats: this method is applied, for example, after simultaneous measurement of biomedical signals using different methods);
- verification of the consistency of the input data and expert's classification, if expert's classification is available;
- artifact detection: a method for muscular artifact detection is implemented;
- segmentation: constant and adaptive segmentation algorithms are implemented. Within the same PSG recordings, channels can be segmented with application of different segmentation algorithms. The implemented adaptive segmentation approach is based on the use two connected windows of the same length, sliding along the signal. The border of each segment is indicated by the local maxima of the difference of the signal parameters in the two windows (the combined amplitude and frequency difference was taken for the difference measure).

Regarding the data representation stage, PSGlab implements following algorithms:

- feature extraction;

- feature normalization: Due to variability that may exist in EEG signals in different persons, individual features may differ by several orders of magnitude. The normalization algorithm is performed in order to avoid possible problems caused by the inadequately scaled features, and to obtain comparable mean and variance.
- feature selection: besides feature selection in PSGlab, it is also enabled that data are exported in the appropriate form for the application of PRTools.

Different classification methods are implemented in PSGlab, related to the supervised and unsupervised learning. Regarding the unsupervised learning, special attention was given to hierarchical clustering. In order to provide classification with the wider variety of classification methods, as already mentioned, interconnection with Weka software tool is enabled.

Besides the listed stages, it should be mentioned that PSGlab provides a tool for the visualization of obtained results. For example, PSGlab includes 2D topographical visualization, time-sequence maps for basic EEG frequency bands and spectrogram normalization method.

5.2.1. Information extraction

Extraction and identification of informative features of PSG signals are important part of the data representation stage. This subsection will give the overview of the features that can be extracted with PSGlab toolbox.

Besides the computation of the set of the most commonly used features in the EEG signal analysis, namely statistical features and power spectra in basic EEG frequency bands, PSGlab enables computation of wide variety of features, from different domains. A list of PSGlab features is given in Table 5.1. This comprehensive list of features was obtained after the research of the available literature. More information about features can be found in the in [65, 91, 129, 57, 130, 131]. Also, the implementation of feature extraction in PSGlab was done mainly in accordance with these publications.

This thesis focuses on the application of two features, approximate entropy and Hurst exponent. It can be seen that these features are just two from the wide set of possible PSGlab features. Extensive research was conducted regarding the use of various individual features, as well as their combinations, their possibility to extract relevant information and to be a part of a set of non-redundant features. This kind of research was done with different available clinical recordings, meaning in different fields of EEG application. Based on the obtained results, potential for the use of the approximate entropy and Hurst exponent in the field of sleep EEG in newborns was noticed. Consequently, special attention was focused on their application. Thus approximate entropy and Hurst exponent were not selected randomly, but based on the results obtained throughout research and testing, and characteristics of the EEG signal.

Table 5.1. Features that can be extracted with PSGlab toolbox.

Analysis	Features
Time domain or Wavelet transform	Statistical features (minimum, maximum, mean, median, standard deviation, skewness, kurtosis) 1 st derivative (max and mean absolute value) 2 nd derivative (max and mean absolute value) Zero crossing rate Coefficient of variation
Time domain	Line length Root mean squared (RMS) value Nonlinear energy Mobility (2 nd Hjorth parameter) Complexity (3 rd Hjorth parameter) Number of local minima/maxima Amplitude range Mean and variance of vertex-to-vertex amplitude Mean and variance of vertex-to-vertex time Mean and variance of vertex-to-vertex slope
Frequency domain	Absolute and relative power for: delta, theta, alpha, beta, and gamma frequency band Total spectral power Power ratio in frequency domain Spectral edge frequency Spectral roll-off
Wavelet transform	Wavelet energy and energy percent for: delta, theta, alpha, beta, and gamma frequency band Total energy Energy ratios
Other	Shannon entropy Spectral entropy Approximate entropy Sample entropy Hurst exponent Brain symmetry index (BSI) and BSI-like features

5.3. Applications

PSGlab toolbox, or its previous parts and versions, was already used in the research and development. Results of the studies, conducted with the use of this toolbox, are already published, for example in [72, 129, 132, 133, 134]. Although it is not directly related to this thesis, it should be mentioned that PSGlab is used in the educational purposes, and for the creation of teaching material [135].

PSGlab was used in the course of preparation of this thesis. In subsequent Chapters 7 and 8, specific realization of the applied systems for approximate entropy-based distinction of sleep stages and analysis based on Hurst exponent will be presented. Results that will be presented were obtained with this toolbox.

Chapter 6

Dataset

This Chapter provides information about available clinical polysomnographic recordings and used dataset.

Clinical recordings were provided by The Institute for Care of Mother and Child in Prague, Czech Republic. Polysomnographic recordings of 22 healthy full-term neonates, at 40 weeks gestational age, were selected from a wider study by the medical expert. Recording was made with EDAS 220 Brainscope system. The EEG activity was recorded by eight channels positioned under the international 10-20 standard, namely Fp1, Fp2, C3, C4, T3, T4, O1, and O2. Referential montage was used. The sampling frequency for all measured channels was 128Hz. Other recorded polygraphic signals were: electrooculogram (EOG), electromyogram (EMG), electrocardiogram (ECG) and respiration (PNG). EOG was recorded by two electrodes, the first one placed slightly above and to the outside of the right eye and the second placed below and to the outside of the left eye. Two EMG electrodes were placed close to the left corner of the mouth and on the chin. ECG was recorded using two electrodes, one placed over the sternum and the other one in the medial axillary line. The respiratory effort was measured using a tensometer placed on the abdomen.

Figure 6.1 illustrates examples of clinical PSG recording of a newborn during different sleep stages [65].

All available PSG recordings were annotated by experienced neurologist. For each subject, medical expert selected artifact-free segments of recordings corresponding to quiet and active sleep stages, not including onset of these states.

This dissertation addresses the problem of analysis of electroencephalographic signals from polysomnographic recordings. Thus only EEG channels were selected and used in the analysis based on Hurst exponent and approximate-entropy based distinction of sleep stages.

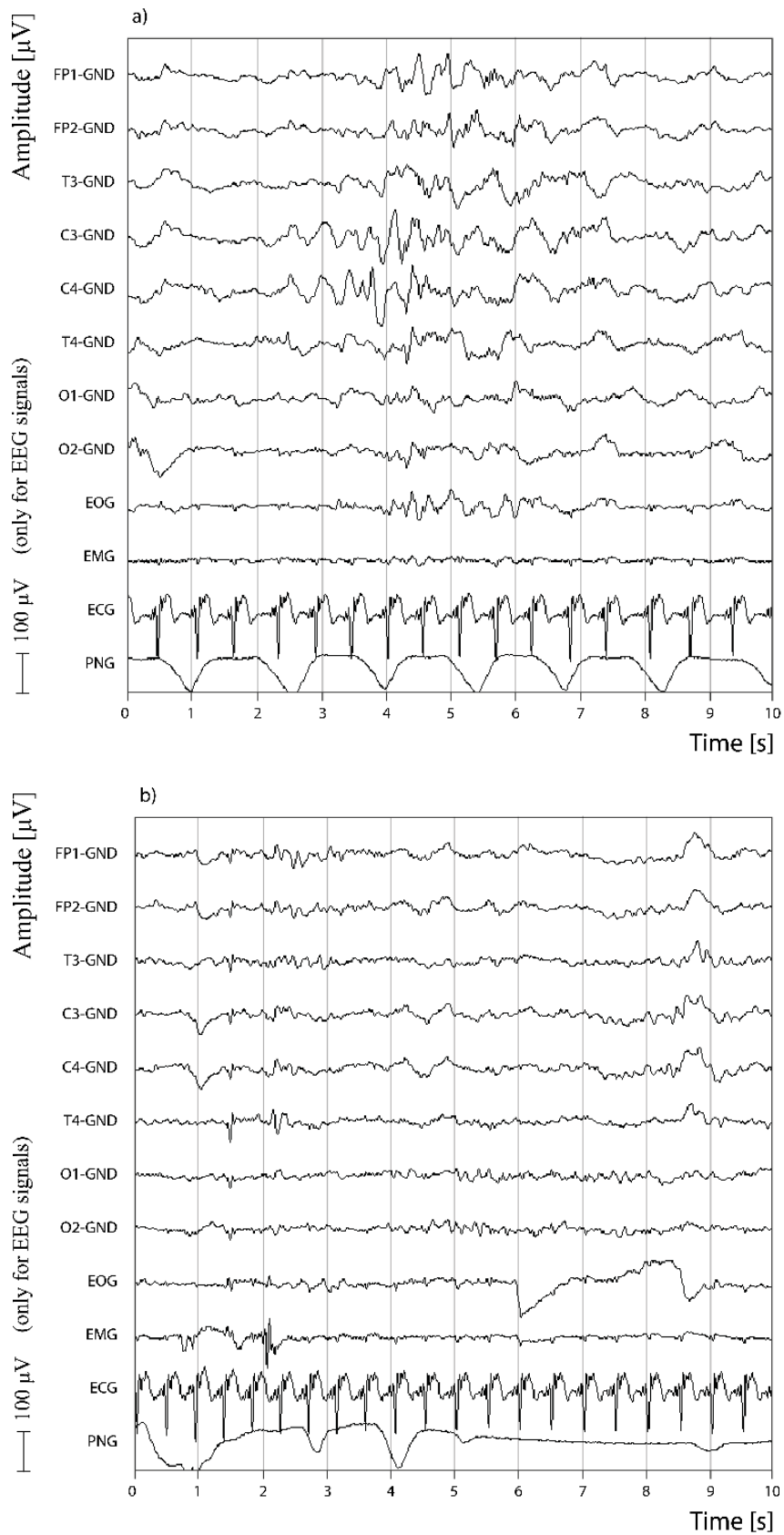

Figure 6.1: Examples of PSG recording of a newborn during (a) quiet and (b) active sleep stage. Eight EEG channels, respiration, EOG, ECG and EMG are displayed. Time frame in both cases is 16s.

It should be noted that publicly accessible database, or available dataset, of preterm or full-term newborn PSG/EEG recordings do not exist. The lack of such database, with larger number of recordings, can be considered as one of the main obstacles for improvement in the field of neonatal signal analysis.

Chapter 7

Approximate entropy-based sleep staging

Approximate entropy is a measure that quantifies the regularity or predictability of a time series. It takes into account the temporal order of points in a time sequence and is a measure of randomness or regularity. In this Chapter, the application of ApEn for the discrimination of quiet and active sleep stages in full-term neonates will be presented, and obtained results will be given and further discussed. Prior to that, the short overview of theoretical background for the calculation of entropy based features, with focus on approximate entropy will be given, followed by the description of individual steps of the implemented system.

7.1. Theoretical background

Nonlinear methods have proven their usefulness in the analysis of EEG/PSG recordings. The most frequently used entropy based features are Shannon entropy, spectral entropy, approximate entropy and sample entropy. Entropy describes behavior of a system in terms of randomness and quantifies information about the underlying dynamics. A stochastic, irregular, and less predictable signal has higher entropy than a completely deterministic one.

Entropy based features cannot be estimated by visual analysis. Thus these features can provide additional information about investigated signals in existing everyday clinical practice and possibly point out characteristics that are not obvious but may have clinical relevance.

Entropy introduced by Shannon, may be interpreted as the measure of impurity of a signal [136, 137]. If X denotes signal/EEG epoch, using a histogram estimate of the probability density function, $P_h(X)$ to Shannon's channel entropy formula yields an estimate of the Shannon entropy (H_{SH}):

$$H_{SH}(X) = -\sum_f P_h(X) \ln P_h(X).$$

Spectral entropy H_S can be calculated by using the following equation, which normalizes H_S to the range 0-1:

$$H_S(X) = -\frac{1}{\log N_f} \sum_f P_f(X) \ln P_f(X) ,$$

where $P_f(X)$ is an estimate of the probability density function for the signal/EEG epoch X , and is calculated by normalizing the power spectral density estimate with respect to the total spectral power [91]. The PSD is calculated in the frequency range $[f_l, f_h]$ for each epoch, and boundary frequencies differ for different applications. N_f is the number of frequency components in the PSD estimate.

Approximate entropy is able to distinguish low-dimensional deterministic system, chaotic system, stochastic, and mixed systems [75]. Approximate entropy was proposed by Pincus in 1991 [138], based on the work published in [139, 140]. It is a statistical parameter quantifying the regularity and complexity of a time series data of physiological signals [74, 75], and can be applied to both short-term and long-term data recordings. ApEn was initially developed to analyze medical data, but it also found application in various fields, such as finance or psychology.

The calculation of approximate entropy can be briefly described as follows, as indicated in [138, 75, 141]. Two input parameters, m and r , must be fixed to compute ApEn: m is the “length” of compared runs, and r is effectively a filter. Fix m , a positive integer, and r , a positive real number. Given a time series of data $u(1), u(2), \dots, u(N)$, i.e. N data points, from measurements equally spaced in time, form a sequence of vectors $x(1), x(2), \dots, x(N-m+1)$, such that $x(i)=[u(i), u(i+1), \dots, u(i+m-1)]$. These vectors represent m consecutive u values, commencing with the i th point. The distance $d(x(i), x(j))$ between vectors $x(i)$ and $x(j)$ is defined as the maximum difference in their respective scalar components

$$d(x(i), x(j)) = \max_{k=1,2,\dots,m} (|u(i+k-1) - u(j+k-1)|) .$$

For each i , $1 \leq i \leq N-m+1$, a measure of the regularity of patterns similar to a given pattern i of length m within a tolerance r can be defined as

$$C_i^m(r) = \sum_j s(r - d(x(i), x(j))) / (N - m + 1) ,$$

where $s(t)$ is the step function given by

$$s(t) = \begin{cases} 1, & t \geq 0 \\ 0, & t < 0. \end{cases}$$

Approximate entropy, ApEn(m, r), is defined as

$$ApEn(m, r) = \lim_{n \rightarrow \infty} [\Phi^m(r) - \Phi^{m+1}(r)],$$

where

$$\Phi^m(r) = (N - m + 1)^{-1} \sum_{i=1}^{N-m+1} \ln C_i^m(r).$$

For N data points, approximate entropy $ApEn(m, r, N)$ is estimated as

$$ApEn(m, r, N) = \Phi^m(r) - \Phi^{m+1}(r).$$

ApEn measures the likelihood that runs of patterns that are close for m observations remain close on next incremental comparisons. Greater likelihood of remaining close, regularity, produces smaller ApEn values, and conversely.

A slightly modified estimation of approximate entropy, sample entropy, was proposed by [142]. Sample entropy can be calculated as follows:

$$SampEn(m, r) = \lim_{n \rightarrow \infty} -\ln \frac{C^{m+1}(r)}{C^m(r)}.$$

7.2. Implemented system description

System for the approximate entropy based distinction of quiet and active sleep stages in full-term newborns encompasses several methods of the generalized EEG/PSG processing process, presented in more details in Chapter 4. Attention was focused on the data representation stage namely representation of signal by extracted features. Block diagram illustrating implemented system is given in Figure 7.1.

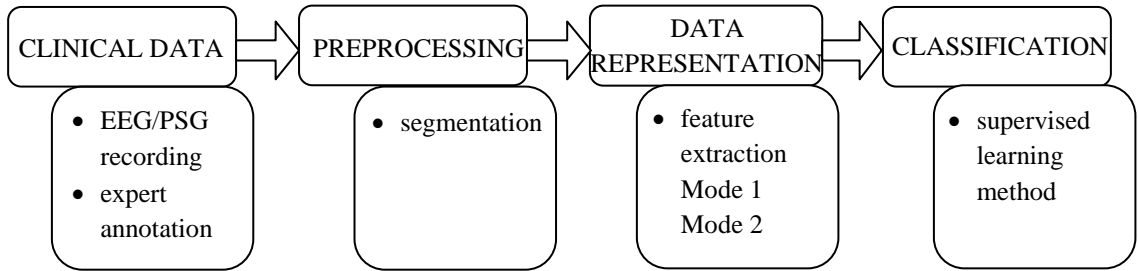

Figure 7.1: Scheme of the implemented system

Used dataset was introduced in Chapter 6. Within the preprocessing stage, each of eight EEG channels from available recordings were segmented to segments of constant, 15s long segments. Requirements for other steps in the computer assisted preprocessing were minimal due to the preselection of artifact-free segments by a medical expert for input.

Two modes were used within the data representation stage in order to form feature vectors:

- Mode 1: Within this mode, approximate entropy is calculated for raw EEG signals. Thus each segment is represented by a feature vector with 8 approximate entropy values, each individual value corresponding to EEG channel.
- Mode 2: This mode encompasses calculation of approximate entropy after the application of wavelet transform. In this mode, a set of features obtained in Mode 1 is enlarged by approximate entropy values of the wavelet coefficients. Wavelet decomposition is made to four levels in order to obtain, as explained in Chapter 4, approximations and details correspond to basic EEG frequency bands. Thus approximate entropy was calculated for delta, theta, alpha and beta frequency band. The structure of the used wavelet decomposition tree is presented in Figure 7.2. Daubechies 4 mother wavelet was used. Upon the completion of the computation of approximate entropy, mean value was computed for ApEn values computed for all EEG electrodes and this mean value was used as a feature. Thus within Mode 2, each feature vector consisted of 12 features – 8 approximate entropy values and 4 mean approximate entropy values computed for all electrodes and for basic EEG frequency bands.

Within the both modes, information was extracted from all EEG electrodes and used simultaneously in order to provide appropriate representation of behavioral states.

Approximate entropy was computed for the following values of m , N , and r (defined in the previous subsection): $m=2$, $N=15*128$, $r=q*STD$, where q varies from 0.1 to 0.9 in increments of 0.05 or 0.1, STD represents standard deviation of a signal segment, and sampling frequency is 128Hz. Approximate entropy values were computed for both quiet and active sleep segments.

For classification, Weka software was used, introducing supervised learning method. To be able to assess the performance of the proposed method, as well to compare the performance of different approaches to data representation based on approximate entropy, the same classifier, Naive Bayes was used in the final stage of signal processing process. The classification accuracy was evaluated through ten-fold cross-validation [143].

System for the approximate entropy based distinction sleep stages in full-term newborns was implemented in Matlab, with PSGlab toolbox, in connection with Weka software. PSGlab toolbox was introduced in Chapter 5. Due to its modular structure, this toolbox is suitable for implementation and verification of different approaches and methodologies. As already stated, PSGlab provides the interconnection with Weka software, thus export of the final representation of recordings from PSGlab to predefined file format for Weka is enabled.

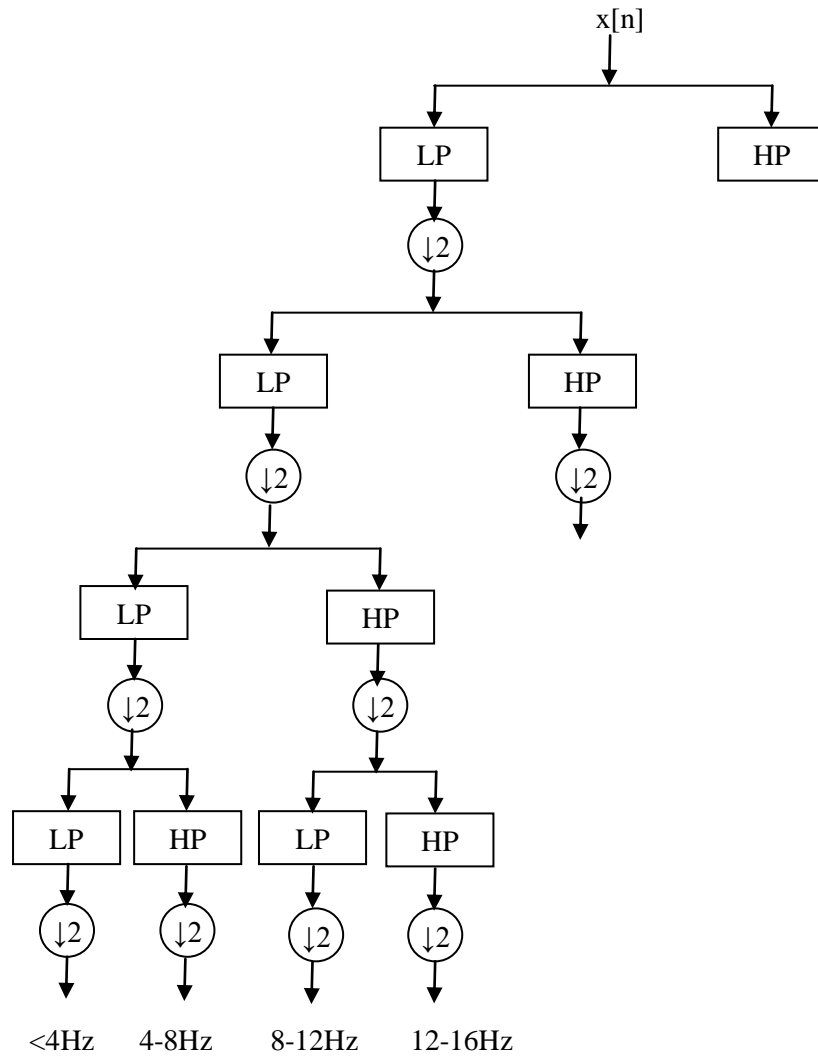

Figure 7.2: Wavelet decomposition to four levels, based on wavelet packet decomposition. Decomposition to basic EEG frequency bands is obtained.

Regarding performance evaluation, standard measures were used, namely sensitivity, specificity and overall classification accuracy, already introduced in Chapter 4. As two sleep stages were considered, quiet sleep (QS) and active sleep (AS), the performance was evaluated on the following measures:

- TP – classifier correctly identifies QS segment,
- TN – classifier correctly identifies AS segment,
- FP – segment labeled by the expert as QS was classified as AS,
- FN – segment labeled by the expert as AS was classified as QS.

Consequently, sensitivity, specificity and overall classification accuracy were computed.

7.3. Results

Used dataset was introduced in Chapter 6. EEG signals from PSG recordings of 22 subjects were analyzed.

Each of eight EEG channels was segmented to segments of constant length. Further on, features were extracted for each obtained 15s long segment. As data representation was based on the computation of the single feature, approximate entropy, Figures 7.3 – 7.6 illustrate box plots for obtained values of ApEn per electrode for individual behavioral state, for four different values of parameter r . Figures are plotted for a randomly chosen subject (subject 3).

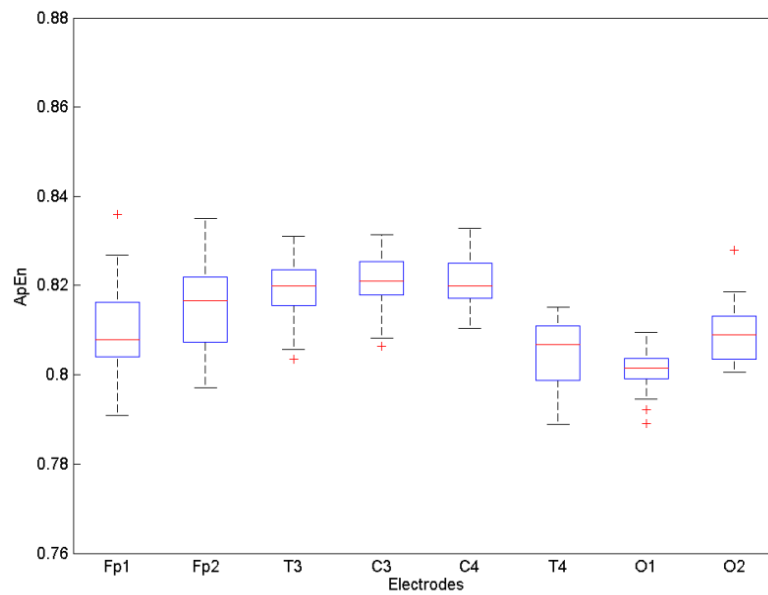

(a)

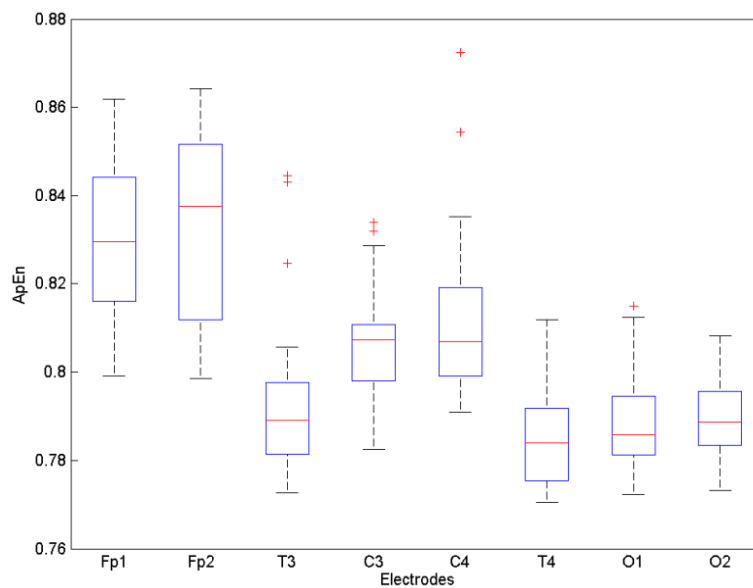

(b)

Figure 7.3: Approximate entropy values computed for EEG channels, with $r=0.1*STD$, for (a) quiet and (b) active sleep stages. 22 segments of QS and AS stages were used.

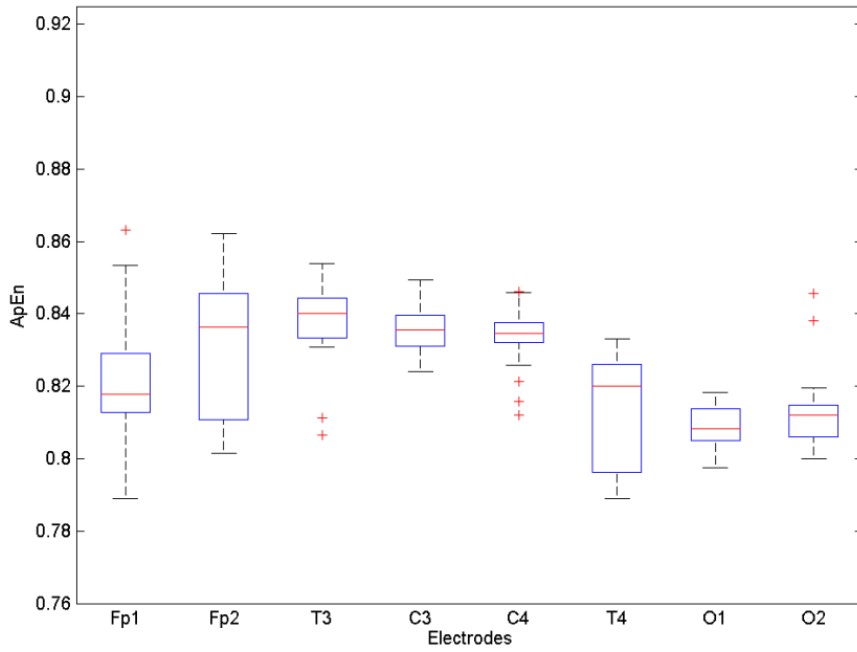

(a)

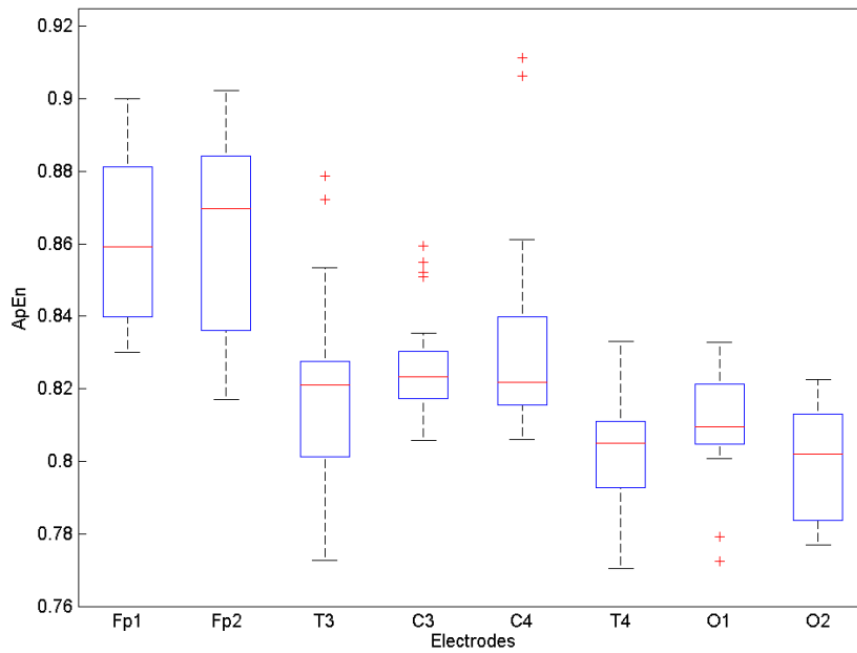

(b)

Figure 7.4: Approximate entropy values computed for EEG channels, with $r=0.2*STD$, for (a) quiet and (b) active sleep stages. 22 segments of QS and AS stages were used.

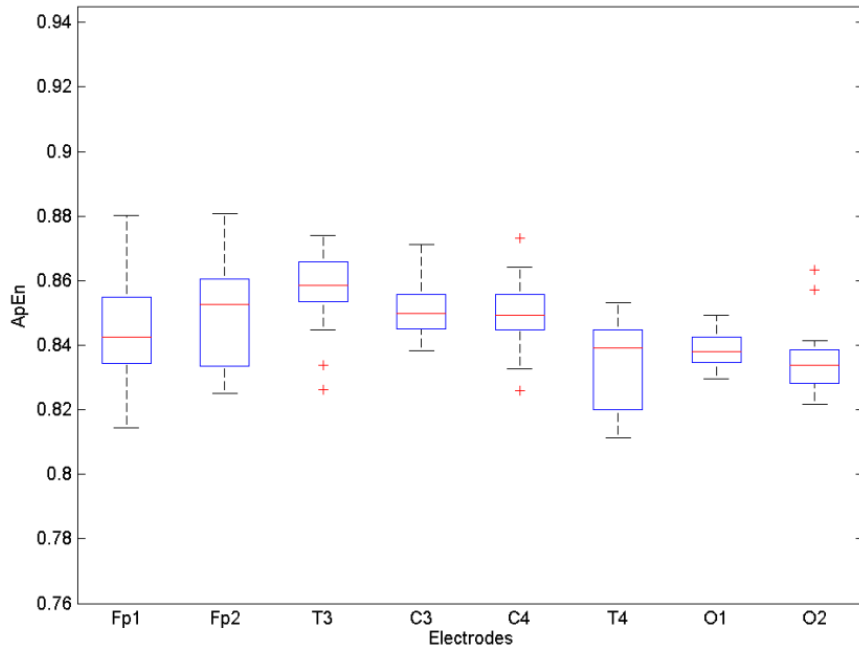

(a)

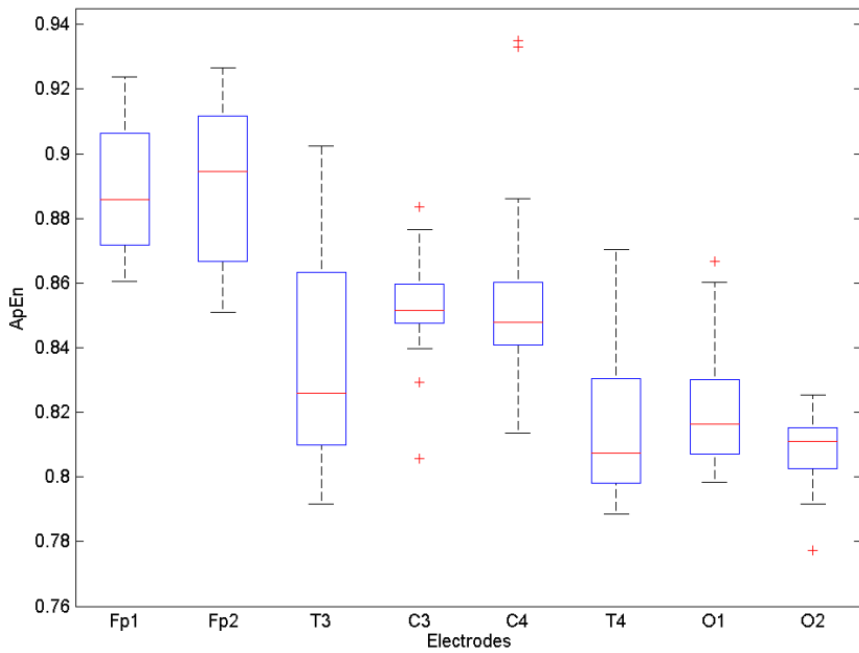

(b)

Figure 7.5: Approximate entropy values computed for EEG channels, with $r=0.3*STD$, for (a) quiet and (b) active sleep stages. 22 segments of QS and AS stages were used.

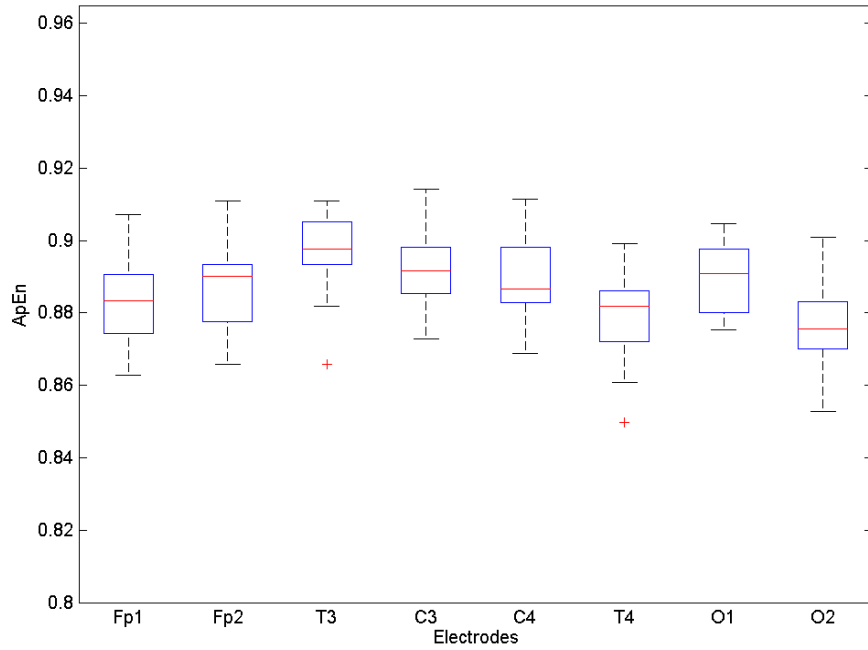

(a)

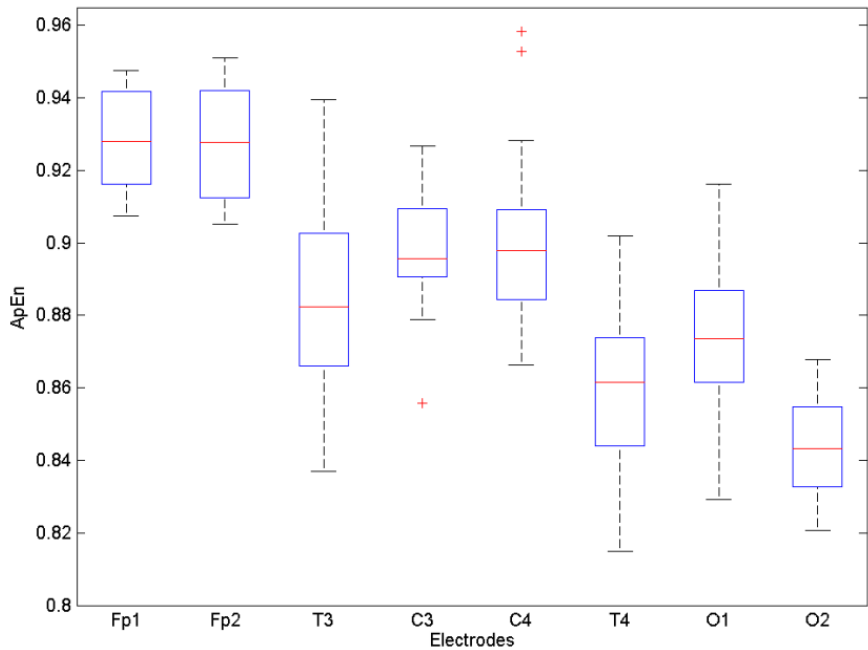

(b)

Figure 7.6: Approximate entropy values computed for EEG channels, with $r=0.6*STD$, for (a) quiet and (b) active sleep stages. 22 segments of QS and AS stages were used.

According to Mode 1 and Mode 2 explained in the previous subsection, appropriate feature vectors were created. Feature vectors obtained for quiet and active sleep formed training and testing datasets, and classification was performed. Table 7.1 presents values of obtained sensitivity and specificity, for Mode 1, depending on the parameter r used for the calculation of approximate entropy.

Table 7.1: Sensitivity (SEN) and specificity (SPE), obtained based on the feature vectors from Mode 1.

	q											
	0.1	0.15	0.2	0.25	0.3	0.4	0.5	0.6	0.7	0.8	0.9	
SEN (%)	85.5	80.2	82.2	81.9	82.7	80.6	80.6	81.1	80	80.4	79.8	
SPE (%)	80.3	76.2	79.1	81.2	83.3	83.9	83.9	84.4	85.4	85.1	85.5	

Table 7.2 presents values of obtained sensitivity and specificity, for Mode 2. Depending on the parameter r used for the calculation of approximate entropy.

Table 7.2: Sensitivity (SEN) and specificity (SPE), obtained based on the feature vectors from Mode 2.

	q											
	0.1	0.15	0.2	0.25	0.3	0.4	0.5	0.6	0.7	0.8	0.9	
SEN (%)	88.7	87.4	91.4	90.1	85.6	84.1	86.1	86.4	88.2	89	90.2	
SPE (%)	82.4	80.9	83.8	87.6	85.1	85.7	85.9	87.2	88.8	89.8	89.6	

Finally, Table 7.3 presents overall classification accuracy obtained for both Mode 1 and Mode 2.

Table 7.3: Overall classification accuracy (Acc), obtained based on the feature vectors both from Mode 1 and Mode 2.

Acc (%)	q											
	0.1	0.15	0.2	0.25	0.3	0.4	0.5	0.6	0.7	0.8	0.9	
Mode 1	82.8	78.17	80.64	81.56	83.01	82.08	82.08	82.59	82.39	82.49	82.29	
Mode 2	85.38	83.93	87.33	88.88	85.38	84.86	85.99	86.82	88.46	89.39	89.91	

7.4. Discussion

The presented system uses a single feature, approximate entropy, of recorded EEG signal, or of the same signal after the application of wavelet transform, for the distinguishing between neonate sleep states – quiet and active sleep.

In Chapter 5, a Matlab toolbox for processing of polysomnographic recordings was presented. Within the PSGlab it is enabled, among others, to compute various features, e.g. from time, frequency and time-frequency domain. In the course of preparation of this thesis, wide range of features was assessed. Obtained results showed potential of entropy based features in the field of EEG signal processing, especially of the approximate entropy. Consequently, special attention was focused on developing approach which will take the advantage of approximate entropy.

Results presented in the subsection 7.3. were obtained for segments of constant length (15s), formed both for quiet active sleep stages. During the testing period, different segment lengths were used. It was noted that the use of 15s long segments yielded to the best results, in the sense of classification accuracy and computational complexity. Also, adaptive segmentation, briefly introduced in Chapter 4, was tested, with appropriate parameter values. Adaptive segmentation algorithm was based on the principle of two connected windows of the same length, sliding along a signal and calculation of the differences of the defined parameters (combined amplitude and frequency difference) of these two windows, as proposed in [71] and applied, for example, in [132, 133, 134]. The overall classification accuracy did not exceed values obtained for 15s constant segmentation.

After inspection of results on Figures 7.3 to 7.6, as well as based on the results presented in Tables 7.1 to 7.3, it can be concluded that approximate entropy can be used for differentiation of quiet and active sleep stages in newborns. Although high classification accuracy (around 83%) was obtained after the computation of approximate entropy of the raw EEG signals, it was possible further to increase it with the application of wavelet transform. The utilization of this transform increased the classification accuracy to around 89.9%, which makes an increase of over 8%, without significant increase of the computational complexity.

Daubechies 4 was used as it is the most reported mother wavelet in the field of EEG studies. As the goal was to test and point out the importance of the wavelet transform, other wavelet functions were not used. Based on the results reported in [72], it can be assumed that application of other parameters of the wavelet transform might lead to the further increase of the classification accuracy. Anyhow, the goal here was to test and point out the importance of the wavelet transform. Further on, it was stated that wavelet decomposition was made to four levels. Due to the importance of the low frequencies in newborns' EEG, the decomposition to five levels was also tested. Decomposition to five levels and subsequent calculation of approximate entropy of the newly obtained wavelet coefficients, corresponding to sub-bands of delta band, i.e. frequencies <2Hz and between 2Hz and 4Hz, did not lead to better classification results. In the previous subsection two phases were explained. Mode 1 was considered to be a referent one, only with approximate entropy features, and results obtained with Mode 2 were presented due to the highest overall classification accuracy. Besides these two modes other possibilities were also considered: in connection with Mode 2, two more ways to form a feature vector were tested. It was concluded that feature vector of 40 values – 8 approximate entropy values, 8 approximate entropy values computed for delta band, 8

approximate entropy values computed for theta band, 8 approximate entropy values computed for alpha band and 8 approximate entropy values computed for beta band – does not provide additional, non-redundant information. Thus this did not lead to the improvement of the classification accuracy. It was concluded also that feature vector of 5 values – a single mean approximate entropy value for all electrodes and 4 mean approximate entropy values computed for all electrodes and for typical EEG frequency bands – decreases the overall classification accuracy.

In different publications, for the computation of approximate entropy common values of the parameter r range from 0.1 to $0.25 * \text{STD}$ (standard deviation of a signal segment). Maximum approximate entropy values does not always occur within the prescribed range of r values. According to [144], the maximum approximate entropy leads to the correct interpretation of a signal's complexity. Here, values of the parameter r were taken from a wider range, namely from 0.1 to $0.9 * \text{STD}$. This way, it was found that values of the parameter r above $0.25 * \text{STD}$ are also relevant: for Mode 1 and Mode 2 maximal overall classification accuracy was achieved for $0.3 * \text{STD}$ and $0.9 * \text{STD}$, respectively.

Only EEG channels from PSG recordings were analyzed. Although in the literature it was reported that the differentiation between classes is achieved also by including information from polygraphic channels other than EEG from PSG recordings, in this study it was shown that, by applying appropriate methodology in order to extract information about psychophysiological state of the brain and their changes, EEG based information is sufficient for the differentiation of the neonatal behavioral states. Based on the results, it can be concluded that approximate entropy, together with wavelet transform, can differentiate well between quiet and active sleep stages, providing high classification accuracy, and thus can be used in the field of neonatal sleep EEG analysis.

To the best of our knowledge, wavelet transform and approximate entropy are used for the first time in the proposed system for the classification of sleep stages in newborns. Based on obtained and presented results, it can be concluded that this approach can be used in the field of neonatal sleep EEG analysis, as it provides high classification accuracy.

Obtained results can be used as reference for developing or enhancing neonatal sleep EEG/PSG classification algorithms. The disadvantage of the work with sleep neonatal recordings is that experiments are conducted on relatively small datasets, and that these kind of clinical recordings are not widely available. Thus one of the main obstacles for the improvement in the field of preterm or full-term neonatal EEG/PSG analysis and classification is the lack of publicly accessible database.

7.4.1. Novelty and significance

Approximate entropy and wavelet transform are used for the first time in the proposed system for the classification of sleep stages in full-term newborns. It was also shown that features extracted only from EEG signals can be used for the separation of sleep stages and that high classification accuracy can be achieved. Presented approach may

provide a reference for the development and enhancement of neonatal EEG/PSG stage recognition algorithms, improving their accuracy, or complementing present diagnostic methods.

Chapter 8

Analysis based on Hurst exponent

The Hurst exponent is used as a measure of long-term memory of time series. It characterizes self-similarity in the signal. Also, Hurst exponent is used to characterize the fractional or scaling property of the EEG signals. In this Chapter, brief overview of the theoretical background for Hurst exponent will be given, results of the analysis based on this exponent will be presented and discussed.

8.1. Theoretical background

The Hurst exponent is used in several areas of applied mathematics, including fractals and chaos theory and long-term memory processes. Hurst exponent has been applied in many different areas, ranging from biophysics to computer networking, finances to ecology. The Hurst exponent is used as a measure of long-term memory of time series. It is also directly related to the fractal dimension - a small value of Hurst exponent indicates a higher fractal dimension and vice versa.

Estimation of the Hurst exponent was originally developed in hydrology, for the practical matter of determining optimum dam sizing for the river Nile, having in mind its changes that had been observed over a long time period. The name Hurst exponent or coefficient derives from Harold Edwin Hurst, who was the lead researcher in these studies. The use of the standard notation H for the coefficient relates to his name also.

The method which was introduced by Hurst, for the problem stated in the previous paragraph, is known as rescaled range analysis or the R/S statistics or analysis. A brief description of R/S analysis was given, for example, in [92, 145]. Hurst observed the maximum difference from the mean value, in the series of j time samples, $X = x_1, x_2, \dots, x_j$:

$$W_j = \sum_1^j (x_i - E[X]).$$

The widest range of values, observed till the moment k , $R(k)$, corresponds to

$$R(k) = \max(0, W_1, W_2, \dots, W_n) - \min(0, W_1, W_2, \dots, W_n).$$

This obtained value of $R(k)$ is normalized with the standard deviation value $S(k)$, which represents the calculation of the mean value rescaled range $R(k)/S(k)$:

$$E\left[\frac{R(k)}{S(k)}\right] = C n^H .$$

The Hurst exponent is estimated by fitting the power law to the data – as a function of $\log n$, and fitting the straight line – the slope of the line will give the value of the Hurst exponent.

Today, besides R/S analysis for the estimation of the Hurst exponent, several different methods have been proposed. The most used are periodogram method (Fourier spectral technique) and detrended fluctuation analysis. The main particularity of these methods is that they generally analyze the time series as a whole, providing a single value of Hurst Exponent that characterizes times series globally.

The Hurst exponent can take values between 0 and 1 ($0 \leq H \leq 1$):

- A value H in the range 0.5–1 indicates a time series with long-term positive autocorrelation, meaning both that a high value in the series will probably be followed by another high value and that the values a long time into the future will also tend to be high.
- A value in the range 0 – 0.5 indicates a time series with long-term switching between high and low values in adjacent pairs, meaning that a single high value will probably be followed by a low value and that the value after that will tend to be high, with this tendency to switch between high and low values lasting a long time into the future.
- A value of $H=0.5$ can indicate a completely uncorrelated series, but in fact it is the value applicable to series for which the autocorrelations at small time lags can be positive or negative but where the absolute values of the autocorrelations decay exponentially quickly to zero.

8.2. Implemented system and results

EEG signals from PSG recordings of 22 subjects were analyzed. This dataset, consisting of quiet and active stage artifact-free segments annotated by experienced neurologist, was dataset introduced in Chapter 6. Each of 8 EEG channels was processed. For each subject, data were preprocessed in a way that all the segments corresponding to quiet or active sleep stage were grouped together, forming a single segment for each stage. Further on, Hurst exponent of a given sequence was estimated with R/S method.

Figures 8.1 to 8.8 illustrate results obtained by this method for subject 3, as this subject was randomly chosen and represented also in Chapter 7, presented on a log-log scale, for each EEG electrode and each behavioral state. Hurst exponent was estimated based on 50 different values of m , as shown on these figures, which is a parameter proportional to the segment length. Value of the Hurst exponent is visualized as the

slope of the straight non-dashed (red) line in the figures. As it can be clearly identified from Figures 8.1 to 8.8, that values of Hurst exponent differ for sleep stages.

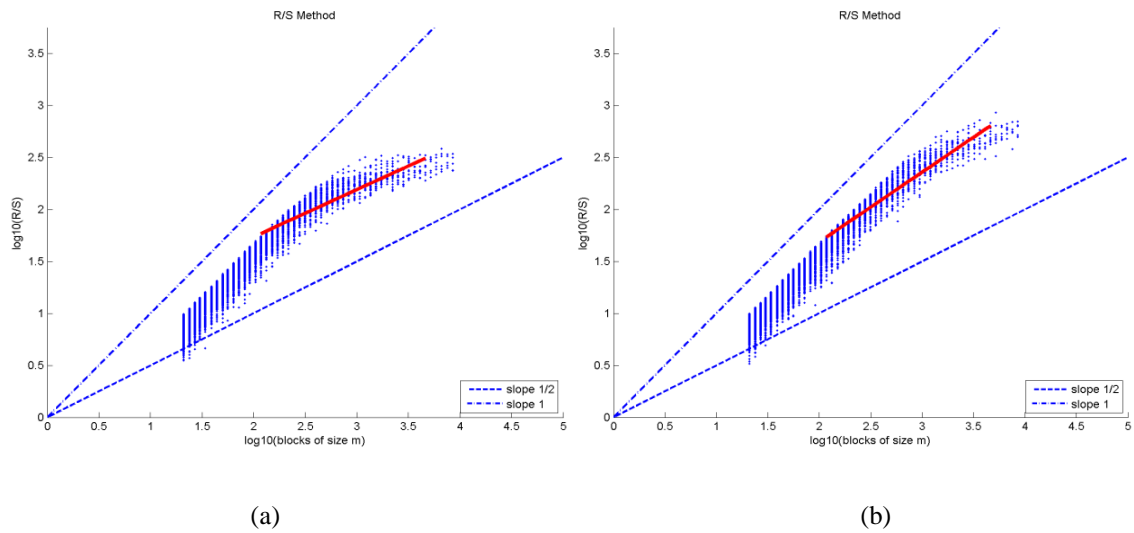

Figure 8.1: R/S estimation of the Hurst exponent, channel Fp1, for (a) quiet and (b) active sleep stage.

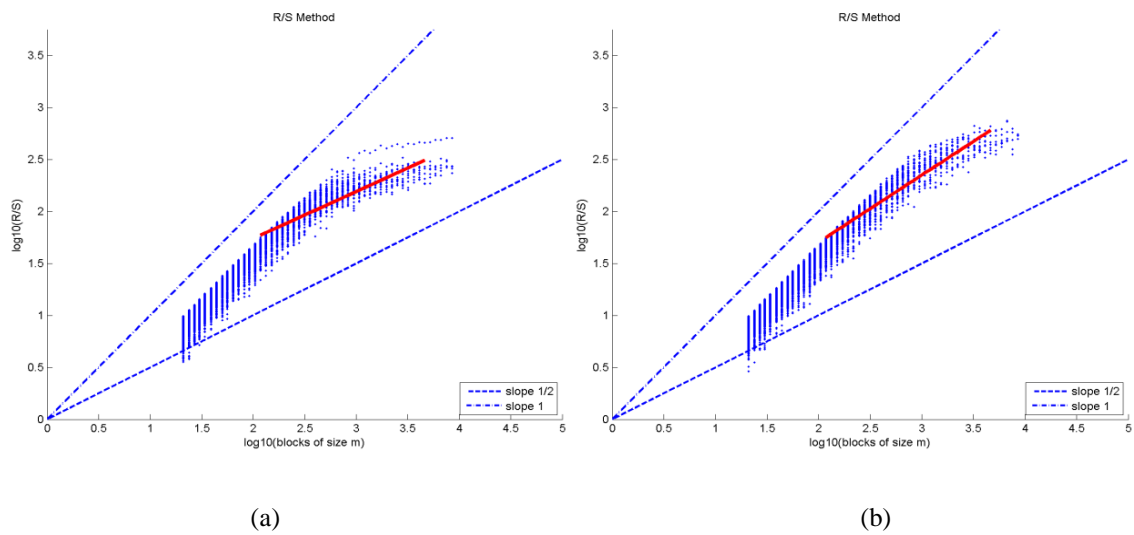

Figure 8.2: R/S estimation of the Hurst exponent, channel Fp2, for (a) quiet and (b) active sleep stage.

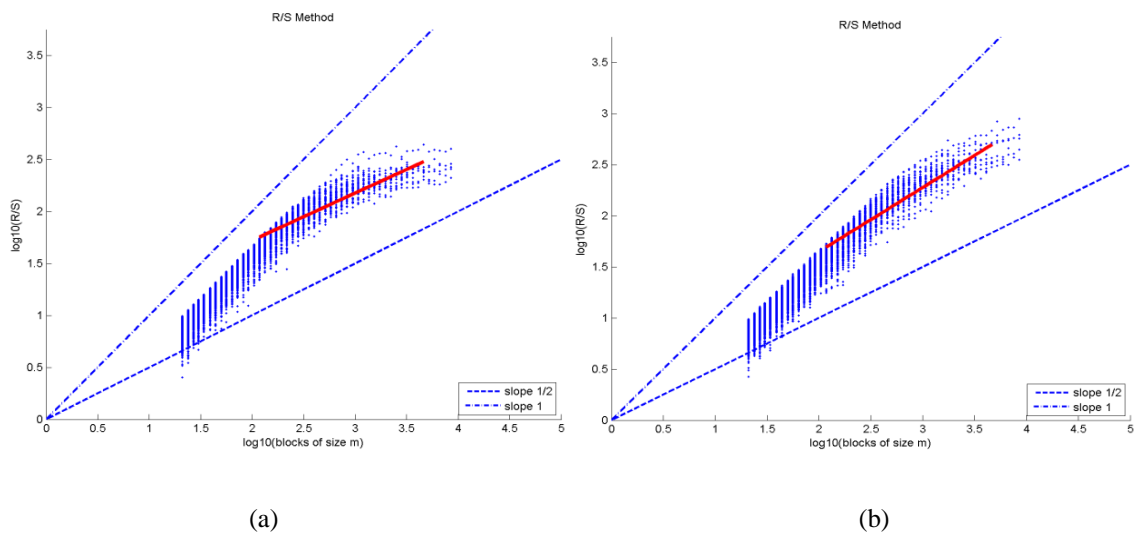

Figure 8.3: R/S estimation of the Hurst exponent, channel T3, for (a) quiet and (b) active sleep stage.

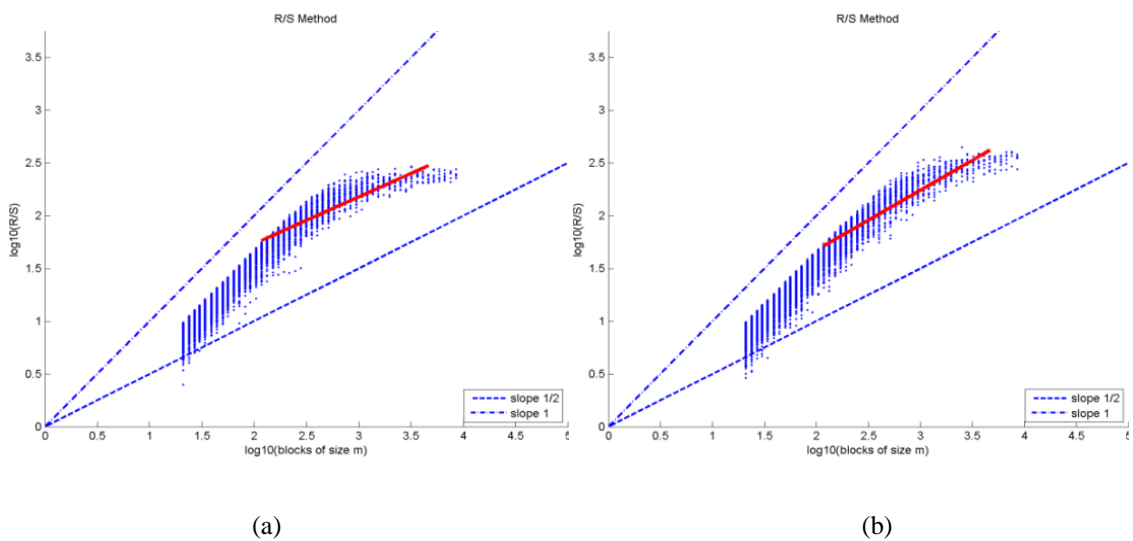

Figure 8.4: R/S estimation of the Hurst exponent, channel C3, for (a) quiet and (b) active sleep stage.

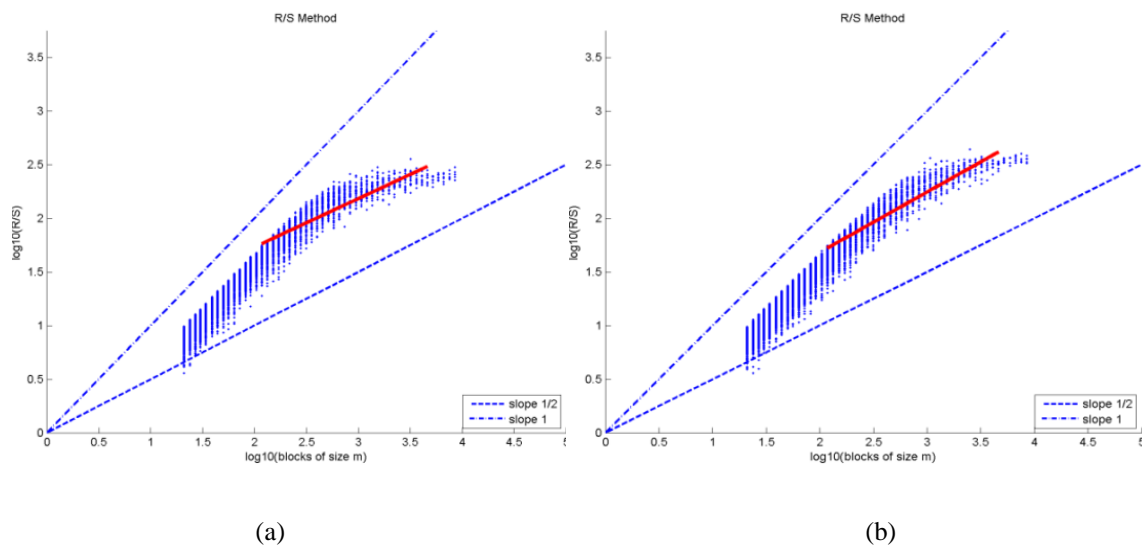

Figure 8.5: R/S estimation of the Hurst exponent, channel C4, for (a) quiet and (b) active sleep stage.

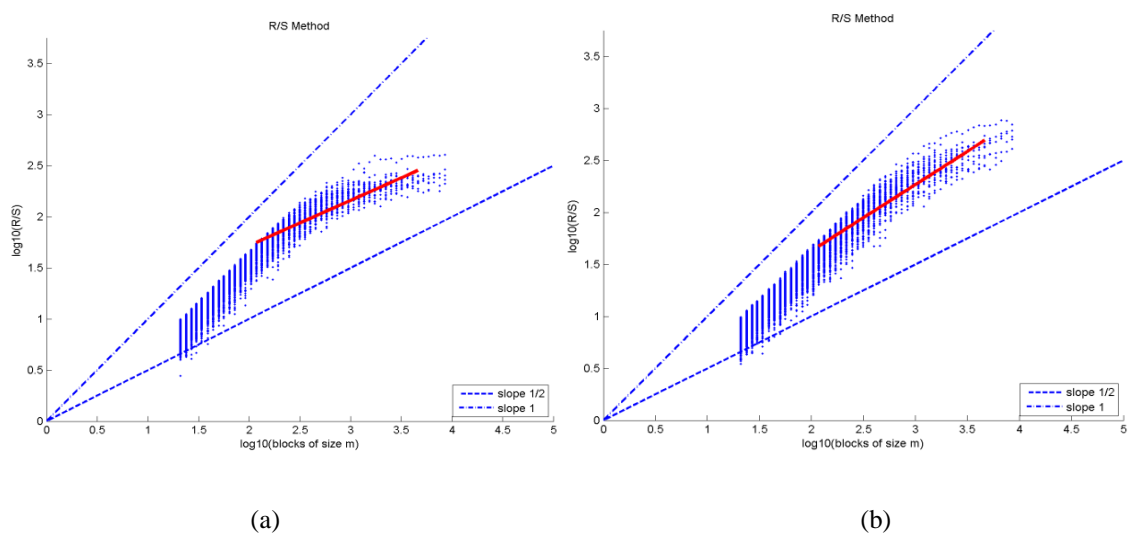

Figure 8.6: R/S estimation of the Hurst exponent, channel T4, for (a) quiet and (b) active sleep stage.

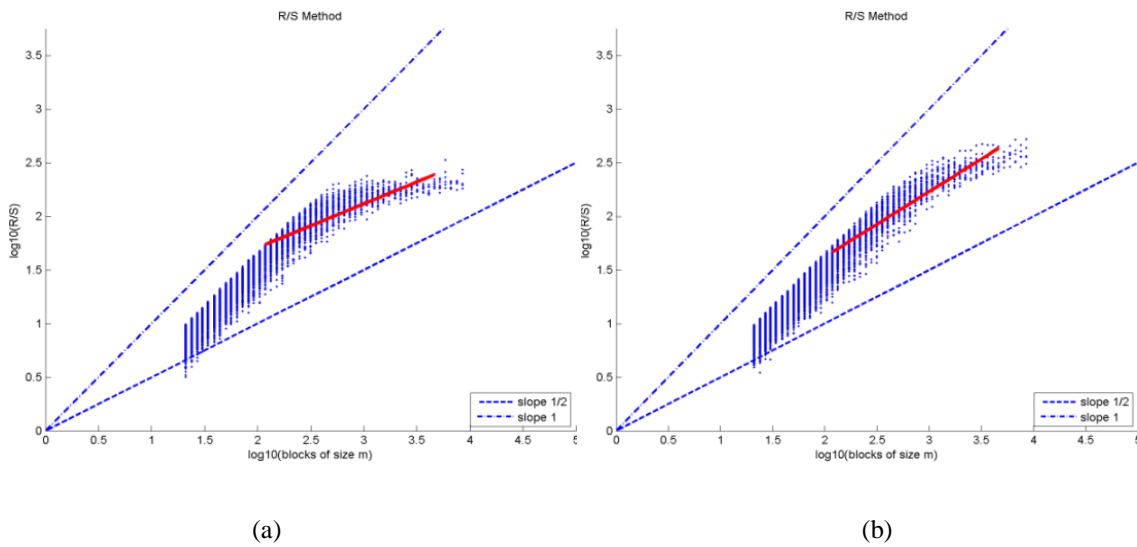

Figure 8.7: R/S estimation of the Hurst exponent, channel O1, for (a) quiet and (b) active sleep stage.

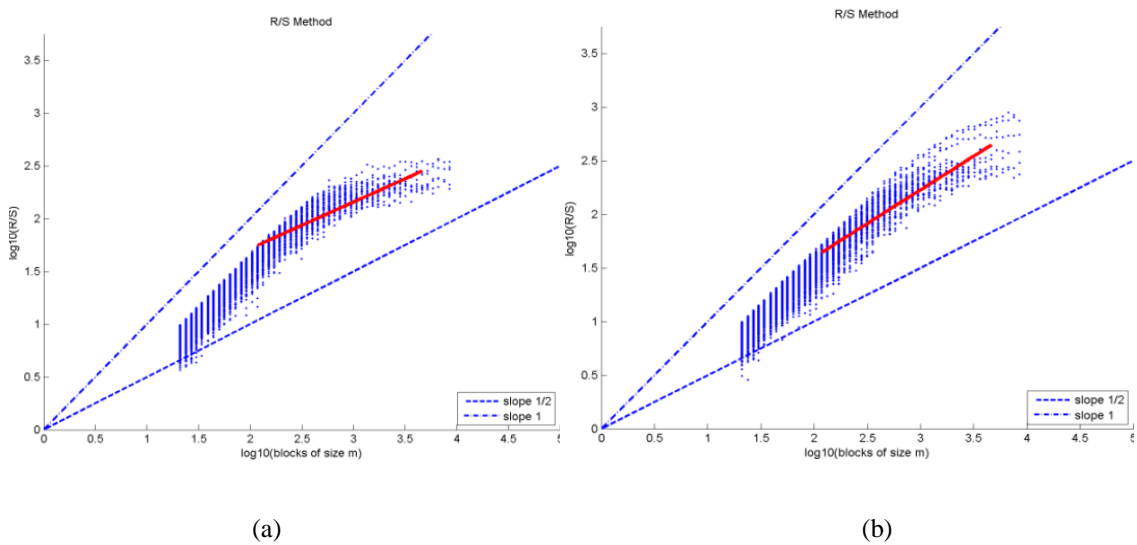

Figure 8.8: R/S estimation of the Hurst exponent, channel O2, for (a) quiet and (b) active sleep stage.

For each subject, obtained values of Hurst exponent for each EEG channel were used to create box plots. These plots are presented in Figures 8.9 to 8.12. Every figure illustrates values of Hurst exponent for quiet and active sleep stage separately, for two subjects from the dataset. Again, it can be identified how values of Hurst exponent differ for sleep stages.

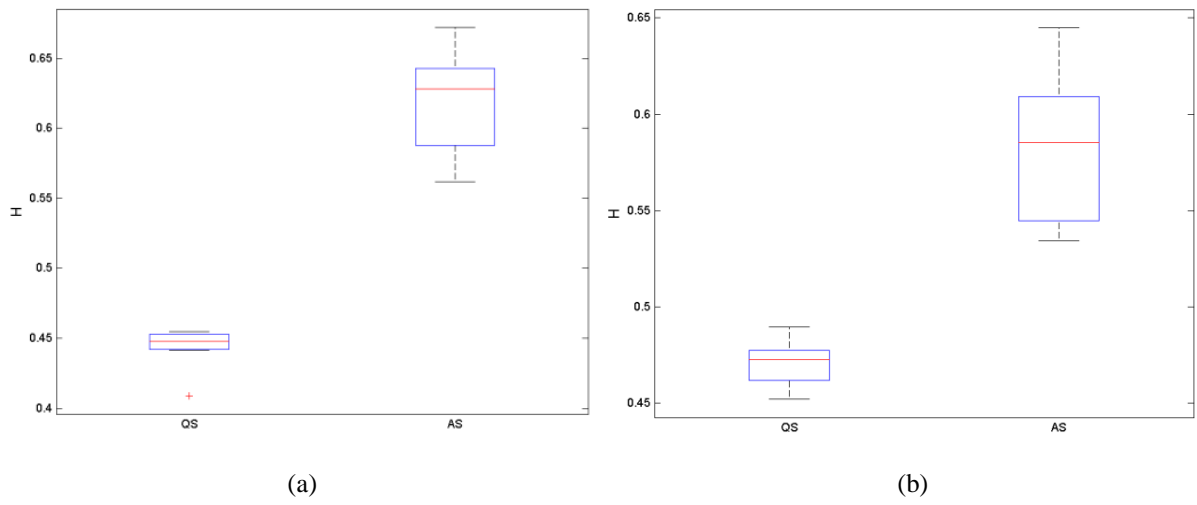

Figure 8.9: Values of the Hurst exponent, estimated for each EEG channel, for quiet and active sleep stages, for (a) subject 3 and (b) subject 4.

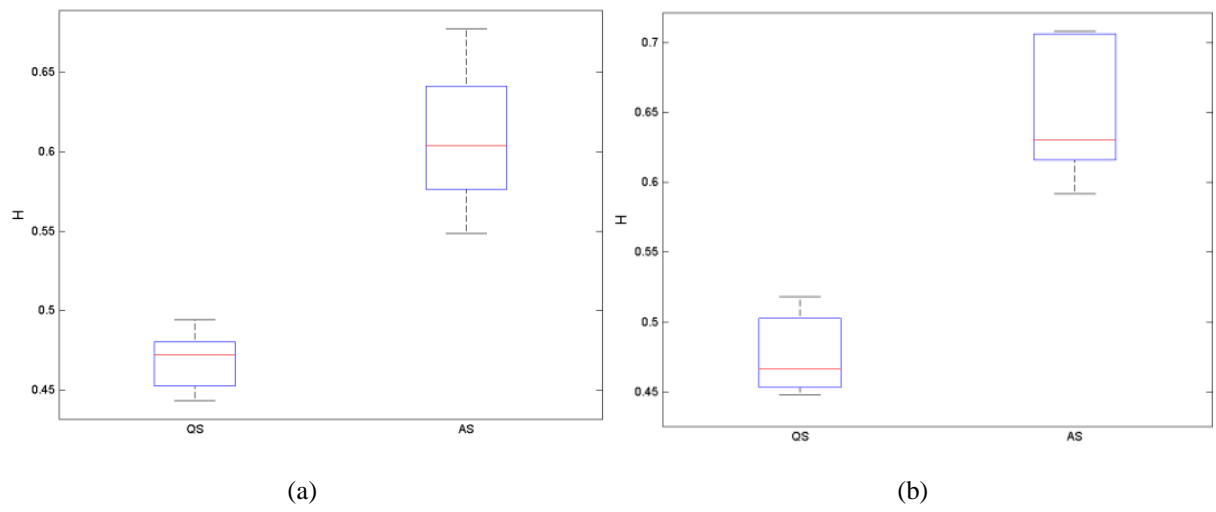

Figure 8.10: Values of the Hurst exponent, estimated for each EEG channel, for quiet and active sleep stages, for (a) subject 5 and (b) subject 8.

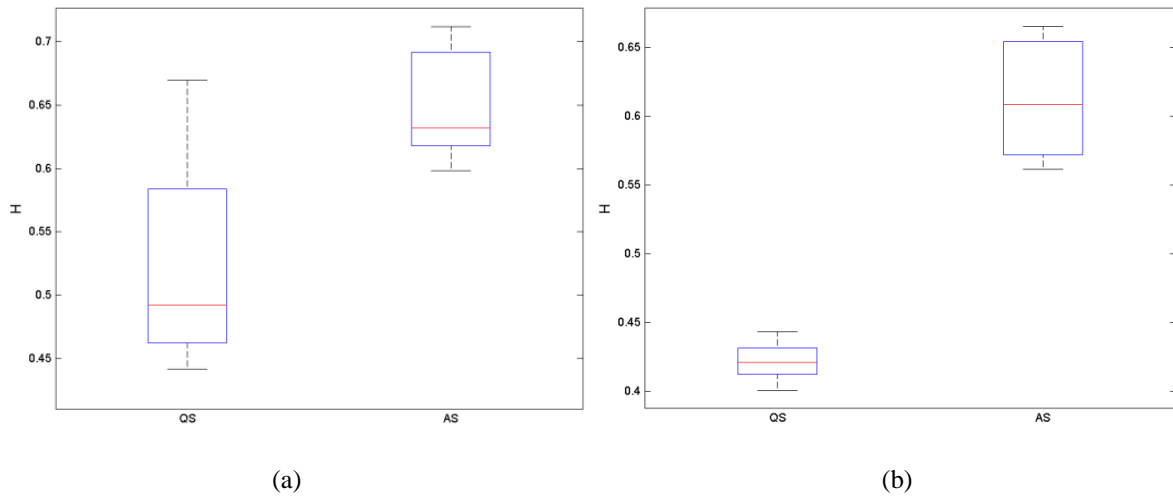

Figure 8.11: Values of the Hurst exponent, estimated for each EEG channel, for quiet and active sleep stages, for (a) subject 9 and (b) subject 15.

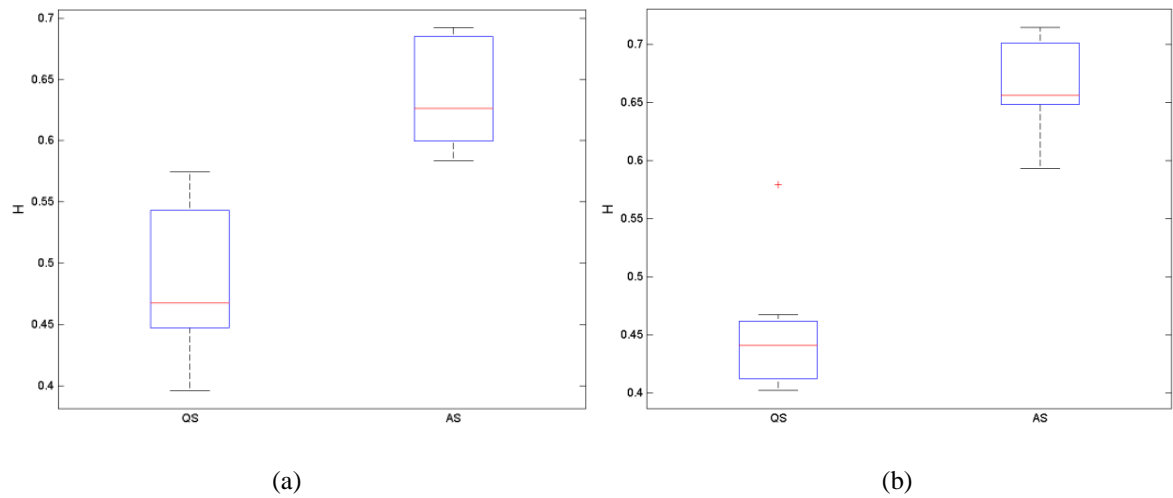

Figure 8.12: Values of the Hurst exponent, estimated for each EEG channel, for quiet and active sleep stages, for (a) subject 17 and (b) subject 20.

Tables 8.1 to 8.4 present values of the Hurst exponent for 8 EEG channels, together with their mean values, for 8 subjects from the dataset (other than subjects whose results were presented in Figures 8.9 to 8.12), both for quiet and active sleep stage. It can be noticed that the mean value of the Hurst exponent is lower for quiet than for active sleep stage for all subjects, as well as that values of this exponent for the same electrode is always lower for quiet than for active sleep stage.

Table 8.1: Values of the Hurst exponent for EEG channels, for subjects 6 and 7.

	Subject 6		Subject 7	
	QS	AS	QS	AS
Fp1	0,4466	0,5689	0,4293	0,5324
Fp2	0,4419	0,5509	0,4492	0,5736
T3	0,4706	0,5701	0,4197	0,5408
C3	0,4385	0,5495	0,4262	0,5258
C4	0,4427	0,5422	0,4537	0,5837
T4	0,5257	0,638	0,3862	0,5685
O1	0,4211	0,4714	0,4404	0,6863
O2	0,4445	0,4834	0,4451	0,6336
Mean value	0,4539	0,5468	0,4312	0,5805

Table 8.2: Values of the Hurst exponent for EEG channels, for subjects 11 and 13.

	Subject 11		Subject 13	
	QS	AS	QS	AS
Fp1	0,4915	0,6511	0,4716	0,5885
Fp2	0,6244	0,6793	0,4406	0,5663
T3	0,4114	0,5795	0,4676	0,5148
C3	0,484	0,6153	0,4786	0,5432
C4	0,4397	0,5503	0,4709	0,5421
T4	0,4309	0,5936	0,468	0,5563
O1	0,4728	0,635	0,5087	0,6542
O2	0,4815	0,6292	0,4816	0,5772
Mean value	0,4795	0,6167	0,4734	0,5678

Table 8.3: Values of the Hurst exponent for EEG channels, for subjects 14 and 16.

	Subject 14		Subject 16	
	QS	AS	QS	AS
Fp1	0,4753	0,6683	0,4352	0,6128
Fp2	0,4983	0,7187	0,425	0,625
T3	0,5489	0,7591	0,4261	0,5967
C3	0,5686	0,767	0,453	0,5734
C4	0,4932	0,7356	0,4259	0,5622
T4	0,4978	0,7413	0,4248	0,5768
O1	0,4547	0,6507	0,4536	0,607
O2	0,4975	0,7054	0,4534	0,5964
Mean value	0,5043	0,7183	0,4371	0,5938

Table 8.4: Values of the Hurst exponent for EEG channels, for subjects 18 and 19.

	Subject 18		Subject 19	
	QS	AS	QS	AS
Fp1	0,4475	0,6685	0,4319	0,6806
Fp2	0,4536	0,6714	0,4568	0,6705
T3	0,4357	0,5841	0,4357	0,6425
C3	0,4252	0,5948	0,4328	0,5885
C4	0,4391	0,6346	0,436	0,6093
T4	0,4267	0,665	0,4504	0,642
O1	0,4272	0,6393	0,4494	0,5841
O2	0,4334	0,6135	0,4426	0,5918
Mean value	0,436	0,6339	0,4419	0,6262

8.3. Discussion

The presented analysis of EEG sleep stages was based on the computation of a single feature – Hurst exponent.

PSGlab toolbox, introduced in Chapter 5, provides the possibility of computation of Hurst exponent, among other various features, mentioned also in subsection 7.4. Due to the complex nature of EEG signals, the assumption was made that Hurst exponent could be a valuable tool in the field EEG signal processing. During the development and testing of algorithms for sleep staging, where various features were designed and their combinations tested, the potential of Hurst exponent was also confirmed. That is why special attention was dedicated to the analysis based on this particular exponent.

Results of the analysis were presented in the subsection 8.2. During the testing period, different segment lengths were used, and it was noted that the increase of the segment length yields to better differentiation between two stages of interest. Adaptive segmentation, introduced in Chapter 4 and subsection 7.4, was also tested, but segmentation to segments of variable length did not lead to better staging.

The Hurst exponent was estimated with R/S method, although there are several methods for the estimation of this exponent. This is based on the finding that values of this exponent estimated by the R/S method gave better results than when the estimation performed with the periodogram method, meaning that stages can be clearly differentiated.

Figures 8.1 to 8.8 visualize estimation of Hurst exponent and its value. It should be noticed that different sleep stages form different shapes in figures. By fitting the computed values with a polynomial, the line whose slope defines the Hurst exponent value is obtained. Besides the significance of the value of the Hurst exponent for the classification of sleep stages, this can be used as a basis for the visual representation of segments corresponding to quiet or active sleep stage.

The value of Hurst exponent is not only important for the classification, but also for the description and characterization of the signal. As already mentioned in this chapter, values of the Hurst exponent can be grouped into two intervals, $0 < H < 0.5$ and $0.5 < H < 1$, or the value of this exponent can be 0.5. For 19 out of 22 subjects in the dataset, mean value of the Hurst exponent computed for all 8 EEG channels was lower than 0.5 for quiet sleep, and higher than 0.5 for active sleep. Based on these results, quiet sleep in full-term newborns can be interpreted as a negatively correlated process, or anti-persistent process, while active sleep in full-term newborns can be interpreted as a positively correlated process. The rest of the subjects from the dataset, namely 3 subjects, had mean values of the Hurst exponent higher than 0.5 both for quiet and active sleep, but again with the lower value for quiet sleep stage. It should be tested if these values would change if the length of the segments corresponding to sleep stages increase, especially if the mean value of the Hurst exponent for quiet sleep would decrease below 0.5.

To the best of our knowledge, the analysis of the sleep EEG recordings in full-term newborns, based on signals from all 8 electrodes and estimation of the Hurst exponent, was not conducted. Based on obtained and presented results, it can be concluded that the Hurst exponent can be used in the field of neonatal sleep EEG analysis, as it can differentiate well between quiet and active sleep stages.

8.3.1. Novelty and significance

Analysis of sleep EEG in full-term newborns based on Hurst exponent was reported for the first time. It was shown that features extracted only from EEG channels can be used for the purpose of sleep stage differentiation. Hurst exponent is proven to be an effective analysis tool, which can also contribute to the better understanding of the nature of EEG sleep behavioral states. Representation of stages by Hurst exponent, both in numerical or visual form, makes a good basis for the development of stage recognition algorithms as well as for visualization that could ease the work of medical doctors.

Chapter 9

Conclusion and outlook to the future

The problem of automated classification of EEG/PSG signals is very complex, especially in the field of neonatal analysis. At the moment, there is no robust and reliable technique for fully automated computerized processing of this type of signal. In the clinical practice, neurologists use atlases and the experience that they have acquired for a purely visual evaluation. It is a very difficult task to convert this knowledge and experience of EEG signal evaluation into an automated computer approach. From the other side, computer-assisted analysis may provide additional information and show trends that cannot be revealed only by visual inspection, and represent it in a convenient form. This type of analysis may also contribute to the better understanding of signals nature and characteristics. Motivation for introducing computer-assisted processing of EEG is also the simplification of the work of medical doctors and making the evaluation more objective. It should be stressed out that automatic algorithms do not intend to be used instead of an expert, but as a decision support tool.

Due to the complexity of the EEG signal, processing of this kind of signal represents a complex multilevel procedure, consisting of several stages. Main steps in the processing process are preprocessing, data representation and classification. Each of these stages encompasses several mandatory or optional substeps. Special attention needs to be focused on the data representation stage, which includes feature extraction. It is important in order to reveal significant differences within different classes and describe subtle changes in the psychophysiological state of the brain. The representation of data in a convenient form is also important because it can directly influence classification accuracy.

This thesis provides a reference for enhancing the differentiation of individual neurological sleep states and for the improvement of existing computer-assisted approaches. The capability of approximate entropy and Hurst exponent to reveal hidden clinical information in the field of neonatal sleep EEG analysis was demonstrated.

The combination of approximate entropy and wavelet transform were used for the first time in the proposed system for the classification of sleep stages in full-term newborns. Extracted information from all EEG channels was used simultaneously in order to provide appropriate representation of behavioral states. It was shown that EEG based information was sufficient for the classification. Based on obtained results, it can be concluded that this approach can be used in the field of neonatal sleep EEG analysis, as it provides high classification accuracy.

Analysis of EEG signals based on the estimation of Hurst exponent was conducted. Hurst exponent is proven to be an effective analysis tool, which can also contribute to

the better understanding of the nature of EEG sleep behavioral states. Based on the obtained results, it can be concluded that the Hurst exponent can be used in the field of neonatal sleep EEG analysis, as it can differentiate well between quiet and active sleep stages.

The designed methods could also be applied to tasks in the similar problem domains.

9.1. Accomplishment of the objectives

As stated in Chapter 1, the main goal was to propose a methodology of EEG signal processing that could support the clinicians with assessment of EEG/PSG recordings in the field of sleep in full-term neonates. The attention was focused specially on data representation stage in the multistage processing system, namely representation of EEG signal by extracted nonlinear features. In this section, the achieved goals of the thesis are summarized by mapping achievements to predefined goals.

1. *Development of a novel methodology for neonatal sleep EEG analysis.* A comprehensive methodology for computer assisted processing and evaluation of sleep EEG recordings in neonates was proposed and tested. General methodology for PSG/EEG signal processing was introduced in Chapter 4. Further on, in Chapters 5, 7 and 8 the implementation of the proposed methodology, throughout the PSGlab toolbox for Matlab, was summarized. This existing toolbox was used as a basis, and it was extended with necessary files. This way, the toolbox can be used for unknown multichannel EEG signals, as well as for further experiments on newly obtained data. Testing was conducted on the dataset consisting of 22 subjects, recorded in a medical institution and annotated by experienced neurologist. This dataset of PSG recordings of newborns is larger than datasets that are freely accessible online, and it was used for validation of the proposed methodology.
2. *Extraction of clinically relevant information.* Nonlinear features that were extracted from EEG signals were approximate entropy and Hurst exponent. Wavelet transform was also applied to EEG signals, which was followed by the computation of the approximate entropy. It is important to stress out that information were extracted for all EEG channels, and that obtained information was further combined in order to use it in the most appropriate way. Results were in more details presented in Chapters 7 and 8. Obtained results show that in the presented way clinically relevant information were extracted.
3. *Verification of sufficiency of the EEG based information.* In the available literature it was reported that the differentiation between classes can be improved, among other ways, by including information from other polygraphic channels from PSG recordings. Although EEG signal contains information about psychophysiological state of the brain and their changes, it is necessary to apply appropriate methodology in order to extract this information. In this thesis only EEG channels from PSG recordings were analyzed. By extracted

specific features, and by their appropriate combination, it was proven that necessary information from EEG signal can be extracted, and it was confirmed that EEG based information is sufficient for the differentiation of the neonatal behavioral states.

4. *Verification of a classification potential of extracted features on real clinical recordings.* By the extraction of the nonlinear features, it was enabled for the proposed system to distinguish between sleep stages, which are important for the assessment of the maturation of the neonatal brain. Hurst exponent was estimated, and approximate entropy was calculated both for the raw EEG signals and for the same signals after the application of the wavelet transform. Extracted information was combined in the appropriate form. Obtained results for the real clinical recordings were presented and discussed in Chapters 7 and 8. Based on these results, it can be concluded that Hurst exponent and approximate entropy can differentiate well between quiet and active sleep stages in full-term newborns, providing high classification accuracy, and thus can be used in the field of neonatal sleep EEG analysis.

9.2. Future work

The field of EEG/PSG automated analysis is very wide. A lot of work has been done but much more has to be done in this developing field in order to introduce automated analysis in the everyday clinical practice. Thus future work should be oriented both to the introduction of improvement both from the technical and medical perspective.

Presented methodology and results provide a reference for enhancing the differentiation of individual neurological states in the neonatal sleep and for the improvement of existing approaches. In this thesis were presented obtained promising results, which should be confirmed on a larger database. The creation of a larger database in cooperation with relevant medical institutions will lead to the further improvements, both from the medical and technical point of view.

Introduction of new, additional extracted features may also lead to the further improvement. Improvement of the presented model might be gained by using multi-fractal analysis. This analysis should be used within the data representation stage in the EEG processing process. This way, multi-fractal features, which already implied good results in various fields of biological signal processing in the last years, may be used to describe important changes in the EEG signal for the differentiation of sleep states. Interpretation of obtained results may lead to better understanding of the EEG signal nature and complex processes of the neonatal brain.

Further on, the developed and tested methodology should be adjusted and modified to make it able to process EEG signal in the real time, which could be used, for example, for continuous non-invasive monitoring of neonatal brain activity in an intensive care unit. This support of online processing is improvement from the technical point of view, which implies medical improvement important for the everyday clinical practice. In

connection with this, the attention in the future should also be focused on the development of advanced visualization methods and graphical user interface.

Bibliography

- [1] R. J. Davidson, D. C. Jackson, and C. L. Larson. "Human Electroencephalography," in *Handbook of Psychophysiology*, 2nd ed., J. T. Cacioppo, L. G. Tassinary and G. G. Berntson, Eds. Cambridge University Press, 2000.
- [2] H. H. Jasper. "The ten-twenty electrode system of the International Federation." *Electroencephalogr. Clin. Neurophysiol.*, vol. 10, pp. 371-375, 1958.
- [3] E. S. Goldensohn, A. D. Legatt, S. Koszer, and S. M. Wolf. *Goldensohn's EEG interpretation: Problems of Overreading and Understanding*. 2nd ed., Armonk, 1999.
- [4] J. Malmivuo, and R. Plonsey. *Bioelectromagnetism: Principles and Applications of Bioelectric and Biomagnetic Fields*. New York: Oxford University Press, 1995.
- [5] The human brain, image. Internet: <http://sciencealive.wikispaces.com/Human+Brain>. [Sept. 2009.]
- [6] G. L. Krauss, and R. S. Fisher. *The John Hopkins Atlas of Digital EEG*. Baltimore: The John Hopkins University Press, 2006.
- [7] B. L. Chia. *Clinical Electrocardiography*. 3rd ed., Singapore: World Scientific Publishing Co. Pte. Ltd., 2000.
- [8] E. Niedermayer. *Electroencephalography: Basic Principles, Clinical Applications, and Related Fields*. Baltimore, MD: Lippincott Williams and Wilkins, 4th ed., 1999.
- [9] A. Crespel, and P. Gelisse. *Atlas of Electroencephalography. Volume 1: Awake and sleep EEG. Activation procedures and Artifacts*. Paris: John Libbey Eurotext, 2005.
- [10] V. Krajca. (1997, April). "Long-Term Electroencephalogram Analysis." ERCIM news. [Online]. no. 29. Available: http://www.ercim.eu/publication/Ercim_News/enw29/kraica.html [May 2014]
- [11] J. M. Sterm, and J. Engel. *Atlas of EEG Patterns*. Lippincott Williams & Wilkins, 2005.
- [12] S. Sanei, and J. A. Chambers. *EEG Signal Processing*. John Wiley & Sons Ltd, 2007.
- [13] W. H. Spriggs. *Essentials of Polysomnography*. Sleep Ed., LLC, 2008.
- [14] S. Chokroverty, R. J. Thomas, and M. Bhaat. *Atlas of Sleep Medicine*. Elsevier, Inc. 2005.

- [15] A. Rechtschaffen, and A. Kales. *A manual of standardized terminology, techniques and scoring system for sleep stages of human subjects*. Brain Inform. Service/Brain Res. Inst., Univ. California, Los Angeles, 1968.
- [16] A. Roebuch, V. Monasterio, E. Geder, M. Osipov, J. Behar, A. Malhotra, T. Penzel, and G. D. Clifford. “A review of signals used in sleep analysis.” *Physiological Measurement*, vol. 35, R1-R57, 2014.
- [17] C. Iber, S. Ancoli-Israel, A. Chesson, and S. F. Quan. *The AASM Manual for the Scoring of Sleep and Associated Events: Rules, Terminology and Technical Specifications*. Westchester, IL: American Academy of Sleep Medicine, 2007.
- [18] M. Thorpy. *The International Classification of Sleep Disorders: Diagnostic and Coding Manual*. Rochester, MN: American Sleep Disorders Association, 1990.
- [19] AASM. *The International Classification of Sleep Disorders: Diagnostic and Coding Manual*. 2nd ed., Darien, IL: American Academy of Sleep Medicine, 2005.
- [20] American Academy of Sleep Medicine. *The International classification of sleep disorders, revised: Diagnostic and Coding Manual*. Westchester: One Westbrook Corporate Center, 2001.
- [21] L. Teofilo, and L. Chiong. *Sleep: a comprehensive handbook*. John Wiley & Sons, Inc., 2006.
- [22] E. M. Mizrahi, and R. A. Hrachovy. *Atlas of Neonatal Electroencephalography*. 3rd ed., Walnut St., Philadelphia, 2004.
- [23] A. Crespel, P. Gelisse, M. Bureau, and P. Genton. *Atlas of Electroencephalography. Volume 2: The Epilepsies. EEG and epileptic syndromes*. Paris: John Libbey Eurotext, 2005.
- [24] L. Lhotska, V. Krajca, J. Mohylova, S. Petranek, and V. Gerla. “EEG Data Mining Using PCA,” in *Data Mining and Medical Knowledge Management. Cases and Applications*, P. Berka, J. Rauch, D. Abdelkader Zighed, Eds. Medical Information Science Reference, Hershey, New York, 2009, pp. 161–180.
- [25] J. Rieger, L. Lhotska, V. Krajca, and M. Matousek. “Application of Quantitative Methods of Signal Processing to Automatic Classification of Long-Term EEG Records,” in *Biological and Medical Data Analysis, LNCS 3337*, Berlin: Springer, 2004, pp. 333-343.
- [26] M. M. Muller, A. Keli, T. Gruber, and T. Elbert. “Processing of affective pictures modulates right-hemispheric gamma band EEG activity.” *Clinical Neurophysiology*, vol. 110, pp. 1913-1920, 1999.
- [27] J. J. B. Allen, J. A. Coan, and M. Nizarian. “Issues and assumptions on the road from raw signals to metrics of frontal EEG asymmetry in emotion.” *Biological Psychology*, vol. 67, pp. 183-218, 2004.

- [28] M. S. Scher. "Automated EEG-sleep analyses and neonatal neurointensive care." *Sleep Medicine*, vol. 5, pp. 533-540, 2004.
- [29] M. Schupp, and C. D. Hanning. "Physiology of sleep." *British Journal of Anaesthesia, CEPD Reviews*, vol. 3(3), pp.69-74, 2003.
- [30] I. Chouvarda, V. Rosso, M. O. Mendez, A. M. Bianchi, L. Parriano, A. Grassi, M. Terzano, and S. Cerutti. "Assessment of the EEG complexity during activations from sleep." *Computer methods and programs in biomedicine*, vol. 104, e16-e28, 2011.
- [31] S. Khalighi, T. Sousa, and G. P. U. Nunes. "Automatic sleep staging: A computer assisted approach for optimal combination of features and polysomnographic channels." *Expert Systems with Applications*, vol. 40, pp. 7046-7059, 2013.
- [32] L. Zoubek, S. Charbonnier, S. Lesecq, A. Buguet, and F. Chapotot. "Feature selection for sleep/wake stages classification using data driven methods." *Biomedical Signal Processing and Control*, vol. 2, pp. 171-179, 2007.
- [33] M. Ronzhina, O. Janousek, J. Kolarova, M. Novakova, P. Honzik, and I. Provaznik. "Sleep scoring using artificial neural networks." *Sleep Medicine Reviews*, vol. 12, pp. 251-263, 2012.
- [34] M. Hanaoka, M. Kobayashi, and H. Yamazaki. "Automated sleep stage scoring by decision tree learning," Engineering in Medicine and Biology Society, in *Proceedings of the 23rd Annual International Conference of the IEEE*, vol. 2, pp.1751-1754, 2001.
- [35] U. Orhan, M. Hekim, and M. Ozer. "EEG signals classification using the K-means clustering and a multilayer perceptron neural network model." *Expert Syst. Appl.*, vol. 38(10), pp. 13475-13481, 2011.
- [36] S. Zhong, and J. Ghosh. "HMMs and coupled HMMs for multi-channel EEG classification." In *IEEE Int. Joint Conf. on Neural Networks*, pp. 1154-1159, May 2002.
- [37] C. Vural, and M. Yildiz. "Ability of Features Extracted from EEG Signals Using Principle Component Analysis." *Journal of Medical Systems*, vol.34, pp. 83-89, Feb. 2010.
- [38] Y. L. Hsu, Y. T. Yang, J. S. Wang, and C. Y. Hsu. "Automatic sleep stage recurrent neural classifier using energy features of EEG signals." *Neurocomputing*, vol. 104, pp. 105-114, 2013.
- [39] V. Bajaj, and R. B. Pachori. "Automatic classification of sleep stages based on the time-frequency image of EEG signals." *Computer methods and programs in biomedicine*, vol. 112, pp. 320-328, 2013.
- [40] B. Koley, and D. Dey, "An ensemble system for automatic sleep stage classification using single EEG signal." *Computers in Biology and Medicine*, vol. 42, pp. 1186-1195, 2012.

- [41] A. Flexer, G. Gruber, and G. Dorffner. "Continuous unsupervised sleep staging based on a single EEG signal," In *Proceedings of the International Conference on Artificial Neural Networks, ICANN '02*, London, UK, Springer-Verlag, pp. 1013-1018, 2002
- [42] P. Van Hese, W. Philips, J. De Koninck, R. Van de Walle, and I. Lemahieu. "Automatic detection of sleep stages using the EEG," Engineering in Medicine and Biology Society, in *Proceedings of the 23rd Annual International Conference of the IEEE*, vol. 2, pp. 1944-1947, Nov. 2002.
- [43] A. Kam, A. Cohen, A. B. Gerva, and A. Tarasiuk. "Detection of K-complexes in sleep EEG using CD-HMM," Engineering in Medicine and Biology Society, in *IEMBS '04, 26th Annual International Conference of the IEEE*, vol. 1, pp. 33-36, Mar. 2005.
- [44] A. Erdamar, F. Duman, and S. Yetkin. "A wavelet and teager energy operator based method for automatic detection of K-complex in sleep EEG." *Expert Systems with Applications*, vol. 39, pp. 1284-1290, 2012.
- [45] N. Acir, and C. Guzelis. "Automatic recognition of sleep spindles in EEG by using artificial neural networks." *Expert Systems with Applications*, vol. 27(3), pp. 451-458, 2004.
- [46] S. Gunes, M. Dursun, K. Polat, and S. Yosunkaya. "Sleep spindles recognition system based on time and frequency domain features." *Expert Systems with Applications*, vol. 38, pp. 2455-2461, 2011.
- [47] T. A. Camilleri, K. P. Camilleri, S. G. Fabri. "Automatic detection of spindles and K-complexes in sleep EEG using switching multiple models." *Biomedical Signal Processing and Control*, vol. 10, pp. 117-127, 2014.
- [48] L. Guo, D. Rivero, J. Dorado, J. R. Rabunal, and A. Pazos. "Automatic epileptic seizure detection in EEGs based on line length feature and artificial neural networks." *Journal of Neuroscience Methods*, vol. 191, pp. 101-109, 2010.
- [49] M. J. A. M. Putten. "Neonatal seizure detection." *Clinical Neurophysiology*, vol. 119, pp. 2417-2418, Nov. 2008.
- [50] B. R. Greene, W. P. Marnane, G. Lightbody, R. B. Reilly, and G. B. Boylan, "Classifier models and architectures for EEG-based neonatal seizure detection." *Physiological Measurement*, vol. 29, pp. 1157-1178, 2008.
- [51] A. Aarabi, R. Grebe, and F. Wallois. "A multistage knowledge-based system for EEG seizure detection in newborn infants." *Clinical Neurophysiology*, vol. 118, pp. 2781-2797, 2007.
- [52] J. Gotman, J. Zhang, B. Rosenblatt, and R. Gottesman. "Automatic seizure detection in newborns and infants," Engineering in Medicine and Biology Society, in *Proceedings of IEEE Annual Conference*, vol. 2, pp. 913-914, 1995.
- [53] J. Gotman, D. Flanagan, B. Rosenblatt, A. Bye, and E. M. Mizrahi. "Evaluation of an automatic seizure detection method for the newborn EEG." *Electroencephalogr. Clin. Neurophysiol.*, vol. 103, pp. 363-369, 1997.

- [54] J. Gotman, D. Flanagan, J. Zhang, and B. Rosenblatt. "Automatic seizure detection in the newborn: methods and initial evaluation." *Electroencephalogr. Clin. Neurophysiol.*, vol. 103, pp. 356-362, 1997.
- [55] P. Celka, and P. Colditz. "Nonlinear nonstationary Wiener model of infant EEG seizures." *IEEE Trans Biomed Eng*, vol. 49, pp. 556-564, 2002.
- [56] P. Zarjam, M. Mesbah, and B. Boashash. "An optimal feature set for seizure detection systems for newborn EEG signals," in *Proceedings of IEEE International Symposium on Circuits and Systems*, vol. 5, pp. 25-28, 2003.
- [57] A. Aarabi, F. Wallois, and R. Grebe. "Automated neonatal seizure detection: A multistage classification system through feature selection based on relevance and redundancy analysis," *Clinical Neurophysiology*, vol. 117, pp. 328-340, 2006.
- [58] W. Deburchgraeve, P. J. Cherian, M. De Vos, R. M. Swarte, J. H. Blok, G. H. Visser, P. Govaert, and S. Van Huffel. "Automated neonatal seizure detection mimicking a human observer reading EEG." *Clinical Neurophysiology*, vol. 119, pp. 2447-2454, 2008.
- [59] P. J. Cherian, W. Deburchgraeve, R. M. Swarte, M. De Vos, P. Govaert, S. Van Huffel, G. H. Visser, "Validation of a new automated neonatal seizure detection system. A clinician's perspective," *Clinical Neurophysiology*, vol. 122, pp. 1490-1499, 2011.
- [60] M. S. Scher, M. Sun, D. A. Steppe, D. L. Banks, R. D. Guthrie, and R. J. Scwabassi. "Comparisons of EEG sleep state-specific spectral values between healthy full-term and preterm infants at comparable postconceptional ages." *Sleep*, vol. 17, pp. 47-51, 1994.
- [61] M. S. Scher, S. G. Dokianakis, M. Sun, D. A. Steppe, R. D. Guthrie, and R. J. Scwabassi. "Computer classification of sleep in preterm and full-term neonates at similar postconceptional term ages," *Sleep*, vol. 19, pp. 18-25, 1996.
- [62] M. S. Scher, B. L. Jones, D. A. Steppe, D. L. Cork, H. J. Seltman, and D. L. Banks. "Functional brain maturation in neonates as measured by EEG-sleep analyses." *Clinical Neurophysiology*, vol. 114, pp. 875-882, 2003.
- [63] M. S. Scher, D. A. Steppe, D. L. Banks, R. D. Guthrie, and R. J. Scwabassi. "Maturational Trends of EEG-Sleep Measures in the Healthy Preterm Neonate." *Pediatric Neurology*, vol. 12, pp. 314-322, 1995.
- [64] I. Korotchikova, S. Connolly, C. A. Ryan, D. M. Murray, A. Temko, B. R. Greene, and G. B. Boylan. "EEG in the healthy term newborn within 12 hours of birth." *Clinical neurophysiology*, vol. 120, pp. 1046-1053, 2009.
- [65] V. Gerla, K. Paul, L. Lhotska, and V. Krajca. "Multivariate analysis of full-term neonatal polysomnographic data." *IEEE Transactions on Information Technology in Biomedicine*, vol. 13, pp. 104-110, 2009.

- [66] V. Gerla, M. Bursa, L. Lhotska, V. Krajca, and K. Paul, "Newborn sleep stages classification using hybrid evolutionary approach." *International Journal of Bioelectromagnetism*, vol. 9, pp. 25-26, 2007.
- [67] A. Piryatinska, G. Terdik, W. A. Woyczynski, K. A. Loparo, M. S. Scher, and A. Zlotnik. "Automated detection of neonate EEG sleep stages." *Computer methods and programs in biomedicine*, vol. 95, pp. 31-46, 2009.
- [68] L. Fraiwan, K. Leweesy, N. Khasawneh, M. Fraiwan, H. Wenz, and H. Dickhaus. "Time Frequency Analysis for Automated Sleep Stage Identification in Fullterm and Preterm Neonates." *Journal of Medical Systems*, vol. 35, pp. 693-702, 2009.
- [69] A. Piryatinska, W. A. Woyczynski, M. S. Scher, and K. A. Loparo. "Optimal channel selection for analysis of EEG-sleep patterns of neonates." *Computer methods and programs in biomedicine*, vol. 106, pp. 14-26, 2012.
- [70] S. Janjarasjitt, M. S. Scher, and K. A. Loparo. "Nonlinear dynamical analysis of neonatal EEG time series: The relationship between sleep state and complexity." *Clinical Neurophysiology*, vol. 119, pp. 1812-1823, 2008.
- [71] V. Krajca, S. Petranek, J. Mohylova, K. Paul, V. Gerla, and L. Lhotska. "Neonatal EEG Sleep Stages Modeling by Temporal Profiles." In *Computer Aided Systems Theory – EUROCAST 2007, LNCS. 4739*, Berlin Heidelberg: Springer, pp. 195-201, 2007.
- [72] V. Radisavljevic Djordjevic V. Gerla, L. Lhotska, and V. Krajca. "EEG Based Sleep Staging in Term Newborns," in *IFMBE Proceedings: World Congress on Medical Physics and Biomedical Engineering*, Heidelberg: Springer, vol. 39, pp. 348-351, 2013.
- [73] J. P. Turnbull, K. A. Loparo, M. W. Johnson, and M. S. Scher. "Automated detection of trace alternant during sleep in healthy full-term neonates using discrete wavelet transform." *Clinical Neurophysiology*, vol. 112, pp. 1893-1900, 2001.
- [74] S. M. Pincus, I. M. Gladstone, and R. A. Ehrenkranz. "A regularity statistic for medical data analysis." *Journal of Clinical Monitoring*, vol. 7, pp. 335-345, 1991.
- [75] S. M. Pincus. "Approximate entropy (ApEn) as a complexity measure." *Chaos*, vol. 5, pp. 110-117, 1995.
- [76] J. L. Rodriguez-Sotelo, A. Osorio-Forero, A. Jimenez-Rodriguez, D. Cuesta-Frau, E. Cirugeda-Roldan, and D. Peluffo. "Automatic Sleep Stages Classification Using EEG Entropy Features and Unsupervised Pattern Analysis Techniques." *Entropy*, vol. 16, pp.6573-6589, 2014.
- [77] C. K. Peng, S. V. Buldyrev, S. Havlin, M. S. Simons, H. Eugene, and A. L. Goldberger. "Mosaic organization of DNA nucleotides." *Physical Review E*, vol. 49, pp. 1658-1689, 1994.

- [78] S. M. Pincus, and R. R. Viscarello. "Approximate entropy: a regularity measure for fetal heart rate analysis." *Obstetrics and Gynecology*, vol. 79, pp. 249–255, Feb. 1992.
- [79] H. Goncalves, A. P. Rocha, D. A. de Campos, and J. Bernardes. "Linear and nonlinear fetal heart rate analysis of normal and acidemic fetuses in the minutes preceding delivery." *Medical & Biological Engineering & Computing*, vol. 44, pp. 847–855, Oct. 2006.
- [80] K. K. Ho, G. B. Moody, C. K. Peng, J. E. Mietus, M. G. Larson, D. Levy, and A. L. Goldberger. "Predicting survival in heart failure case and control subjects by use of fully automated methods for deriving nonlinear and conventional indices of heart rate dynamics." *Circulation*, vol. 96, pp. 842–848, Aug. 1997.
- [81] C. Vaya, J. Rieta, R. Alcaraz, C. Sanchez, and R. Cervigon. "Prediction of atrial fibrillation termination by approximate entropy in the time–frequency domain." in *Proceedings Computers in Cardiology*, pp. 589–592, 2006.
- [82] D. T. Kaplan, M. I. Furman, S. M. Pincus, S. M. Ryan, L. A. Lipsitz, and A. L. Goldberger. "Aging and the complexity of cardiovascular dynamics." *Biophysical Journal*, vol. 59, pp. 945–949, 1991.
- [83] V. Srinivasan, C. Eswaran, and N. Sriraam. "Approximate Entropy-Based Epileptic EEG Detection Using Artificial Neural Networks." *IEEE Transactions on Information Technology in Biomedicine*, vol. 11, pp. 288-259, 2007.
- [84] N. Kannathal, M. L. Choo, U. R. Acharya, and P. K. Sadasivan. "Entropies for detection of epilepsy in EEG." *Computer Methods and Programs in Biomedicine*, vol. 80, pp. 187-194, 2005.
- [85] Z. Zhang, Y. Zhou, Z. Chen, X. Tian, S. Du, and R. Huang. "Approximate entropy and support vector machines for electroencephalogram signal classification." *Neural Regeneration Research*, vol. 8, pp. 1844-1852, 2013.
- [86] Z. Zhang, Z. Chen, Y. Zhou, S. Du, Y. Zhang, T. Mei, and X. Tian. "Construction of rules for seizure prediction based on approximate entropy." *Clinical Neurophysiology*, vol. 125, pp. 1959-1966, 2014.
- [87] V. Esmaeili, M. B. Shamsollahi, N. M. Arefian, and A. Assareh. "Classifying Depth of Anesthesia Using EEG Features, a Comparison," in *Proceedings of the 29th Annual International Conference of the IEEE EMBS*, pp. 4106-4109, 2007.
- [88] U. R. Acharya, O. Faust, N. Kannathal, T. L. Chua, and S. Lazminiarayan. "Non-linear analysis of EEG signals at various sleep stages." *Computer Methods and Programs in Biomedicine*, vol. 80, pp. 37-45, 2005.
- [89] H. Ocak. "Optimal classification of epileptic seizures in EEG using wavelet analysis and genetic algorithm." *Signal Processing*, vol. 88, pp. 1858-1867, 2008.

- [90] H. Ocak. "Automatic detection of epileptic seizures in EEG using discrete wavelet transform and approximate entropy." *Expert Systems with Applications*, vol. 36, pp. 2027-2036, 2009.
- [91] B. R. Greene, S. Faul, W.P. Marnane, G. Lightbody, I. Korotchikova, and G. B. Boylan "A comparison of quantitative EEG seizures for neonatal seizure detection." *Clinical Neurophysiology*, vol. 119, pp. 1248-1261, 2008.
- [92] H. E. Hurst. "Long-term storage capacity of reservoirs." *Trans. Am. Soc. Civ. Eng.*, vol. 116, 1951.
- [93] U. R. Acharya, E. C. P. Chua, O. Faust, T. C. Lim, and L. F. Lim. "Automated detection of sleep apnea from electrocardiogram signals using nonlinear parameters." *Physiological Measurement*, vol. 32, pp. 287-303, 2011.
- [94] T. Costa, D. Galati, and E. Rognoni. "The Hurst exponent of cardiac response to positive and negative emotional film stimuli using wavelet." *Autonomic Neuroscience: Basic and Clinical*, vol. 151, pp. 183-185, 2009.
- [95] P. Watters. "Fractal structure in the electroencephalogram." *Complexity International*, vol. 5, 1998.
- [96] I. Osorio, and M. G. Frei. "Hurst parameter estimation for epileptic seizure detection." *Communications in Information and Systems*, vol. 7, pp. 167-176, 2007.
- [97] H. Sheng, and Y. Chen. "Multifractional property analysis of human sleep EEG signals," in *Proceedings of the ASME 2011 International Design Engineering Technical Conferences and Computers and Information in Engineering Conference*, pp. 323-328, 2011.
- [98] S. A. Hosseini, M-R. Akbarzadeh-T, and M-B. Naghibi-Sistani, "Qualitative and Quantitative Evaluation of EEG Signals in Epileptic Seizure Recognition." *International Journal of Intelligent Systems and Applications*, vol. 6, pp. 41-46, 2013.
- [99] A. El-Kishky. "Assessing Entropy and Fractal Dimensions as Discriminants of Seizures in EEG Time Series," in *The 11th International Conference on Information Sciences, Signal Processing and their Applications: Main Tracks*, pp. 92-96, 2012.
- [100] S. Geng, W. Zhou, Q. Yuan, D. Cai, and Y. Zheng. "EEG non linear feature extraction using correlation dimension and Hurst exponent." *Neurological Research*, vol. 33, pp. 908-912, 2011.
- [101] M. Nurujjman, R. Narayanan, and A. N. Sekar Iyengar. "Comparative study of nonlinear properties of EEG signals of normal persons and epileptic patients." *Nonlinear Biomedical Physics*, vol. 3, 2009.

- [102] R. Runitha, N. Pradhan, and K. V. Padmaja. "Understanding the Neural Mechanism of Sleep using Wavelets and Multifractal Techniques," in *Proceedings of 2011 International Conference on Signal Processing, Communication, Computing and Networking Technologies*, 2011.
- [103] C. Hartley, L. Berthouze, S. R. Mathieson, G. Boylan, J. M. Rennie, N. Marlow, and S. F. Farmer. (2012, Feb.) "Long-Range Temporal Correlations in the EEG Burst of Human Preterm Babies." *PLoS ONE*, 7(2), Available: <http://journals.plos.org/plosone/article?id=10.1371/journal.pone.0031543> [Jun. 2014].
- [104] A. Delorme, and S. Makeig. "EEGLAB: an open source toolbox for analysis of single-trial EEG dynamics including independent component analysis." *Journal of Neuroscience Methods*, vol. 134, pp. 9-21, 2004.
- [105] R. D. Pascual-Marqui, M. Esslen, K. Kochi, and D. Lehmann. "Functional imaging with low-resolution brain electromagnetic tomography (LORETA): a review." *Methods and findings in experimental and clinical pharmacology*, vol. 24, suppl. C:91-95, 2002.
- [106] F. Zanow, and T. R. Knsche. "ASA – Advanced Source Analysis of continuous and event-related EEG/MEG signals." *Brain Topography*, vol. 16, pp. 287-290, 2004.
- [107] A. Schlogl, C. Keinrath, D. Zimmermann, R. Scherer, R. Leeb, and G. Pfurtscheller. "A fully automated correction method of EOG artifacts in EEG recordings." *Clinical Neurophysiology*, vol. 118, pp. 98-104, 2007.
- [108] F. Tadel, S. Baillet, J. C. Moscher, and D. Pantazis. "Brainstorm: A user-friendly application for MEG/EEG analysis." *Computational Intelligence and Neuroscience*, vol. 2011, 2011.
- [109] R. P. W. Duin, P. Juszczak, P. Paclik, E. Pekalska, D. de Ridder, D. M. J. Tax, and S. Verzakov. *PRTTools 4.1, A Matlab Toolbox for Pattern Recognition*. Delft University of Technology, 2007.
- [110] V. Djordjevic, V. Gerla, M. Huptych, L. Lhotska, and V. Krajca, "Multimedia Support in the Field of Interdisciplinary Education," in *Proceedings of 20th EAEEIE Annual Conference*, 2009.
- [111] J. Rieger, L. Lhotska, and V. Krajca. "Automaticka detekce artefaktu v novorozeneckych EEG signalech," *Slovenska spoločnosť pre klinickú neurofyziológiu*, 2005. (in Czech)
- [112] A. G. Correa, E. Laciari, H. D. Patino, and M. E. Valentinuzzi. "Artifact removal from EEG signals using adaptive filters in cascade." *Journal of Physics: Conference Series*, vol. 90, 2007.

- [113] J. L. Kenemans, P. C. M. Molenaar, M. N. Verbaten, and J. L. Slangen. "Removal of the Ocular Artifact from the EEG: A Comparison of Time and Frequency Domain Methods with Simulated and Real Data." *Psychophysiology*, vol. 28, pp. 114-121, Jan. 2007.
- [114] J.S. Barlow, O. D. Creutzfeldt, D. Michael, J. Houchin, and H. Epelbaum. "Automatic adaptive segmentation of clinical EEGs." *Electroencephalogr. Clin. Neurophysiol.*, vol. 51, pp. 512-525, 1981.
- [115] I. T. Jolliffe. *Principal Component Analysis*. Springer, 2002.
- [116] S. G. Mallat. "A theory for multiresolution signal decomposition: The wavelet representation." *IEEE Transactions on Pattern Analysis and Machine Intelligence*, vol. 11, pp. 674-693, Jul. 1989.
- [117] R. R. Coifman, Y. Meyer, S. Quake, and M. V. Wickerhauser. "Signal Processing and compression with wavelet packets", in *Progress in wavelet analysis and applications*, Y. Mayer, S. Rouges, Eds. Gif-sur-Yvette: Edition Frontieres, pp. 77-94, 1993.
- [118] E. A. Lee, and P. Varaiya. *Structure and Interpretation of Signals and Systems*. Addison Wesley, 2003.
- [119] G. J. Miao, and M. A. Clements. *Digital Signal Processing and Statistical Classification*. Artech House, Inc., 2002.
- [120] P. J. Durka. "Time-frequency analyses of EEG." PhD thesis, Institute of Experimental Physics, Warsaw University, Warszawa, Poland, 1996.
- [121] I. Daubechies. *Ten lectures on wavelets*. Philadelphia, Pennsylvania: CBMS-NSF, SIAM, 1992.
- [122] S. Mallat. *A Wavelet Tour of Signal Processing*. California: Academic Press, 1997.
- [123] S. Burrus, *Introduction to Wavelets and Wavelet Transforms*. Prentice Hall, 1997.
- [124] R. O. Duda, P. E. Hart, and D. G. Stork. *Pattern Classification*, 2nd ed., Wiley-Interscience, 2000.
- [125] V. Gerla, V. Djordjevic, L. Lhotska, and V. Krajca. "PSGLab Matlab Toolbox for Polysomnographic Data Processing: Development and Practical Application," in *Proceedings of 10th International Conference on Information Technology and Applications in Biomedicine. IEEE Control Syst Soc*, 2010.
- [126] V. Gerla. "Automated Analysis of Long-Term EEG Signals." PhD thesis, Czech Technical University in Prague, Prague, Czech Republic, 2012.
- [127] V. Gerla, V. Radisavljevic Djordjevic, L. Lhotska: Polysomnographic Data Processing Toolbox for Matlab, registered software, 2011.

- [128] I. H. Witten and E. Frank, “Data Mining: Practical machine learning tools and techniques”, Morgan Kaufmann, San Francisco, 2005.
- [129] V. Djordjevic, N. Reljin, V. Gerla, L. Lhotska, and V. Krajca. “Feature Extraction and Classification of EEG Sleep Recordings in Newborns,” in *Proceedings of the 9th International Conference on Information Technology and Applications in Biomedicine*, 2009.
- [130] J. Lofhede, M. Thordstein, N. Lofgren, A. Flisberg, M. Rosa-Zurera, I. Kjellmer, and K. Lindcrantz. “Automatic classification of background EEG activity in healthy and sick neonates.” *Journal of Neural Engineering*, vol. 7, 2010.
- [131] M. J. A. M. van Putten, and D. L. J. Tavy.” Continuous quantitative EEG monitoring in hemispheric stroke patients using the brain symmetry index.” *Stroke*, vol. 35, pp. 2489-2492, 2004.
- [132] V. Djordjevic, V. Gerla, L. Lhotska, and V. Krajca. “A Decision Support Tool in the Field of Electroencephalography,” in *Proceedings of 10th International Conference on Information Technology and Applications in Biomedicine*, 2010.
- [133] V. Djordjevic V. Gerla, L. Lhotska, V. Krajca, and K. Paul. “Improvements in Processing of Neonatal Sleep Electroencephalographic Recordings,” in *IFMBE Proceedings: World Congress of Medical Physics and Biomedical Engineering*, Berlin: Springer Science+Business Media, pp. 2215-2218. 2009.
- [134] V. Gerla, V. Djordjevic, L. Lhotska, and V. Krajca. “System Approach to Complex Signal Processing Task.,” in *Computer Aided Systems Theory - Revised Selected Papers*, Heidelberg: Springer, pp. 579-586, 2009.
- [135] V. Djordjevic, V. Gerla, M. Huptych, L. Lhotska, and V. Krajca. “The Development of Modules for the Support of Education in the Field of Biomedical Engineering.” *Electronics and Electrical Engineering*, vol. 102, pp. 47-50, 2010.
- [136] C. E. Shannon, W. Weaver. *The mathematical theory of communication*. United States: University of Illinois Press, 1975. (Reprinted with corrections from The Bell System Technical Journal, vol 27, pp. 379-423, 623-656, July, October, 1948.)
- [137] M. Sabeti, S. Katebi, and R Boostani. “Entropy and complexity measures for EEG signal classification of schizophrenic and control participants.” *Artificial Intelligence in Medicine*, vol. 47, pp. 263-274, 2009.
- [138] S.M. Pincus. “Approximate entropy as a measure of system complexity,” in *Proc. Nat. Acad. Sci., USA*, vol. 88, pp. 2297–2301, 1991.
- [139] P. Grassberger, and I. Procaccia. “Measuring the strangeness of strange attractors.” *Physica D: Nonlinear Phenomena*, vol. 9, pp. 189–208, 1983.

- [140] J. P. Eckmann, and D. Ruelle. “Ergodic theory of chaos and strange attractors.” *Rev. Mod. Phys.*, vol. 57, pp. 617–656, 1985.
- [141] L. Li, W. Chen, X. Shao, and Z. Wang. “Analysis of amplitude-integrated EEG in the newborn based on approximate entropy.” *IEEE Transactions on Biomedical Engineering*, vol. 57, pp. 2459-2466, 2010.
- [142] J. S. Richman, and J. R. Moorman. “Physiological time-series analysis using approximate entropy and sample entropy.” *Am J Physiol Heart Circ Physiol*, vol. 278(6), pp. H2039–H2049, Jun. 2000.
- [143] R. Kohavi. “A study of cross-validation and bootstrap for accuracy estimation and model selection,” in *Proceedings of the 14th international joint conference on Artificial intelligence - Volume 2, IJCAI’95*, San Francisco, CA, USA, Morgan Kaufmann Publishers Inc., pp. 1137–1143 1995.
- [144] K. H. Chon, C. G. Scully, and S. Lu. “Appropriate entropy for all signals.” *IEEE Engineering in Medicine and Biology Magazine*, vol. 28, pp. 18-23, 2009.
- [145] B. B. Mandelbrot, and J. R. Wallis. “Robustness of the rescaled range R/S in the measurement of non-cyclic long run statistical dependence.” *Water Resources Research*, vol. 5, pp. 967-988, 1969.