

**Bachelor Project**



**Czech  
Technical  
University  
in Prague**

**F3**

**Faculty of Electrical Engineering  
Department of Control Engineering**

## **Brake-by-wire control system platform development**

**Milan Mitterko**

**Supervisor: doc. Ing. Tomáš Haniš, Ph.D.  
Field of study: Cybernetics and Robotics  
May 2022**



## I. Personal and study details

Student's name: **Mitterko Milan** Personal ID number: **474441**  
Faculty / Institute: **Faculty of Electrical Engineering**  
Department / Institute: **Department of Control Engineering**  
Study program: **Cybernetics and Robotics**

## II. Bachelor's thesis details

Bachelor's thesis title in English:

**Brake-by-wire control system platform development**

Bachelor's thesis title in Czech:

**Stavba demonstrátoru řídicího systému brzd**

Guidelines:

Highly automated and autonomous vehicles advance motion control systems start to be limited by conventional braking systems. Braking system architecture in line with Drive-by-Wire philosophy will be proposed and verification hardware platform developed in this thesis. Following points will be addressed:

1. Get familiar with passenger vehicles braking systems
2. Selection of suitable hardware components for brake-by-wire demonstration platform
3. Development of demonstration platform
4. Development of brake-by-wire control algorithm
5. Verification of brake-by-wire system

Bibliography / sources:

- [1] Dieter Schramm, Manfred Hiller, Roberto Bardini – Vehicle Dynamics – Duisburg 2014
- [2] Hans B. Pacejka - Tire and Vehicle Dynamics – The Netherlands 2012
- [3] Robert Bosch GmbH - Bosch automotive handbook - Plochingen, Germany : Robet Bosch GmbH ; Cambridge, Mass. : Bentley Publishers
- [4] Mark A. Yoder, Jason Kridner - BeagleBone Cookbook: Software and Hardware Problems and Solutions; ISBN-13: 978-1491905395, O'Reilly Media, Inc.

Name and workplace of bachelor's thesis supervisor:

**doc. Ing. Tomáš Haniš, Ph.D. Department of Control Engineering FEE**

Name and workplace of second bachelor's thesis supervisor or consultant:

Date of bachelor's thesis assignment: **26.01.2021** Deadline for bachelor thesis submission: **20.05.2022**

Assignment valid until:

**by the end of summer semester 2022/2023**

\_\_\_\_\_  
doc. Ing. Tomáš Haniš, Ph.D.  
Supervisor's signature

\_\_\_\_\_  
prof. Ing. Michael Šebek, DrSc.  
Head of department's signature

\_\_\_\_\_  
prof. Mgr. Petr Páta, Ph.D.  
Dean's signature

## III. Assignment receipt

The student acknowledges that the bachelor's thesis is an individual work. The student must produce his thesis without the assistance of others, with the exception of provided consultations. Within the bachelor's thesis, the author must state the names of consultants and include a list of references.

\_\_\_\_\_  
Date of assignment receipt

\_\_\_\_\_  
Student's signature



## Acknowledgements

I would like thank my supervisor doc. Ing. Tomáš Haniš, Ph.D. for his help, guidance and understanding throughout this thesis. Next, I would like to thank professors Bc. Zdeněk Houf and Ing. Tomáš Čenský, Ph.D. for their help in the platform development, specifically those mechanically oriented parts, for which I do not have enough experience, skills or knowledge, to deal on my own.

Finally I would like to thank my family and friends for their unwavering emotional support and/or a good advice.

## Declaration

I, Milan Mitterko, hereby declare that this thesis is a product of my own work and that to the best of my knowledge, all informations sources have been listen in accordance with the methodical instructions for observing the ethical principles in the preparation of a university thesis.

In Prague, 20. May 2022

## Abstract

The end goal of this thesis is to create a functioning brake-by-wire demonstration platform, with a verified brake-by-wire control algorithm. First, the platform architecture, used parts and their final assembly is presented. Then, the platform preconfiguration and the developed control algorithm controlling both the brake-by-wire system, and the rest of the platform, is described. Finally, the verification of both the platform and its algorithm is done.

**Keywords:** brake-by-wire, drive-by-wire, control system platform, demonstration platform

**Supervisor:** doc. Ing. Tomáš Haniš,  
Ph.D.  
ČVUT FEL,  
Karlovo náměstí 13,  
Praha 2

## Abstrakt

Cílem této práce je vytvoření funkčního demonstrátoru brzdění po drátě, s verifikovaným řídicím algoritmem. Nejdříve je prezentována architektura platformy, její použité části a konečné sestavení. Následně, je popsána předkonfigurace platformy a vytvořený řídicí algoritmus, který řídí jak systém brzdění po drátě, tak i zbytek platformy. Nakonec přichází na řadu jak verifikace platformy, tak i jejího algoritmu.

**Klíčová slova:** brzdění po drátě, řízení po drátě, řídicí systémová platforma, demonstrační platforma

# Contents

<b>Acronyms</b>	<b>1</b>	3.3.2 Motor controller . . . . .	17
<b>1 Introduction</b>	<b>3</b>	3.3.3 Accumulator and charger . . .	19
<b>2 Braking systems overview</b>	<b>5</b>	3.3.4 Battery isolator switch . . . . .	19
2.1 Hydraulic braking systems . . . . .	5	3.4 Chassis dynamometer . . . . .	20
2.2 Electric braking systems . . . . .	7	3.4.1 Induction motor and flexible coupling . . . . .	20
<b>3 Brake-by-wire control system platform development</b>	<b>11</b>	3.4.2 Variable frequency drive . . . .	21
3.1 Platform architecture . . . . .	11	3.4.3 Residual current circuit breaker with overcurrent protection . . . . .	22
3.2 Braking system . . . . .	12	3.5 Platform control unit . . . . .	22
3.2.1 Hydraulic disc brakes . . . . .	12	3.5.1 Raspberry Pi . . . . .	22
3.2.2 Digital servo . . . . .	13	3.5.2 Raspberry Pi power supply and power socket . . . . .	23
3.2.3 Pressure sensor . . . . .	14	3.5.3 Interface board . . . . .	24
3.2.4 Digital servo power supply . .	15	3.5.4 Interface board power supply	25
3.2.5 Miniature circuit breaker . . . .	16	3.6 Platform assembly . . . . .	25
3.3 Driving system . . . . .	16	<b>4 Platform control algorithm development</b>	<b>27</b>
3.3.1 Bicycle wheel and wheel hub motor . . . . .	16	4.1 Platform preconfiguration . . . . .	27
		4.1.1 Motor controller preconfiguration . . . . .	27

4.1.2 Variable frequency drive preconfiguration . . . . .	28
4.1.3 Raspberry Pi preconfiguration	29
4.2 Platform control algorithm description . . . . .	30
<b>5 Platform control algorithm verification</b>	<b>33</b>
5.1 Braking system control verification . . . . .	33
5.2 Driving system control verification	34
5.3 Chassis dynamometer control verification . . . . .	36
<b>6 Conclusion</b>	<b>39</b>
<b>A Bibliography</b>	<b>41</b>
<b>B Attached CD contents</b>	<b>45</b>



## Figures

2.1 Hydraulic brake system construction diagram [2] . . . . .	6	3.11 The battery isolator switch . . . . .	20
2.2 Break-by-wire construction diagram [3] . . . . .	8	3.12 The used induction motor with its coupling . . . . .	20
3.1 Block diagram of the platform architecture . . . . .	12	3.13 The used VFD with its Faraday cage . . . . .	21
3.2 Hydraulic disc brakes overview . . . . .	13	3.14 The RCBO ABB DS201 B16 A30[17] . . . . .	22
3.3 Digital servo and its conversion mechanism . . . . .	13	3.15 The Raspberry Pi and its accessories . . . . .	22
3.4 Relative pressure sensor and its recommended wiring . . . . .	14	3.16 The Raspberry Pi power supply and its socket . . . . .	23
3.5 Use of the custom made adapter . . . . .	15	3.17 The interface board . . . . .	24
3.6 The used digital servo power supply[7] . . . . .	15	3.18 The interface board power supply MEANWELL HDR-15-24[22] . . . . .	25
3.7 The used miniature circuit breaker[8] . . . . .	15	3.19 The platform . . . . .	26
3.8 The wheel hub motor with mounted disc brakes and relative pressure sensor . . . . .	16	3.20 The metal cage . . . . .	26
3.9 The used BLDC motor controller with its programing interface . . . . .	17	4.1 The motor controller programming software UI . . . . .	28
3.10 Accumulator with its charger . . . . .	19	4.2 Raspberry Pi OS . . . . .	29
		4.3 Overview of the algorithm/Simulink model UI . . . . .	31
		4.4 Overview of the rest of the Simulink model . . . . .	31

5.1 Bicycle angular speed dependence on braking pressure .....	33
5.2 Bicycle wheel angular speed plot	34
5.3 Accumulator output behavior ..	35
5.4 Phase current waveform forward	35
5.5 Phase current waveform backwards .....	36
5.6 Wheel hub motor torque dependence on phase currents ....	37

## Tables

3.1 The motor controller used control pins .....	18
4.1 The list of specifically set parameters .....	28
4.2 The list of used control terminals	29



## Acronyms

- BBW - Brake-by-wire
- DBW - Drive-by-wire
- HBS - Hydraulic braking system
- MCB - Miniature circuit breaker
- RCBO - Residual current circuit breaker with overcurrent protection
- PWM - Pulse width modulation
- BLDC - Brushless direct current
- UART - Universal asynchronous receiver-transmitter
- EMI - Electromagnetic interference
- RAM - Random-access memory
- UI - User interface
- VFD - Variable frequency drive





# Chapter 1

## Introduction

With the advent of electric vehicles becoming increasingly more mainstream, a boom of x-by-wire technologies has occurred, where systems which typically use mechanical linkages or hydraulics to achieve their functions, use electrical signals instead. This results in a number of advantages. No x-by-wire system is probably more controversial than the brake-by-wire system, which is a system where the vehicle brakes are controlled by electrical means. To study this type of system more closely, this thesis has set out to develop a brake-by-wire control system platform, and a control algorithm to match it. The thesis is divided into four chapters, according to its goals.

Chapter 2 serves as a brief overview of currently and widely used hydraulic braking system and the quite new brake-by-wire system. After that, chapter 3 explains the physical development of the BBW control system platform. Following, is chapter 4 describing the development of the desired BBW control algorithm (sometimes in his thesis also referred to as platform control algorithm, since the algorithm ended up controlling more than just the brakes). And finally, chapter 5 verifies the workings of the developed control algorithm.



## Chapter 2

### Braking systems overview

To properly understand the differences between conventional braking systems and BBW, overview of both types of braking systems is in order. Since purely mechanical braking systems are obsolete nowadays, only the hydraulic braking systems are going to be mentioned as a representative of conventional braking systems. There are also of course pneumatic braking systems that use air as the transfer medium for the brake force. Those are however quite similar to the hydraulic ones, and as such will not be explained any further.

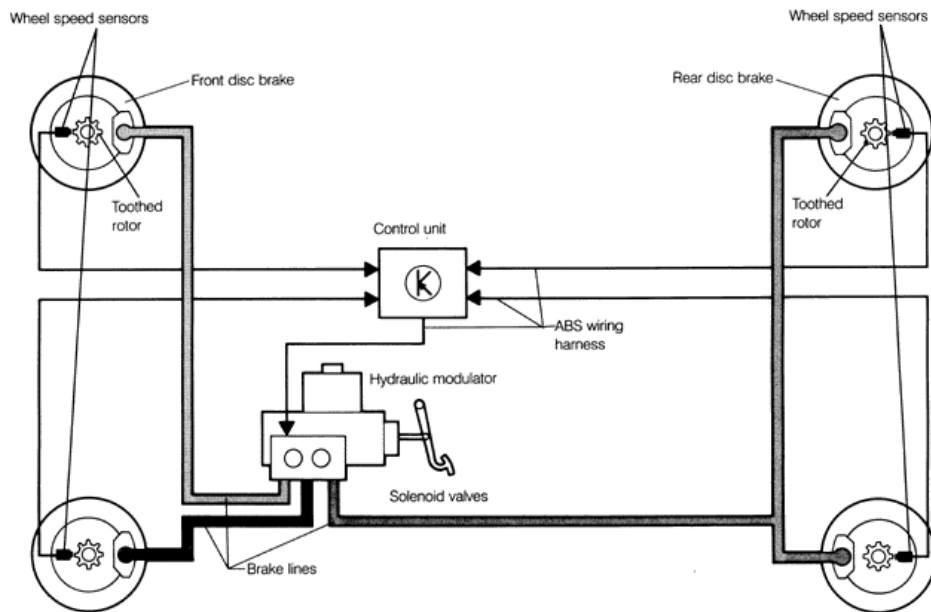
#### 2.1 Hydraulic braking systems

The idea behind hydraulic braking systems is simple. To transfer force from the brake lever or brake pedal to the braking mechanism, through fluid. This is a step-up from HBS predecessors which used mechanical medium like levers or steel cables, to transfer the brake force. Compared to those predecessors HBS has following advantages

- greater efficiency at transferring brake force which results in shorter stopping distance,
- requires less force from the driver for the same braking force and
- have less need for maintenance since they are fully closed.

To avoid skidding, it is mandatory nowadays for automobile braking systems to have anti-lock braking system implemented. This system prevents the wheels from locking up during braking, thereby maintaining tractive contact with the road surface and allowing the driver to maintain more control over the vehicle. [1] Because of that, the hydraulic braking system discussed in this section will include ABS.

Diagram of the discussed system can be seen on the Figure 2.1.



**Figure 2.1:** Hydraulic brake system construction diagram [2]

Its components will be now explained in greater detail:

**Brake pedal** — Acts as a human-machine interface through which driver applies force to the input of the master cylinder.

**The master cylinder** — The cylinder converts applied force to a pressured flow of a the brake fluid. This flow then flows through a hydraulic modulator and brake lines into brakes. When ABS is not engaged the modulator does not affect the flow at all. Braking system basically acts as if the modulator is not part of the system.

**Hydraulic modulator** — The hydraulic modulator is a device allowing the control unit to control the brake fluid pressure, using solenoid valves. Those are valves that are controlled by an electric signal. In case of detected brake lock-up, the modulator closes of the master cylinder and according to



the commands of the control unit starts to control the flow of the brake fluid. This effectively strips the driver of brake control, but stops the brake lock-up. Once the lock-up has stopped, the modulator returns control to the driver by opening the solenoid valve leading to the master cylinder.

**Brake lines** — They are formed by pipes and hoses and they transfer pressurized brake fluid into the wheel brakes. As it can be seen in the Figure 2.1 not every wheel-brake has its individual brake line, since the rear wheel-brakes have shared brake line. There also exist other variants, where even the front brakes have shared lines or where brake lines are shared by brakes on the same side.

**Wheel brakes** — Most of the wheel hydraulic brakes nowadays are disc brakes. These brakes use the friction between the disc and brake pad pressed by pressurized piston to slow down the wheel. However there are still vehicles where at least the rear wheels are braked by drum brakes. Those work on the principle of brake shoes or brake pads pressing outward against a brake drum, and with that creating friction that slows down the wheel.

**Wheel speed sensor and toothed rotor** — Typically used wheel speed sensor is a variable reluctance sensor which measures changes in magnetic reluctance. When a tooth of the rotating metal toothed rotor gets close to the sensor, the magnetic reluctance changes. The sensor detects said change and by how often this change happens, the angular speed of the wheel is determined.

**Control unit** — This unit is the system part implementing ABS. It reads measured angular speed of the wheels and in case of detected brake lock-up, commands the hydraulic modulator how to control the brake fluid flow to stop the lock-up.

## 2.2 Electric braking systems

Electronic braking system, also known as brake-by-wire, in theory completely eliminates hydraulic components from the braking system and replaces them with electric ones. However there are hybrids, where the brakes themselves are either hydraulic or even pneumatic, but are controlled by electricity. In that sense ABS is also form of brake-by-wire.

The advantages of the brake-by-wire systems over conventional ones are as follows

- faster response times which result in shorter stopping distances,
- lower operating noises and vibrations,
- taking up less space and weight,
- less damaging to the environment since they do not use any corrosive braking fluid and
- to implement ABS there is no need for and extra control unit.

General diagram of BBW can be seen on the Figure 2.2.

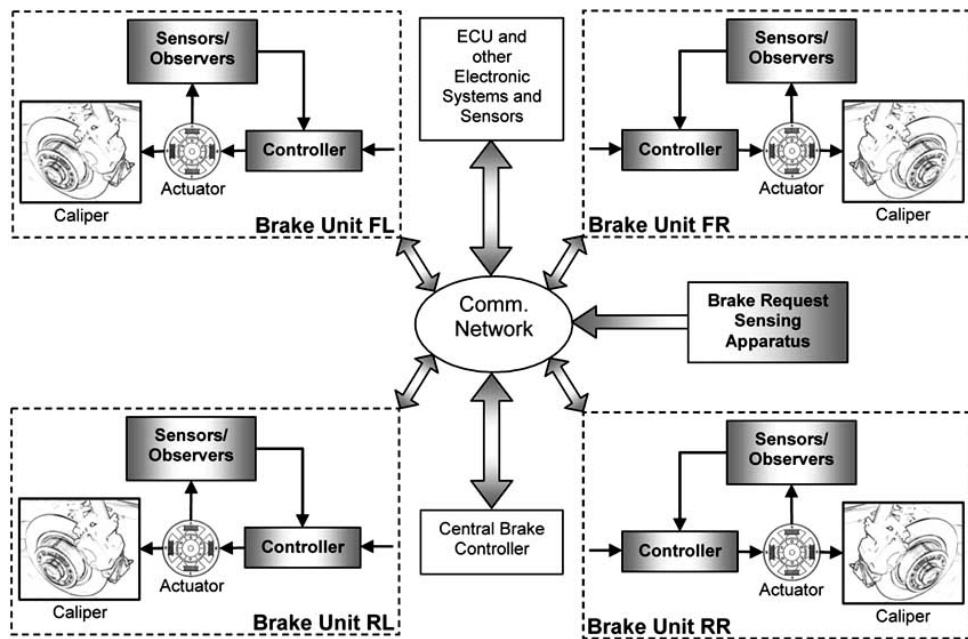


Figure 2.2: Break-by-wire construction diagram [3]

**Brake request sensing apparatus** — Force applied to brake pedal by driver is here converted to an electric signal. It also simulates pedal resistance to being pressed, which can be modulated according to the drivers wishes.

**Communication network** — As the name suggests it is a network managing communication between the system components. The network must have redundancies so a critical signal being transferred can not get lost or corrupted along the way.

**ECU and other Electronic Systems and Sensors** — This component is responsible for evaluating driver applied force and measured wheel speed from wheel speed sensors. Based on that evaluation it outputs brake commands to the central brake controller, that can be in some implementations a part of the ECU itself. And as before, sensor redundancies are a must to mitigate possible sensor failures. Plus to be extra sure, a redundant ECU itself is also welcome.

**Central brake controller** — Based upon the commands from the ECU, the controller issues brake commands for each of the four brake units.

**Brake unit** — The brake unit is responsible for engaging the brake actuator according to the brake commands received over the network. These actuator can be electrical, hydraulic or pneumatic based, as mentioned above. The unit can also have its own local feedback controller.



## Chapter 3

### Brake-by-wire control system platform development

This chapter will open with the discussion of the platform architecture 3.1, where the platform will be broken down to four systems and a brief description of these systems will be provided. Following are four sections 3.2, 3.3, 3.4 and 3.5, where each system and their parts will be described in greater detail. At the end of this chapter is the platform assembly section 3.6, describing how the platform and all aforementioned systems were assembled together.

#### 3.1 Platform architecture

As is implied by the thesis title, the platform will require a **braking system** controlled by electrical means. To demonstrate its effects, there needs to be a **driving system**, which would drive the wheel (one is enough for the demonstrative purposes) to be braked by the braking system. This system is effectively a drive-by-wire system. Since in real-life the driven wheel is normally subjected to a force interaction between it and surface upon which it rolls, a **chassis dynamometer** had to be created. This dynamometer simulates the force interaction by loading the braked wheel with the desired torque. Finally, a **platform control unit** was developed, to control all the aforementioned systems according to the user command and the platform sensors outputs. All four of these systems gave rise to the platform architecture shown in figure 3.1, where each system architecture and their mutual interactions can be seen.

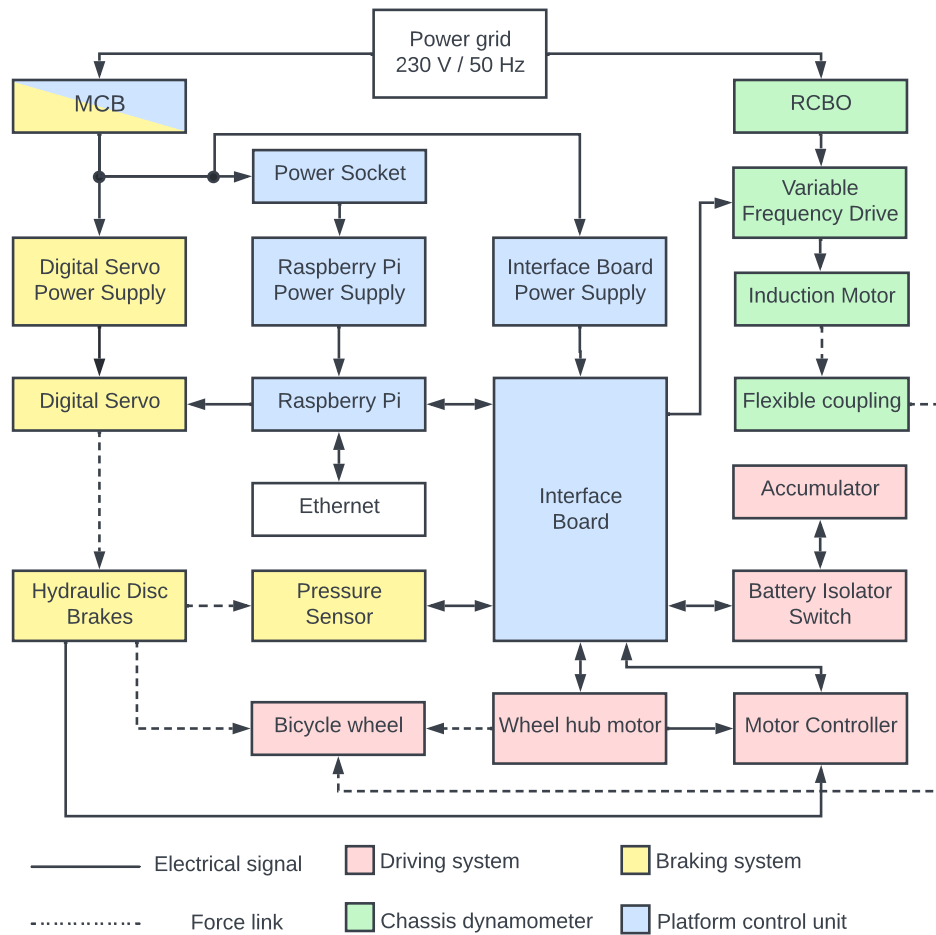


Figure 3.1: Block diagram of the platform architecture

## 3.2 Braking system

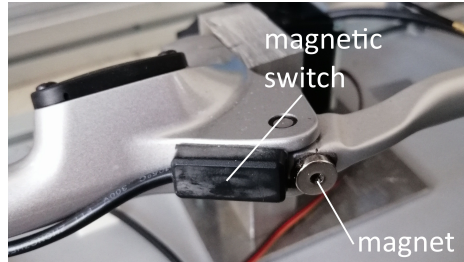
### 3.2.1 Hydraulic disc brakes

Unfortunately, electric brakes which would fit onto the braked bicycle wheel, were impossible to find. That resulted in making the braking system a hydraulic-electric hybrid, where the braking torque exerted onto the braked wheel is exerted by hydraulic disc brakes. These hydraulic brakes are run-of-the-mill trekking bicycle brakes by Shimano, and are shown in figure 3.2a.

Their brake lever is equipped with a magnetic switch, shown in figure 3.2b, whose purpose is to notify the motor controller powering the braked wheel, that brakes were engaged and that it can engage dynamic braking. By measuring the conductivity between the outputs of the magnetic switch, it was identified that the switch acts as a closed switch when the lever is squeezed. Otherwise, the switch acts as an open switch.



(a) : Whole hydraulic disc brakes system[4]

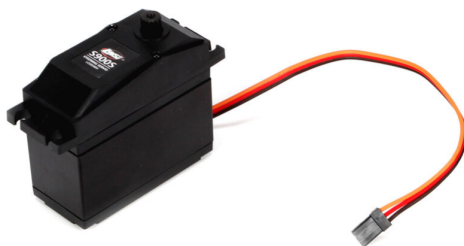


(b) : Closer look at the magnetic switch

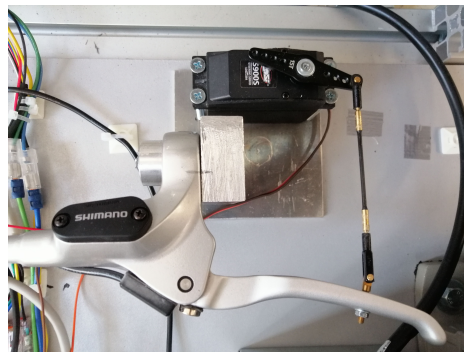
**Figure 3.2:** Hydraulic disc brakes overview

### 3.2.2 Digital servo

To implement the desired brake control by electrical means, the brake lever of the hydraulic disc brakes is physically linked to a digital servo Losi S900S, shown in figure 3.3a, by a custom made slider-crank mechanism shown in figure 3.3b. This mechanism translates the rotational motion of the servo into the brake lever squeeze.



(a) : The used digital servo[5]



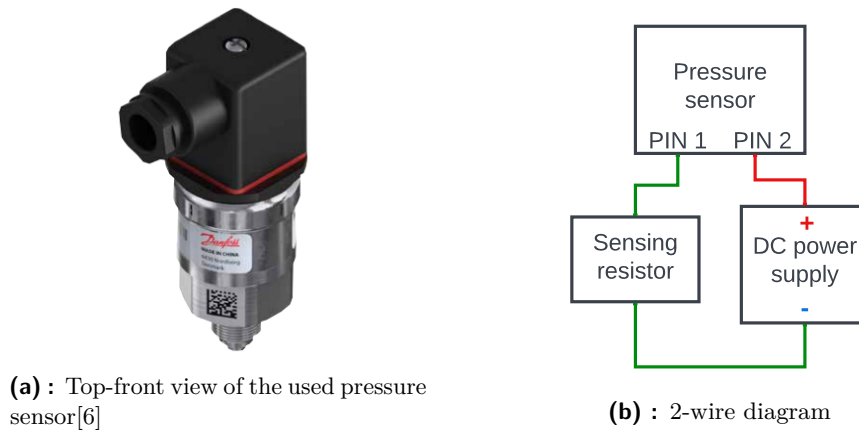
(b) : The custom made slider-crank mechanism

**Figure 3.3:** Digital servo and its conversion mechanism

It was tested, that this servo can be powered by a DC voltage in range from 6.0 V up to 7.4 V, and that it can be controlled by a 50 Hz PWM signal

with amplitude voltage value of 3.3 V. 5% of duty cycle of this PWM signal corresponds to  $0^\circ$  servo rotation, while 10% corresponds to  $180^\circ$ . However, given the dimensions of the above mentioned slider-crank mechanism, the effective range of the servo, in this case, is capped at about  $72^\circ$ , corresponding to 7% duty cycle.

### 3.2.3 Pressure sensor



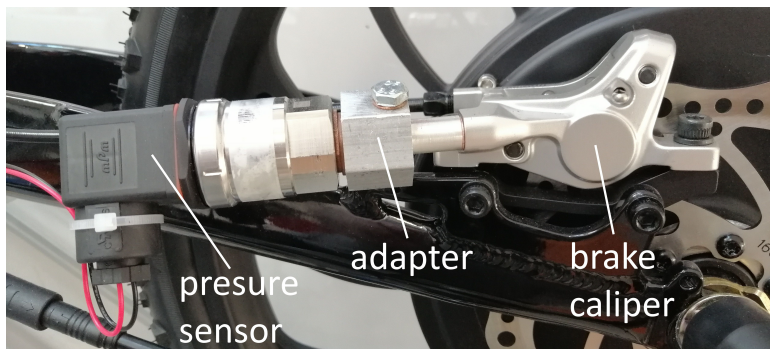
**Figure 3.4:** Relative pressure sensor and its recommended wiring

The purpose of this relative pressure sensor Danfoss MBS 3000-3211-A1AB04-0, which can be seen in figure 3.4a, is to measure the real-life value of the braking pressure developed by the brake caliper of the hydraulic disc brakes, for the purpose of controlling the braking intensity. Measuring the pressure directly, instead of predicting it, then compensates for the changes in braking pressure caused by the brake fluid temperature change.

The relative pressure measuring range of this sensor is from 0 up to 160 bars, and the pressure measured in this range maps onto an electrical current output in range from 4 mA up to 20 mA. This type of output requires the sensor to be wired according to the wiring diagram in figure 3.4b, where its power supply voltage must be in range from 9 VDC up to 32 VDC.[6]

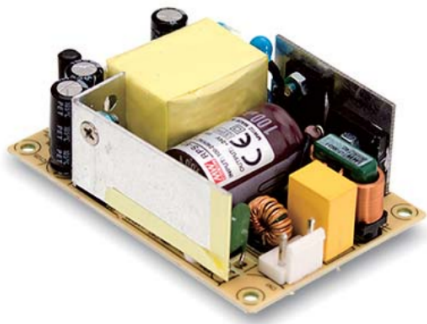
In figure 3.5 can be seen that the sensor is mounted onto the pressure relief valve of the above mentioned brake caliper, through the use of a custom made adapter.





**Figure 3.5:** Use of the custom made adapter

### 3.2.4 Digital servo power supply



**Figure 3.6:** The used digital servo power supply[7]



**Figure 3.7:** The used miniature circuit breaker[8]

The power supply MEANWELL RPS-45-7.5 was chosen as the power supply of the digital servo for two reasons: (1) its adjustable voltage output values intersect with the supply voltage values of the digital servo and (2) it has relatively high electrical current output of 5.95 A to feed the previously stated servo, which is observed to easily consume an electrical current up to the value of 3 amps. Its own supply voltage ranges from 80 VAC up to 264 VAC, and because of that, it is powered from the 230 VAC / 50 Hz power grid.[7]

### 3.2.5 Miniature circuit breaker

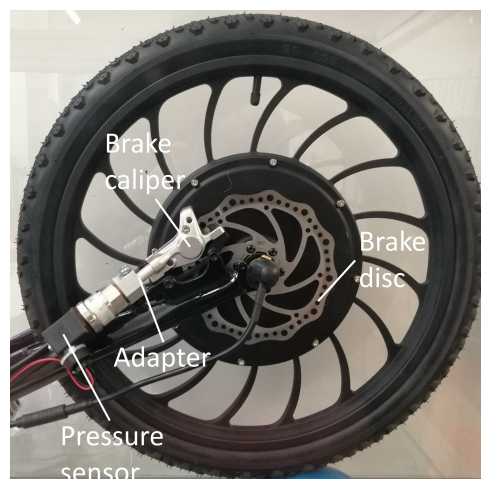
The digital servo power supply is not powered directly from the 230 VAC / 50 Hz power grid, but through a miniature circuit breaker ABB S201M-B16, which can be seen in figure 3.7. Its ratings are rather standard. It has a tripping characteristic B, rated voltage 230 VAC, rated current 16 A and rated short-circuit capacity 6 kA. [8]

As can be seen in figure 3.1 this circuit breaker does not serve as an overcurrent protection and switch only for the braking system, but also for the platform control unit. The MCB is shared, since there is no practical reason to protect or switch each system independently.

## 3.3 Driving system

### 3.3.1 Bicycle wheel and wheel hub motor

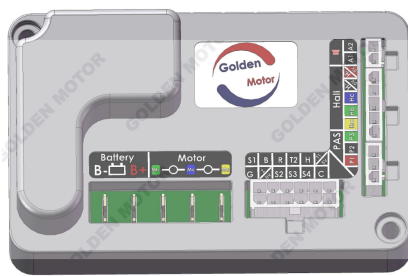
Since its inception, the platform was suppose to be as simple as possible and relatively low-powered. It is because of these requirements, that the braked wheel is a bicycle wheel with a wheel hub motor mounted within. This wheel, shown in figure 3.8, has a rim size of 20" and is fitted with a standard bicycle tire pressurized to about 2 atm.



**Figure 3.8:** The wheel hub motor with mounted disc brakes and relative pressure sensor

As for the hub motor itself, it is a 3-phase BLDC motor HBS-48V1000W from the e-bike conversion kit ProKit 901, manufactured by Golden Motor. As the motor name implies, it is rated for 1000 W @ 48 VDC, however its maximum permissible supply voltage is 60 VDC.[9] To determine its rotor position, the motor uses three hall-effect sensors placed 120° apart. These sensors operate at 5 VDC supply voltage and output 23 five volt squares waves per one full rotation (360°) of the motor.

### 3.3.2 Motor controller



(a) : The motor controller



Model:PI-200E  
(for external controller)

(b) : The UART programming interface

**Figure 3.9:** The used BLDC motor controller with its programming interface

For the sake of compatibility, the motor controller used to power the used wheel hub motor, was taken from the same conversion kit as the motor. This controller, see figure 3.9a, has a model name BAC-281P, and it is designed to power 3-phase BLDC motors with power ratings from 200 W up to 1000 W and with exactly three 5 VDC hall-effect sensors placed either 60° or 120° apart. Its rated controller supply voltage is in range from 24 VDC up to 60 VDC, its rated continuous electrical current is 25 A and its peak current is 50 A. Also, its commutation is of trapezoidal character.[10][11]

Regrettably, no datasheet or user guide, which would sufficiently describe the behavior of the motor controller pins, was found. Because of that, this section presents table 3.1, which serves as this sufficient description of at least those controller pins, which are used in this thesis. The description was put together from the found user guides and our measurements.[11][12]

The controller has its own programming software, discussed in Section 4.1.1. To use this software, the motor controller must be connected over a serial programming interface shown in figure 3.9b, to the computer where the

software is installed. Important to note, if the controller is connected over the UART interface to the computer, its supply pins B+ and B- must not be connected to any voltage source. Doing otherwise could result in damaging the controller.

Pin name	Description
B-	Negative terminal. Defines common ground for all the voltages on the motor controller.
B+	Positive terminal.
Ma	Phase signal 'A'.
Mb	Phase signal 'B'.
Mc	Phase signal 'C'.
H-/0V	Hall negative terminal.
H+/5V	Hall positive terminal.
Ha	Hall signal 'A'
Hb	Hall signal 'B'
Hc	Hall signal 'C'
Z/0V	Ground. Shares the electric potential with the pin B- and H-/0V.
T1/5V	Throttle positive signal.
T2	Throttle signal. $0 \div \sim 0.8 \text{ V} = \text{controller is in error state}$ $\sim 0.8 \text{ V} \div \sim 4.5 \text{ V} = 0 \div 100 \% \text{ speed}$
R	Reverse signal. $0 \text{ V} = \text{do nothing}$ $5 \text{ V} = \text{reverse rotation}$
B	Brake signal. $0 \text{ V} = \text{stop driving the motor and engage dynamic braking}$ $5 \text{ V} = \text{do nothing}$
S1	Spare pins pulled up to the voltage on the pin B+.
G	Softswitch. Externally shorted with the S1 pin. $0 \text{ V} = \text{turned off motor controller}$ supply voltage = turned on motor controller

**Table 3.1:** The motor controller used control pins

### 3.3.3 Accumulator and charger

The choice to choose an accumulator as the motor controller power supply stems from wanting to make the platform closer to a real-life electric car and to be able to demonstrate recuperation. The used accumulator, shown in figure 3.10a, has a nominal voltage of 48 VDC, nominal capacity of 9 Ah, nominal discharge current of 25 A and maximal discharge current of 50 A for a maximum of 15 s.



(a) : The accumulator with marked connectors



(b) : The accumulator charger[13]

**Figure 3.10:** Accumulator with its charger

The charging voltage of the described accumulator is 54.6 VDC and its maximum charging current is 5 A. According to these requirements charger STC-8108LD, see figure 3.10b, has been bought. This charger can be powered by an alternating voltage from 100 V up to 240 V, and it outputs DC voltage of 54.6 V and DC current of 2.5 A.[13] Czech user manual for this charger can be found in citation[14].

### 3.3.4 Battery isolator switch

This battery isolator switch MSW-BS1250A, shown in figure 3.11, is used to quickly and safely disconnect the accumulator from the motor controller. It is rated for DC voltage in range from 12 V to 60 V, for continuous electrical current up to 275 A and for peak current up to 350 A. As such it is more than adequate for its designated purpose in this thesis.[15]

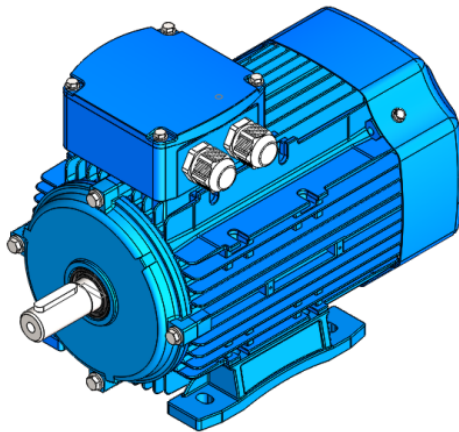


Figure 3.11: The battery isolator switch

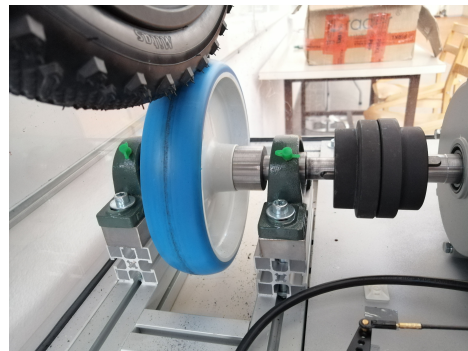
## 3.4 Chassis dynamometer

### 3.4.1 Induction motor and flexible coupling

The desired torque loading the braked bicycle wheel is generated by a 3-phase induction motor, shown in figure 3.12a, with a model number 3A90L-B3. According to its technical plate, it is rated for a power of 1.5 kW, angular speed of 1440 rpm and rated current of 5.7 A, all per supply voltage of 230 VAC / 50 Hz and connected in star connection.



(a) : The used induction motor



(b) : Torque of the bottom wheel is transferred onto the top wheel

Figure 3.12: The used induction motor with its coupling

The transfer of the generated desired torque, onto the braked wheel, is done by a custom made flexible coupling, shown in figure 3.12b.

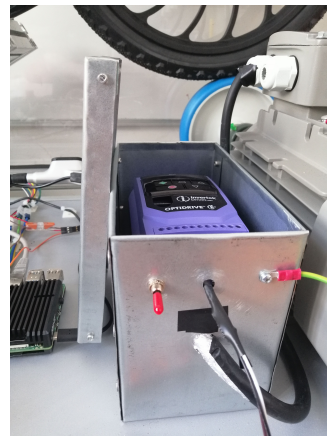
### 3.4.2 Variable frequency drive

Similarly to the BLDC motor of the driving system, the induction motor of the chassis dynamometer also needs some device to drive it. That device is a variable frequency drive INVERTEK ODE-3-120070-1F12 shown in figure 3.13a. It is a versatile frequency drive capable of driving 3-phase induction, BLDC and PM motors, up to 1.5 kW. Its output voltage can reach up to 230 VAC and its maximum electrical output current is 7 amps. It can do all this while being supplied with a 1-phase voltage in range from 200 VAC up to 240 VAC, per 50 Hz.[16]

The drive control terminals used in this thesis are numbered 1, 2, 3, 6 and 7, and their configuration is described in the programming section 4.1.2.



(a) : The used VFD



(b) : Faraday cage for the VFD

**Figure 3.13:** The used VFD with its Faraday cage

Unfortunately, the drive introduces considerable electromagnetic interference to the electrical devices around it. This caused an issue with the interface board, where the data sent over the SPI became corrupted. To solve this issue, the frequency drive is enclosed in a metal box, which acts as a Faraday cage. Next, to filter out the EMI spreading over the wires connected between the drive control terminals and the interface board, 1 mH chokes were connected in series with the mentioned wires. The same metal box is fitted a toggle switch, which turns the drive on/off.

### 3.4.3 Residual current circuit breaker with overcurrent protection

Similar to the braking system, the chassis dynamometer also has an over-current protection, plus it also has a protection against leakage current to ground, both in one device. This device is residual current circuit breaker with overcurrent protection ABB DS201 B16 A30, shown in figure 3.14. It has a tripping characteristic of type B, and it is rated for electrical current of 16 amps, AC voltage of 230 V, short-circuit capacity 10 kA and residual current 30 mA.[17]



Figure 3.14: The RCBO ABB DS201 B16 A30[17]

## 3.5 Platform control unit

### 3.5.1 Raspberry Pi



(a) : RasPi enclosed within the heatsink[18]



(b) : 32 GB SD card[19]

Figure 3.15: The Raspberry Pi and its accessories



The Raspberry Pi acts as a sort of programmable controller, setting the values of its outputs, according to the user reference and platform sensors outputs. The Pi was chosen because it has a power source independent of its communicating interface and because it is supported by Simulink Coder, which allows to program it in Simulink.[20]

Specifically, the RasPi model used in this thesis, is Raspberry Pi 4 Model B with 4 GB RAM. For the sake of cooling, it is enclosed in a passive cooler Joy-it ARMOR Case BLOCK and as a storage device it uses SanDisk MicroSDHC 32GB Extreme Mobile Gaming micro SD card. Its setup is discussed in its programming section 4.1.3.

### 3.5.2 Raspberry Pi power supply and power socket

The supply used to power the Pi is Raspberry Pi 15W USB-C Power Supply. It accepts input voltage in range from 96 VAC to 264 VAC, and it outputs 5.1 VDC / 3.0 ADC.[21] To easily apply supply voltage on to the power supply input without any modifications to it, an E type power socket ABB M1174, shown in figure 3.16b, is used.



(a) : The power supply Raspberry Pi 15W USB-C



(b) : Type E socket[21]

**Figure 3.16:** The Raspberry Pi power supply and its socket

### 3.5.3 Interface board

This board, shown in figure 3.17, accepts DC input voltage in range from 18 V up to 35 V and has a relatively small maximum electrical current consumption of about 0.3 A. Next, it measures following physical quantities: braking pressure generated by the brake caliper, accumulator output voltage and electrical current, currents flowing through the wheel hub motor and the hall sensor outputs of the hub motor. All these quantities it measures in a form of 0 to 3.3 V analog voltages, which are then measured by an ADC, communicating with the RasPi.

On the other hand, the interface board also serves as a digital-to-analog voltage translator, so the Raspberry Pi could control analog inputs of the motor controller and VFD, with its PWM voltages. Finally, it also serves as a logic level translator from 3.3 V to 5 V, to control motor controller reverse pin. Or from 3.3 to 15 V, to control reverse pin of the VFD.

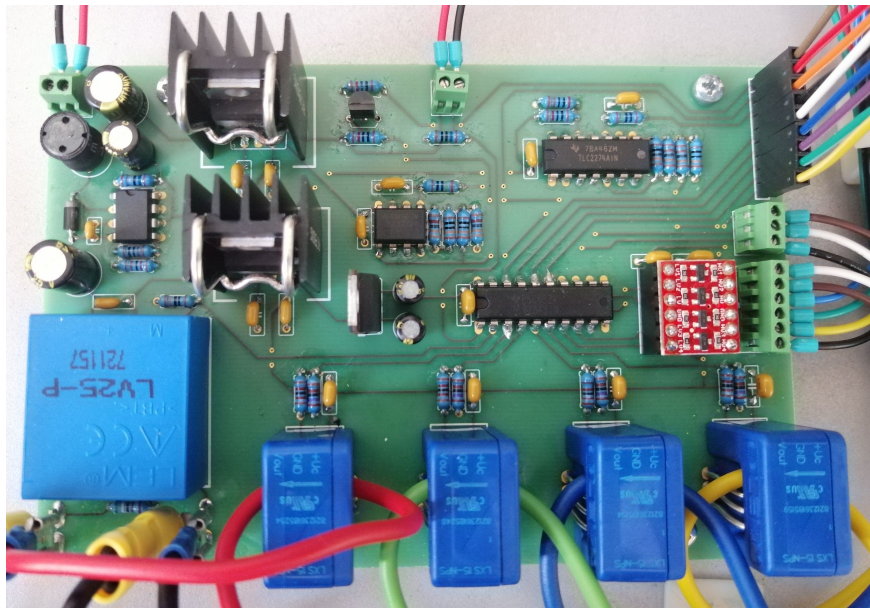


Figure 3.17: The interface board

The electrical diagram and board scheme of the board can be found in the attached contents in zip file named *IB.zip*.

### 3.5.4 Interface board power supply



**Figure 3.18:** The interface board power supply MEANWELL HDR-15-24[22]

Since the interface board requires very little electrical current to work, and its supply voltage should be in range from 18 V up to 35 V, the power supply MEANWELL HDR-15-24 was chosen. This supply has an adjustable output voltage in range from 21.6 VDC up to 29 VDC, and its maximum electrical current output is 0.63 amps. As for its own supply voltage, the supply can be easily powered from the 230 VAC / 50 Hz power grid.[22]

## 3.6 Platform assembly

The platform base, see figure 3.19, is built out of several aluminum ALUTEC beams. Part of this base is covered with a silver painted plywood, upon which most of the platform parts are located. The exceptions are a wheel hub motor and an extended induction motor shaft, which are located behind the plywood. The whole platform is then enclosed for the sake of protection in an aluminium cage with plexiglass walls and ceiling as can be seen in figure 3.20. Outside the cage are led two cables: one to connect the platform into a 230 V / 50 Hz power grid and second to connect it into an Ethernet network.

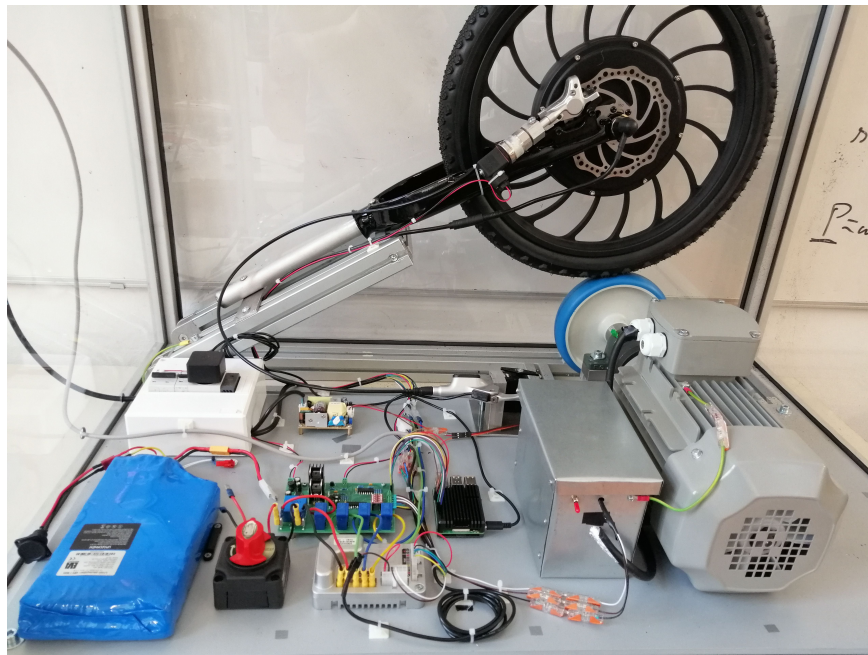


Figure 3.19: The platform

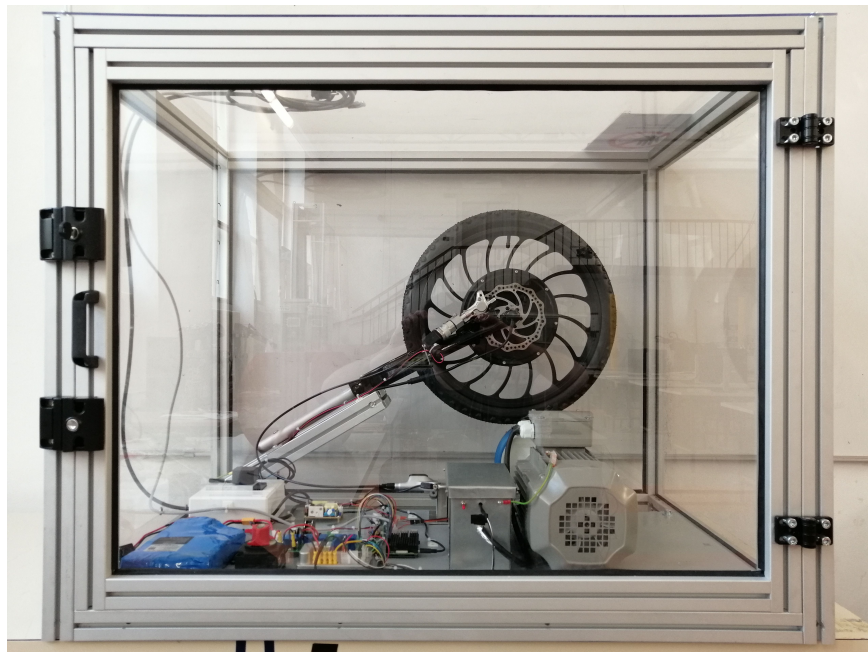


Figure 3.20: The metal cage

## Chapter 4

### Platform control algorithm development

As mentioned in the introduction 1, the desired BBW control algorithm, is also referred to as platform control algorithm, since this algorithm ended up not only controlling the BBW system, but also the DBW and the chassis dynamometer.

First section 4.1 of this chapter will discuss the preconfiguration of the platform, required for the intended function of the algorithm. Second section 4.2 will describe the developed platform control algorithm, and what to expect of it.

#### 4.1 Platform preconfiguration

##### 4.1.1 Motor controller preconfiguration

Many of the motor controller parameters such as maximum allowed electrical current, default motor direction rotation, acceleration rate and etc., are configurable by a programming software called Personalized Settings Unit v1.1, see figure 4.1. Czech user manual for this software can be found in citation [11]. For the purposes of this thesis, the controller configuration was kept to the one preset by the store in which the controller was bought, as is shown in figure 4.1.

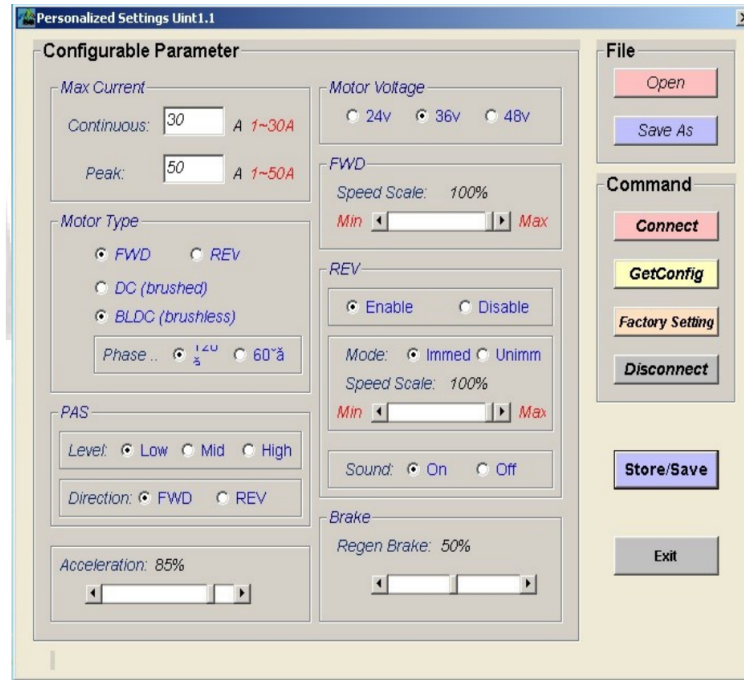


Figure 4.1: The motor controller programming software UI

#### 4.1.2 Variable frequency drive preconfiguration

The used frequency drive comes with a preinstalled firmware, in which plenty of parameters can be configured, using control buttons of the drive.[16] Most of these parameters were left to its default values. Those parameters, which were specifically set, can be found in table 4.1. As for the configuration of the used control terminals, their configuration can be seen in table 4.2.

Parameter number	Description	Set value
P-01	Maximum Speed Limit	1440 rpm
P-08	Motor Rated Current	5.7 A
P-10	Motor Rated Speed	1440 rpm
P-60 - Index 1	Motor Overload Management	1: Current Limit Reduction

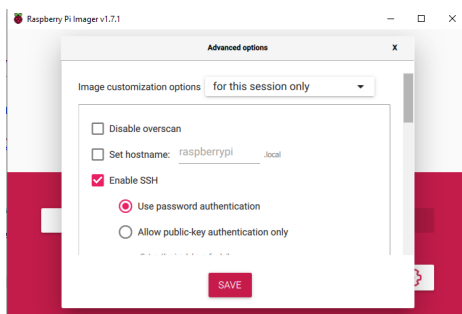
Table 4.1: The list of specifically set parameters

Terminal number	Signal type	Configuration
1	24 VDC power supply max 100 mA	Fixed configuration as a voltage output.
2	Digital input Logic 0 = 0 V ÷ 4 V DC Logic 1 = 8 V ÷ 30 V DC	The drive starts to drive the motor., if the logic 1 is set.
3	Digital input Logic 0 = 0 V ÷ 4 V DC Logic 1 = 8 V ÷ 30 V DC	The motor rotation direction reverses, if the logic 1 is set.
6	Analog input 0 V ÷ 10 V DC	Controls the motor speed. 0 V = min speed 10 V = max speed
7	Ground	Ground for the control terminal signals.

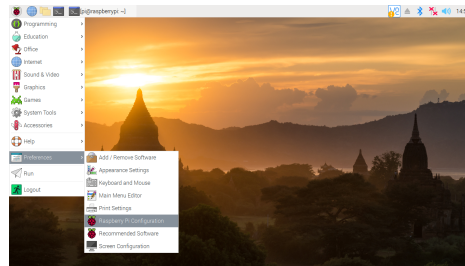
**Table 4.2:** The list of used control terminals

### 4.1.3 Raspberry Pi preconfiguration

To function at all, the Raspberry Pi requires an operating system on its SD card. The operating system of choice in this case is the Debian-based Raspberry Pi OS 32 bit, see figure 4.2, with desktop environment and with a release date 28-05-2021. Its installation was done using Raspberry Pi Imager, according to the guide found at [23].



**(a)** : When installing the OS, it is a good idea to allow SSH by default



**(b)** : OS desktop

**Figure 4.2:** Raspberry Pi OS

To be able to run the Simulink model on the Pi, the Simulink Support

Package for Raspberry Pi Hardware must be installed on both the Pi and the programming computer and then synchronized. This process is thankfully quite self-explanatory, but a brief guide can be found at [24]. Be advised that RasPi used in this thesis, Raspberry Pi 4 Model B, is supported by Matlab from version 2020a and higher. The 2021a version is the version used in this thesis. Also the SPI should be enabled, to properly work with the ADC on the interface board.

## 4.2 Platform control algorithm description

The algorithm is implemented in the form of a Simulink model named *raspi\_main.slx*. It can control five different following quantities, through the use of dashboard blocks shown in figure 4.3:

- **Hub Motor Direction** [1] - Controls the rotational direction of the driven hub motor, through the motor controller. Off = Forward rotation. On = Backwards.
- **Hub Motor Throttle** [%] - Controls the throttle voltage of the motor controller driving the hub motor. Which results in controlling the hub motor speed itself.
- **Dynamometer Motor Direction** [1] - Controls the rotational direction of the chassis dynamometer motor. Off = Forward rotation acting against the default rotation direction of the hub motor. On = Backwards.
- **Dynamometer Motor Throttle** [%] - Controls the chassis dynamometer motor speed, through the variable frequency drive.
- **Braking Intensity** [%] - Controls the digital servo rotation, and by that the squeeze of the brake lever and by it the braking pressure.

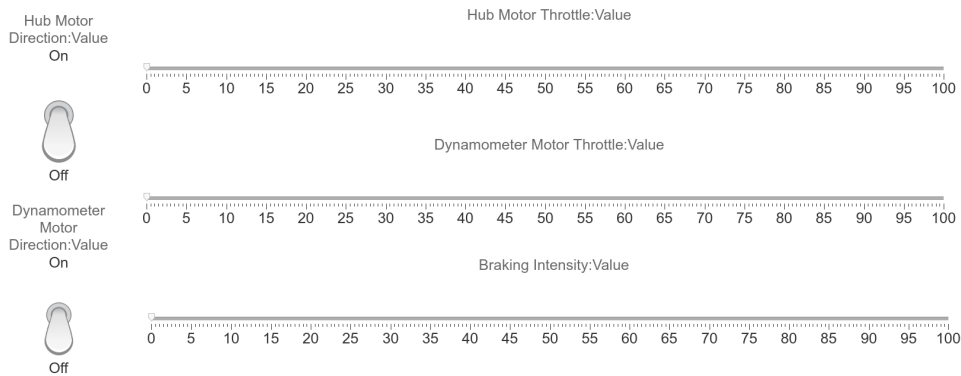
These dashboard blocks send the values set by the user, into the constant blocks hidden inside subsystem block named *User Set Output*, shown in figure 4.4. There, the values are compensated for static nonlienarities, if needed, and sent into Raspberry Pi library blocks, controlling chosen pins of the Pi.

As for the input part of the algorithm, the algorithm periodically reads, over SPI, analog voltages measured by the interface board ADC. This reading is done in the subsystem named *ADC Measurements*, also shown in figure

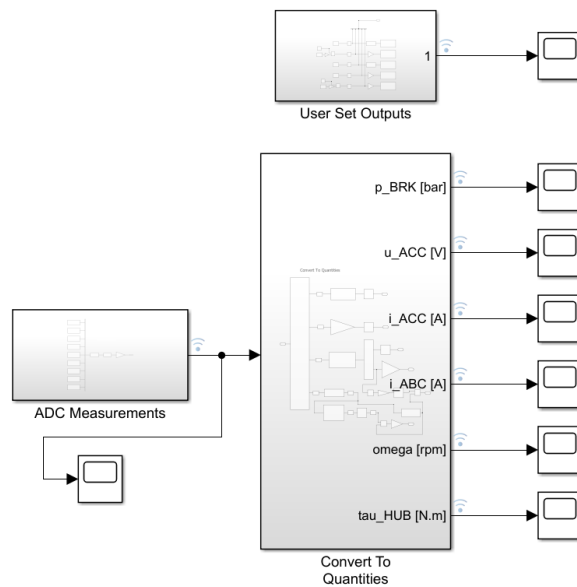


4.4. From the measured analog voltages, following list of physical quantities is calculated, by the subsystem named *Convert To Quantities*, as can be seen in figure 4.4:

- **Braking pressure**  $p_{BRK}$  [bar]
- **Accumulator output voltage**  $u_{ACC}$  [V]
- **Accumulator output current**  $i_{ACC}$  [A]
- **Wheel hub motor phase current**  $i_A, i_B$  and  $i_C$  [A]
- **Wheel hub motor angular speed**  $\omega$  [rpm]
- **Wheel hub motor electromagnetic torque**  $\tau_{HUB}$  [N.m]



**Figure 4.3:** Overview of the algorithm/Simulink model UI



**Figure 4.4:** Overview of the rest of the Simulink model

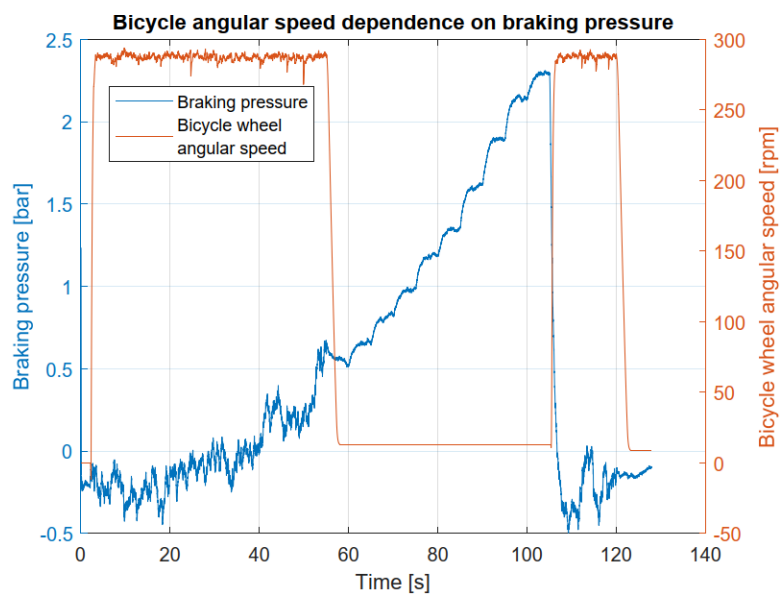


# Chapter 5

## Platform control algorithm verification

This chapter will in short, verify that the developed platform control algorithm, controls and monitors all the platform systems as intended.

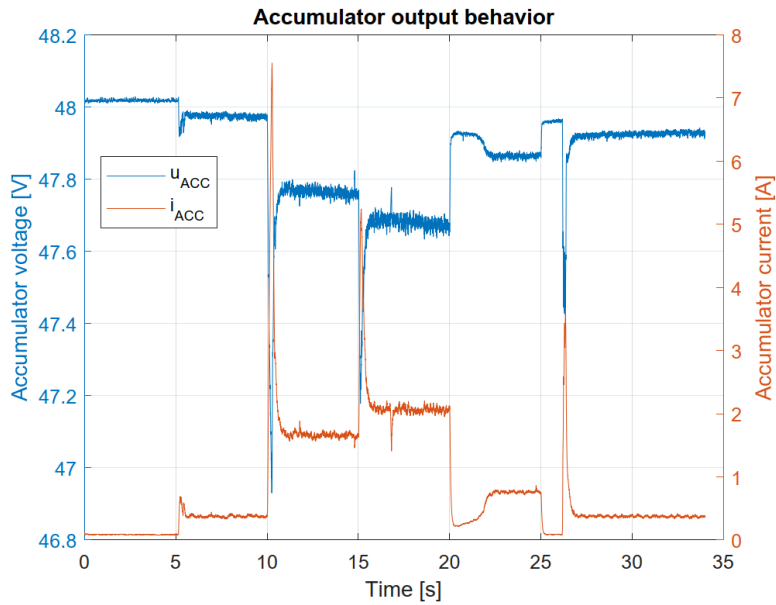
### 5.1 Braking system control verification



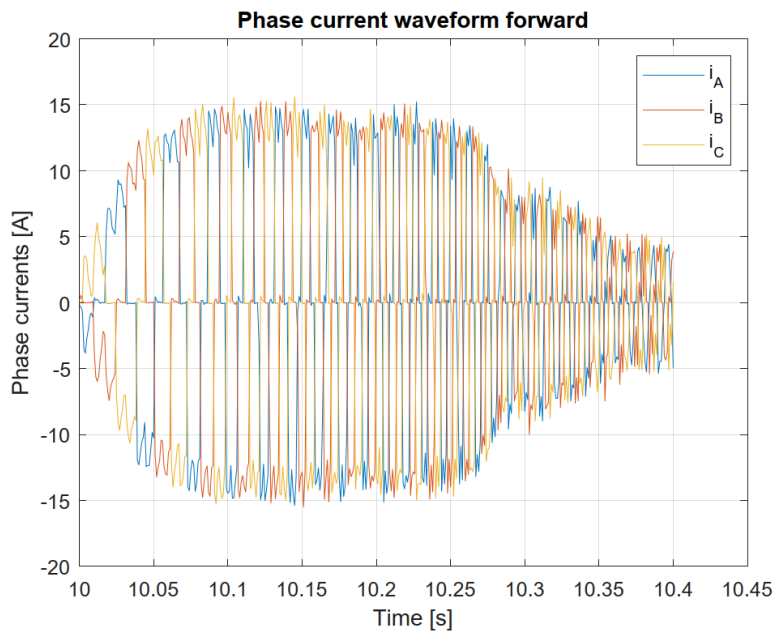
**Figure 5.1:** Bicycle angular speed dependence on braking pressure



The behavior of the accumulator output voltage and its electrical current, corresponding to the speed curve in figure 5.2, can be seen in figure 5.3. This figure shows, that when increasing the hub motor speed, the accumulator loses its voltage, but supplies more current.

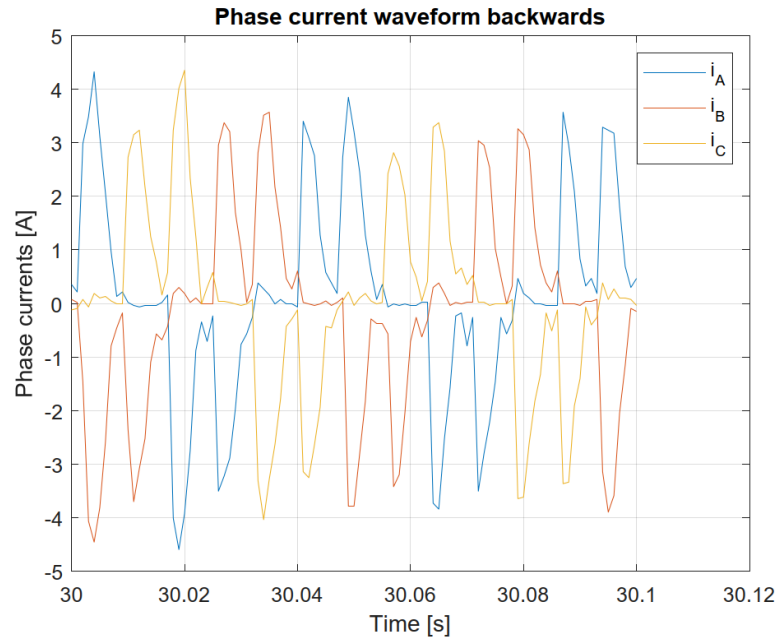


**Figure 5.3:** Accumulator output behavior



**Figure 5.4:** Phase current waveform forward

As for the phase currents flowing into the BLDC motor of the drive-by-wire system, their trapezoidal characteristic can be seen in figure 5.4. Comparing the ordering of the currents in figure 5.4 and in figure 5.5 reveals that the reverse rotation is achieved by swapping phases between two electrical currents.



**Figure 5.5:** Phase current waveform backwards

### 5.3 Chassis dynamometer control verification

The figure 5.6 shows that in the timeframe between 20 secs and about 25.5 secs, both the wheel hub motor current amplitude and its torque has increased in value. It was in that exact same timeframe, when the control algorithm output named dynamometer motor throttle, was also increased in value. From the general knowledge of the BLDC motors behavior, it can be stated that this torque increase proves that the chassis dynamometer truly loads the BLDC motor, as desired.

Important to note, the developed control algorithm can also run the dynamometer motor in reverse direction, which causes it to act as a booster for the hub motor. The issue with this configuration is, that in that case, the hub motor starts to wiggle up and down on the dynamometer flexible coupling, making the whole platform vibrate beyond acceptable limit. Because of that, the dynamometer should not be currently used in reverse rotation.

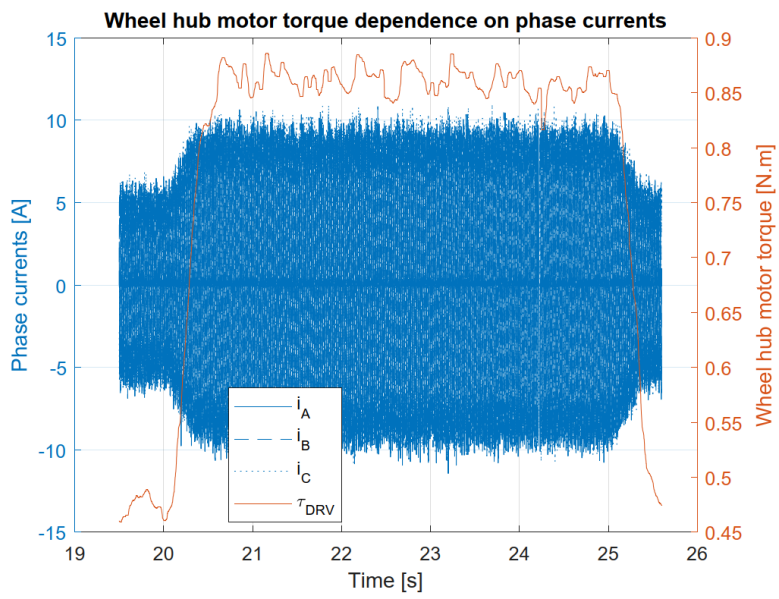


Figure 5.6: Wheel hub motor torque dependence on phase currents







## Chapter 6

### Conclusion

This thesis offered a brief explanation of advantages, that the brake-by-wire systems offer, over the currently widely used hydraulic brake systems. After that, the development of the demonstrative brake-by-wire system platform was discussed.

In more detail, the platform architecture was showcased and after that, the used platform parts were described, including their assembly. This was followed by the chapter explaining the developed platform control algorithm, and the platform preconfiguration, which was required to make this algorithm work. Finally there was the verification stage, where it was shown that both the demonstration platform and its control algorithm, are working as desired.

In the future, a mathematical model of this platform can be identified and with its use, a more complex brake-by-wire or drive-by-wire control algorithm, can be developed.



## Appendix A

### Bibliography

- [1] Wikipedia. *Anti-lock braking system* — *Wikipedia, The Free Encyclopedia*. <http://en.wikipedia.org/w/index.php?title=Anti-lock%20braking%20system&oldid=1036973303>. [Online; accessed 06-August-2021]. 2021.
- [2] B.A.P. van Duifhuizen et al. *Modeling, design and control of an individual wheel actuated brake system*. English. D&C. Traineeship report. - DC 2014.052. Eindhoven University of Technology, 2014.
- [3] Reza Hoseinnezhad and Alireza Bab-Hadiashar. “Recent Patents on Measurement and Estimation in Brake-By-Wire Technology”. In: *Recent Patents on Electrical Engineering 2* (Jan. 2009), pp. 54–64. DOI: 10.2174/1874476110902010054.
- [4] *Shimano BL-T605(L) + BR-T605(F)*. Accessed: 2022-04-26. 2015. URL: <https://brzdy.heureka.cz/shimano-bl-t605-l-plus-br-t605-f/#prehled/>.
- [5] *S900S 1/5 Scale Steering Servo with Metal Gear 5IVE-T*. Accessed: 2022-04-26. 2017. URL: <https://www.horizonhobby.com/product/s900s-1-5-scale-steering-servo-with-metal-gear-5ive-t/LOSB0884.html>.
- [6] *Pressure transmitter for general industrial purposes MBS 3000 and MBS 3050*. Accessed: 2022-04-26. 2021. URL: <https://assets.danfoss.com/documents/156946/AI308930736185en-000201.pdf>.
- [7] *RPS-45.pdf*. Accessed: 2022-04-26. 2015. URL: <https://www.czech-meanwell.cz/fotky10575/fotov/RPS-45.pdf>.
- [8] *S201M-B16*. Accessed: 2022-04-26. 2022. URL: <https://new.abb.com/products/cs/2CDS271001R0165/s201m-b16>.









## Appendix B

### Attached CD contents

1. IB.zip - zipped Eagle project describing the wiring and board scheme of the interface board.
2. raspi\_main.slx - Simulink model where the platform control algorithm is implemented.